

Product data sheet

Specifications



Limit switch, Limit switches XC Standard, XCMD, metal end plunger, 1NC+1 NO, snap, M12

XCMD2110M12

Main

Range of product	Telemecanique Limit switches XC Standard
Series name	Standard format
product or component type	Limit switch
Device short name	XCMD
Sensor design	Miniature
Body type	Plug-in body
Head type	Plunger head
Material	Metal
body material	Zamak
Head material	Zamak
Fixing mode	By the body
Movement of operating head	Linear
Type of operator	Spring return plunger metal
Type of approach	Vertical approach, 1 direction
Number of poles	1
Contacts type and composition	1 C/O
Contact operation	Snap action

Complementary

Switch actuation	On end
Electrical connection	Male connector M12, 4 pins
Contacts insulation form	Za
Positive opening	Without
Minimum force for tripping	8.5 N
Minimum actuation speed	0.01 m/min
Maximum actuation speed	0.5 m/s
[I _e] rated operational current	1.5 A at 240 V, AC-15 conforming to EN/IEC 60947-5-1 appendix A 0.1 A at 250 V, DC-13 conforming to EN/IEC 60947-5-1 appendix A
[I _{th}] conventional enclosed thermal current	3 A
[U _i] rated insulation voltage	250 V (pollution degree 3) conforming to IEC 60947-5-1
Maximum resistance across terminals	25 mOhm conforming to IEC 60255-7 category 3

[Uimp] rated impulse withstand voltage	2.5 kV conforming to IEC 60664 2.5 kV conforming to IEC 60947-1
Short-circuit protection	4 A cartridge fuse, type gG
Electrical durability	5000000 cycles, DC-13, 24 V, 3 W, operating rate <60 cyc/mn, load factor: 0.5 conforming to IEC 60947-5-1 appendix C 5000000 cycles, DC-13, 48 V, 2 W, operating rate <60 cyc/mn, load factor: 0.5 conforming to IEC 60947-5-1 appendix C 5000000 cycles, DC-13, 120 V, 1 W, operating rate <60 cyc/mn, load factor: 0.5 conforming to IEC 60947-5-1 appendix C
Mechanical durability	10000000 cycles
Width	30 mm
Height	50 mm
Depth	16 mm
net weight	0.085 kg

Environment

Shock resistance	25 gn for 18 ms conforming to IEC 60068-2-27
Vibration resistance	5 gn (f= 10...500 Hz) conforming to IEC 60068-2-6
IP degree of protection	IP66 conforming to IEC 60529 IP67 conforming to IEC 60529 IP68 conforming to IEC 60529
IK degree of protection	IK06 conforming to EN 62262
Electrical shock protection class	Class I conforming to IEC 61140 Class I conforming to NF C 20-030
Ambient air temperature for operation	-25...70 °C
Ambient air temperature for storage	-40...70 °C
protective treatment	TC
Product certifications	UL CSA CCC
Standards	EN/IEC 60947-5-1 EN/IEC 60204-1 CSA C22.2 No 14 UL 508

Packing Units

Unit Type of Package 1	PCE
Number of Units in Package 1	1
Package 1 Height	1.7 cm
Package 1 Width	6.1 cm
Package 1 Length	5.3 cm
Package 1 Weight	84.0 g
Unit Type of Package 2	S02
Number of Units in Package 2	100
Package 2 Height	15 cm
Package 2 Width	30 cm
Package 2 Length	40 cm
Package 2 Weight	9.05 kg

Unit Type of Package 3	P06
Number of Units in Package 3	1600
Package 3 Height	75 cm
Package 3 Width	60 cm
Package 3 Length	80 cm
Package 3 Weight	153 kg

Contractual warranty

Warranty	18 months
-----------------	-----------

Sustainability

Green Premium™ label is Schneider Electric's commitment to delivering products with best-in-class environmental performance. Green Premium promises compliance with the latest regulations, transparency on environmental impacts, as well as circular and low-CO₂ products.

Guide to assessing product sustainability is a white paper that clarifies global eco-label standards and how to interpret environmental declarations.

[Learn more about Green Premium >](#)

[Guide to assess a product's sustainability >](#)



RoHS/REACH

Well-being performance

✓ Mercury Free

✓ Rohs Exemption Information [Yes](#)

Certifications & Standards

Reach Regulation [REACH Declaration](#)

Eu Rohs Directive Pro-active compliance (Product out of EU RoHS legal scope)

California Proposition 65
WARNING: This product can expose you to chemicals including: Diisononyl phthalate (DINP), which is known to the State of California to cause cancer, and Diisodecyl phthalate (DIDP), which is known to the State of California to cause birth defects or other reproductive harm. For more information go to www.P65Warnings.ca.gov

Dimensions Drawings

Dimensions

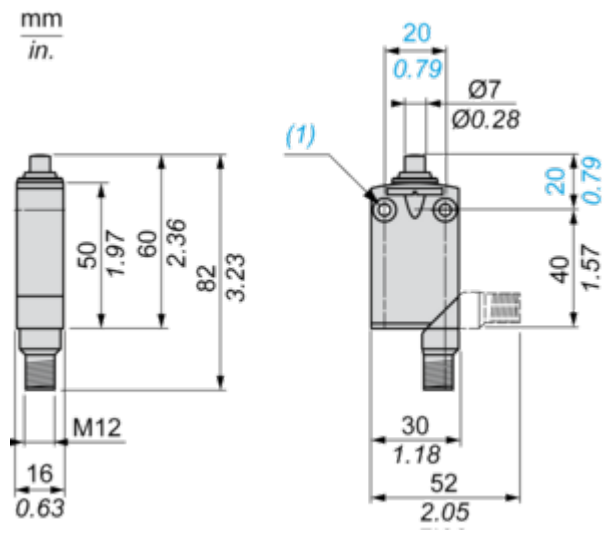

(1) 2 fixing holes Ø 4.2 mm, counterbored Ø 8 mm by 4 mm deep.

Mounting and Clearance

Setting-up

Plunger or Multi-directional Heads

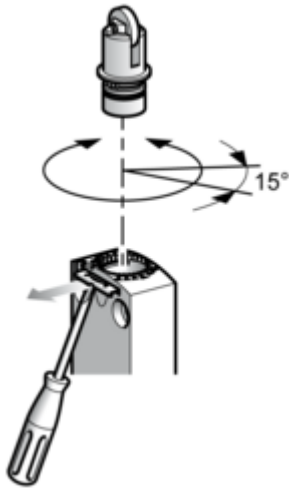

Connections and Schema

Wiring Diagram

Single-pole CO Snap Action + Integral M12 4-pin Connector

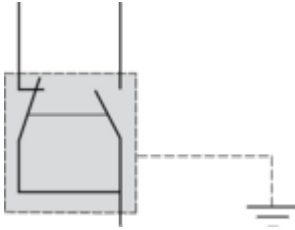

Wiring Diagram

4-pin, M12, 3A-250V

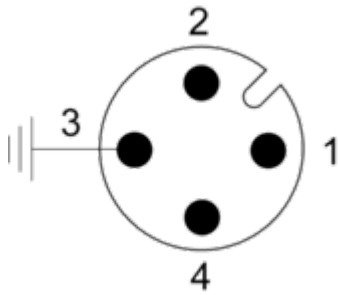

- 1 : Common
- 2 : NC
- 3 : Grounding
- 4 : NO

Technical Description

Characteristics of Actuation

Switch Actuation on End

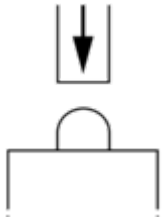

Functional Diagram

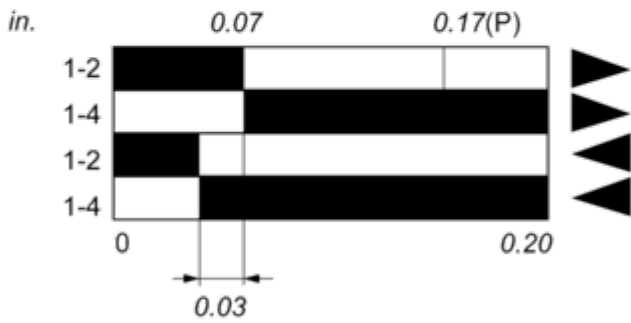
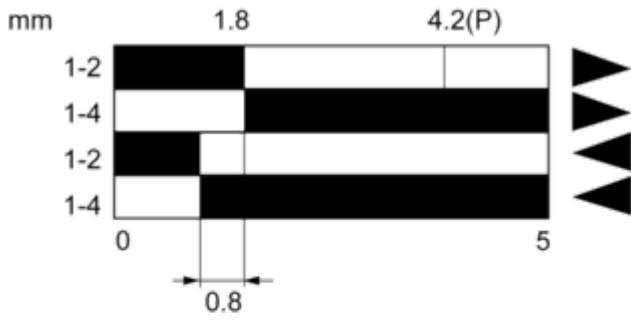

- (1)
- (2)
- ▶ (3)
- ◀ (4)

- (P) Positive opening point
- (1) Closed
- (2) Open
- (4) Tripping
- (5) Resetting