

## Diffuse Narrow Beam LED Collimator Lens - Part No. 185

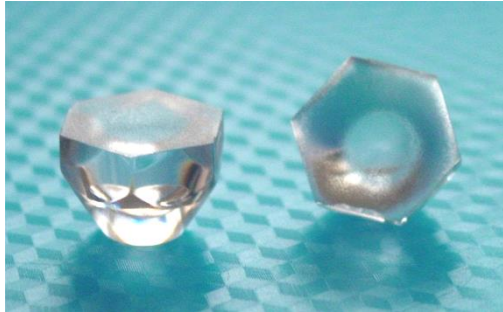

- Designed for High Power Lambertian LED sources
  - High light collection efficiency of >85%
  - Diffuse output surface to give smoother beam
  - Precision moulded in optical grade Polycarbonate for thermal stability and system durability
  - Part of the Polymer Optics “Modular LED Optics”® range
  - Polymer Optics “Modular LED Optics”® design, based on a hexagonal format, allows maximum packing density and assembly flexibility
- POL optics are supplied pre-assembled into the appropriate holder to suit your chosen LED package and are ordered by part number 185/xxx, where xxx is the required holder part number.

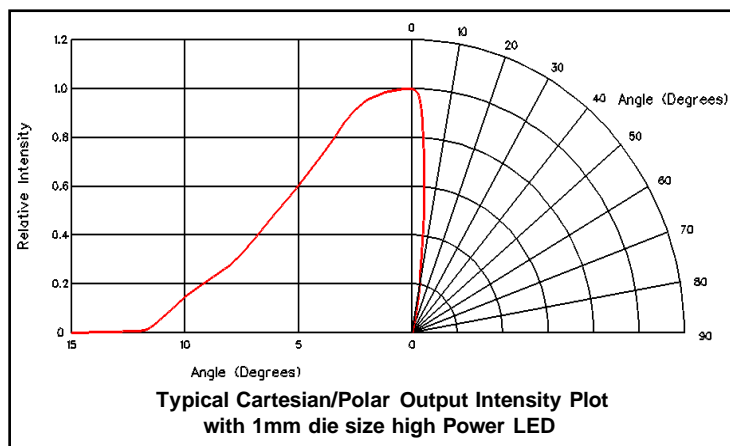

Typical peak illuminance with a 1mm die size Lambertian high power LED = 12cd/lumen

In order to determine if the particular beam properties and performance of this optic are suitable for your application with your chosen LED type, POL suggests that you obtain samples from POL or their distributors for your own product testing, as properties may vary with different LED types.

Due to continuous product improvement, POL reserve the right to change specifications without notice.

© Copyright Polymer Optics Limited 2016

## Diffuse Narrow Beam LED Collimator Lens - Part No. 185

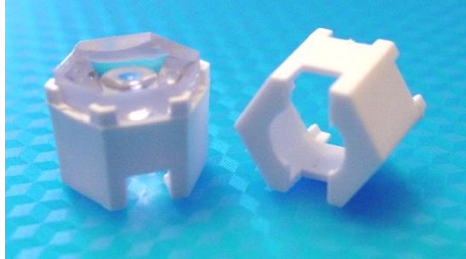

- The details of the holder design will vary for each LED type to provide the correct location to the LED package and mounting height

Typical dimensional tolerances to  
+/-0.2mm

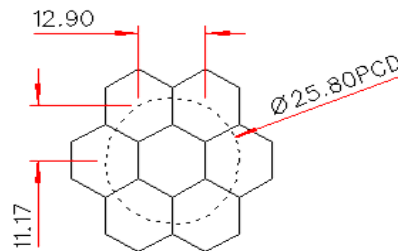
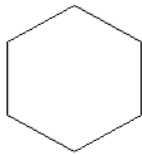

NESTED COMPONENTS ON 25,8MM PCD

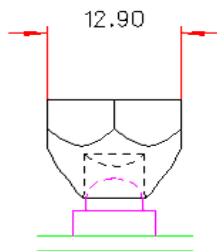

### Mounting Heights in Holder:

121 - 13.7mm
127 - 12.3mm
128 - 12.3mm
147 - 12.3mm
151 - 13.7mm
155 - 13.7mm
175 - 11.4mm
180 - 11.4mm
182 - 11.4mm
223 - 11.4mm
239 - 13.7mm

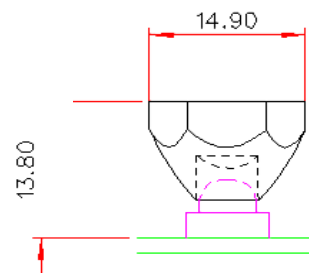

Due to continuous product improvement, POL reserve the right to change specifications without notice.

© Copyright Polymer Optics Limited 2016

## Lens Holder - Part No. 223



- Designed to fit 3.5 x 3.5mm (3535) LED packages or devices with similar overall dimensions
  - Simply mounts onto PCB over the LED and self-aligns to the LED package
  - Precision moulded in high quality Polycarbonate for thermal stability and system durability
  - Part of the Polymer Optics “Modular LED Optics”® range
  - Polymer Optics “Modular LED Optics”® design, based on a hexagonal format, allows maximum packing density and assembly flexibility
- 
- POL optics are supplied pre-assembled into the appropriate holder to suit your chosen LED package and are ordered by part number xxx/223, where xxx is the required optic part number.
  - Please see POL’s on-line product catalogue to determine the correct holder and optic combination for your particular LED type

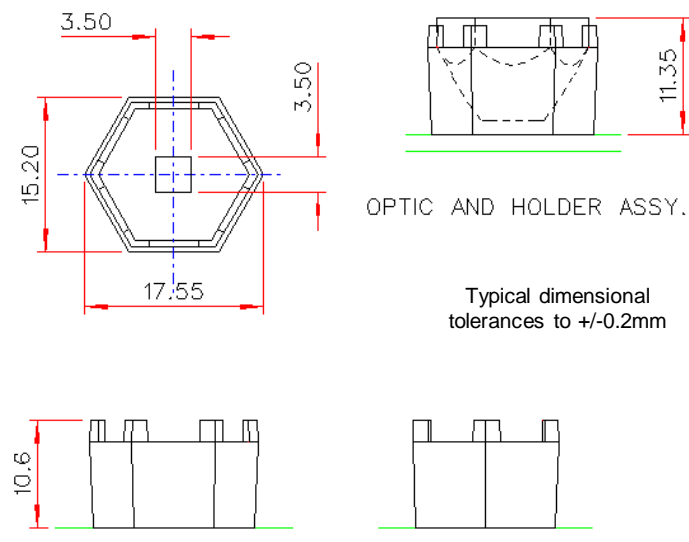

The POL optics assembly can be attached to the PCB with a range of adhesives including epoxies, silicone based flexible adhesives, special super-glues, etc. The final choice of the adhesive will depend on the product application working environment. However, for most applications, POL recommends using Loctite 460 which is a cyano-acrylate “super glue” type adhesive, but a specially formulated low odour, low bloom adhesive for clear plastics. This adhesive will not produce the white cloudiness which occurs with other “super-glue” types and forms a strong bond in seconds between the optics holder and the PCB. Further information on this, and other adhesives, can be found at [www.loctite.co.uk](http://www.loctite.co.uk)

Due to continuous product improvement, POL reserve the right to change specifications without notice.

© Copyright Polymer Optics Limited 2016