

STRADELLA-IP-28-T2-PC

IESNA Type II (medium) beam, applicable for European P-class standard pedestrian lighting and M-class roads. Variant made from PC.

SPECIFICATION:

Dimensions	100.0 x 100.0
Height	9.2 mm
Fastening	screw
Ingress protection classes	IP66,IP67
ROHS compliant	yes ⓘ

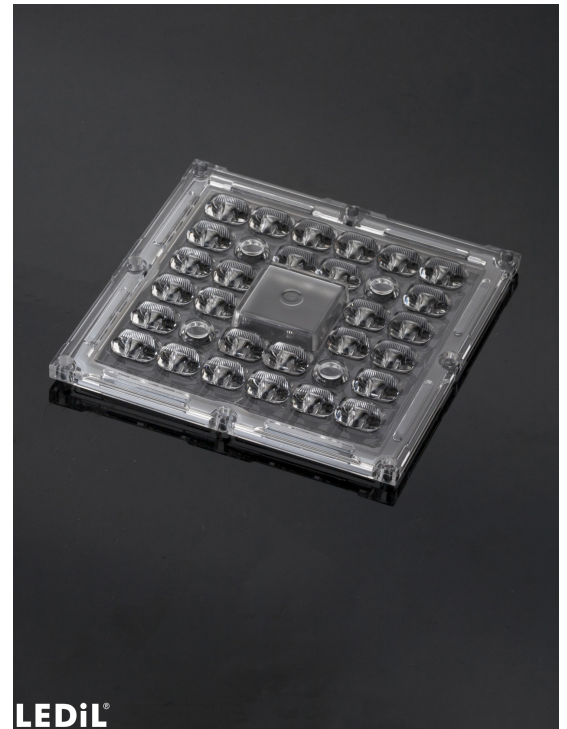

MATERIALS:

Component	Type	Material	Colour	Finish	Length
STRADELLA-IP-28-T2-PC	Multi-lens	PC	clear		100.0
STRADELLA-28-SEAL	Seal	Silicone	white		95.0

ORDERING INFORMATION:

Component		Qty in box	MOQ	MPQ	Box weight (kg)
CS15911_STRADELLA-IP-28-T2-PC	Multi-lens	156	78	78	6.1
» Box size: 476 x 273 x 247 mm					

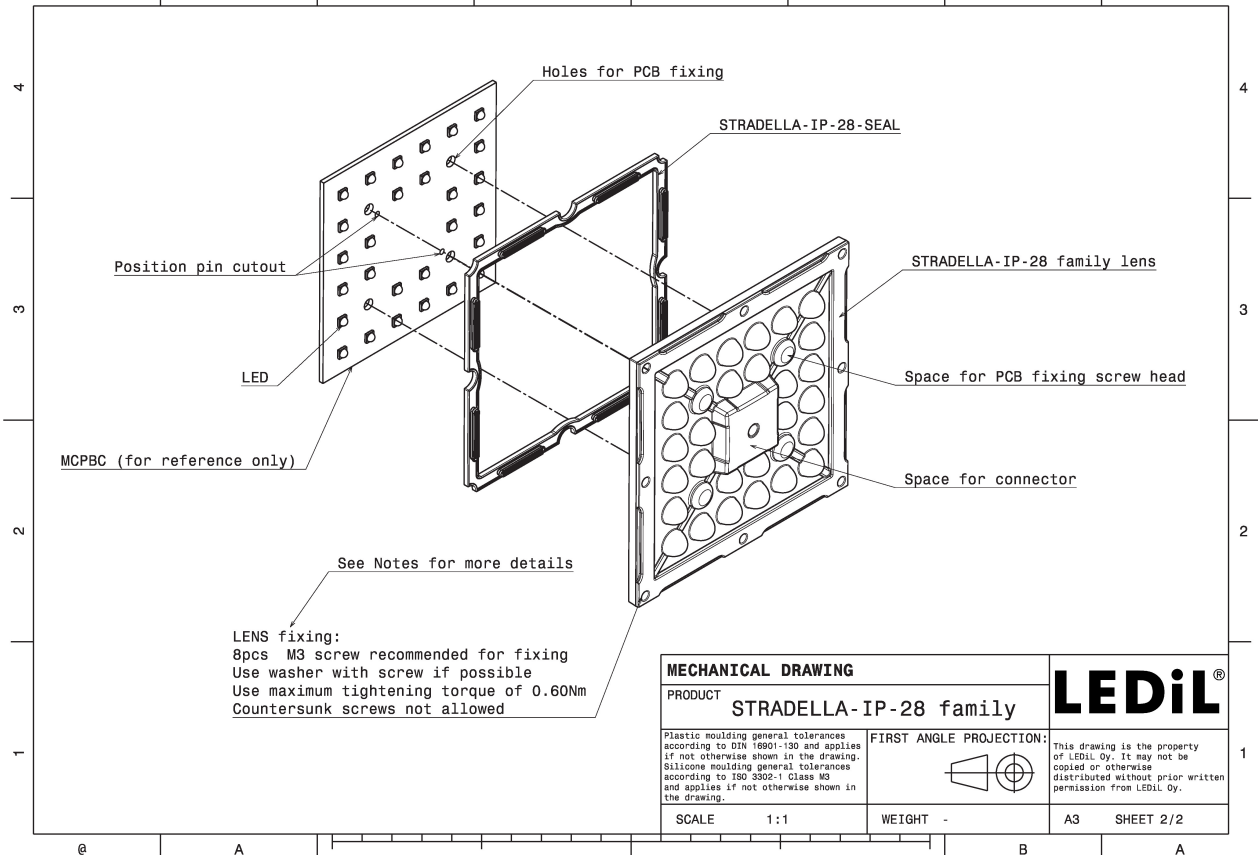
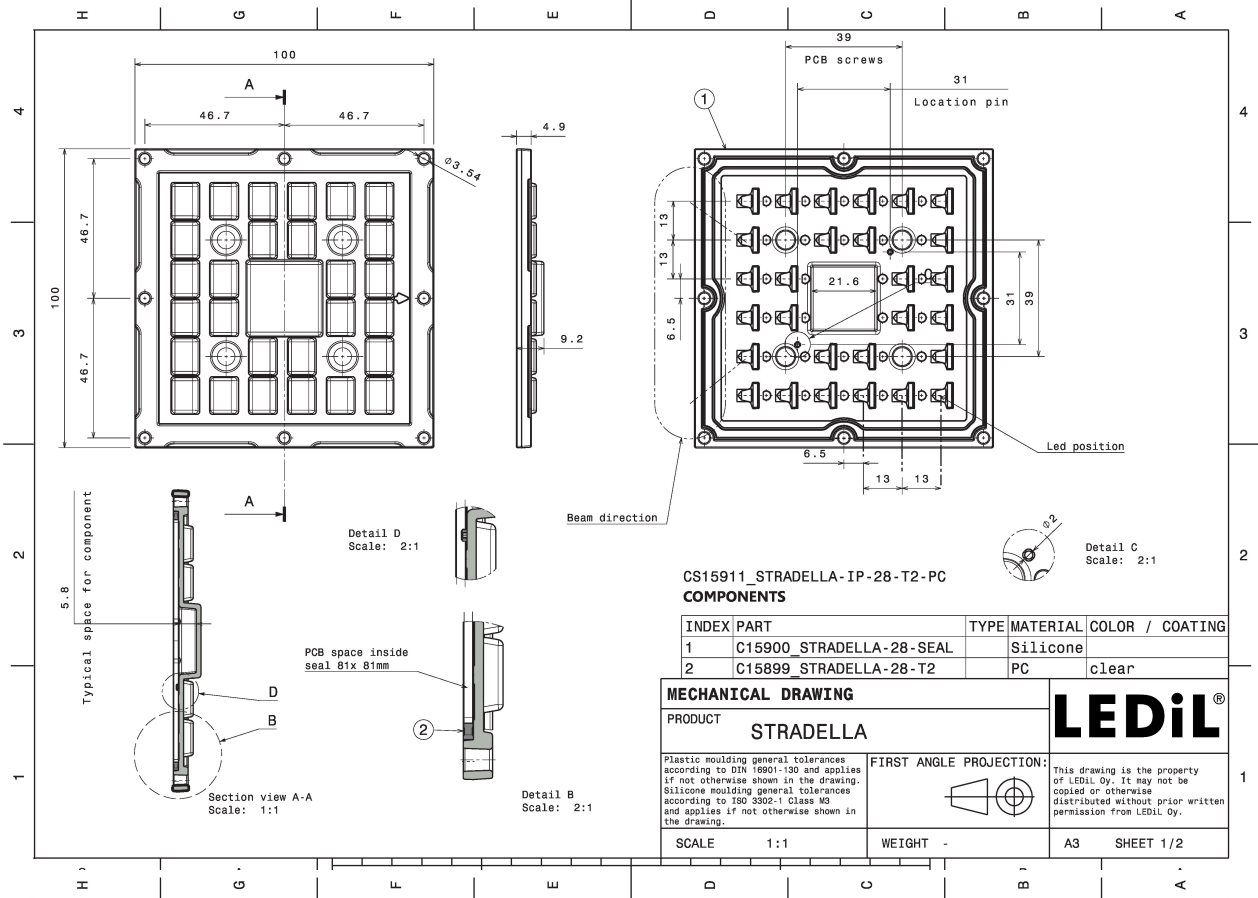

See also our general installation guide: www.ledil.com/installation_guide

OPTICAL RESULTS (MEASURED):



LED HiQLED STR28 CR JE2835 4x7 xxx
FWHM / FWTM Asymmetric
Efficiency 90 %
Peak intensity 1 cd/m
LEDs/each optic 1
Light colour/type White
Required components:

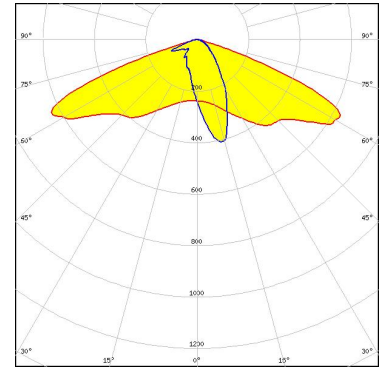

Light distribution files



LED HiQLED STR28 CR JK3030 4x7 xxx
FWHM / FWTM Asymmetric
Efficiency 90 %
Peak intensity 1.1 cd/m
LEDs/each optic 1
Light colour/type White
Required components:

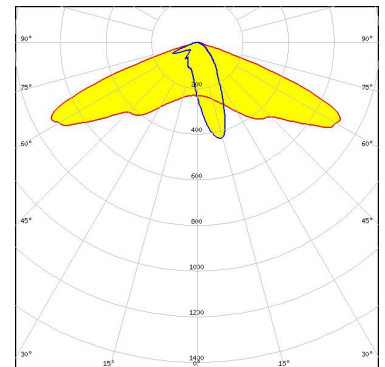

Light distribution files



LED QUICK FLUX STR28 XD2x14 xxx G8
FWHM / FWTM Asymmetric
Efficiency 90 %
Peak intensity 0.9 cd/m
LEDs/each optic 1
Light colour/type White
Required components:

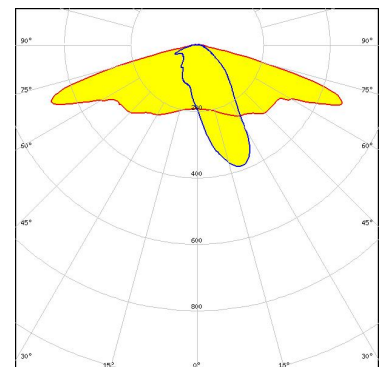

Light distribution files

OPTICAL RESULTS (MEASURED):



LED QUICK FLUX STR28 XP2x14 xxx G7
FWHM / FWTM Asymmetric
Efficiency 91 %
Peak intensity 0.6 cd/lm
LEDs/each optic 1
Light colour/type White
Required components:

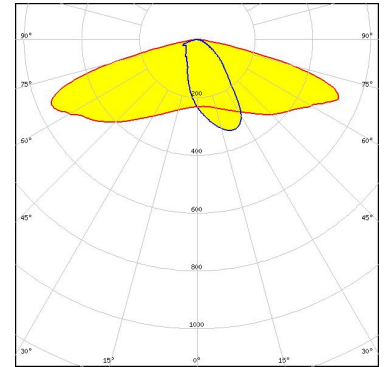

Light distribution files



LED QUICK FLUX STR28 XT2x14 xxx G5
FWHM / FWTM Asymmetric
Efficiency 91 %
Peak intensity 0.6 cd/lm
LEDs/each optic 1
Light colour/type White
Required components:

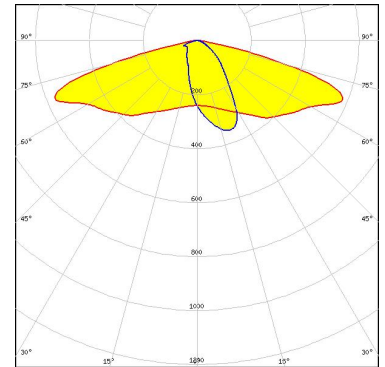

Light distribution files



LED J Series 2835
FWHM / FWTM Asymmetric
Efficiency 90 %
Peak intensity 1 cd/lm
LEDs/each optic 1
Light colour/type White
Required components:

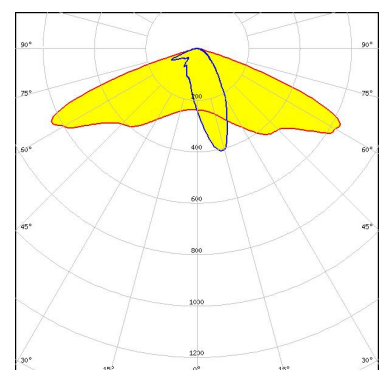

Light distribution files

OPTICAL RESULTS (MEASURED):



LED J Series 3030
FWHM / FWTM Asymmetric
Efficiency 93 %
Peak intensity 0.8 cd/lm
LEDs/each optic 1
Light colour/type White
Required components:

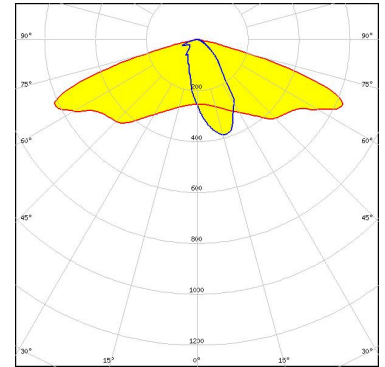

Light distribution files



LED J Series 3030
FWHM / FWTM Asymmetric
Efficiency 90 %
Peak intensity 1.1 cd/lm
LEDs/each optic 1
Light colour/type White
Required components:

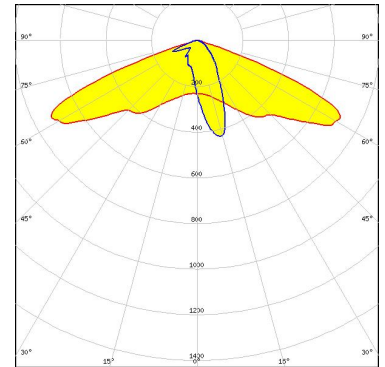

Light distribution files



LED XD16
FWHM / FWTM Asymmetric
Efficiency 90 %
Peak intensity 0.9 cd/lm
LEDs/each optic 1
Light colour/type White
Required components:

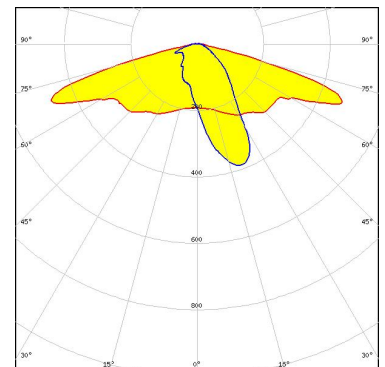

Light distribution files

OPTICAL RESULTS (MEASURED):



LED XP-G3
 FWHM / FWTM Asymmetric
 Efficiency 91 %
 Peak intensity 0.6 cd/lm
 LEDs/each optic 1
 Light colour/type White
 Required components:

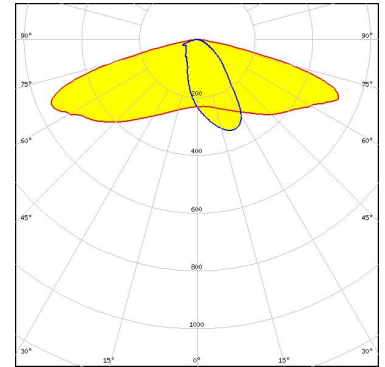

Light distribution files



LED XT-E
 FWHM / FWTM Asymmetric
 Efficiency 91 %
 Peak intensity 0.6 cd/lm
 LEDs/each optic 1
 Light colour/type White
 Required components:

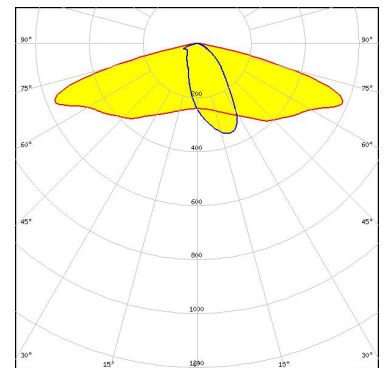

Light distribution files



LED LUXEON 3030 2D (Round LES)
 FWHM / FWTM Asymmetric
 Efficiency 91 %
 Peak intensity 0.9 cd/lm
 LEDs/each optic 1
 Light colour/type White
 Required components:

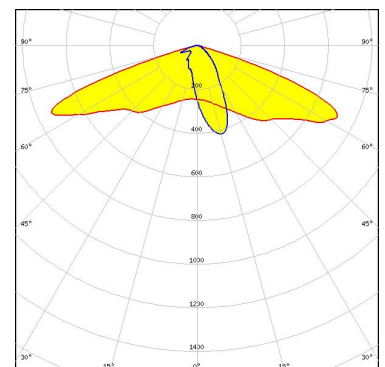

Light distribution files

OPTICAL RESULTS (MEASURED):



LED NF2x757G
 FWHM / FWTM Asymmetric
 Efficiency 91 %
 Peak intensity 0.7 cd/lm
 LEDs/each optic 1
 Light colour/type White
 Required components:

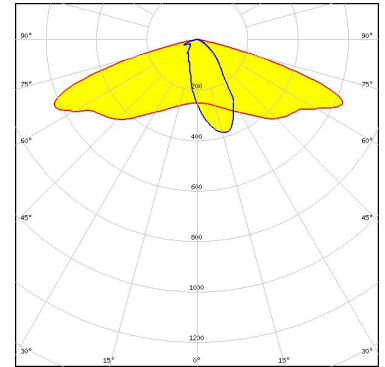

Light distribution files



LED Duris S5 (2 chip)
 FWHM / FWTM Asymmetric
 Efficiency 92 %
 Peak intensity 0.8 cd/lm
 LEDs/each optic 1
 Light colour/type White
 Required components:

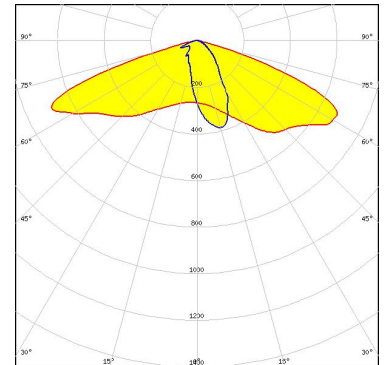

Light distribution files



LED OSCONIQ S 3030 (QSLR31)
 FWHM / FWTM Asymmetric
 Efficiency 92 %
 Peak intensity 0.7 cd/lm
 LEDs/each optic 1
 Light colour/type White
 Required components:

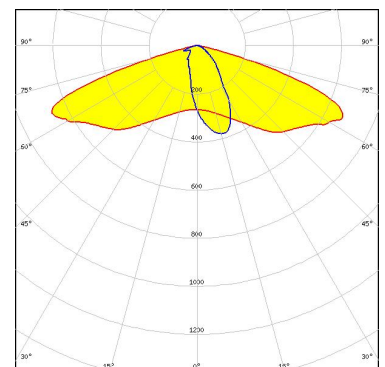

Light distribution files

OPTICAL RESULTS (MEASURED):

OSRAM
Opto Semiconductors

LED OSLON Square CSSRM2/CSSRM3
FWHM / FWTM Asymmetric
Efficiency 92 %
Peak intensity 0.8 cd/lm
LEDs/each optic 1
Light colour/type White
Required components:

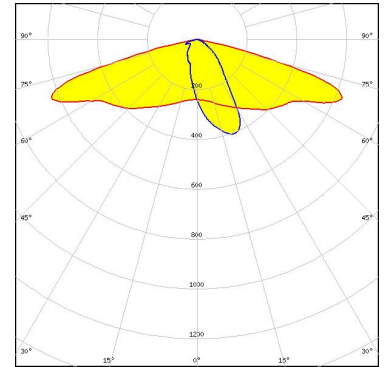

Light distribution files

SAMSUNG

LED HiLOM SC28 (LH181B)
FWHM / FWTM Asymmetric
Efficiency 89 %
Peak intensity 0.9 cd/lm
LEDs/each optic 1
Light colour/type White
Required components:

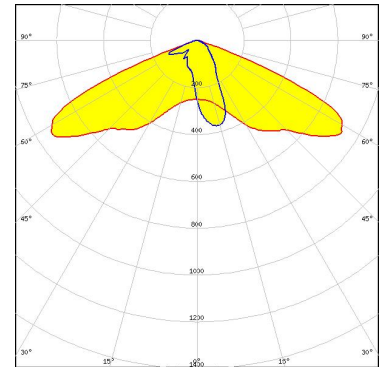

Light distribution files

SAMSUNG

LED HiLOM SM28 (LM301B)
FWHM / FWTM Asymmetric
Efficiency 90 %
Peak intensity 0.9 cd/lm
LEDs/each optic 1
Light colour/type White
Required components:

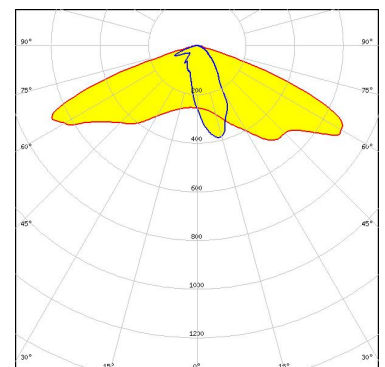

Light distribution files

OPTICAL RESULTS (SIMULATED):



LED LUXEON HL2X
FWHM / FWTM Asymmetric
Efficiency 89 %
Peak intensity 0.5 cd/lm
LEDs/each optic 1
Light colour/type White
Required components:

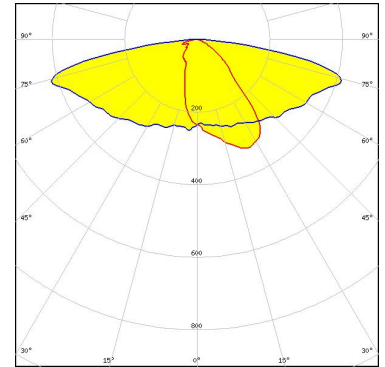

Light distribution files



LED NF2x757G
FWHM / FWTM Asymmetric
Efficiency 91 %
Peak intensity 0.7 cd/lm
LEDs/each optic 1
Light colour/type White
Required components:

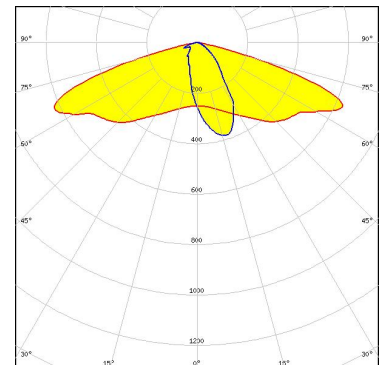

Light distribution files



LED NVSW219F
FWHM / FWTM Asymmetric
Efficiency 86 %
Peak intensity 0.5 cd/lm
LEDs/each optic 1
Light colour/type White
Required components:

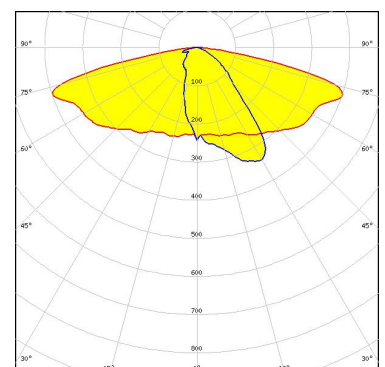

OPTICAL RESULTS (SIMULATED):

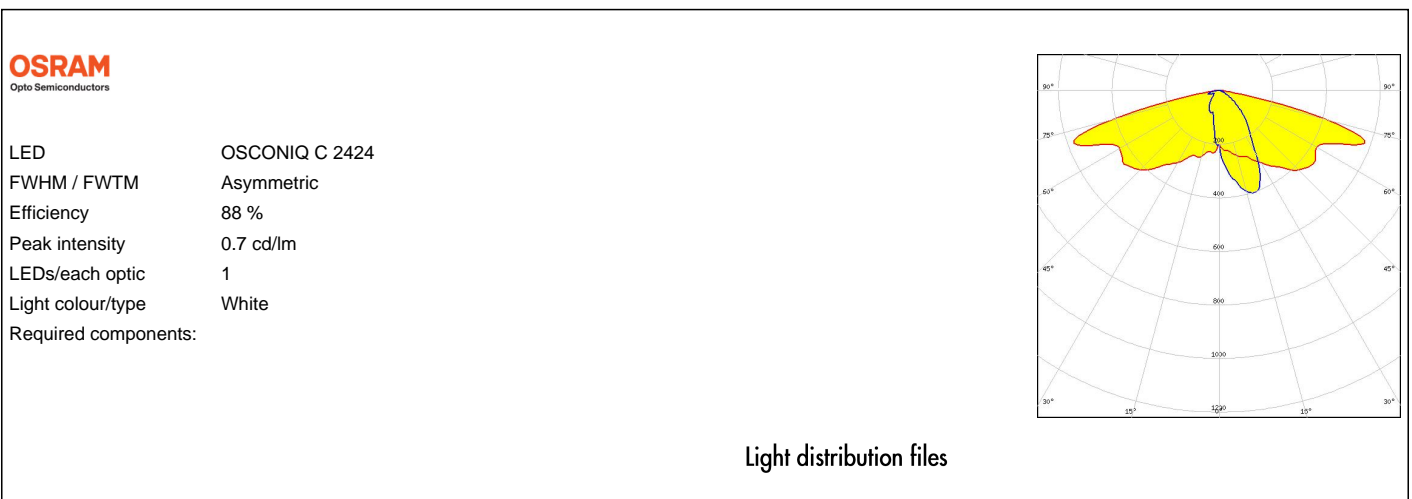
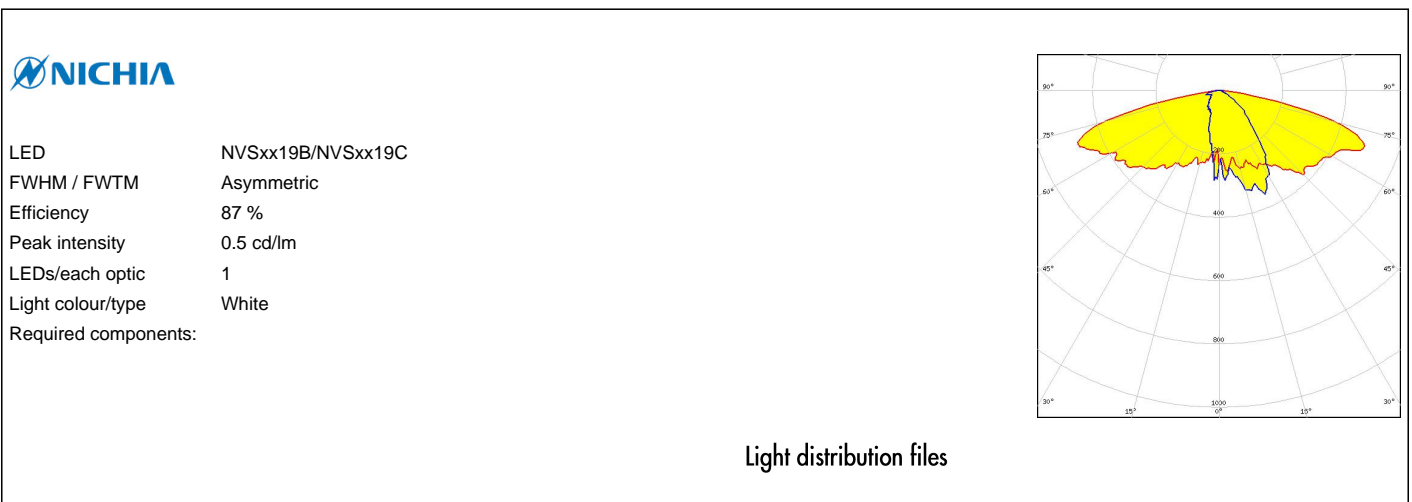
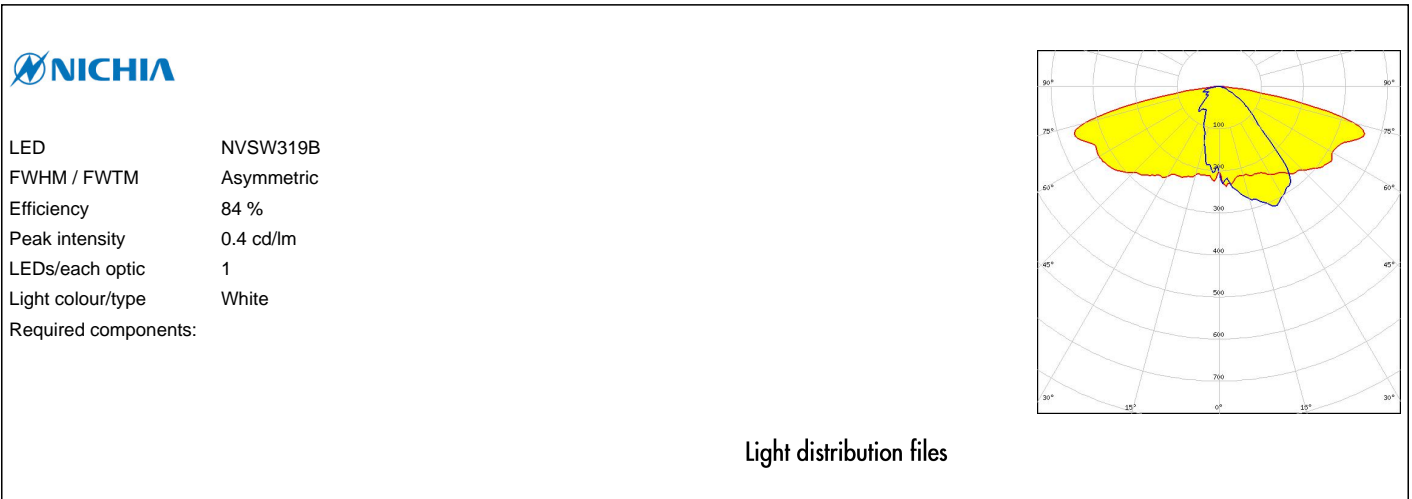

OPTICAL RESULTS (SIMULATED):

OSRAM
Opto Semiconductors

LED OSCONIQ P 3030
 FWHM / FWTM Asymmetric
 Efficiency 94 %
 Peak intensity 0.7 cd/lm
 LEDs/each optic 1
 Light colour/type White
 Required components:

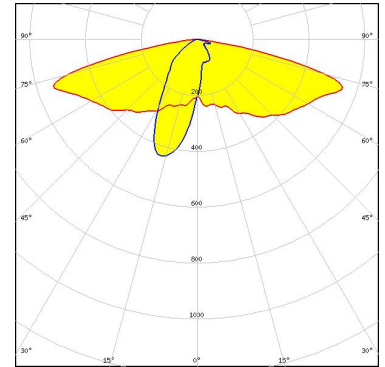

Light distribution files

OSRAM
Opto Semiconductors

LED OSLON Square CSSRM2/CSSRM3
 FWHM / FWTM Asymmetric
 Efficiency 93 %
 Peak intensity 0.6 cd/lm
 LEDs/each optic 1
 Light colour/type White
 Required components:

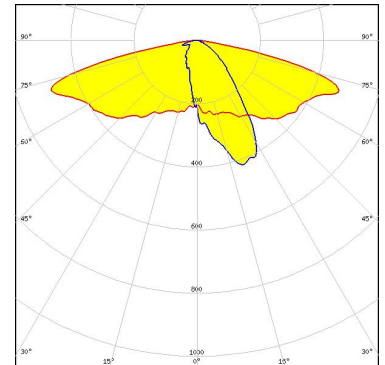

Light distribution files

SAMSUNG

LED LH231B
 FWHM / FWTM Asymmetric
 Efficiency 88 %
 Peak intensity 0.6 cd/lm
 LEDs/each optic 1
 Light colour/type White
 Required components:

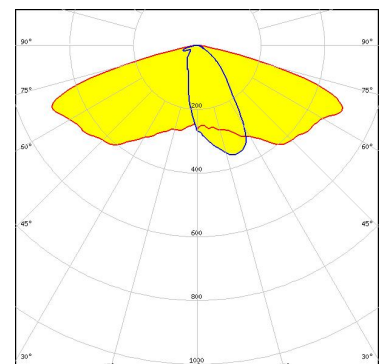

Light distribution files

OPTICAL RESULTS (SIMULATED):

SAMSUNG

LED LH351B
FWHM / FWTM Asymmetric
Efficiency 92 %
Peak intensity 0.5 cd/lm
LEDs/each optic 1
Light colour/type White
Required components:

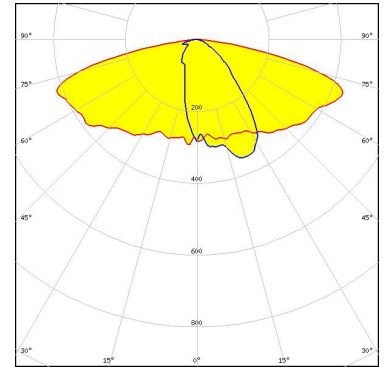

Light distribution files



LED SEOUL DC 3030
FWHM / FWTM Asymmetric
Efficiency 90 %
Peak intensity 0.6 cd/lm
LEDs/each optic 1
Light colour/type White
Required components:



LED Z5M1/Z5M2
FWHM / FWTM Asymmetric
Efficiency 89 %
Peak intensity 0.6 cd/lm
LEDs/each optic 1
Light colour/type White
Required components:

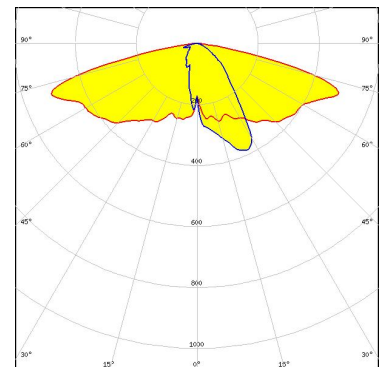

Light distribution files

OPTICAL RESULTS (SIMULATED):

SEOL SEMICONDUCTOR

LED	Z8Y19
FWHM / FWTM	Asymmetric
Efficiency	85 %
Peak intensity	0.7 cd/lm
LEDs/each optic	1
Light colour/type	White
Required components:	

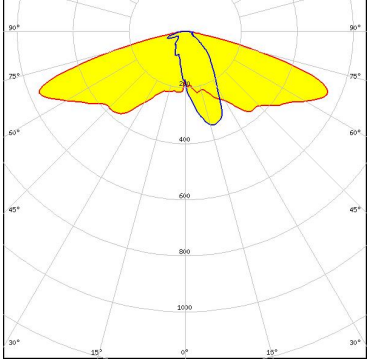

Light distribution files

SEOL SEMICONDUCTOR

LED	Z8Y22
FWHM / FWTM	Asymmetric
Efficiency	85 %
Peak intensity	0.6 cd/lm
LEDs/each optic	1
Light colour/type	White
Required components:	

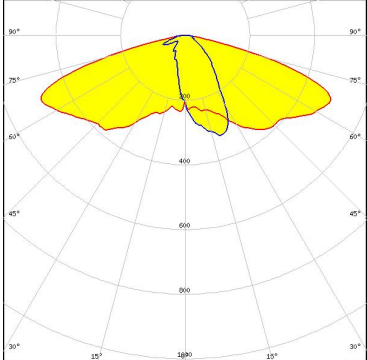

Light distribution files

GENERAL INFORMATION:

NOTE: The typical beam angle will be changed by different color, chip size and chip position tolerance. The typical total beam angle is the full angle measured where the luminous intensity is half of the peak value.

MATERIALS:

As part of our continuous research and improvement processes, and to ensure the best possible quality and availability of our products, LEDiL reserves the right to change material grades without notice.

PRODUCT DATA USER AGREEMENT AND DISCLAIMER:

The measured data in the provided downloadable LEDiL Product Datasheets and Mechanical 2D-Drawings is rounded and provided as reference for planning. LEDiL Oy's optical specifications have been verified by conducting performance testing of the products in accordance with the company's quality system. The reported data are averaged results of multiple measurements with typical variation. LEDiL Oy reserves the right to without prior notification make changes and improvements to its products.

LEDiL Oy assumes neither warranty, nor guarantee nor any other liability of any kind for the contents and correctness of the provided data. The provided data has been generated with highest diligence but the provided data may in reality not represent the complete possible variation range of all intrinsic parameters. Therefore, in certain cases a deviation from the provided data could occur.

LEDiL Oy reserves the right to undertake technical changes of its products without further notification which could lead to changes in the provided data. LEDiL Oy assumes no liability of any kind for the possible deviation from any provided data or any other damage resulting from the usage of the provided data.

The user agrees to this disclaimer and user agreement with the download or usage of the provided files.

LEDiL Oy

Joensuunkatu 13
FI-24240 SALO
Finland

LEDiL Inc.

228 West Page Street
Suite D
Sycamore IL 60178
USA

Ledil Optics Technology (Shenzhen) Co., Ltd.

405 , Block B
Casic Motor Building
Shenzhen 518057
P.R.CHINA

Local sales and technical support

[www.ledil.com/
where_to_buy](http://www.ledil.com/where_to_buy)

Shipping locations

Poznan, Poland
Hong Kong, China

Distribution Partners

[www.ledil.com/
where_to_buy](http://www.ledil.com/where_to_buy)