

YASMEEN-30-RS

~11° spot beam. Variant with holder.

SPECIFICATION:

Dimensions	Ø 32.0 mm
Height	18.9 mm
Fastening	tape, pin
ROHS compliant	yes ⓘ

MATERIALS:

Component	Type	Material	Colour	Finish	Length
YASMEEN-30-RS	Single lens	PMMA	clear		29.7
OLGA-HLD	Holder	PC	black		32.0
SPUTNIK-TAPE3	Tape	Acrylic foam	black		25.0



ORDERING INFORMATION:

Component	Qty in box	MOQ	MPQ	Box weight (kg)
CA17181_YASMEEN-30-RS » Box size: 480 x 280 x 300 mm	792	132	66	7.7

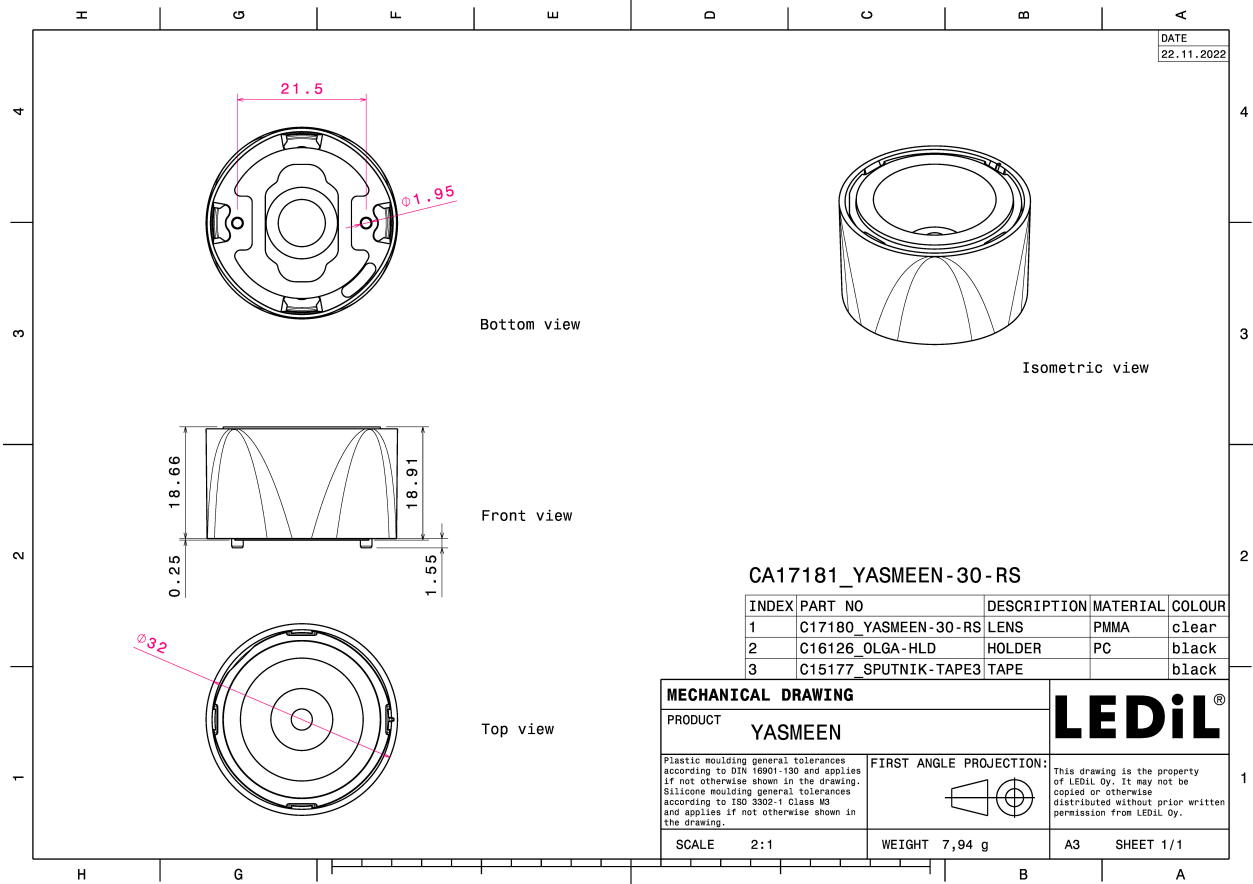

See also our general installation guide: www.ledil.com/installation_guide

OPTICAL RESULTS (MEASURED):



LED XHP35 HI
FWHM / FWTM 12.0° / 23.0°
Efficiency 88 %
Peak intensity 14.4 cd/lm
LEDs/each optic 1
Light colour/type White
Required components:

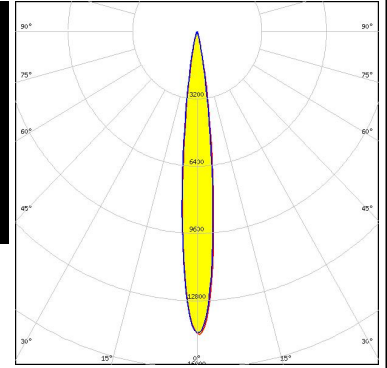
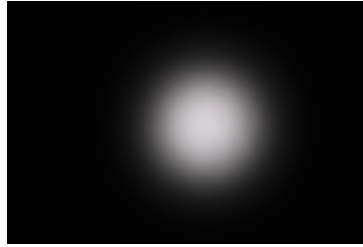

Light distribution files

OPTICAL RESULTS (SIMULATED):



LED XHP35 HI
FWHM / FWTM 12.0° / 24.0°
Efficiency 91 %
Peak intensity 14.2 cd/lm
LEDs/each optic 1
Light colour/type White
Required components:

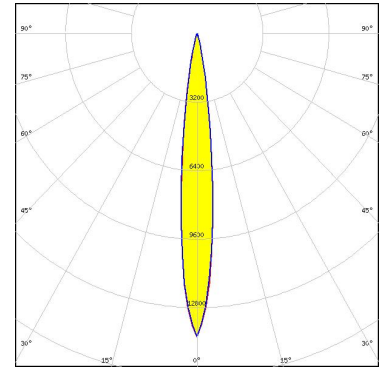

Light distribution files



LED XHP35.2 HD
FWHM / FWTM 18.0° / 33.0°
Efficiency 86 %
Peak intensity 7.4 cd/lm
LEDs/each optic 1
Light colour/type White
Required components:

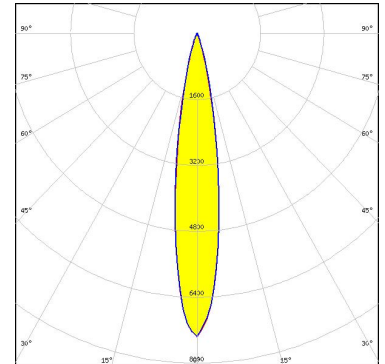

Light distribution files



LED XHP70
FWHM / FWTM 26.0° / 49.0°
Efficiency 86 %
Peak intensity 3.3 cd/lm
LEDs/each optic 1
Light colour/type White
Required components:

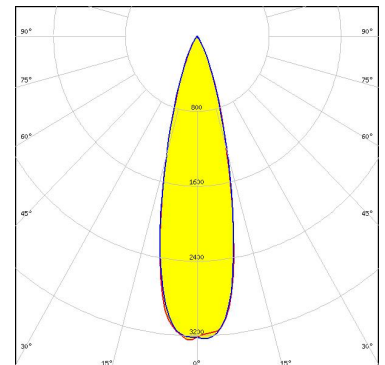

Light distribution files

OPTICAL RESULTS (SIMULATED):



LED XHP70.3 HI
 FWHM / FWTM 18.0° / 38.0°
 Efficiency 87 %
 Peak intensity 6 cd/lm
 LEDs/each optic 1
 Light colour/type White
 Required components:

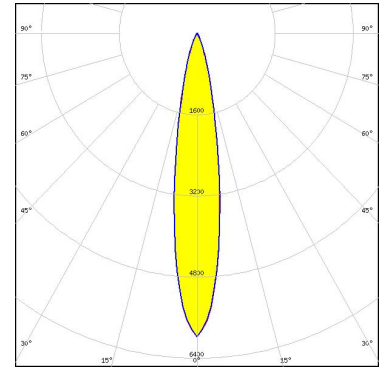

Light distribution files



LED XM-L
 FWHM / FWTM 14.0° / 28.0°
 Efficiency 91 %
 Peak intensity 11.4 cd/lm
 LEDs/each optic 1
 Light colour/type White
 Required components:

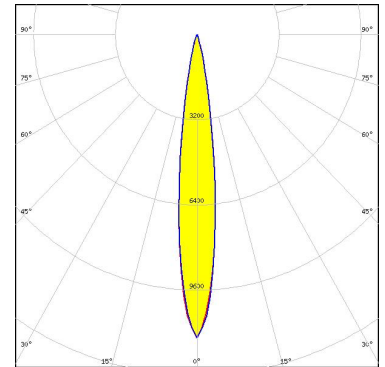

Light distribution files



LED XP-E2
 FWHM / FWTM 12.0° / 22.0°
 Efficiency 92 %
 Peak intensity 18.6 cd/lm
 LEDs/each optic 1
 Light colour/type White
 Required components:

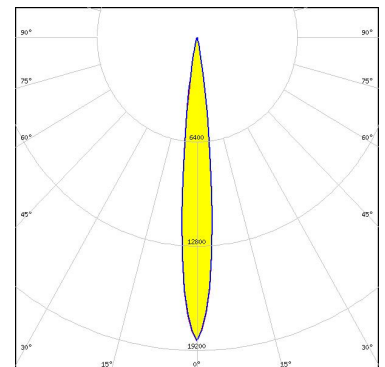

Light distribution files

OPTICAL RESULTS (SIMULATED):



LED XP-G2
FWHM / FWTM 11.4° / 20.8°
Efficiency 92 %
Peak intensity 22.7 cd/lm
LEDs/each optic 1
Light colour/type White
Required components:

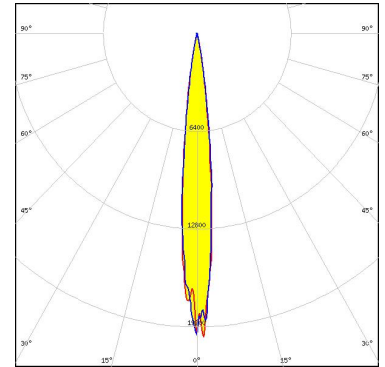

Light distribution files



LED XP-G4 HI
FWHM / FWTM 12.0° / 22.0°
Efficiency 90 %
Peak intensity 17.4 cd/lm
LEDs/each optic 1
Light colour/type White
Required components:

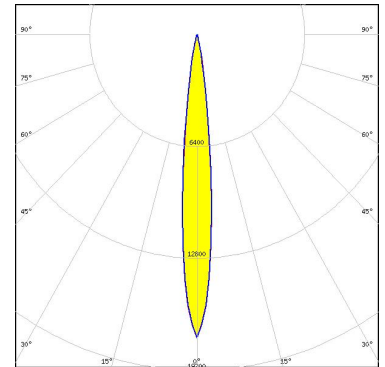

LED XP-P
FWHM / FWTM 10.0° / 20.0°
Efficiency 96 %
Peak intensity 23.4 cd/lm
LEDs/each optic 1
Light colour/type White
Required components:

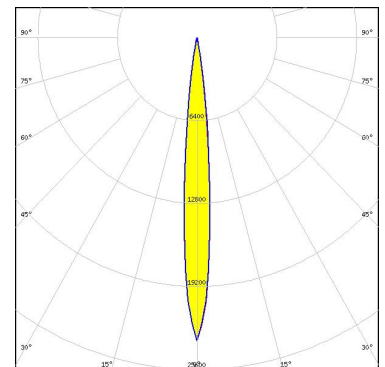

Light distribution files

OPTICAL RESULTS (SIMULATED):



LED LUXEON 7070
 FWHM / FWTM 20.0° / 47.0°
 Efficiency 84 %
 Peak intensity 4 cd/lm
 LEDs/each optic 1
 Light colour/type White
 Required components:

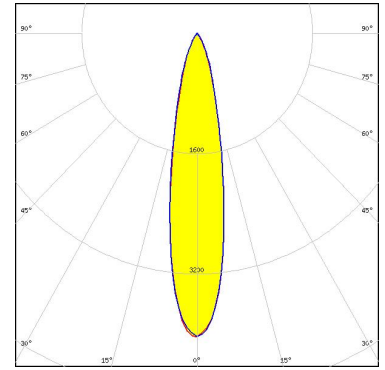

LED LUXEON C
 FWHM / FWTM 12.0° / 22.0°
 Efficiency 86 %
 Peak intensity 15.7 cd/lm
 LEDs/each optic 1
 Light colour/type White
 Required components:

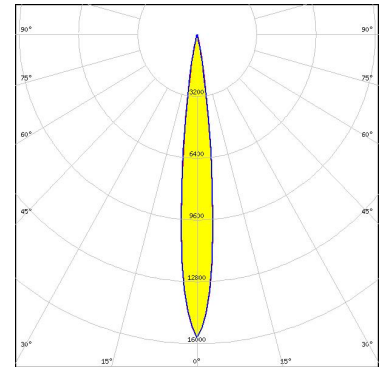

Light distribution files



LED LUXEON CZ
 FWHM / FWTM 11.0° / 20.0°
 Efficiency 92 %
 Peak intensity 19.8 cd/lm
 LEDs/each optic 1
 Light colour/type White
 Required components:

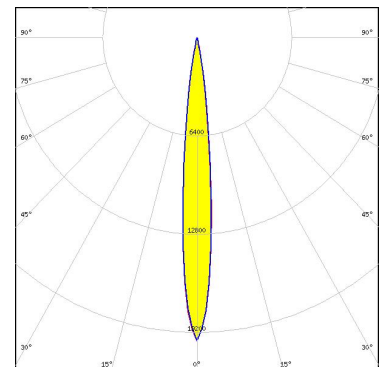

Light distribution files

OPTICAL RESULTS (SIMULATED):



LED NCSxE17A
FWHM / FWTM 10.0° / 24.0°
Efficiency 88 %
Peak intensity 14.5 cd/lm
LEDs/each optic 1
Light colour/type White
Required components:

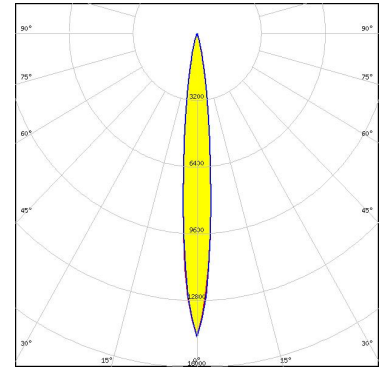

Light distribution files



LED NF2x757G
FWHM / FWTM 12.0° / 26.0°
Efficiency 91 %
Peak intensity 13 cd/lm
LEDs/each optic 1
Light colour/type White
Required components:



LED NV4WB35AM
FWHM / FWTM 14.0° / 30.0°
Efficiency 91 %
Peak intensity 10.1 cd/lm
LEDs/each optic 1
Light colour/type White
Required components:

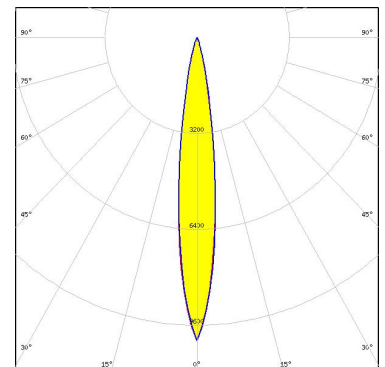

Light distribution files

OPTICAL RESULTS (SIMULATED):



LED NV4WB35AM
FWHM / FWTM 14.0° / 30.0°
Efficiency 91 %
Peak intensity 10.1 cd/lm
LEDs/each optic 1
Light colour/type White
Required components:

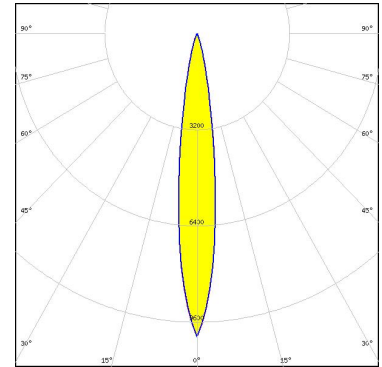

Light distribution files



LED NV4x144A
FWHM / FWTM 20.0° / 38.0°
Efficiency 88 %
Peak intensity 5.8 cd/lm
LEDs/each optic 1
Light colour/type White
Required components:

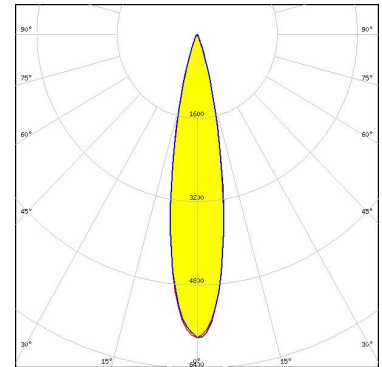

Light distribution files



LED NVSW719AC
FWHM / FWTM 12.0° / 22.0°
Efficiency 92 %
Peak intensity 16.9 cd/lm
LEDs/each optic 1
Light colour/type White
Required components:

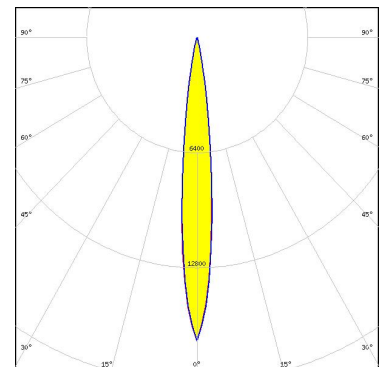

OPTICAL RESULTS (SIMULATED):

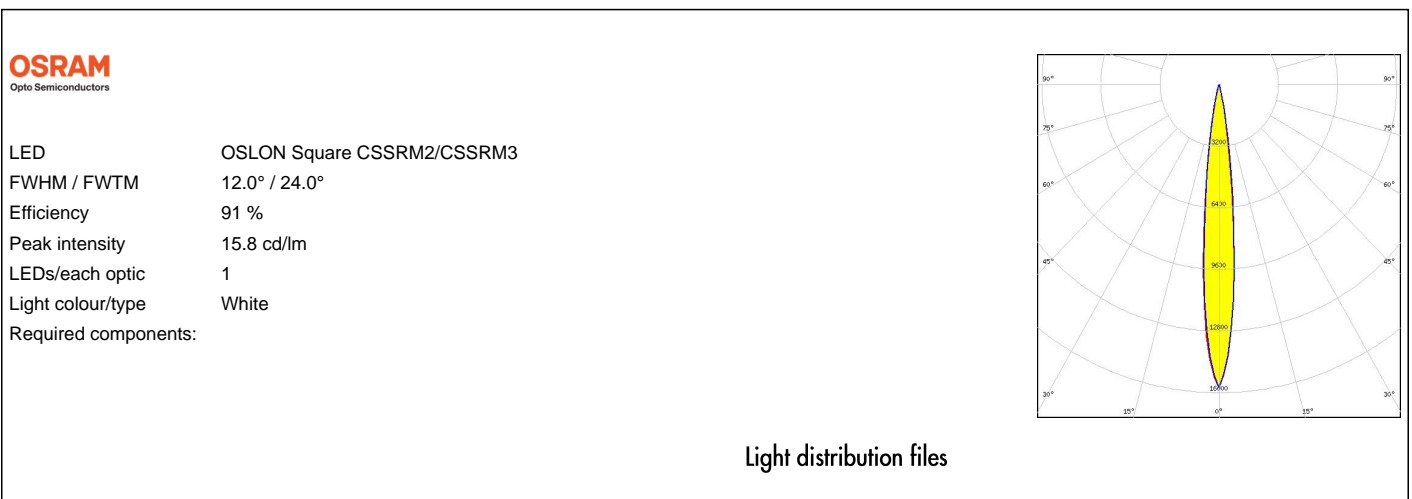
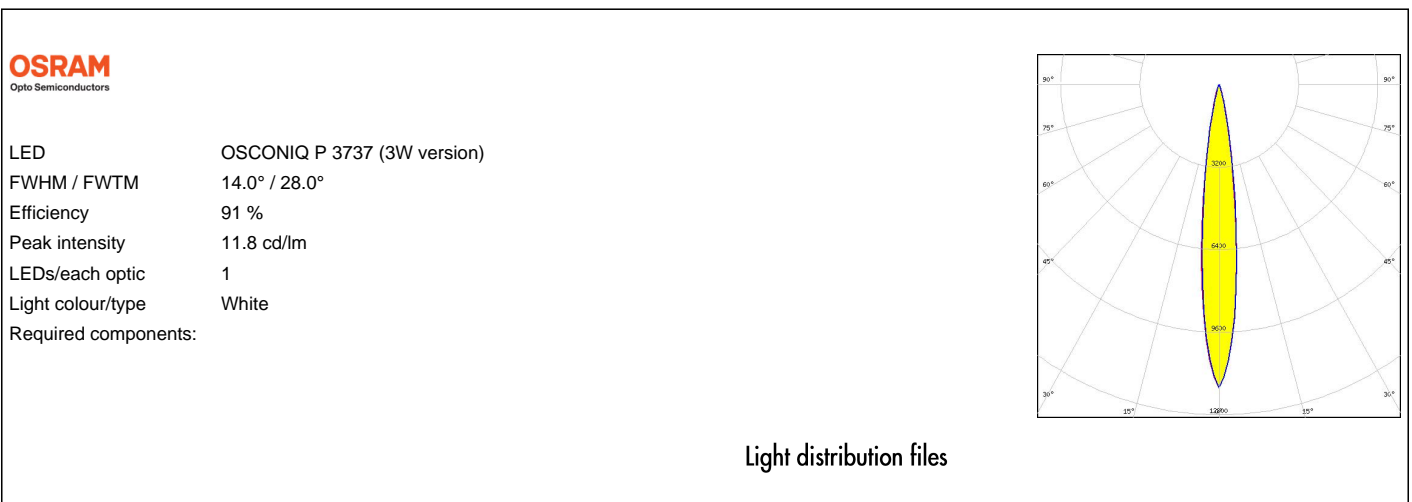

OPTICAL RESULTS (SIMULATED):

SAMSUNG

LED LH151B
FWHM / FWTM 16.0° / 39.0°
Efficiency 88 %
Peak intensity 6.1 cd/lm
LEDs/each optic 4
Light colour/type White
Required components:

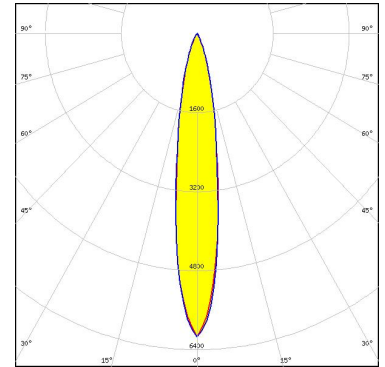

Light distribution files

SAMSUNG

LED LH351C
FWHM / FWTM 10.0° / 20.0°
Efficiency 94 %
Peak intensity 21.7 cd/lm
LEDs/each optic 1
Light colour/type White
Required components:

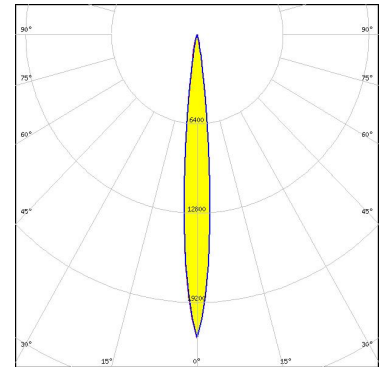

Light distribution files

SAMSUNG

LED LH351D
FWHM / FWTM 12.0° / 24.0°
Efficiency 92 %
Peak intensity 14.2 cd/lm
LEDs/each optic 1
Light colour/type White
Required components:

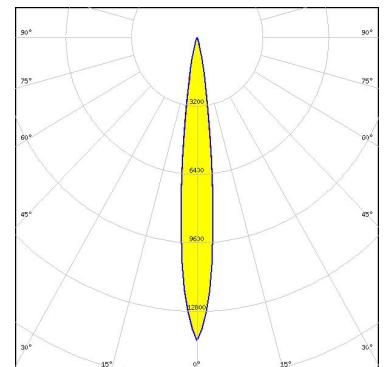

Light distribution files

GENERAL INFORMATION:

NOTE: The typical beam angle will be changed by different color, chip size and chip position tolerance. The typical total beam angle is the full angle measured where the luminous intensity is half of the peak value.

MATERIALS:

As part of our continuous research and improvement processes, and to ensure the best possible quality and availability of our products, LEDiL reserves the right to change material grades without notice.

PRODUCT DATA USER AGREEMENT AND DISCLAIMER:

The measured data in the provided downloadable LEDiL Product Datasheets and Mechanical 2D-Drawings is rounded and provided as reference for planning. LEDiL Oy's optical specifications have been verified by conducting performance testing of the products in accordance with the company's quality system. The reported data are averaged results of multiple measurements with typical variation. LEDiL Oy reserves the right to without prior notification make changes and improvements to its products.

LEDiL Oy assumes neither warranty, nor guarantee nor any other liability of any kind for the contents and correctness of the provided data. The provided data has been generated with highest diligence but the provided data may in reality not represent the complete possible variation range of all intrinsic parameters. Therefore, in certain cases a deviation from the provided data could occur.

LEDiL Oy reserves the right to undertake technical changes of its products without further notification which could lead to changes in the provided data. LEDiL Oy assumes no liability of any kind for the possible deviation from any provided data or any other damage resulting from the usage of the provided data.

The user agrees to this disclaimer and user agreement with the download or usage of the provided files.

LEDiL Oy

Joensuunkatu 13
FI-24240 SALO
Finland

LEDiL Inc.

228 West Page Street
Suite D
Sycamore IL 60178
USA

Ledil Optics Technology (Shenzhen) Co., Ltd.

405 , Block B
Casic Motor Building
Shenzhen 518057
P.R.CHINA

Local sales and technical support

[www.ledil.com/
where_to_buy](http://www.ledil.com/where_to_buy)

Shipping locations

Poznan, Poland
Hong Kong, China

Distribution Partners

[www.ledil.com/
where_to_buy](http://www.ledil.com/where_to_buy)