

Isolated Dual Channel IGBT/MOSFET Gate Driver

NCD57252, NCD57253, NCD57255, NCD57256, NCV57252, NCV57253, NCV57255, NCV57256

NCx5725y are high-current two channel isolated IGBT/MOSFET gate drivers with 2.5 or 5 kV_{rms}* internal galvanic isolation from input to each output and functional isolation between the two output channels. The device accepts 3.3 V to 20 V bias voltage and signal levels on the input side and up to 32 V bias voltage on the output side. The device accepts complementary inputs and offers separate pins for Disable and Dead Time control for system design convenience. Drivers are available in wide body SOIC-16 and narrow body SOIC-16 package.

Features

- High Peak Output Current ($\pm 6.5\text{ A}^*$, $\pm 3.5\text{ A}^*$)
- Configurable as a Dual Low-Side or Dual High-Side or Half-Bridge Driver
- Programmable Overlap or Dead Time control
- Disable Pin to Turn Off Outputs for Power Sequencing
- ANB Function to Offer Flexibility to Set up the Driver as Half-bridge Driver Operating with a Single Input Signal
- IGBT/MOSFET Gate Clamping during Short Circuit
- Short Propagation Delays with Accurate Matching
- Tight UVLO Thresholds on all Power Supplies
- 3.3 V, 5 V, and 15 V Logic Input
- 2.5 or 5 kV_{rms}* Galvanic Isolation from Input to each Output and 1.5 kV_{rms} Differential Voltage between Output Channels
- 1200 V Working Voltage (per VDE0884-11 Requirements)
- High Common Mode Transient Immunity
- NCV Prefix for Automotive and Other Applications Requiring Unique Site and Control Change Requirements; AEC-Q100 Qualified and PPAP Capable
- This Device is Pb-Free, Halogen Free/BFR Free and is RoHS Compliant

Typical Applications

- EV Chargers
- Motor Control
- Uninterruptible Power Supplies (UPS)
- Industrial Power Supplies
- Solar Inverters
- Automotive Applications

*Depends on package variant, see Page 6, 21.

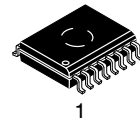

SOIC-16 WB
CASE 751G-03

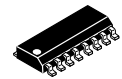

SOIC-16
D SUFFIX
CASE 751B-05

MARKING DIAGRAMS

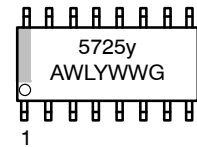
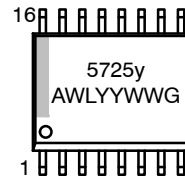

5725y = Specific Device Code
y = 2, 3, 5 or 6
A = Assembly Location
WL = Wafer Lot
YY, Y = Year
WW = Work Week
G = Pb-Free Package
(See page 21)

PIN CONNECTIONS

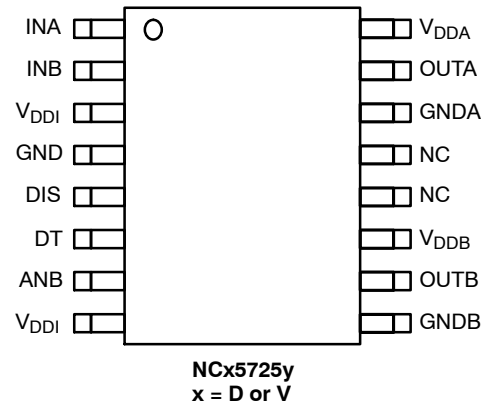

ORDERING INFORMATION

See detailed ordering and shipping information on page 21 of this data sheet.

NCD57252, NCD57253, NCD57255, NCD57256, NCV57252, NCV57253, NCV57255, NCV57256

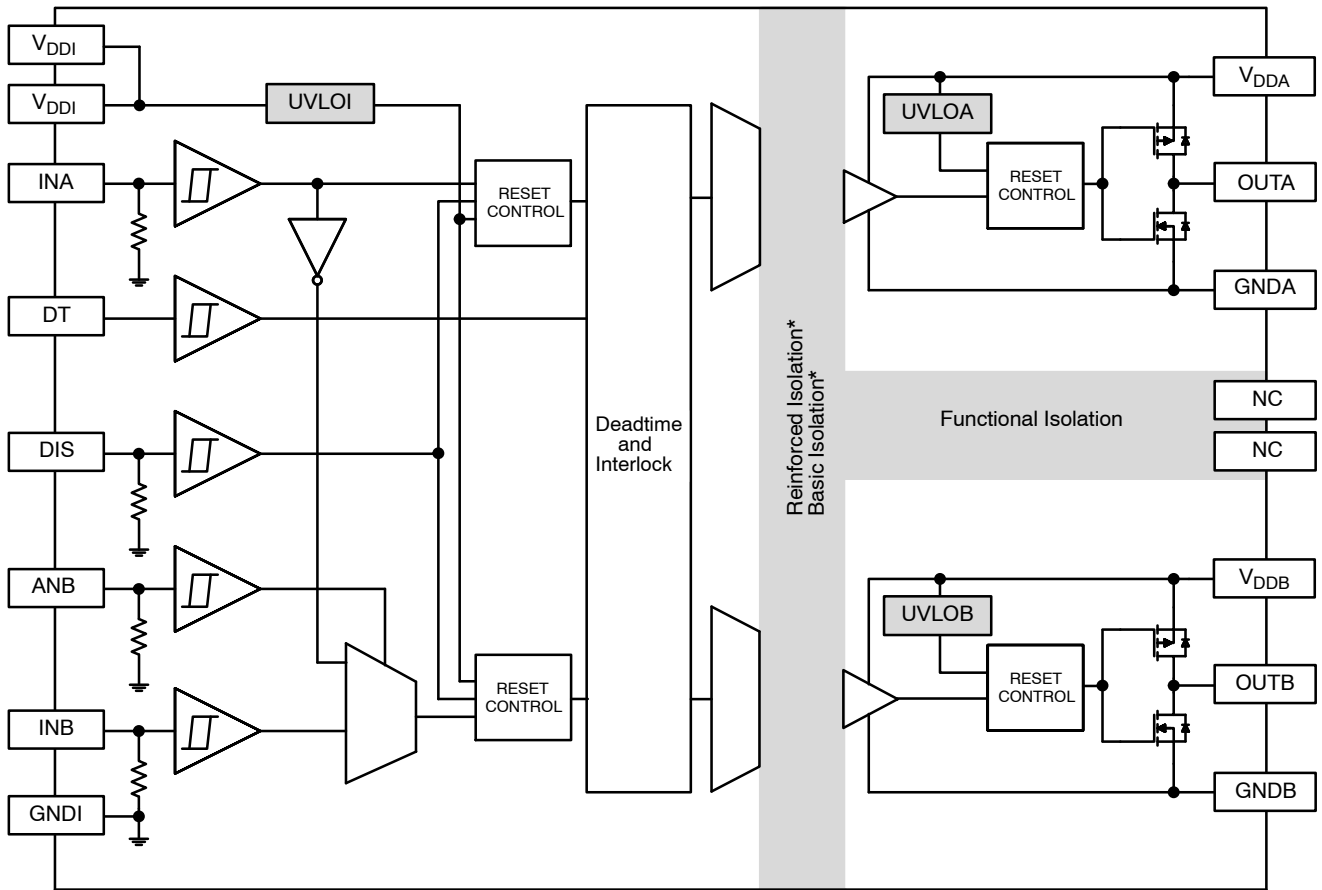

Figure 1. Simplified Block Diagram

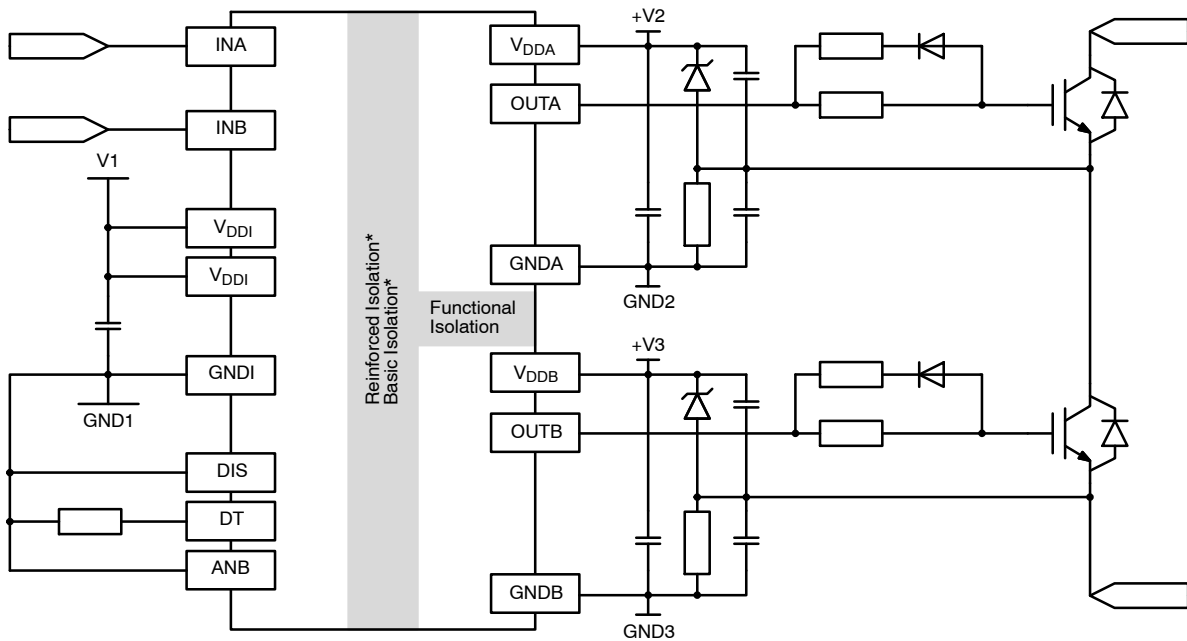

Figure 2. Typical Application, High and Low Side IGBT Gate Drive

*Depends on package variant, see Page 6, 21.

NCD57252, NCD57253, NCD57255, NCD57256, NCV57252, NCV57253, NCV57255, NCV57256

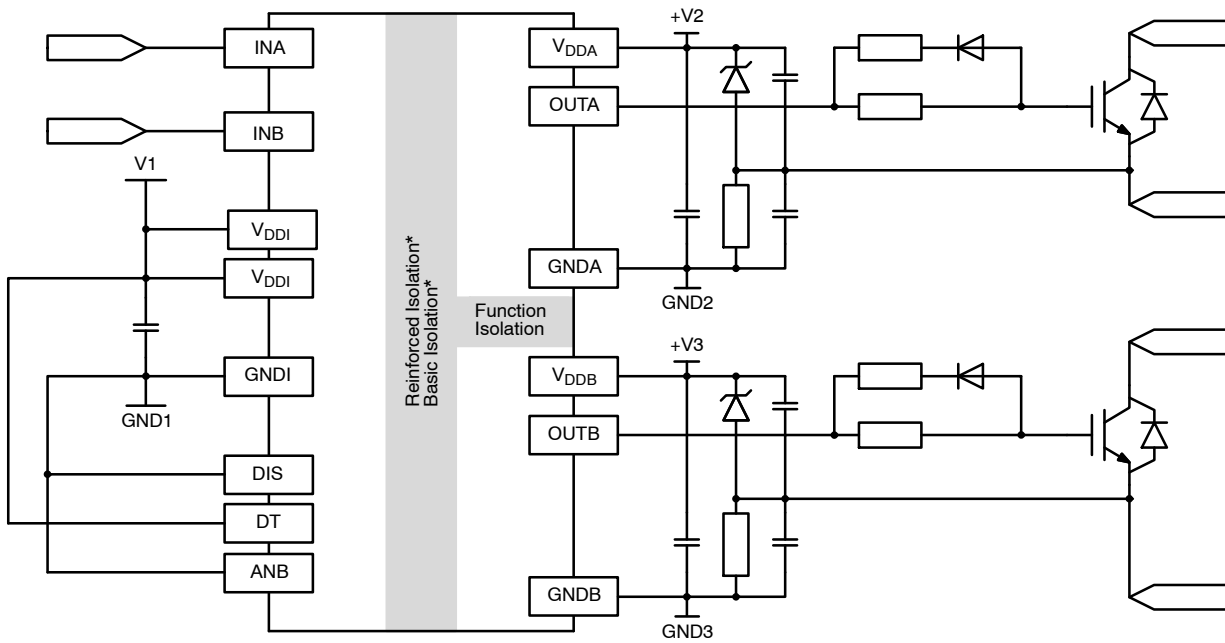

Figure 3. Typical Application, Two Channels IGBT Gate Drive

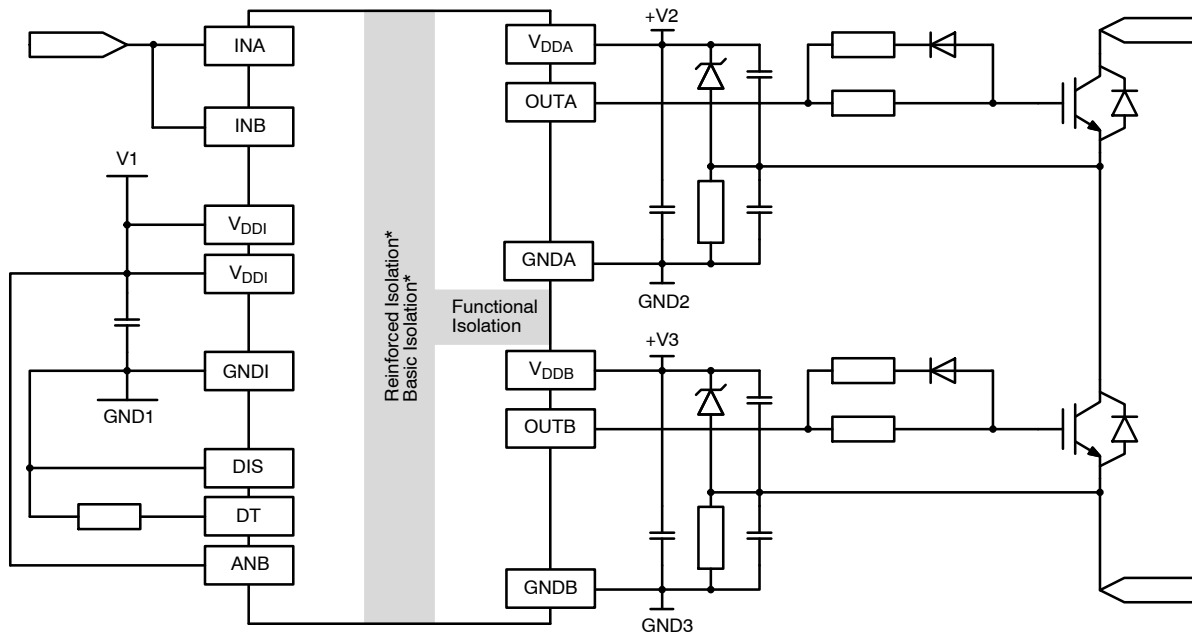

Figure 4. Typical Application, High and Low Side IGBT Gate Drive with PWM Controller

*Depends on package variant, see Page 6, 21.

**NCD57252, NCD57253, NCD57255, NCD57256, NCV57252, NCV57253, NCV57255,
NCV57256**

Table 1. FUNCTION DESCRIPTION

Pin Name	No.	I/O	Description
INA	1	Input	A non-inverting gate driver input that defines OUTA. It has an equivalent pull-down resistor of 125 kΩ to ensure that output is low in the absence of an input signal. A positive or negative going pulse with pulse width longer than maximum value of t_{MIN2} is required at INA before OUTA reacts. The input logic levels scale with V_{DDI} up to $V_{DDI} = 5$ V. With V_{DDI} above 5 V the input logic levels stay the same as for $V_{DDI} = 5$ V. Maximum voltage on this pin is V_{DDI} .
INB	2	Input	A non-inverting gate driver input that defines OUTB. It has an equivalent pull-down resistor of 125 kΩ to ensure that output is low in the absence of an input signal. A positive or negative going pulse with pulse width longer than maximum value of t_{MIN2} is required at INB before OUTB reacts. The input logic levels scale with V_{DDI} up to $V_{DDI} = 5$ V. With V_{DDI} above 5 V the input logic levels stay the same as for $V_{DDI} = 5$ V. Maximum voltage on this pin is V_{DDI} .
V_{DDI}	3, 8	Power	Low voltage side power supply. A good quality bypassing capacitor is required from this pin to GNDI and should be placed close to the pins for best results. The under voltage lockout (UVLOI) circuit enables the device to operate at power on when a typical supply voltage higher than $V_{UVLOI-OUT-ON}$ is present. Please see Figure 7 and 8 for more details.
GNDI	4	Power	Low voltage side ground.
DIS	5	Input	A high level on disable pin turns both OUTA and OUTB low simultaneously regardless of the states of INA, INB, DT and ANB. Minimum pulse width filter and propagation delays apply. It has an equivalent pull-down resistor of 125 kΩ to ensure that OUTA and OUTB react to INA, INB, DT and ANB in the absence of an input signal. The input logic levels scale with V_{DDI} up to $V_{DDI} = 5$ V. With V_{DDI} above 5 V the input logic levels stay the same as for $V_{DDI} = 5$ V. Maximum voltage on this pin is V_{DDI} .
DT	6	Input	A deadtime pin is used to configure the two outputs sequence. The deadtime (t_{DT}) and interlocking logic between INA and INB is defined by the value of the external resistor (R_{DT}) connected between DT pin and GNDI. The deadtime can be estimated as $t_{DT} (ns) \approx 10 \times R_{DT} (k\Omega)$. If DT pin is pulled up to V_{DDI} for disabling the deadtime and interlocking logic the OUTA and OUTB can be high simultaneously. Minimum deadtime will be observed between OUTA and OUTB when DT pin is left floating. Allowed resistance between this pin and GNDI is in range of 5 to 500 kΩ. Maximum voltage on this pin is V_{DDI} . Corresponding waveforms are on Figure 5.
ANB	7	Input	A high signal on ANB (A-and-B) pin enables OUTA and OUTB as complementary outputs from one PWM input signal on INA. INB must be connected to INA when ANB is high. ANB should be kept low when OUTA and OUTB are controlled individually by INA, INB. It has an equivalent pull-down resistor of 100 k to ensure that ANB pin will not be floating. Leaving this pin floating for proper security features is not recommended. The input logic levels scale with V_{DDI} up to $V_{DDI} = 5$ V. With V_{DDI} above 5 V the input logic levels stay the same as for $V_{DDI} = 5$ V. Maximum voltage on this pin is V_{DDI} .
GNDB	9	Power	Ground for channel B.
OUTB	10	Output	Output of channel B on the high voltage side. It has galvanic isolation from low voltage side and from channel A. OUTB provides the appropriate drive voltage and source/sink current to the IGBT/MOSFET gate. OUTB is actively pulled low during startup, when DIS is high and under UVLOB, UVLOI condition. INB must be connected to INA when ANB is high. There is interlocking logic that prevents OUTA and OUTB cross conduction when DT pin is not connected to V_{DDI} .
V_{DDB}	11	Power	High voltage side power supply for channel B. A good quality bypassing capacitor is required from this pin to GNDB and should be placed close to the pins for best results. The under voltage lockout (UVLOB) circuit enables the device to operate at power on when a typical supply voltage higher than $V_{UVLOB-OUT-ON}$ is present. Please see Figure 9 and 10 for more details.
NC	12, 13	-	Not connected internally.
GND A	14	Power	Ground for channel A.
OUTA	15	Output	Output of channel A on the high voltage side. It has galvanic isolation from low voltage side and from channel B. OUTA provides the appropriate drive voltage and source/sink current to the IGBT/MOSFET gate. OUTA is actively pulled low during startup, when DIS is high and under UVLOA, UVLOI condition. There is interlocking logic that prevents OUTA and OUTB cross conduction when DT pin is not connected to V_{DDI} .

**NCD57252, NCD57253, NCD57255, NCD57256, NCV57252, NCV57253, NCV57255,
NCV57256**

Table 1. FUNCTION DESCRIPTION (continued)

Pin Name	No.	I/O	Description
V _{DDA}	16	Power	High voltage side power supply for channel A. A good quality bypassing capacitor is required from this pin to GNDA and should be placed close to the pins for best results. The under voltage lockout (UVLOA) circuit enables the device to operate at power on when a typical supply voltage higher than V _{UVLOA-OUT-ON} is present. Please see Figure 9 and 10 for more details.

Table 2. SAFETY AND INSULATION RATINGS

Symbol	Parameter	Min	Typ	Max	Unit
	Installation Classifications per DIN VDE 0110/1.89 Table 1 Rated Mains Voltage	< 150 V _{RMS}	–	I–IV	–
		< 300 V _{RMS}	–	I–IV	–
		< 450 V _{RMS}	–	I–IV	–
		< 600 V _{RMS}	–	I–IV	–
		< 1000 V _{RMS}	–	I–III	–
CTI	Comparative Tracking Index (DIN IEC 112/VDE 0303 Part 1)	600	–	–	
	Climatic Classification	–	40/100/21	–	
	Pollution Degree (DIN VDE 0110/1.89)	–	2	–	
V _{PR}	Input-to-Output Test Voltage, Method b, V _{IORM} × 1.875 = V _{PR} , 100% Production Test with t _m = 1 s, Partial Discharge < 5 pC	2250	–	–	V _{PK}
V _{IORM}	Maximum Repetitive Peak Voltage	1200	–	–	V _{PK}
V _{IOWM}	Maximum Working Insulation Voltage	870	–	–	V _{RMS}
V _{IOTM}	Highest Allowable Over Voltage SOIC–16 (NCx 57255, NCx 57256) SOIC–16WB (NCx 57252, NCx 57253)	4200	–	–	V _{PK}
		8400	–	–	
E _{CR}	External Creepage SOIC–16 (NCx 57255, NCx 57256) SOIC–16WB (NCx 57252, NCx 57253)	4.0	–	–	mm
		8.0	–	–	
E _{CL}	External Clearance SOIC–16 (NCx 57255, NCx 57256) SOIC–16WB (NCx 57252, NCx 57253)	4.0	–	–	mm
		8.0	–	–	
DTI	Insulation Thickness SOIC–16 (NCx 57255, NCx 57256) SOIC–16WB (NCx 57252, NCx 57253)	8.65	–	–	μm
		17.3	–	–	
T _{Case}	Safety Limit Values – Maximum Values in Failure; Case Temperature	150	–	–	°C
P _{S,INPUT}	Safety Limit Values – Maximum Values in Failure; Input Power	264	–	–	mW
P _{S,OUTPUT}	Safety Limit Values – Maximum Values in Failure; Output Power SOIC–16 (NCx 57255, NCx 57256) SOIC–16WB (NCx 57252, NCx 57253)	796	–	–	mW
		1136	–	–	
R _{IO}	Insulation Resistance at TS, V _{IO} = 500 V	10 ⁹	–	–	Ω

NCD57252, NCD57253, NCD57255, NCD57256, NCV57252, NCV57253, NCV57255, NCV57256

Table 3. ABSOLUTE MAXIMUM RATINGS (Note 1) Over operating free-air temperature range unless otherwise noted

Symbol	Parameter	Minimum	Maximum	Unit
V _{DDI} -GNDI	Supply voltage, low voltage side	-0.3	22	V
V _{DDA} -GNDA	Supply voltage, high voltage side, channel A	-0.3	36	V
V _{ddb} -GNDB	Supply voltage, high voltage side, channel B	-0.3	36	V
V _{OUTA}	Gate driver output voltage, channel A	GNDA - 0.3	V _{DDA} + 0.3	V
V _{OUTB}	Gate driver output voltage, channel B	GNDB - 0.3	V _{ddb} + 0.3	V
I _{PK-SRC}	Gate-driver output sourcing current (maximum pulse width = 10 μs, minimum period = 5 ms, V _{DDA} - GNDA = V _{ddb} - GNDB = 15 V) (NCx57252, NCx57253) (NCx57255, NCx57256)	- -	6.5 3.5	A
I _{PK-SNK}	Gate-driver output sinking current (maximum pulse width = 10 μs, minimum period = 5 ms, V _{DDA} - GNDA = V _{ddb} - GNDB = 15 V) (NCx57252, NCx57253) (NCx57255, NCx57256)	- -	6.5 3.5	A
t _{CLP}	Maximum Short Circuit Clamping Time (I _{OUTA_CLAMP} = I _{OUTB_CLAMP} = 500 mA)	-	10	μs
V _{LIM} -GNDI	Voltage at INA, INB, DIS, DT, ANB	-0.3	V _{DDI} + 0.3	V
PD	Power Dissipation (Note 3) SOIC-16 (NCx 57255, NCx 57256) SOIC-16WB (NCx 57252, NCx 57253)	- -	1400 1060	mW
T _{J(max)}	Maximum Junction Temperature	-40	150	°C
T _{STG}	Storage Temperature Range	-65	150	°C
ESDHBM	ESD Capability, Human Body Model (Note 4)	-	±4	kV
ESDCDM	ESD Capability, Charged Device Model (Note 4)	-	±2	kV
MSL	Moisture Sensitivity Level	-	1	-
T _{SLD}	Lead Temperature Soldering Reflow, Pb-Free Versions (Note 5)	-	260	°C

Stresses exceeding those listed in the Maximum Ratings table may damage the device. If any of these limits are exceeded, device functionality should not be assumed, damage may occur and reliability may be affected.

1. Refer to ELECTRICAL CHARACTERISTICS and APPLICATION INFORMATION for Safe Operating Area.
2. The minimum value is verified by characterization with a single pulse of 100 mA for 100 μs.
3. The value is estimated for ambient temperature 25°C and junction temperature 150°C, 650 mm², 1 oz copper, 2 surface layers and 2 internal power plane layers. Power dissipation is affected by the PCB design and ambient temperature.
4. This device series incorporates ESD protection and is tested by the following methods:
ESD Human Body Model tested per AEC-Q100-002 (EIA/JESD22-A114).
ESD Charged Device Model tested per AEC-Q100-011 (EIA/JESD22-C101).
Latchup Current Maximum Rating: ≤ 100 mA per JEDEC standard: JESD78, 25°C.
5. For information, please refer to our Soldering and Mounting Techniques Reference Manual, SOLDERRM/D.

Table 4. THERMAL CHARACTERISTICS

Parameter	Conditions	Symbol	Value	Unit
Thermal Resistance, Junction-to-Air SOIC-16 (NCx 57255, NCx 57256)	100 mm ² , 2 oz Copper, 1 Surface Layer	R _{θJA}	164	°C/W
	100 mm ² , 2 oz Copper, 2 Surface Layers and 2 Internal Power Plane Layers		118	
Thermal Resistance, Junction-to-Air SOIC-16WB (NCx 57252, NCx 57253)	100 mm ² , 2 oz Copper, 1 Surface Layer	R _{θJA}	81	°C/W
	100 mm ² , 2 oz Copper, 2 Surface Layers and 2 Internal Power Plane Layers		57	

NCD57252, NCD57253, NCD57255, NCD57256, NCV57252, NCV57253, NCV57255, NCV57256

Table 5. RECOMMENDED OPERATING RANGES (Note 6)

Symbol	Parameter	Minimum	Maximum	Unit
V _{DDI-GNDI}	Supply voltage, low voltage side	UVLOI	20	V
V _{DDA-GNDA}	Supply voltage, high voltage side, channel A	UVLOA	32	V
V _{DDB-GNDB}	Supply voltage, high voltage side, channel B	UVLOB	32	V
V _{IN}	Logic Input Voltage at INA, INB, DIS, DT, ANB	GNDI	V _{DDI}	V
dV _{ISO} /dt	Common Mode Transient Immunity (CMTI)	100		kV/μs
T _A	Ambient Temperature	-40	125	°C

Functional operation above the stresses listed in the Recommended Operating Ranges is not implied. Extended exposure to stresses beyond the Recommended Operating Ranges limits may affect device reliability.

6. Refer to ELECTRICAL CHARACTERISTICS and APPLICATION INFORMATION for Safe Operating Area.

Table 6. ISOLATION CHARACTERISTICS

Symbol	Parameter	Conditions	Min	Typ	Max	Unit
V _{ISO, IINPUT TO OUTPUT}	Input-Output Isolation Voltage	T _A = 25°C, Relative Humidity < 50%, t = 1.0 minute, I _{I-O} 10 A, 50 Hz (Notes 7, 8, 9) SOIC-16 (NCx 57255, NCx 57256) SOIC-16WB (NCx 57252, NCx 57253)	2500 5000	- -	- -	V _{RMS}
V _{ISO, OUTPUT TO OUTPUT}	Output-Output Isolation Voltage	T _A = 25°C, Relative Humidity < 50%, t = 1.0 minute, I _{I-O} 10 A, 50 Hz (Notes 7, 8, 9) SOIC-16 (NCx 57255, NCx 57256) SOIC-16WB (NCx 57252, NCx 57253)	1500 1500	- -	- -	V _{RMS}
R _{ISO}	Isolation Resistance	V _{I-O} = 500 V (Note 7)	10 ¹¹			Ω

7. Device is considered a two-terminal device: pins 1 to 8 are shorted together and pins 9 to 16 are shorted together.

8. 5,000 V_{RMS} for 1-minute duration is equivalent to 6,000 V_{RMS} for 1-second duration.
2,500 V_{RMS} for 1-minute duration is equivalent to 3,000 V_{RMS} for 1-second duration.

9. The input-output isolation voltage is a dielectric voltage rating per UL1577. It should not be regarded as an input-output continuous voltage rating. For the continuous working voltage rating, refer to equipment-level safety specification or DIN VDE V 0884-11 Safety and Insulation Ratings Table.

Table 7. ELECTRICAL CHARACTERISTICS V_{DDI} = 5V, V_{DDA} = V_{DDB} = 15 V

For typical values T_A = 25°C, for min/max values, T_A is the operating ambient temperature range that applies, unless otherwise noted.

Symbol	Parameter	Test Conditions	Min	Typ	Max	Unit
VOLTAGE SUPPLY						
V _{UVLOI-OUT-ON}	V _{DDI} Supply Under Voltage Output Enabled				3.1	V
V _{UVLOI-OUT-OFF}	V _{DDI} Supply Under Voltage Output Disabled		2.4			V
V _{UVLOI-HYST}	V _{DDI} Supply Voltage Output Enabled/Disabled Hysteresis		0.1			V
V _{UVLOA-OUT-ON} V _{UVLOB-OUT-ON}	V _{DDA} /V _{DDB} Supply Under Voltage Output Enabled	NCx57252/NCx57255	12.4	12.9	13.4	V
		NCx57253/NCx57256	8.6	9.1	9.6	V
V _{UVLOA-OUT-OFF} V _{UVLOB-OUT-OFF}	V _{DDA} /V _{DDB} Supply Under Voltage Output Disabled	NCx57252/NCx57255	11.5	12	12.5	V
		NCx57253/NCx57256	7.6	8.1	8.6	V
V _{UVLOA/B-HYST}	V _{DDA} /V _{DDB} Supply Voltage Output Enabled/Disabled Hysteresis		0.8	1.0		V
I _{QDDI-0}	Low Voltage Side Quiescent Current	V _{INA} = V _{INB} = 0 V			2	mA
I _{QDDI-50}	Low Voltage Side Operating Current at 50% Duty Cycle	INA PWM, INB Low (or INA Low, INB PWM), f = 200 kHz			4	mA
I _{QDDI-100}	Low Voltage Side Operating Current at 100% Duty Cycle	INA or INB High			6	mA

NCD57252, NCD57253, NCD57255, NCD57256, NCV57252, NCV57253, NCV57255, NCV57256

Table 7. ELECTRICAL CHARACTERISTICS (continued) $V_{DDI} = 5V$, $V_{DDA} = V_{DDB} = 15V$

For typical values $T_A = 25^\circ C$, for min/max values, T_A is the operating ambient temperature range that applies, unless otherwise noted.

Symbol	Parameter	Test Conditions	Min	Typ	Max	Unit
VOLTAGE SUPPLY						
I_{QDDA-0} , I_{QDDB-0}	High Voltage Side Quiescent Current	$V_{INA} = V_{INB} = 0V$, Current per Channel			2	mA
$I_{QDDA-50}$, $I_{QDDB-50}$	High Voltage Side Operating Current at 50% Duty Cycle	Current per Channel, $f = 200kHz$, $C_G = 1nF$			2	mA
$I_{QDDA-100}$, $I_{QDDB-100}$	High Voltage Side Operating Current at 100% Duty Cycle	Current per Channel			2	mA
LOGIC INPUT						
V_{INAL} , V_{INBL} , V_{DISL} , V_{ANBL}	Low Level Input Voltage	Level scale for $V_{DDI} = 3.3$ to $5V$ for $V_{DDI} > 5V$ is the same as for $V_{DDI} = 5V$			$0.3 \times V_{DDI}$	V
V_{INAH} , V_{INBH} , V_{DISH} , V_{ANBH}	High Level Input Voltage	Level scale for $V_{DDI} = 3.3$ to $5V$ for $V_{DDI} > 5V$ is the same as for $V_{DDI} = 5V$	$0.7 \times V_{DDI}$			V
$V_{INA-HYS}$, $V_{INB-HYS}$, $V_{DIS-HYS}$, $V_{ANB-HYS}$	Input Hysteresis	Level scale for $V_{DDI} = 3.3$ to $5V$ for $V_{DDI} > 5V$ is the same as for $V_{DDI} = 5V$		$0.15 \times V_{DDI}$		V
V_{INAN} , V_{INBN} , V_{DISN} , V_{ANBN} (Note 10)	Negative Input Transient	50 ns	-5			V
I_{INAH} , I_{INBH} , I_{DISH} , I_{ANBH}	Logic "1" Input Bias Current	$V_{INA} = V_{INB} = V_{DIS} = V_{ANB} =$ $V_{DDI} = 3.3V$		50		μA
I_{INAH} , I_{INBH} , I_{DISH} , I_{ANBH}	Logic "1" Input Bias Current	$V_{INA} = V_{INB} = V_{DIS} = V_{ANB} =$ $V_{DDI} = 20V$		50		μA
I_{INAL} , I_{INBL} , I_{DISL} , I_{ANBL}	Logic "0" Input Bias Current	$V_{INA} = V_{INB} = V_{DIS} = V_{ANB} = 0V$		1		μA
DRIVER OUTPUT						
V_{OUTAL1} , V_{OUTBL1} V_{OUTAL2} , V_{OUTBL2}	Output Low State	$I_{SINK} = 200mA$, $T_A = 25^\circ C$ $I_{SINK} = 200mA$, $T_A = -40^\circ C$ to $125^\circ C$		0.1	0.22 0.5	V
V_{OUTAH1} , V_{OUTBH1} V_{OUTAH2} , V_{OUTBH2}	Output High State	$I_{SRC} = 200mA$, $T_A = 25^\circ C$ $I_{SRC} = 200mA$, $T_A = -40^\circ C$ to $125^\circ C$	14.7 14.2	14.8		V
$I_{PK-SNK1}$	Peak Driver Current, Sink (Note 10) SOIC-16 (NCx 57255, NCx 57256) SOIC-16WB (NCx 57252, NCx 57253)			3.5 6.5		A
$I_{PK-SNK2}$	Peak Miller Plateau Current, Sink (Note 10) SOIC-16 (NCx 57255, NCx 57256) SOIC-16WB (NCx 57252, NCx 57253)	$V_{OUTA} = V_{OUTB} = 6V$ (near IGBT Miller Plateau)		3 6		A
$I_{PK-SRC1}$	Peak Driver Current, Source (Note 10) SOIC-16 (NCx 57255, NCx 57256) SOIC-16WB (NCx 57252, NCx 57253)			3.5 6.5		A
$I_{PK-SRC2}$	Peak Miller Plateau Current, Source (Note 7) SOIC-16 (NCx 57255, NCx 57256) SOIC-16WB (NCx 57252, NCx 57253)	$V_{OUTA} = V_{OUTB} = 9V$ (near IGBT Miller Plateau)		3 6		A
IGBT SHORT CIRCUIT CLAMPING						
$V_{CLAMP-OUTA}$, $V_{CLAMP-OUTB}$	Clamping Voltage ($V_{CLAMP-OUTA} - V_{DDA}$), ($V_{CLAMP-OUTB} - V_{DDB}$)	$I_{OUTA} = I_{OUTB} = 500mA$ (pulse test, $t_{CLPmax} = 10\mu s$)		0.4	0.6	V

NCD57252, NCD57253, NCD57255, NCD57256, NCV57252, NCV57253, NCV57255, NCV57256

Table 7. ELECTRICAL CHARACTERISTICS (continued) $V_{DDI} = 5V$, $V_{DDA} = V_{DDB} = 15V$

For typical values $T_A = 25^\circ C$, for min/max values, T_A is the operating ambient temperature range that applies, unless otherwise noted.

Symbol	Parameter	Test Conditions	Min	Typ	Max	Unit
DYNAMIC CHARACTERISTIC						
$t_{PD-ON-A}$	OUTA High Propagation Delay	$C_{LOAD} = 10\text{ nF}$, V_{INAH} to 10% of Output Change for $PW > 150\text{ ns}$	40	60	80	ns
$t_{PD-OFF-A}$	OUTA Low Propagation Delay	$C_{LOAD} = 10\text{ nF}$, V_{INAL} to 90% of Output Change for $PW > 150\text{ ns}$	40	60	80	ns
$t_{DISTORT-A}$	Propagation Delay Distortion (Channel A) ($t_{PD-ON-A} - t_{PD-OFF-A}$)	$PW > 150\text{ ns}$	-20	0	20	ns
$t_{PD-ON-B}$	OUTB High Propagation Delay	$C_{LOAD} = 10\text{ nF}$, V_{INBH} to 10% of Output Change for $PW > 150\text{ ns}$	40	60	80	ns
$t_{PD-OFF-B}$	OUTB Low Propagation Delay	$C_{LOAD} = 10\text{ nF}$, V_{INBL} to 90% of Output Change for $PW > 150\text{ ns}$	40	60	80	ns
$t_{DISTORT-B}$	Propagation Delay Distortion (Channel B) ($t_{PD-ON-B} - t_{PD-OFF-B}$)	$PW > 150\text{ ns}$	-20	0	20	ns
$t_{DISTORT-ON}$	Rising Edge Propagation Delay Distortion ($t_{PD-ON-A} - t_{PD-ON-B}$)	$PW > 150\text{ ns}$	-20	0	20	ns
$t_{DISTORT-OFF}$	Falling Edge Propagation Delay Distortion ($t_{PD-OFF-A} - t_{PD-OFF-B}$)	$PW > 150\text{ ns}$	-20	0	20	ns
t_{RISE}	Rise Time for Both Channel A and B	$C_{LOAD} = 1\text{ nF}$, 10% to 90% of Output Change		12		ns
t_{FALL}	Fall Time for Both Channel A and B	$C_{LOAD} = 1\text{ nF}$, 90% to 10% of Output Change		10		ns
t_{DT}	Deadtime between channels	DT pin Float		<20		ns
		$R_{DT} = 500\text{ k}\Omega$		5		μs
		$R_{DT} = 20\text{ k}\Omega$		200		ns
t_{DIS}	Disable Delay			60		ns
t_{MIN1}	Input Pulse Width for no output	Positive pulse (L-H-L), $T_A = 25^\circ C$			10	ns
		Negative pulse (H-L-H), $T_A = 25^\circ C$			10	ns
t_{MIN2}	Input Pulse Width for guaranteed output	Positive pulse (L-H-L), $T_A = 25^\circ C$	40			ns
		Negative pulse (H-L-H), $T_A = 25^\circ C$	40			ns
t_{UVF}	UVLOI/UVLOA/UVLOB Fall Delay	(Note 10)		1.5		μs
t_{UVR}	UVLOI/UVLOA/UVLOB Rise Delay	(Note 10)	10	20		μs

Product parametric performance is indicated in the Electrical Characteristics for the listed test conditions, unless otherwise noted. Product performance may not be indicated by the Electrical Characteristics if operated under different conditions.

10. Values based on design and/or characterization.

11. PW = Pulse Width

Modes of Operation

The NCx5725y can operate in 3 distinct modes:

1. The low-side, high-side half-bridge driver with *two* inputs and programmable dead-time.
2. The low-side, high-side half-bridge driver with *one* input and programmable dead-time.
3. The two independent (potentially overlapping) channels with two inputs.

1st mode – half-bridge driver with two inputs and adjustable dead-time is for applications where you have high-side and low-side PWM available. The driver provides interlock function to prevent activation of high-side and low-side outputs at the same time. In addition

the driver generates dead-time which is adjustable by DT pin.

The typical application schematics are on Figure 2 and 3.

- ANB pin has to be connected to GNDI in this mode.
- The dead-time is set by resistor R_{DT} connected between DT pin and GNDI. Adjusting dead-time is described in the section Dead-time (DT).

2nd mode – half-bridge driver with one input and adjustable dead-time is very similar to 1st mode but just high-side PWM is needed. The low-side PWM is internally generated by the driver. Interlock and dead-time generator works the same as in 1st mode.

NCD57252, NCD57253, NCD57255, NCD57256, NCV57252, NCV57253, NCV57255, NCV57256

- Both INA and INB have to be connected together.
- ANB pin has to be connected to V_{DDI} . This enables the internal complementary low-side PWM generator.
- The dead-time is set by resistor R_{DT} connected between DT pin and GNDI. Adjusting dead-time is described in the section Dead-time (DT).

3rd mode – driver with two independent channels and two inputs is different from previous two modes because it allows for completely independent and even overlapping PWMs to drive the outputs individually.

- The ANB pin has to be connected to GNDI.
- DT pin has to be connected to V_{DDI} . This disables the interlock function and dead-time generator and allows the overlapping PWMs. So the channel A and B can be driven completely independently.

Dead-Time (DT)

The dead-time pin is controlling the integrated interlock and dead-time generator.

- If DT pin is connected to V_{DDI} the interlock and dead-time generator are disabled. The channels A and B are completely independent.
- If DT pin is floating the interlock is enabled but dead-time generator is disabled. There is a minimal dead-time shorter than 20 ns.
- If there is a resistor R_{DT} connected between the DT pin and GNDI the interlock and dead-time generator are both

enabled. The dead-time can be adjusted in range from 200 ns ($R_{DT} \approx 20 \text{ k}\Omega$) to 5 μs ($R_{DT} \approx 500 \text{ k}\Omega$). Dead-time can be estimated by the equation $t_{DT} \text{ (ns)} \approx 10 \times R_{DT} \text{ (k}\Omega)$. With high R_{DT} values the potential noise pick-up on high impedance of R_{DT} should be considered. R_{DT} should be as close to driver pins as possible and the loop should be minimized.

- If R_{DT} is below 20 k Ω the DT is not closely following the equation but dead-times lower than 200 ns could be achieved. The lowest allowed value of $R_{DT} = 5 \text{ k}\Omega$ which reduces the dead-time to about 70 ns.

The Figures 2 and 3 illustrate the behavior of the NCx5725y in 1st mode (high-side, low-side half-bridge driver with two inputs). The outputs for various input PWM combinations are shown in Figure 5.

The dead-time is a time from low-side output going low to high-side output going high or from high-side output going low to low side output going high. The overlap is a situation where both signals are high at the same time. Overlap causes cross conduction in the half-bridge and must be avoided.

In the “Non-overlap and Dead-time are met” column in Fig. 5, the channel A PWM, INA (high-side), and channel B PWM, INB (low-side), are not overlapping and have sufficient dead-time. Therefore, the driver does not apply corrections to the signals and passes them as they are to their respective output.

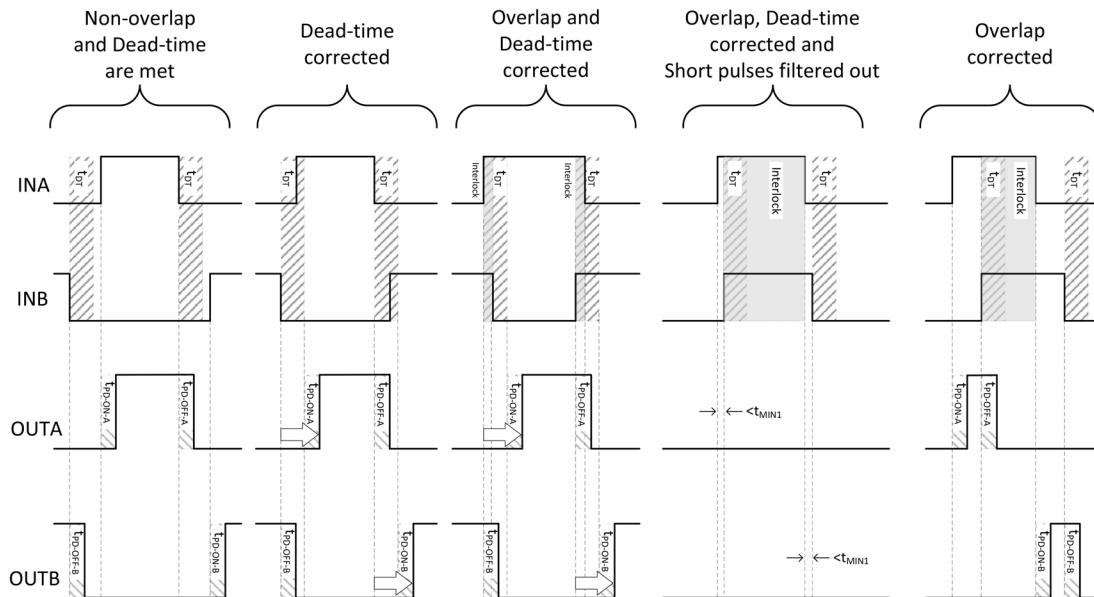

Figure 5. Deadtime, Interlock and Output Minimum Pulse Width

In the “Dead-time corrected” column, the high-side and low-side signals are not overlapping but the dead-time value is less than the value set through the DT pin. Consequently, the driver increases the dead-time value to the value set by the DT pin.

In the “Overlap and Dead-time corrected” column, the high-side and low-side input signals are high at the same time (overlapping). This condition could cause cross-conduction in the half-bridge. Therefore, the driver’s interlock function trims signal OUTB which is going low

NCD57252, NCD57253, NCD57255, NCD57256, NCV57252, NCV57253, NCV57255, NCV57256

when INA goes high, and not when INB goes low. The driver also inserts the dead-time set through DT pin, thus the output pulses are not overlapping and cross-conduction in the half-bridge is avoided.

In the “Overlap, Dead-time corrected and Short pulses filtered out” column, the high-side and low side signals are overlapping and could cause cross-conduction in the half-bridge. Therefore, the driver’s interlock function trims the output signals and a short spike remains on each output signal. If the spike is shorter than t_{MIN1} (Minimum pulse width filtering time), it will be suppressed and no output is generated.

In the “Overlap corrected” column the dead-time is met but the signals are overlapping so just the non-overlapping parts pass to the output.

Inputs INA, INB, DIS, ANB

Unused inputs should be tied to GNDI.

Input Voltage Levels

The NCx5725y has a two modes for high and low levels on all input pins:

1. For V_{DDI} from 3.3 to 5 V the high and low input levels are scaling with the V_{DDI} as stated in the Electrical characteristics table. Low input level is $0.3 \times V_{DDI}$, high input level is $0.7 \times V_{DDI}$.
2. For V_{DDI} above 5 V the high and low input levels clamp at the same value as for $V_{DDI} = 5$ V. That means the low input level is $0.3 \times 5 = 1.5$ V and the high input level is $0.7 \times 5 = 3.5$ V.

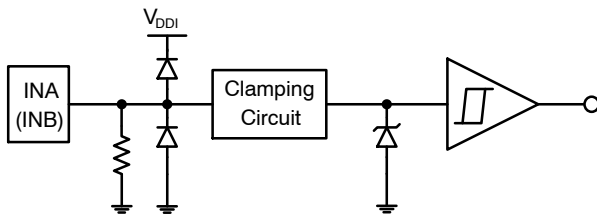

Figure 6. Input Pin Structure

Edge Triggered Inputs

The INA, INB and DIS inputs are activated by a signal edge (edge triggered), not with signal level. This means that after power cycling the driver, a rising edge has to occur on INA, INB for OUTA and OUTB to go high, respectively. The same conditions apply if the output signals are disabled through the DIS pin. Therefore, after DIS signal goes low, a rising edge has to occur on INA, INB for OUTA and OUTB to go high, respectively.

Under Voltage Lockout UVLOI, UVLOA, UVLOB

UVLOA and UVLOB ensures correct driving of the gates of the IGBTs (NCx57252, NCx57255) or MOSFETs (NCx57253, NCx57256). Driving the IGBT/MOSFETs with low gate voltage causes it to switch outside the saturation region (in the linear region) which significantly increases the power losses and there is a danger of damage.

UVLOI ensures correct transmission of the signals from the primary side to the secondary side of the driver.

NCx5725y is equipped by edge triggered inputs in order to prevent output pulse trimming. Therefore, after returning from safe state to active state, a rising edge has to occur on INA, INB in order to set OUTA and OUTB high, respectively (see Figures 7, 8 and Figures 9, 10).

As a side effect of this feature is that the t_{UVR} time is always prolonged by a $t_{UVR-spread}$. The $t_{UVR-spread}$ is the delay caused by the time before next rising edge of PWM signal comes.

Another note for the t_{UVR} is that it is valid if the V_{DD2} rises from just below $V_{UVLO-OUT-OFF}$ to $V_{UVLO-OUT-ON}$. The cold-start time from $V_{DDA(B)} = 0$ V to PWM at the output is $t_{UVR} +$ startup time of the internal bias circuits. The whole time is about 20 μ s and the internal bias circuit startup time is about 10 μ s.

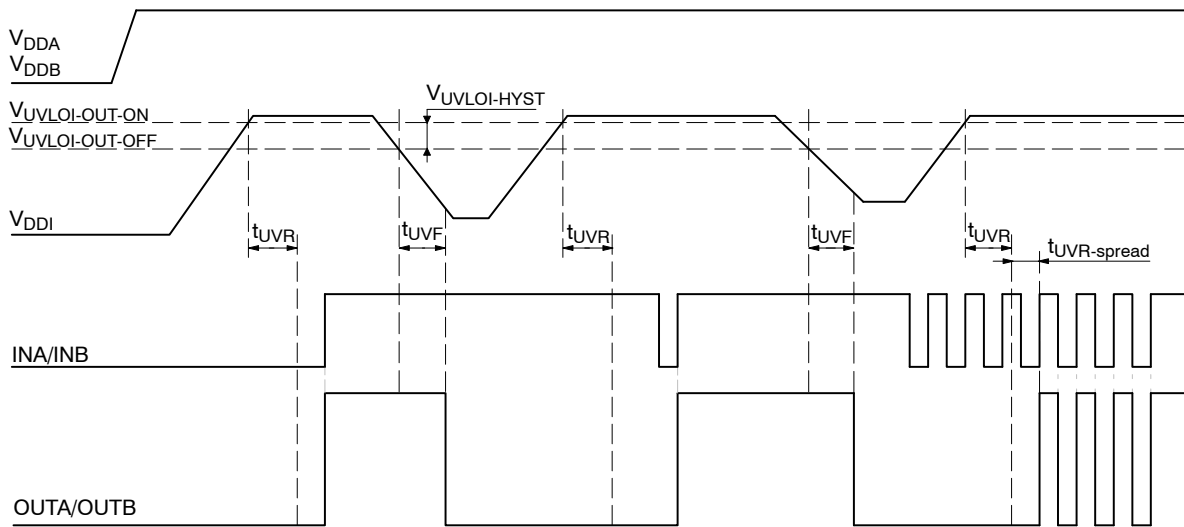

Figure 7. Output Ramp-up and Ramp-down Times during UVLOI

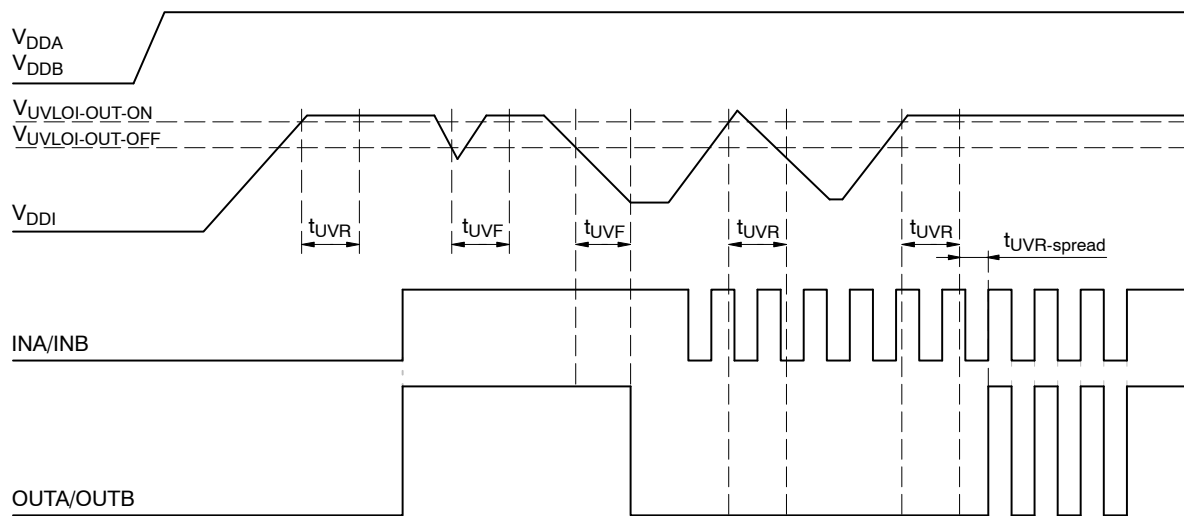

Figure 8. V_{DDI} Glitch Filtering

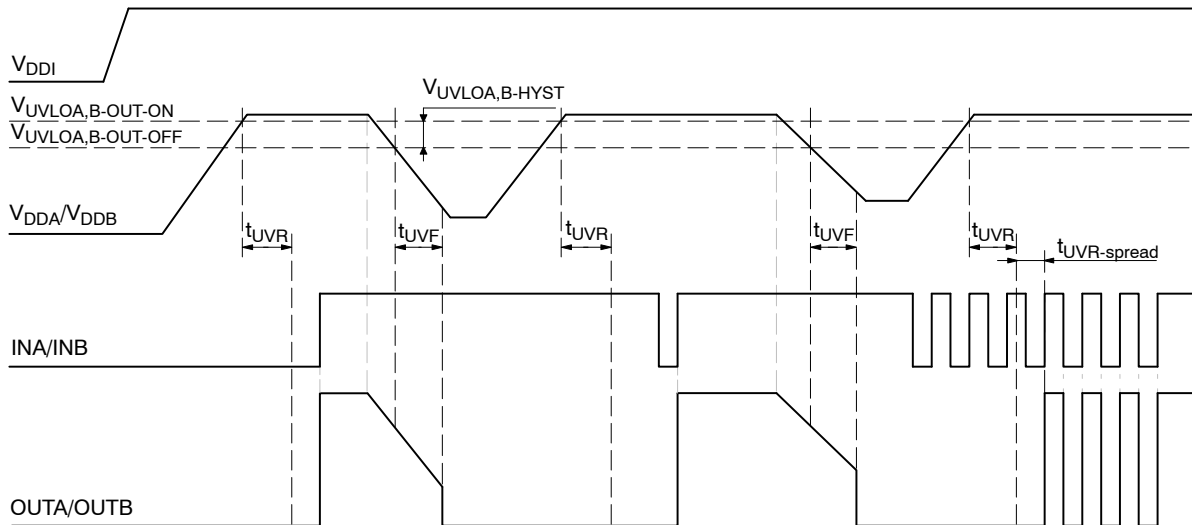

Figure 9. Output Ramp-up and Ramp-down Times during UVLOA, UVLOB

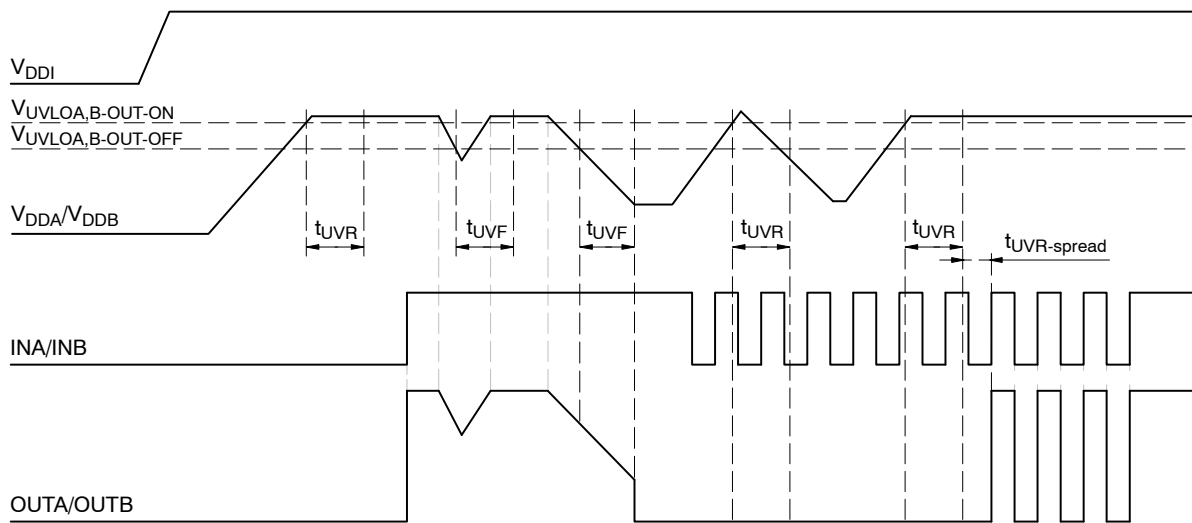

Figure 10. V_{DDA}/V_{DDB} Glitch Filtering

Power Supply

Decoupling (V_{DDI} , V_{DDA} , V_{DDB})

Suitable external power capacitors are required for reliable driving of IGBT/MOSFET gate with high current. Parallel combination of 100 nF + 4,7 μ F low ESR ceramic capacitors is optimal for a wide range of applications using IGBT/MOSFET. For reliable driving of IGBT modules (containing several parallel IGBT's) with a gate capacitance over 10 nF a higher decoupling capacity is required (typically 100 nF + 10 μ F). Capacitors should be as close as possible to the driver's power pins. The recommended layout is provided in the Figure 14.

Cooling Polygons on GNDA/GNDB

It is important to provide cooling polygons if driving IGBTs with higher gate capacitance values and using higher

switching frequencies. They have to be connected to GNDA and GNDB (See Figure 14 and 15).

Output Current on GNDA/GNDB

The NCx5725y has a high current, low-drop MOSFET output stage. It is capable of driving IGBTs with gate capacitance C_G of up to 100 nF. For optimal IGBT/MOSFET driving a few conditions have to be met:

- Low inductance (wide and short) traces from OUTA (OUTB) to R_G and to IGBT/MOSFET gate and from emitter (source) to GNDA (GNDB).
- Sufficient power rating of gate resistors R_G .
- Reasonable combination of switching frequency f and gate capacitance C_G of the IGBT/MOSFET.
- Good V_{DDA} and V_{DDB} decoupling (discussed above).
- Sufficient cooling pads (discussed above).

NCD57252, NCD57253, NCD57255, NCD57256, NCV57252, NCV57253, NCV57255, NCV57256

Low Inductance Traces

All the traces have to be as low inductance as possible due to the high current path from the driver output to IGBT/MOSFET gate. In practice that means wide tracks which are as short as possible. Traces also have to be routed in order to not create big loops. The driving path (driver output, RG, IGBT/MOSFET gate) and return path (IGBT emitter/MOSFET source, GNDA or GNDB pin) have to be routed as a pair and not enclosing other components.

Disable (DIS) Pin

DIS (disable) pin allows to deactivate both outputs independently of inputs INA, INB, DT, ANB.

If the pin is set high both OUTA and OUTB are set low immediately.

If DIS is set low, the outputs OUTA/OUTB are restored after rising edge is detected on the INA/INB respectively.

It has an internal pull-down resistor of 125 kΩ to ensure that OUTA and OUTB react to INA, INB, DT and ANB in the absence of an external signal. External pull-down resistor 10–47 kΩ is recommended to prevent unwanted DIS activation by external interference. Direct connection to GNDA is recommended if the pin is not used.

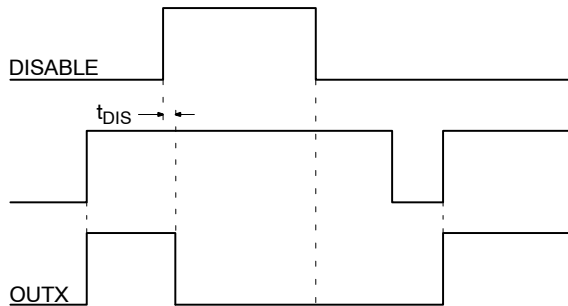

Figure 11. Disable Function

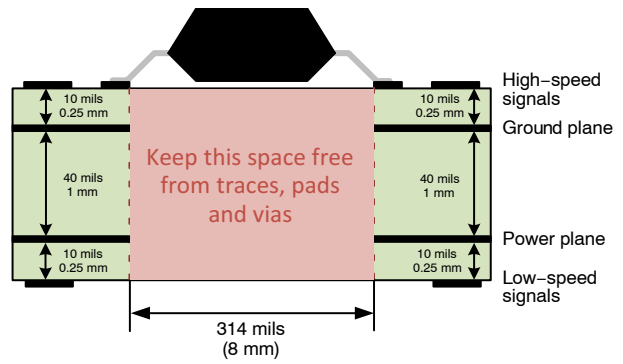

Figure 12. SOIC-16WB Recommended Layer Stack

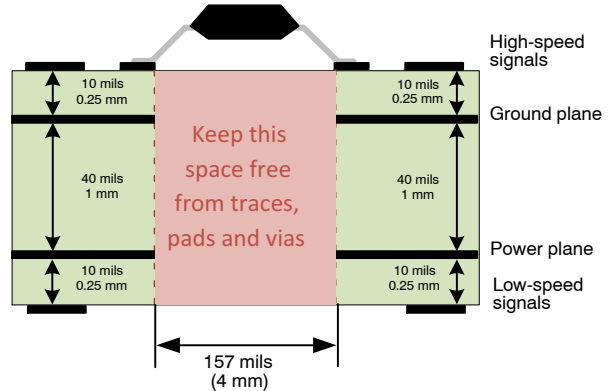
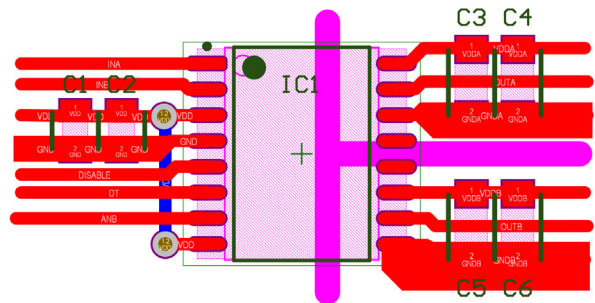

Figure 13. SOIC-16 Recommended Layer Stack



NOTE: Purple – Recommended isolation gap.

Figure 14. Recommended Layout (NCx57252, NCx57253)

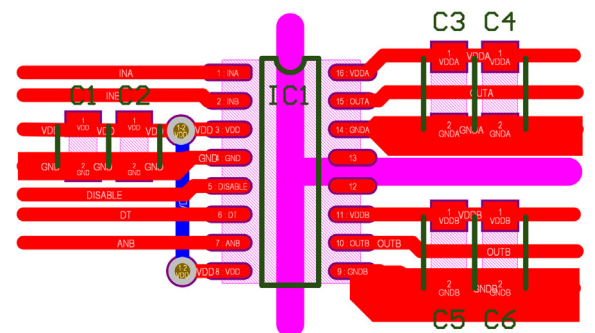
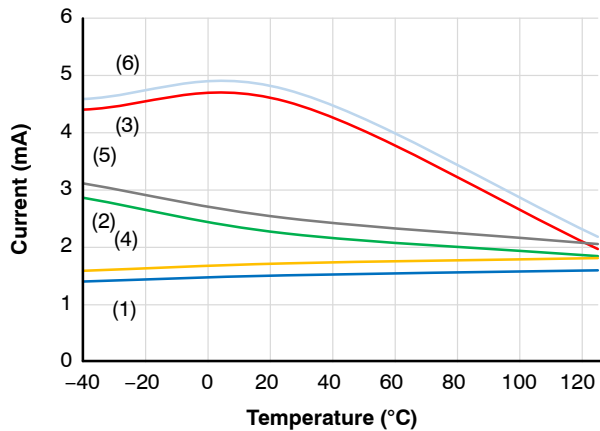

Figure 15. Recommended Layout (NCx57255, NCx57256)

TYPICAL CHARACTERISTICS



- (1) I_{QDDI-0} , $I_{NA} = 0\text{ V}$, $I_{NB} = 0\text{ V}$, $D_T = 5\text{ V}$
- (2) $I_{QDDI-50}$, $I_{NA} = 5\text{ V}/200\text{ kHz}/50\%$, $I_{NB} = 0\text{ V}$, $D_T = 5\text{ V}$
- (3) $I_{QDDI-100}$, $I_{NA} = 5\text{ V}$, $I_{NB} = 0\text{ V}$, $D_T = 5\text{ V}$
- (4) I_{QDDI-0} , $I_{NA} = 0\text{ V}$, $I_{NB} = 0\text{ V}$, $D_T = 5\text{ k}$
- (5) $I_{QDDI-50}$, $I_{NA} = 5\text{ V}/200\text{ kHz}/50\%$, $I_{NB} = 0\text{ V}$, $D_T = 5\text{ k}$
- (6) $I_{QDDI-100}$, $I_{NA} = 5\text{ V}$, $I_{NB} = 0\text{ V}$, $D_T = 5\text{ k}$

(Note: $V_{DDI} = 3.3\text{ V}$, $V_{DDA} = 15\text{ V}$, $V_{DDB} = 15\text{ V}$)

Figure 16. I_{QDDI} Supply Current, $V_{DDI} = 3.3\text{ V}$

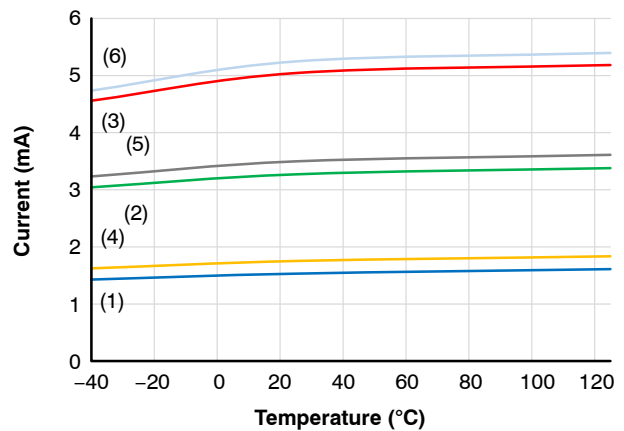

- (1) I_{QDDI-0} , $I_{NA} = 0\text{ V}$, $I_{NB} = 0\text{ V}$, $D_T = 5\text{ V}$
- (2) $I_{QDDI-50}$, $I_{NA} = 5\text{ V}/200\text{ kHz}/50\%$, $I_{NB} = 0\text{ V}$, $D_T = 5\text{ V}$
- (3) $I_{QDDI-100}$, $I_{NA} = 5\text{ V}$, $I_{NB} = 0\text{ V}$, $D_T = 5\text{ V}$
- (4) I_{QDDI-0} , $I_{NA} = 0\text{ V}$, $I_{NB} = 0\text{ V}$, $D_T = 5\text{ k}$
- (5) $I_{QDDI-50}$, $I_{NA} = 5\text{ V}/200\text{ kHz}/50\%$, $I_{NB} = 0\text{ V}$, $D_T = 5\text{ k}$
- (6) $I_{QDDI-100}$, $I_{NA} = 5\text{ V}$, $I_{NB} = 0\text{ V}$, $D_T = 5\text{ k}$

(Note: $V_{DDI} = 5\text{ V}$, $V_{DDA} = 15\text{ V}$, $V_{DDB} = 15\text{ V}$)

Figure 17. I_{QDDI} Supply Current, $V_{DDI} = 5\text{ V}$

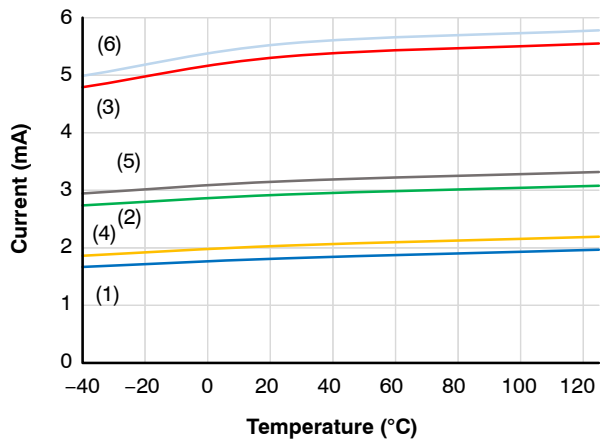

- (1) I_{QDDI-0} , $I_{NA} = 0\text{ V}$, $I_{NB} = 0\text{ V}$, $D_T = 5\text{ V}$
- (2) $I_{QDDI-50}$, $I_{NA} = 5\text{ V}/200\text{ kHz}/50\%$, $I_{NB} = 0\text{ V}$, $D_T = 5\text{ V}$
- (3) $I_{QDDI-100}$, $I_{NA} = 5\text{ V}$, $I_{NB} = 0\text{ V}$, $D_T = 5\text{ V}$
- (4) I_{QDDI-0} , $I_{NA} = 0\text{ V}$, $I_{NB} = 0\text{ V}$, $D_T = 5\text{ k}$
- (5) $I_{QDDI-50}$, $I_{NA} = 5\text{ V}/200\text{ kHz}/50\%$, $I_{NB} = 0\text{ V}$, $D_T = 5\text{ k}$
- (6) $I_{QDDI-100}$, $I_{NA} = 5\text{ V}$, $I_{NB} = 0\text{ V}$, $D_T = 5\text{ k}$

(Note: $V_{DDI} = 20\text{ V}$, $V_{DDA} = 15\text{ V}$, $V_{DDB} = 15\text{ V}$)

Figure 18. I_{QDDI} Supply Current, $V_{DDI} = 20\text{ V}$

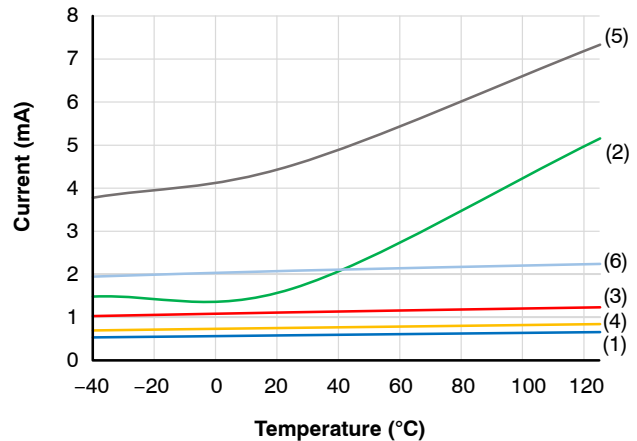

- (1) I_{QDDA-0} , $V_{DDA} = 15\text{ V}$, $I_{NA} = 0\text{ V}$, $I_{NB} = 0\text{ V}$, $D_T = 5\text{ V}$
- (2) $I_{QDDA-50}$, $V_{DDA} = 15\text{ V}$, $I_{NA} = 5\text{ V}/200\text{ kHz}/50\%$, $I_{NB} = 0\text{ V}$, $D_T = 5\text{ V}$
- (3) $I_{QDDA-100}$, $V_{DDA} = 15\text{ V}$, $I_{NA} = 5\text{ V}$, $I_{NB} = 0\text{ V}$, $D_T = 5\text{ V}$
- (4) I_{QDDA-0} , $V_{DDA} = 32\text{ V}$, $I_{NA} = 0\text{ V}$, $I_{NB} = 0\text{ V}$, $D_T = 5\text{ V}$
- (5) $I_{QDDA-50}$, $V_{DDA} = 32\text{ V}$, $I_{NA} = 5\text{ V}/200\text{ kHz}/50\%$, $I_{NB} = 0\text{ V}$, $D_T = 5\text{ V}$
- (6) $I_{QDDA-100}$, $V_{DDA} = 32\text{ V}$, $I_{NA} = 5\text{ V}$, $I_{NB} = 0\text{ V}$, $D_T = 5\text{ V}$

(Note: $V_{DDI} = 5\text{ V}$, $V_{DDB} = 15\text{ V}$)

Figure 19. I_{QDDA} Supply Current

NCD57252, NCD57253, NCD57255, NCD57256, NCV57252, NCV57253, NCV57255, NCV57256

TYPICAL CHARACTERISTICS

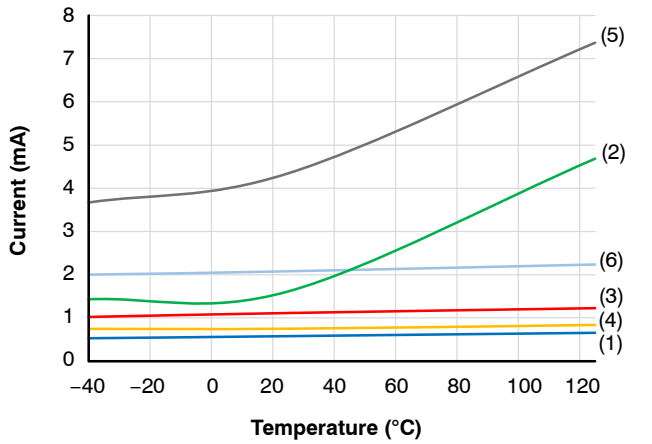

- (1) I_{QDDB-0} , $V_{DDB} = 15\text{ V}$, $I_{NA} = 0\text{ V}$, $I_{NB} = 0\text{ V}$, $D_T = 5\text{ V}$
- (2) $I_{QDDB-50}$, $V_{DDB} = 15\text{ V}$, $I_{NA} = 0\text{ V}$, $I_{NB} = 5\text{ V}/200\text{ kHz}/50\%$, $D_T = 5\text{ V}$
- (3) $I_{QDDB-100}$, $V_{DDB} = 15\text{ V}$, $I_{NA} = 0\text{ V}$, $I_{NB} = 5\text{ V}$, $D_T = 5\text{ V}$
- (4) I_{QDDB-0} , $V_{DDB} = 32\text{ V}$, $I_{NA} = 0\text{ V}$, $I_{NB} = 0\text{ V}$, $D_T = 5\text{ V}$
- (5) $I_{QDDB-50}$, $V_{DDB} = 32\text{ V}$, $I_{NA} = 0\text{ V}$, $I_{NB} = 5\text{ V}/200\text{ kHz}/50\%$, $D_T = 5\text{ V}$
- (6) $I_{QDDB-100}$, $V_{DDB} = 32\text{ V}$, $I_{NA} = 0\text{ V}$, $I_{NB} = 5\text{ V}$, $D_T = 5\text{ V}$

(Note: $V_{DDI} = 5\text{ V}$, $V_{DDA} = 15\text{ V}$)

Figure 20. I_{QDDB} Supply Current

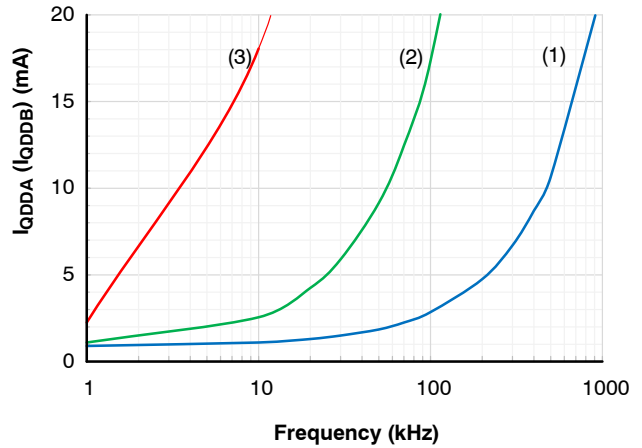

- (1) $C_G = 1\text{ nF}$ — (2) $C_G = 10\text{ nF}$ — (3) $C_G = 100\text{ nF}$

(Note: $V_{DDI} = 5\text{ V}$, $V_{DDA} = 15\text{ V}$, $V_{DDB} = 15\text{ V}$, $I_{NA} = 5\text{ V}/50\%$, $I_{NB} = 0\text{ V}$, $D_T = V_{DDI}$, $ANB = GNDI$, $DIS = GNDI$, $R_G = 0\ \Omega$)

Figure 21. I_{QDDA} (I_{QDDB}) Supply Current vs. Switching Frequency

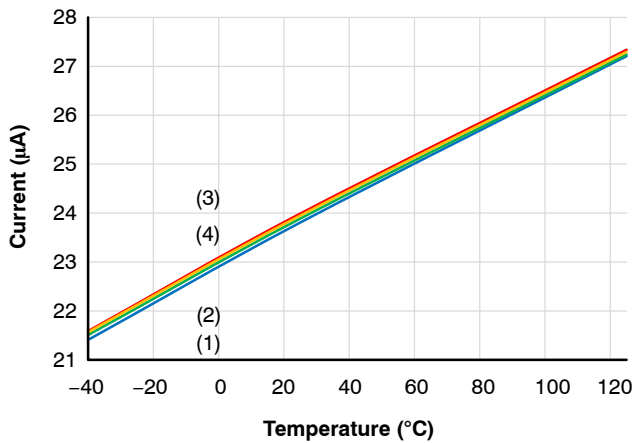

- (1) I_{INAH} — (2) I_{INBH} — (3) I_{DISH} — (4) I_{ANBH}

(Note: $V_{DDI} = V_{INA} = V_{INB} = V_{DIS} = V_{ANB} = 3.3\text{ V}$, $V_{DDA} = V_{DDB} = 15\text{ V}$)

Figure 22. Input Bias Current – Logic “1”

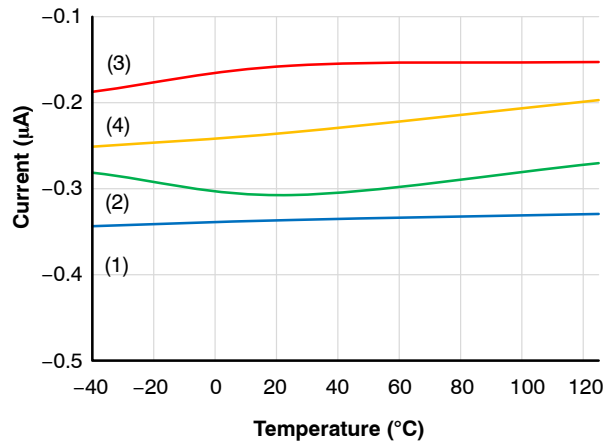

- (1) I_{INAL} — (2) I_{INBL} — (3) I_{DISL} — (4) I_{ANBL}

(Note: $V_{DDI} = 3.3\text{ V}$, $V_{INA} = V_{INB} = V_{DIS} = V_{ANB} = GNDI$, $V_{DDA} = V_{DDB} = 15\text{ V}$)

Figure 23. Input Bias Current – Logic “0”

NCD57252, NCD57253, NCD57255, NCD57256, NCV57252, NCV57253, NCV57255, NCV57256

TYPICAL CHARACTERISTICS

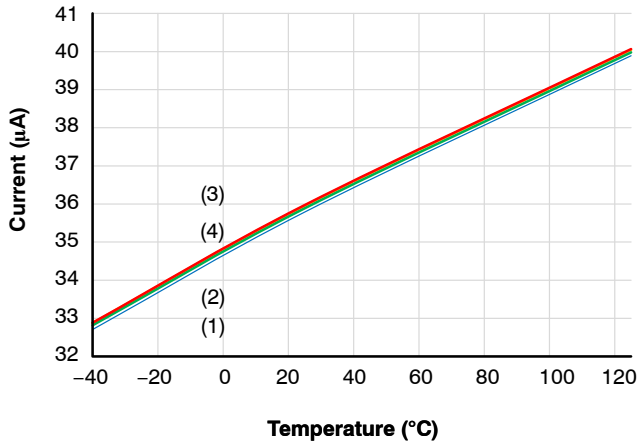

(1) I_{INAH} (2) I_{INBH} (3) I_{DISH} (4) I_{ANBH}

(Note: V_{DDI} = V_{INA} = V_{INB} = V_{DIS} = V_{ANB} = 5 V, V_{DDA} = V_{DDB} = 15 V)

Figure 24. Input Bias Current – Logic “1”

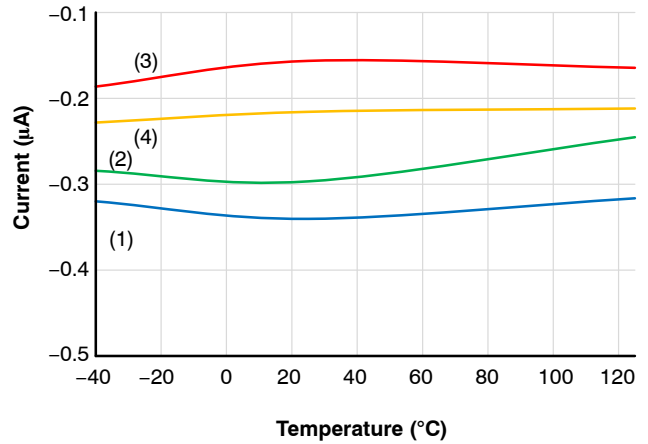

(1) I_{INAL} (2) I_{INBL} (3) I_{DISL} (4) I_{ANBL}

(Note: V_{DDI} = 5 V, V_{INA} = V_{INB} = V_{DIS} = V_{ANB} = GNDI, V_{DDA} = V_{DDB} = 15 V)

Figure 25. Input Bias Current – Logic “0”

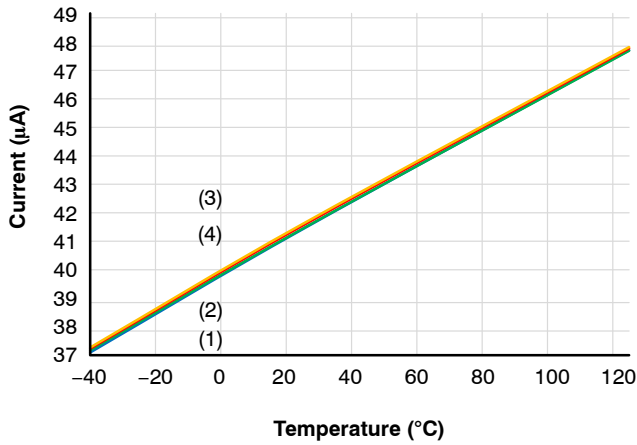

(1) I_{INAH} (2) I_{INBH} (3) I_{DISH} (4) I_{ANBH}

(Note: V_{DDI} = V_{INA} = V_{INB} = V_{DIS} = V_{ANB} = 20 V, V_{DDA} = V_{DDB} = 15 V)

Figure 26. Input Bias Current – Logic “1”

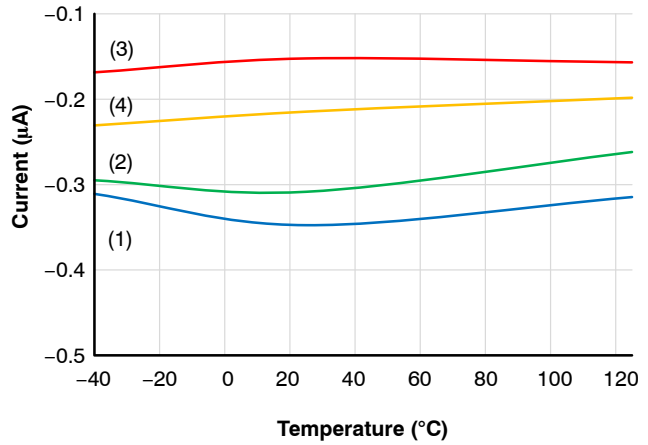

(1) I_{INAL} (2) I_{INBL} (3) I_{DISL} (4) I_{ANBL}

(Note: V_{DDI} = 20 V, V_{INA} = V_{INB} = V_{DIS} = V_{ANB} = GNDI, V_{DDA} = V_{DDB} = 15 V)

Figure 27. Input Bias Current – Logic “0”

NCD57252, NCD57253, NCD57255, NCD57256, NCV57252, NCV57253, NCV57255, NCV57256

TYPICAL CHARACTERISTICS

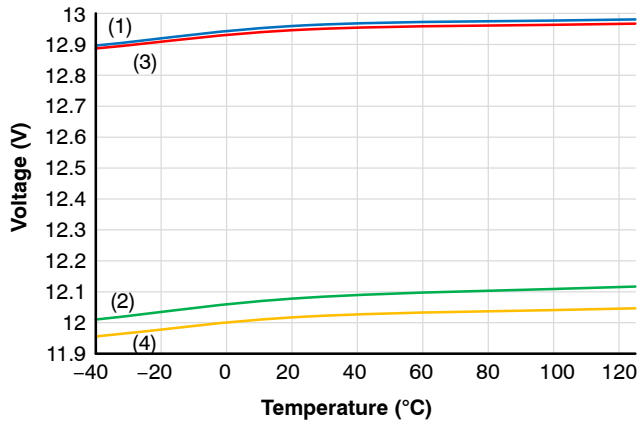

(1) $V_{UVLOA-OUT-ON}$ (2) $V_{UVLOA-OUT-OFF}$
 (3) $V_{UVLOB-OUT-ON}$ (4) $V_{UVLOB-OUT-OFF}$

Figure 28. NCx57252 UVLOA and UVLOB Threshold Voltage

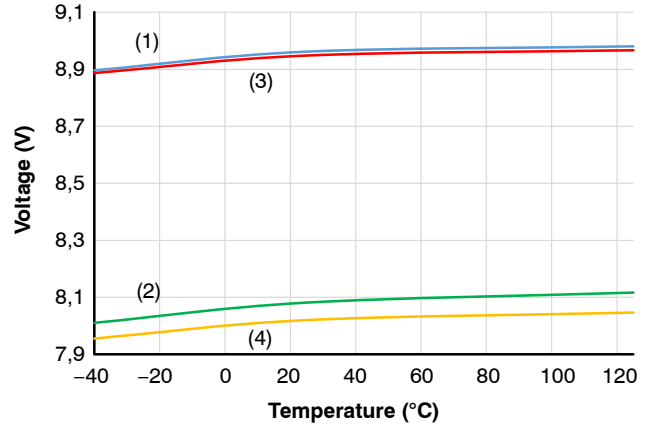

(1) $V_{UVLOA-OUT-ON}$ (2) $V_{UVLOA-OUT-OFF}$
 (3) $V_{UVLOB-OUT-ON}$ (4) $V_{UVLOB-OUT-OFF}$

Figure 29. NCx57253 UVLOA and UVLOB Threshold Voltage

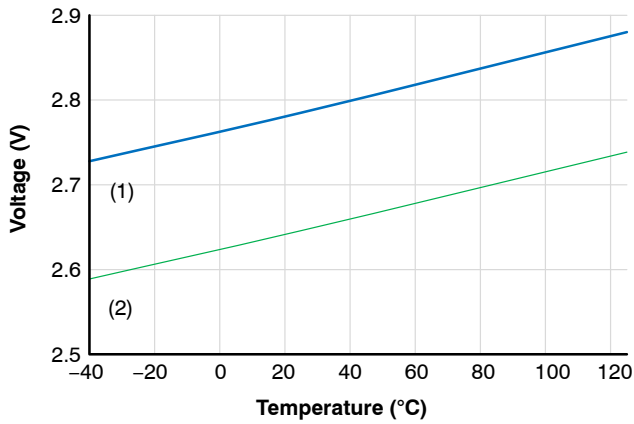

(1) $V_{UVLOI-OUT-ON}$ (2) $V_{UVLOI-OUT-OFF}$

Figure 30. UVLOI Threshold Voltage

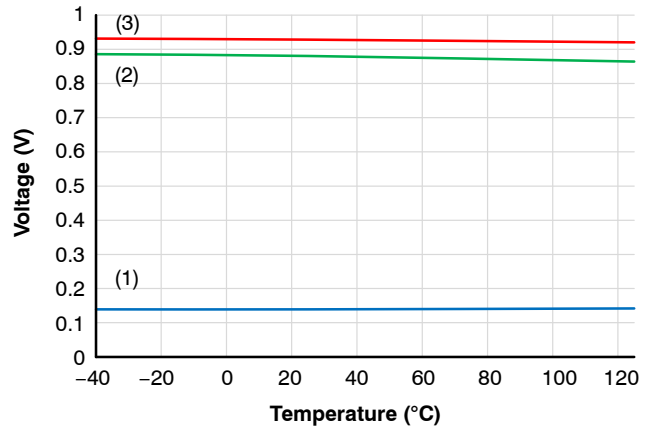

(1) $V_{UVLOI-HYST}$ (2) $V_{UVLOA-HYST}$ (3) $V_{UVLOB-HYST}$

Figure 31. UVLOx Enable/Disable Voltage Hysteresis

NCD57252, NCD57253, NCD57255, NCD57256, NCV57252, NCV57253, NCV57255, NCV57256

TYPICAL CHARACTERISTICS

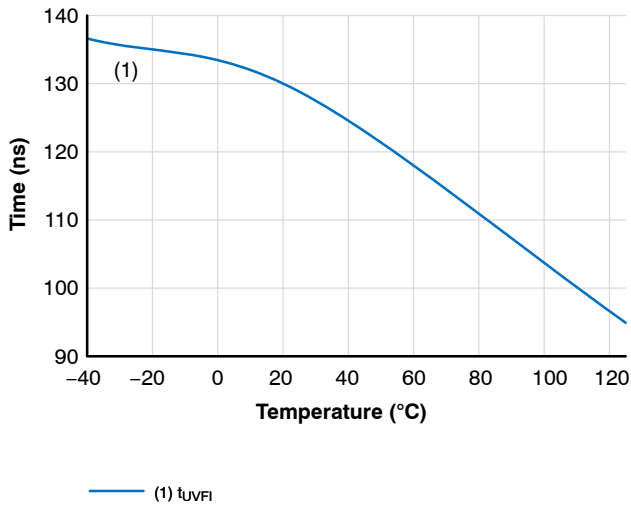

Figure 32. UVLOI Fall Delay

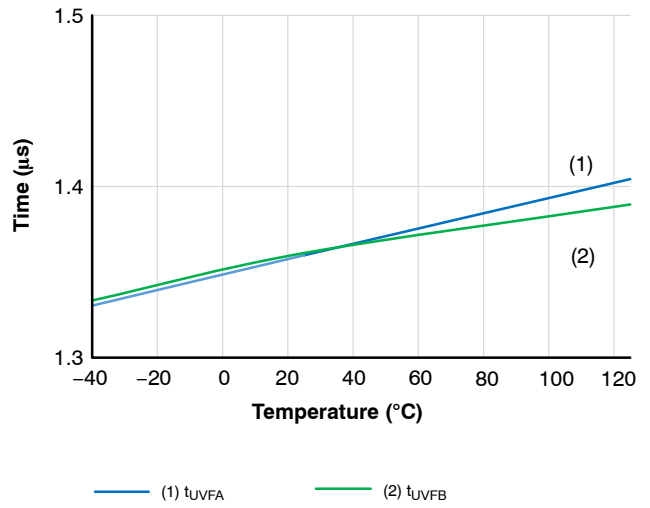

Figure 33. UVLOA and UVLOB Fall Delay

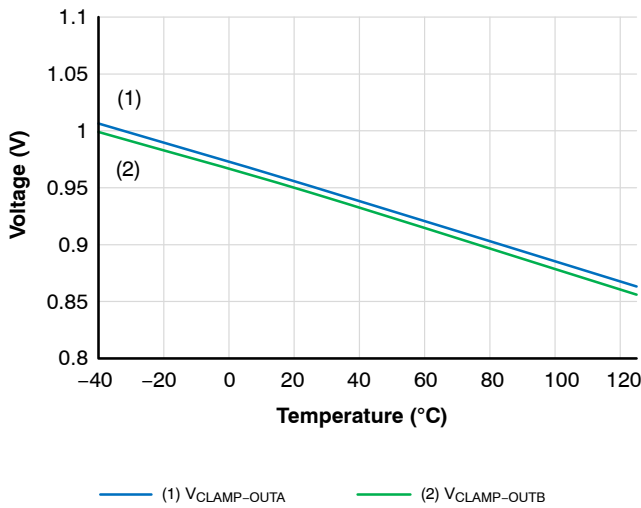

Figure 34. IGBT Short Circuit Clamping Voltage

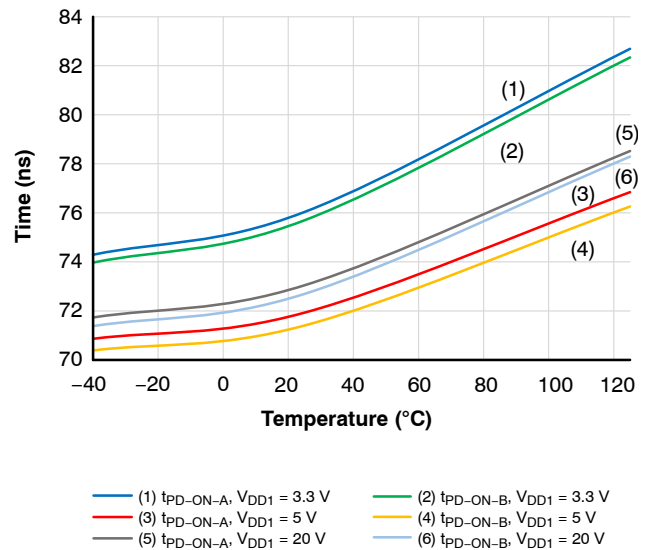
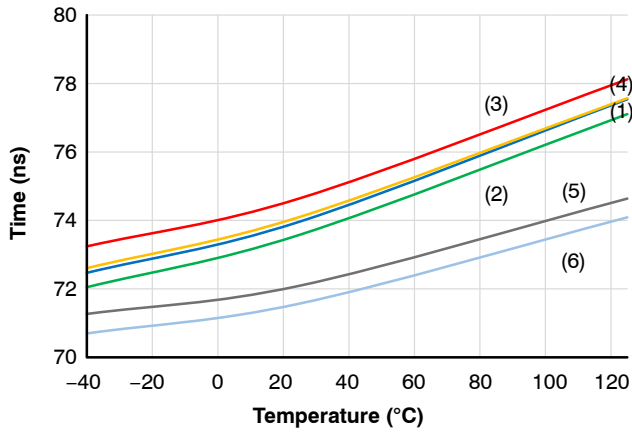

Figure 35. Propagation Delay Turn-on

NCD57252, NCD57253, NCD57255, NCD57256, NCV57252, NCV57253, NCV57255, NCV57256

TYPICAL CHARACTERISTICS



(1) $t_{PD-OFF-A}$, $V_{DD1} = 3.3\text{ V}$ (2) $t_{PD-OFF-B}$, $V_{DD1} = 3.3\text{ V}$
 (3) $t_{PD-OFF-A}$, $V_{DD1} = 5\text{ V}$ (4) $t_{PD-OFF-B}$, $V_{DD1} = 5\text{ V}$
 (5) $t_{PD-OFF-A}$, $V_{DD1} = 20\text{ V}$ (6) $t_{PD-OFF-B}$, $V_{DD1} = 20\text{ V}$

Figure 36. Propagation Delay Turn-off

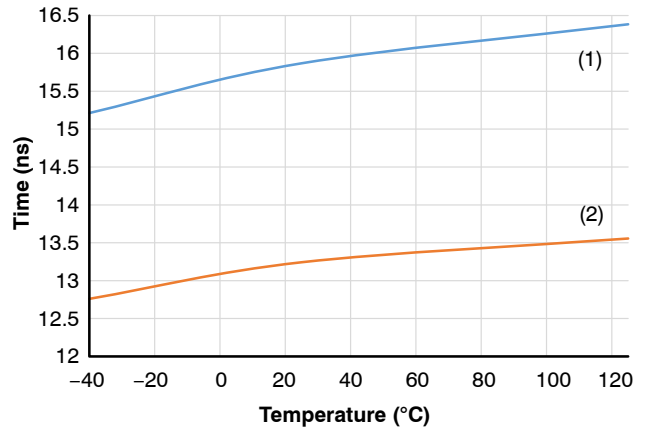

(1) t_{RISE} (2) t_{FALL}

Figure 37. Rise Time / Fall Time

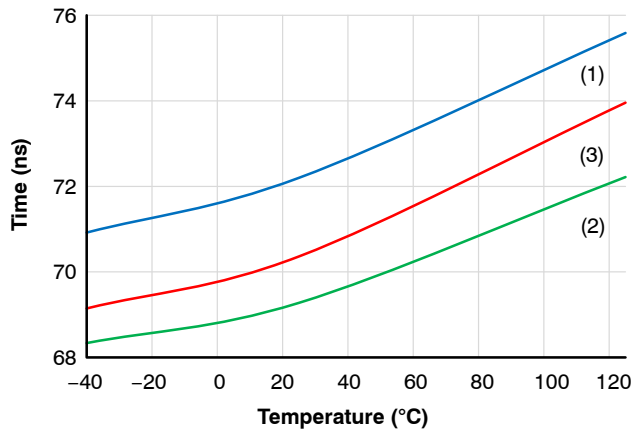

(1) t_{DIS} , $V_{DD1} = 3.3\text{ V}$ (2) t_{DIS} , $V_{DD1} = 5\text{ V}$ (3) t_{DIS} , $V_{DD1} = 20\text{ V}$

Figure 38. Disable Delay Time

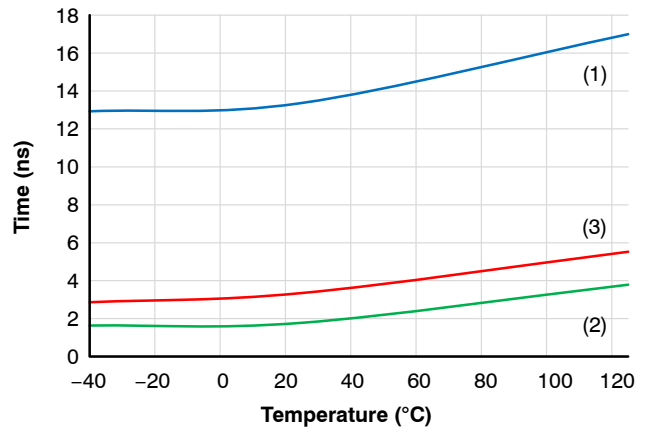

(1) t_{DT} , $V_{DD1} = 3.3\text{ V}$ (2) t_{DT} , $V_{DD1} = 5\text{ V}$ (3) t_{DT} , $V_{DD1} = 20\text{ V}$

(Note: V_{INA} is inverted from V_{INB} , $V_{DDA} = V_{DDB} = 15\text{ V}$)

Figure 39. Deadtime, DT pin FLOAT

NCD57252, NCD57253, NCD57255, NCD57256, NCV57252, NCV57253, NCV57255, NCV57256

TYPICAL CHARACTERISTICS

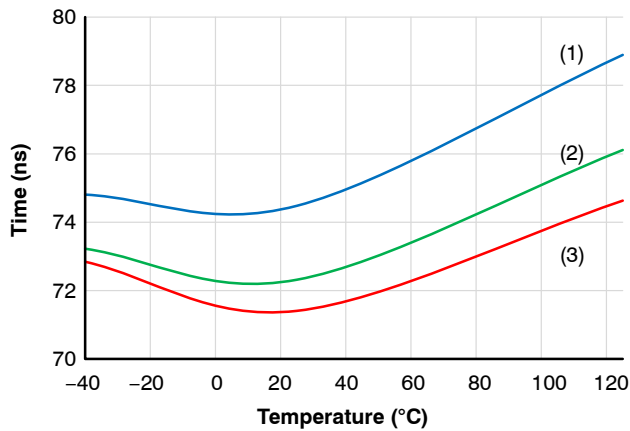

— (1) t_{DT} , $V_{DDI} = 3.3\text{ V}$ — (2) t_{DT} , $V_{DDI} = 5\text{ V}$ — (3) t_{DT} , $V_{DDI} = 20\text{ V}$

(Note: V_{INA} is inverted from V_{INB} , $V_{DDA} = V_{DDB} = 15\text{ V}$)

Figure 40. Deadtime, DT pin 5 kΩ to GNDI

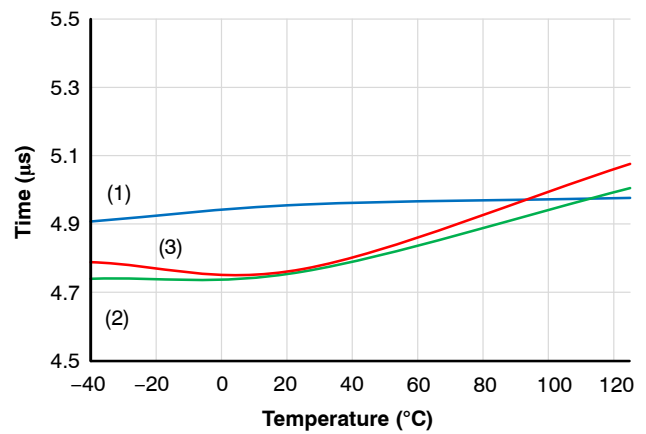

— (1) t_{DT} , $V_{DDI} = 3.3\text{ V}$ — (2) t_{DT} , $V_{DDI} = 5\text{ V}$ — (3) t_{DT} , $V_{DDI} = 20\text{ V}$

(Note: V_{INA} is inverted from V_{INB} , $V_{DDA} = V_{DDB} = 15\text{ V}$)

Figure 41. Deadtime, DT pin 500 kΩ to GNDI

ORDERING INFORMATION

Device	Package	Shipping [†]
NCD57252DWR2G	SOIC-16 Wide Body (Pb-Free)	1,000 / Tape & Reel
NCV57252DWR2G*	SOIC-16 Wide Body (Pb-Free)	1,000 / Tape & Reel
NCD57253DWR2G	SOIC-16 Wide Body (Pb-Free)	1,000 / Tape & Reel
NCV57253DWR2G*	SOIC-16 Wide Body (Pb-Free)	1,000 / Tape & Reel
NCD57255DR2G	SOIC-16 Narrow body (Pb-Free)	2,500 / Tape & Reel
NCV57255DR2G*	SOIC-16 Narrow body (Pb-Free)	2,500 / Tape & Reel
NCD57256DR2G	SOIC-16 Narrow body (Pb-Free)	2,500 / Tape & Reel
NCV57256DR2G*	SOIC-16 Narrow body (Pb-Free)	2,500 / Tape & Reel

[†]For information on tape and reel specifications, including part orientation and tape sizes, please refer to our Tape and Reel Packaging Specifications Brochure, BRD8011/D.

*NCV Prefix for Automotive and Other Applications Requiring Unique Site and Control Change Requirements; AEC-Q100 Qualified and PPAP Capable.

MECHANICAL CASE OUTLINE

PACKAGE DIMENSIONS



SOIC-16 9.90x3.90x1.50 1.27P
CASE 751B
ISSUE L

DATE 29 MAY 2024

NOTES:

1. DIMENSIONING AND TOLERANCING PER ASME Y14.5M, 2018.
2. DIMENSION IN MILLIMETERS. ANGLE IN DEGREES.
3. DIMENSIONS D AND E1 DO NOT INCLUDE MOLD PROTRUSION.
4. MAXIMUM MOLD PROTRUSION 0.15mm PER SIDE.
5. DIMENSION b DOES NOT INCLUDE DAMBAR PROTRUSION. ALLOWABLE DAMBAR PROTRUSION SHALL BE 0.127mm TOTAL IN EXCESS OF THE b DIMENSION AT MAXIMUM MATERIAL CONDITION.

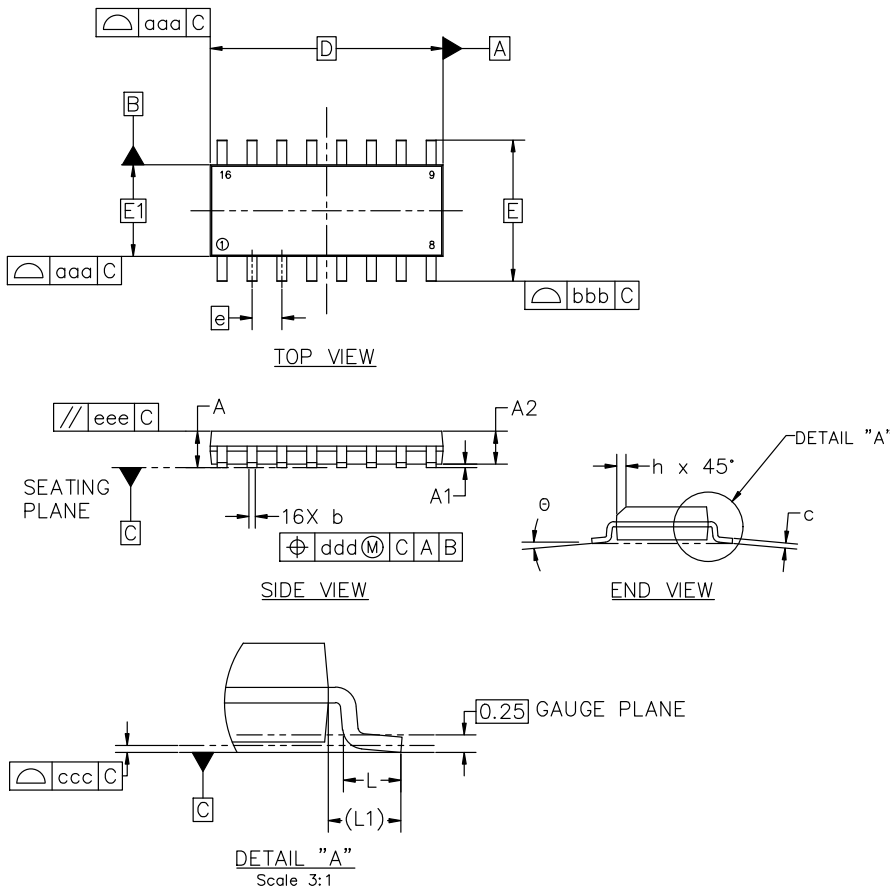

MILLIMETERS			
DIM	MIN	NOM	MAX
A	1.35	1.55	1.75
A1	0.00	0.05	0.10
A2	1.35	1.50	1.65
b	0.35	0.42	0.49
c	0.19	0.22	0.25
D	9.90 BSC		
E	6.00 BSC		
E1	3.90 BSC		
e	1.27 BSC		
h	0.25	---	0.50
L	0.40	0.83	1.25
L1	1.05 REF		
θ	0°	---	7°
TOLERANCE OF FORM AND POSITION			
aaa	0.10		
bbb	0.20		
ccc	0.10		
ddd	0.25		
eee	0.10		



RECOMMENDED MOUNTING FOOTPRINT

*FOR ADDITIONAL INFORMATION ON OUR PB-FREE STRATEGY AND SOLDERING DETAILS, PLEASE DOWNLOAD THE onsemi SOLDERING AND MOUNTING TECHNIQUES REFERENCE MANUAL, SOLDERRM/D

DOCUMENT NUMBER:	98ASB42566B	Electronic versions are uncontrolled except when accessed directly from the Document Repository. Printed versions are uncontrolled except when stamped "CONTROLLED COPY" in red.
DESCRIPTION:	SOIC-16 9.90X3.90X1.50 1.27P	PAGE 1 OF 2

onsemi and onsemi are trademarks of Semiconductor Components Industries, LLC dba onsemi or its subsidiaries in the United States and/or other countries. onsemi reserves the right to make changes without further notice to any products herein. onsemi makes no warranty, representation or guarantee regarding the suitability of its products for any particular purpose, nor does onsemi assume any liability arising out of the application or use of any product or circuit, and specifically disclaims any and all liability, including without limitation special, consequential or incidental damages. onsemi does not convey any license under its patent rights nor the rights of others.

SOIC-16 9.90x3.90x1.50 1.27P
CASE 751B
ISSUE L

DATE 29 MAY 2024

GENERIC MARKING DIAGRAM*

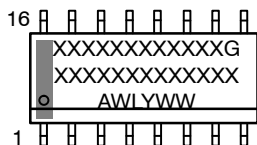

XXXXX = Specific Device Code
 A = Assembly Location
 WL = Wafer Lot
 Y = Year
 WW = Work Week
 G = Pb-Free Package

*This information is generic. Please refer to device data sheet for actual part marking. Pb-Free indicator, "G" or microdot "•", may or may not be present. Some products may not follow the Generic Marking.

<p>STYLE 1:</p> <p>PIN 1. COLLECTOR 2. BASE 3. EMITTER 4. NO CONNECTION 5. EMITTER 6. BASE 7. COLLECTOR 8. COLLECTOR 9. BASE 10. EMITTER 11. NO CONNECTION 12. EMITTER 13. BASE 14. COLLECTOR 15. EMITTER 16. COLLECTOR</p>	<p>STYLE 2:</p> <p>PIN 1. CATHODE 2. ANODE 3. NO CONNECTION 4. CATHODE 5. CATHODE 6. NO CONNECTION 7. ANODE 8. CATHODE 9. CATHODE 10. ANODE 11. NO CONNECTION 12. CATHODE 13. CATHODE 14. NO CONNECTION 15. ANODE 16. CATHODE</p>	<p>STYLE 3:</p> <p>PIN 1. COLLECTOR, DYE #1 2. BASE, #1 3. EMITTER, #1 4. COLLECTOR, #1 5. COLLECTOR, #2 6. BASE, #2 7. EMITTER, #2 8. COLLECTOR, #2 9. COLLECTOR, #3 10. BASE, #3 11. EMITTER, #3 12. COLLECTOR, #3 13. COLLECTOR, #4 14. BASE, #4 15. EMITTER, #4 16. COLLECTOR, #4</p>	<p>STYLE 4:</p> <p>PIN 1. COLLECTOR, DYE #1 2. COLLECTOR, #1 3. COLLECTOR, #2 4. COLLECTOR, #2 5. COLLECTOR, #3 6. COLLECTOR, #3 7. COLLECTOR, #4 8. COLLECTOR, #4 9. BASE, #4 10. EMITTER, #4 11. BASE, #3 12. EMITTER, #3 13. BASE, #2 14. EMITTER, #2 15. BASE, #1 16. EMITTER, #1</p>
<p>STYLE 5:</p> <p>PIN 1. DRAIN, DYE #1 2. DRAIN, #1 3. DRAIN, #2 4. DRAIN, #2 5. DRAIN, #3 6. DRAIN, #3 7. DRAIN, #4 8. DRAIN, #4 9. GATE, #4 10. SOURCE, #4 11. GATE, #3 12. SOURCE, #3 13. GATE, #2 14. SOURCE, #2 15. GATE, #1 16. SOURCE, #1</p>	<p>STYLE 6:</p> <p>PIN 1. CATHODE 2. CATHODE 3. CATHODE 4. CATHODE 5. CATHODE 6. CATHODE 7. CATHODE 8. CATHODE 9. ANODE 10. ANODE 11. ANODE 12. ANODE 13. ANODE 14. ANODE 15. ANODE 16. ANODE</p>	<p>STYLE 7:</p> <p>PIN 1. SOURCE N-CH 2. COMMON DRAIN (OUTPUT) 3. COMMON DRAIN (OUTPUT) 4. GATE P-CH 5. COMMON DRAIN (OUTPUT) 6. COMMON DRAIN (OUTPUT) 7. COMMON DRAIN (OUTPUT) 8. SOURCE P-CH 9. SOURCE P-CH 10. COMMON DRAIN (OUTPUT) 11. COMMON DRAIN (OUTPUT) 12. COMMON DRAIN (OUTPUT) 13. GATE N-CH 14. COMMON DRAIN (OUTPUT) 15. COMMON DRAIN (OUTPUT) 16. SOURCE N-CH</p>	

DOCUMENT NUMBER:	98ASB42566B	Electronic versions are uncontrolled except when accessed directly from the Document Repository. Printed versions are uncontrolled except when stamped "CONTROLLED COPY" in red.
DESCRIPTION:	SOIC-16 9.90X3.90X1.50 1.27P	PAGE 2 OF 2

onsemi and onsemi are trademarks of Semiconductor Components Industries, LLC dba onsemi or its subsidiaries in the United States and/or other countries. onsemi reserves the right to make changes without further notice to any products herein. onsemi makes no warranty, representation or guarantee regarding the suitability of its products for any particular purpose, nor does onsemi assume any liability arising out of the application or use of any product or circuit, and specifically disclaims any and all liability, including without limitation special, consequential or incidental damages. onsemi does not convey any license under its patent rights nor the rights of others.

MECHANICAL CASE OUTLINE PACKAGE DIMENSIONS



1
SCALE 1:1

SOIC-16 WB
CASE 751G
ISSUE E

DATE 08 OCT 2021

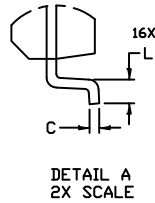
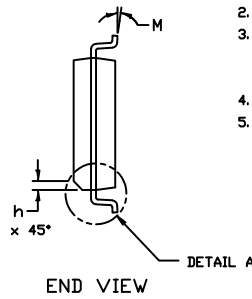
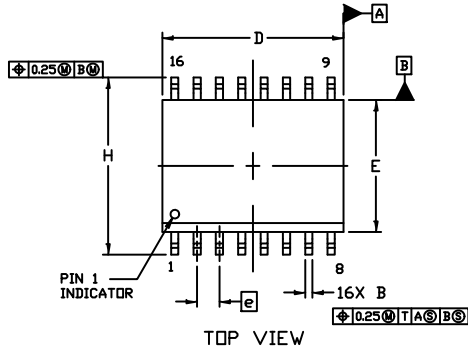

NOTES:

1. DIMENSIONING AND TOLERANCING PER ASME Y14.5M, 1994.
2. CONTROLLING DIMENSION: MILLIMETERS
3. DIMENSION b DOES NOT INCLUDE DAMBAR PROTRUSION. ALLOWABLE PROTRUSION SHALL BE 0.13 TOTAL IN EXCESS OF B DIMENSION AT MAXIMUM MATERIAL CONDITION.
4. DIMENSIONS D AND E DO NOT INCLUDE MOLD PROTRUSIONS.
5. MAXIMUM MOLD PROTRUSION OR FLASH TO BE 0.15 PER SIDE.

DIM	MILLIMETERS	
	MIN.	MAX.
A	2.35	2.65
A1	0.10	0.25
B	0.35	0.49
C	0.23	0.32
D	10.15	10.45
E	7.40	7.60
e	1.27 BSC	
H	10.05	10.55
h	0.53 REF	
L	0.50	0.90
M	0°	7°

GENERIC MARKING DIAGRAM*

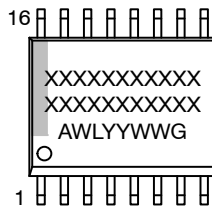

- XXXXX = Specific Device Code
- A = Assembly Location
- WL = Wafer Lot
- YY = Year
- WW = Work Week
- G = Pb-Free Package

*This information is generic. Please refer to device data sheet for actual part marking. Pb-Free indicator, "G" or microdot "▪", may or may not be present. Some products may not follow the Generic Marking.

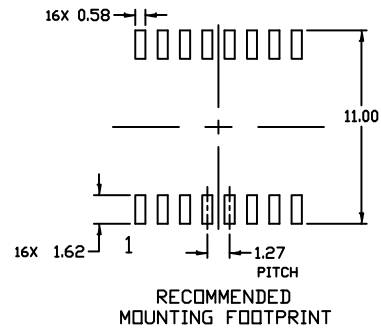

DOCUMENT NUMBER:	98ASB42567B	Electronic versions are uncontrolled except when accessed directly from the Document Repository. Printed versions are uncontrolled except when stamped "CONTROLLED COPY" in red.
DESCRIPTION:	SOIC-16 WB	PAGE 1 OF 1

onsemi and onsemi are trademarks of Semiconductor Components Industries, LLC dba onsemi or its subsidiaries in the United States and/or other countries. onsemi reserves the right to make changes without further notice to any products herein. onsemi makes no warranty, representation or guarantee regarding the suitability of its products for any particular purpose, nor does onsemi assume any liability arising out of the application or use of any product or circuit, and specifically disclaims any and all liability, including without limitation special, consequential or incidental damages. onsemi does not convey any license under its patent rights nor the rights of others.

onsemi, **Onsemi**, and other names, marks, and brands are registered and/or common law trademarks of Semiconductor Components Industries, LLC dba "**onsemi**" or its affiliates and/or subsidiaries in the United States and/or other countries. **onsemi** owns the rights to a number of patents, trademarks, copyrights, trade secrets, and other intellectual property. A listing of **onsemi**'s product/patent coverage may be accessed at www.onsemi.com/site/pdf/Patent-Marking.pdf. **onsemi** reserves the right to make changes at any time to any products or information herein, without notice. The information herein is provided "as-is" and **onsemi** makes no warranty, representation or guarantee regarding the accuracy of the information, product features, availability, functionality, or suitability of its products for any particular purpose, nor does **onsemi** assume any liability arising out of the application or use of any product or circuit, and specifically disclaims any and all liability, including without limitation special, consequential or incidental damages. Buyer is responsible for its products and applications using **onsemi** products, including compliance with all laws, regulations and safety requirements or standards, regardless of any support or applications information provided by **onsemi**. "Typical" parameters which may be provided in **onsemi** data sheets and/or specifications can and do vary in different applications and actual performance may vary over time. All operating parameters, including "Typicals" must be validated for each customer application by customer's technical experts. **onsemi** does not convey any license under any of its intellectual property rights nor the rights of others. **onsemi** products are not designed, intended, or authorized for use as a critical component in life support systems or any FDA Class 3 medical devices or medical devices with a same or similar classification in a foreign jurisdiction or any devices intended for implantation in the human body. Should Buyer purchase or use **onsemi** products for any such unintended or unauthorized application, Buyer shall indemnify and hold **onsemi** and its officers, employees, subsidiaries, affiliates, and distributors harmless against all claims, costs, damages, and expenses, and reasonable attorney fees arising out of, directly or indirectly, any claim of personal injury or death associated with such unintended or unauthorized use, even if such claim alleges that **onsemi** was negligent regarding the design or manufacture of the part. **onsemi** is an Equal Opportunity/Affirmative Action Employer. This literature is subject to all applicable copyright laws and is not for resale in any manner.

ADDITIONAL INFORMATION

TECHNICAL PUBLICATIONS:

Technical Library: www.onsemi.com/design/resources/technical-documentation
onsemi Website: www.onsemi.com

ONLINE SUPPORT: www.onsemi.com/support

For additional information, please contact your local Sales Representative at www.onsemi.com/support/sales