

**SERIES: PQAE50 | DESCRIPTION: DC-DC CONVERTER****FEATURES**

- up to 50 W isolated output
- 2:1 input range (18~36 Vdc, 36~75 Vdc)
- single, regulated output
- 1,500 Vdc isolation
- short circuit, over current, and over voltage protection
- input under voltage protection
- remote on/off
- wide operating temperature range -40~105°C
- efficiency up to 92%
- EN/BS EN 62368 certified



MODEL	input voltage		output voltage (Vdc)	output current		output power max (W)	ripple and noise <sup>2</sup> max (mVp-p)	efficiency <sup>3</sup> typ (%)
	typ (Vdc)	range <sup>1</sup> (Vdc)		min (A)	max (A)			
PQAE50-D24-S3 <sup>4</sup>	24	18~36	3.3	0.5	10.0	33	200	91
PQAE50-D24-S5 <sup>4</sup>	24	18~36	5	0.5	10.0	50	200	91
PQAE50-D24-S12 <sup>4</sup>	24	18~36	12	0.208	4.167	50	250	91
PQAE50-D24-S15 <sup>4</sup>	24	18~36	15	0.167	3.333	50	250	91
PQAE50-D24-S24 <sup>4</sup>	24	18~36	24	0.104	2.083	50	300	91
PQAE50-D48-S3	48	36~75	3.3	0	10.0	33	200	91
PQAE50-D48-S5	48	36~75	5	0	10.0	50	200	91
PQAE50-D48-S12	48	36~75	12	0	4.167	50	250	92
PQAE50-D48-S15	48	36~75	15	0	3.333	50	250	92
PQAE50-D48-S24	48	36~75	24	0	2.083	50	350	92

Notes:

1. Minimum input voltage is 1V greater for DIN rail and chassis mount models.
2. Ripple and noise are measured at 20 MHz BW by "parallel cable" method with 1  $\mu$ F ceramic and 10  $\mu$ F electrolytic capacitors on the output.
3. Measured at nominal input voltage and full load.
4. Model is not CE & UKCA certified.

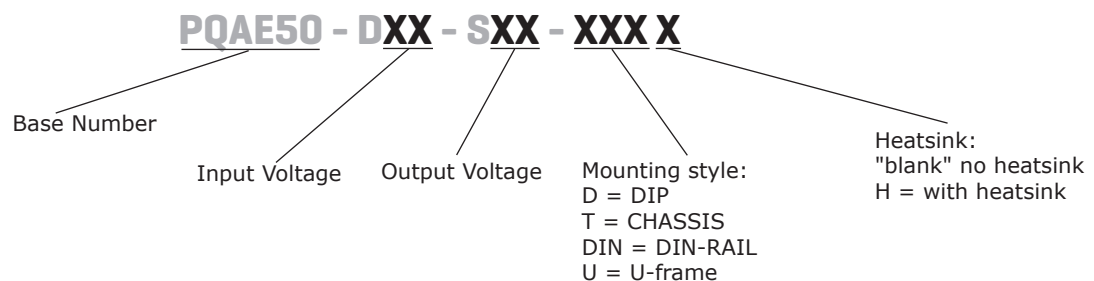
**PART NUMBER KEY**

## INPUT

parameter	conditions/description	min	typ	max	units
input voltage	24 Vdc input models	18	24	40	Vdc
	48 Vdc input models	36	48	80	Vdc
current (full load/no load)	24 Vdc input models	3.3 Vdc output model	1511/2	1545/-	mA
		5 Vdc output model	2289/3	2341/-	mA
		12 Vdc output model	2289/5	2341/-	mA
		15 Vdc output model	2289/11	2341/-	mA
		24 Vdc output model	2289/4	2341/-	mA
	48 Vdc input models	3.3 Vdc output model	756/1	773/-	mA
		5 Vdc output model	1145/2	1171/-	mA
		12 Vdc output model	1133/4	1158/-	mA
		15 Vdc output model	1133/4	1158/-	mA
		24 Vdc output model	1133/3	1158/-	mA
start-up voltage	24 Vdc input models			18	Vdc
	48 Vdc input models			36	Vdc
under voltage protection	24 Vdc input models	11	13		Vdc
	48 Vdc input models	26	30		Vdc
surge voltage	for maximum of 1 second				
	24 Vdc input models	-0.7		50	Vdc
	48 Vdc input models	-0.7		80	Vdc
start-up time	nominal input, constant load		10	120	ms
CTRL <sup>1</sup>	models ON (CTRL open or connect high level, 3~12 Vdc)				
	models OFF (CTRL connect GND or low level, 0~1.2 Vdc)				
	input current (models OFF)				
	24 Vdc input models		6	12	mA
	48 Vdc input models		2	12	mA
filter	pi filter				

Note 1. CTRL pin voltage is referenced to GND.

## OUTPUT

parameter	conditions/description	min	typ	max	units
line regulation	full load, input voltage from low to high		±0.2	±0.5	%
load regulation	5% to 100% load		±0.5	±1	%
voltage accuracy	5% to 100% load		±1	±3	%
switching frequency	PWM mode		300		kHz
transient recovery time	25% load step change		250	500	µs
transient response deviation	25% load step change		±3	±8	%
	3.3 & 5 Vdc output models other output models		±3	±5	%
temperature coefficient	100% load			±0.03	%/°C
trim			±10		%

## PROTECTIONS

parameter	conditions/description	min	typ	max	units
over voltage protection		110	140	160	%
over current protection		110	140	200	%
short circuit protection	continuous, auto recovery, hiccup				

**SAFETY AND COMPLIANCE**

parameter	conditions/description	min	typ	max	units
isolation voltage	input to output at 1 mA for 1 minute	1,500			Vdc
	input or output to housing at 1 mA for 1 minute	1,000			Vdc
isolation resistance	input to output at 500 Vdc	100			MΩ
isolation capacitance	input to output at 100 kHz, 0.1 Vdc		2,200		pF
safety approvals	certified to 62368: EN, IEC, BS EN				
conducted emissions	CISPR32/EN55032 CLASS B (see Fig.2 for recommended circuit)				
radiated emissions	CISPR32/EN55032 CLASS B (see Fig.2 for recommended circuit)				
ESD	IEC/EN61000-4-2 Contact ±4KV (for 18~36 Vdc) ±6KV (for 36~75 Vdc) perf. Criteria B				
radiated immunity	IEC/EN61000-4-3 10V/m perf. Criteria A				
EFT/burst	IEC/EN61000-4-4 100KHz ±2KV (see Fig.2 for recommended circuit) perf. Criteria B				
surge	IEC/EN61000-4-5 line to line ±2KV (see Fig.2 for recommended circuit) perf. Criteria B				
conducted immunity	IEC/EN61000-4-6 10 Vr.m.s perf. Criteria A				
MTBF	as per MIL-HDBK-217F @ 25°C	1,000,000			hours
RoHS	yes				

**ENVIRONMENTAL**

parameter	conditions/description	min	typ	max	units
operating temperature	see derating curve	-40		105	°C
storage temperature		-55		125	°C
storage humidity	non-condensing	5		95	%
vibration	10 ~ 150Hz, 5G, 0.75mm. along X, Y and Z			5	G

**MECHANICAL**

parameter	conditions/description	min	typ	max	units
dimensions	without heatsink:				
	horizontal package 50.80 × 25.40 × 11.80				mm
	chassis mount 76.00 × 31.50 × 21.20				mm
	DIN-Rail mounting 76.00 × 31.50 × 25.80				mm
	U-frame mounting 55.00 × 52.30 × 19.00				mm
	with heatsink:				
horizontal package 51.40 × 26.20 × 16.50				mm	
chassis mount 76.00 × 31.50 × 25.30				mm	
DIN-Rail mounting 76.00 × 31.50 × 29.90				mm	
case material	aluminum alloy				
weight	without heatsink:				
	horizontal package		42		g
	chassis mounting		65		g
	DIN-Rail mounting		85		g
	U-frame mounting		70		g
	with heatsink:				
horizontal package		50		g	
chassis mounting		73		g	
DIN-Rail mounting		93		g	

## MECHANICAL DRAWING

units: mm[inch]  
 pin diameter tolerance:  $\pm 0.10[\pm 0.004]$   
 general tolerance:  $\pm 0.50[\pm 0.020]$

PIN CONNECTIONS	
PIN	Function
1	CTRL
2	GND
3	Vin
4	+Vo
5	0V
6	Trim

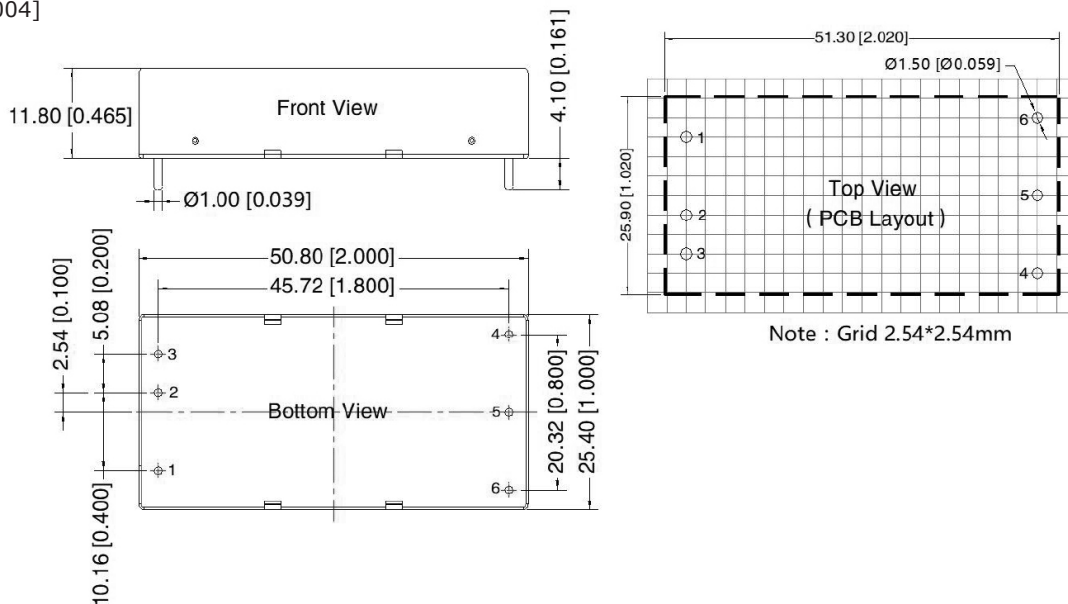

### CHASSIS MOUNT

units: mm[inch]  
 wire range: 24-12 AWG  
 tightening torque: Max 0.4 N·m  
 general tolerance:  $\pm 1.00[\pm 0.039]$

PIN OUT	
PIN	Function
1	CTRL
2	GND
3	Vin
4	+Vo
5	0V
6	Trim

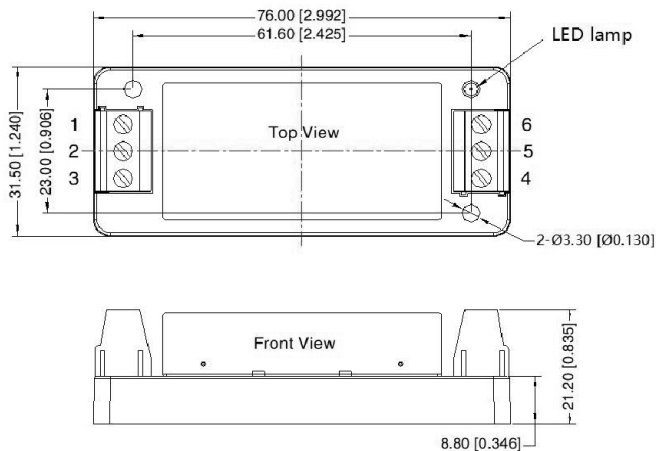

### DIN-RAIL MOUNT

units: mm[inch]  
 mounting rail: TS35  
 wire range: 24-12 AWG  
 tightening torque: Max 0.4 N·m  
 general tolerance:  $\pm 1.00[\pm 0.039]$

PIN OUT	
PIN	Function
1	CTRL
2	GND
3	Vin
4	+Vo
5	0V
6	Trim

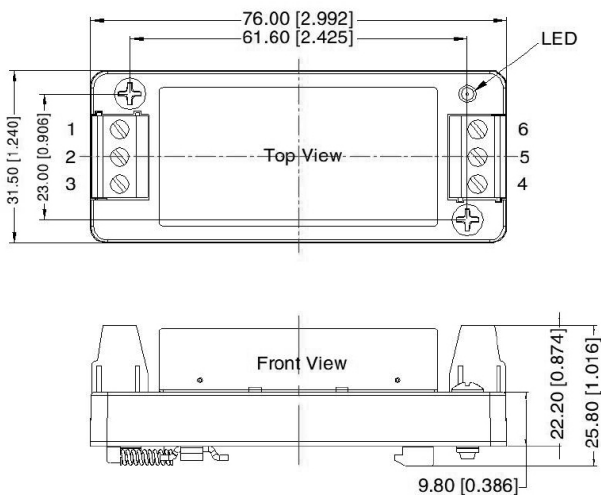

## MECHANICAL DRAWING (CONTINUED)

### U-FRAME

units: mm[inch]  
 wire range: 24-12 AWG  
 tightening torque: Max 0.4 N·m  
 general tolerance:  $\pm 1.00[\pm 0.039]$

PIN CONNECTIONS	
PIN	Function
1	GND
2	Vin
3	CTRL
4	Case
5	NC
6	+Vo
7	0V
8	Trim

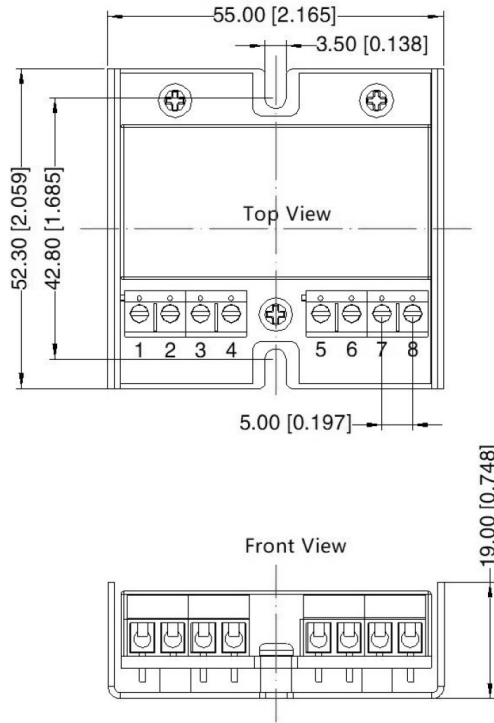

### WITH HEATSINK

units: mm[inch]  
 pin diameter tolerance:  $\pm 0.10[\pm 0.004]$   
 general tolerance:  $\pm 0.50[\pm 0.020]$

PIN CONNECTIONS	
PIN	Function
1	CTRL
2	GND
3	Vin
4	+Vo
5	0V
6	Trim

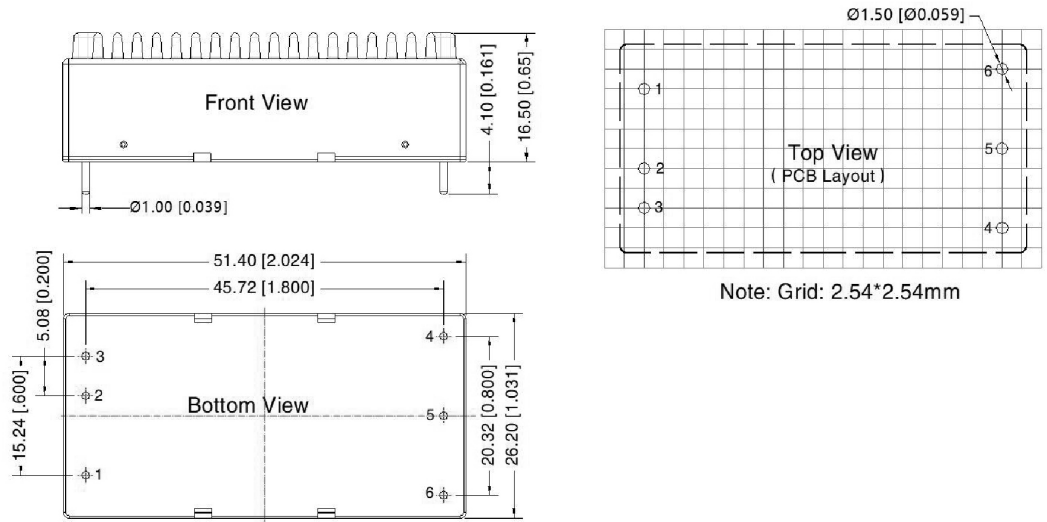

## MECHANICAL DRAWING (CONTINUED)

### CHASSIS MOUNT WITH HEATSINK

units: mm[inch]  
 wire range: 24-12 AWG  
 tightening torque: Max 0.4 N·m  
 general tolerance:  $\pm 1.00[\pm 0.039]$

PIN OUT	
PIN	Function
1	CTRL
2	GND
3	Vin
4	+Vo
5	0V
6	Trim

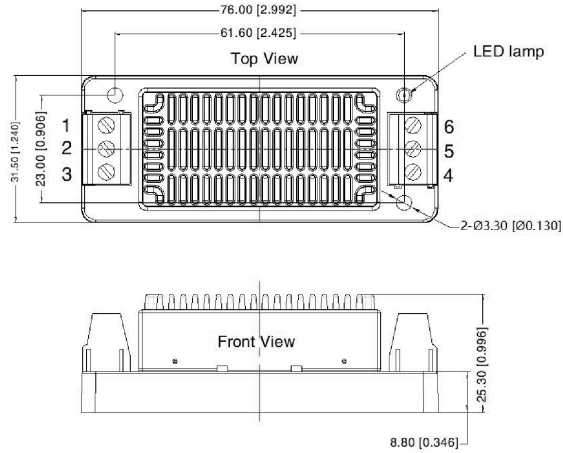

### DIN-RAIL MOUNT WITH HEATSINK

units: mm[inch]  
 mounting rail: TS35  
 wire range: 24-12 AWG  
 tightening torque: Max 0.4 N·m  
 general tolerance:  $\pm 1.00[\pm 0.039]$

PIN OUT	
PIN	Function
1	CTRL
2	GND
3	Vin
4	+Vo
5	0V
6	Trim

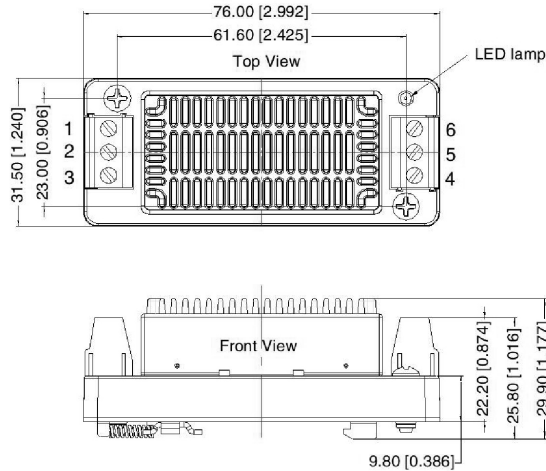

## DERATING CURVES

**TEMPERATURE DERATING CURVE**  
*without heatsink*

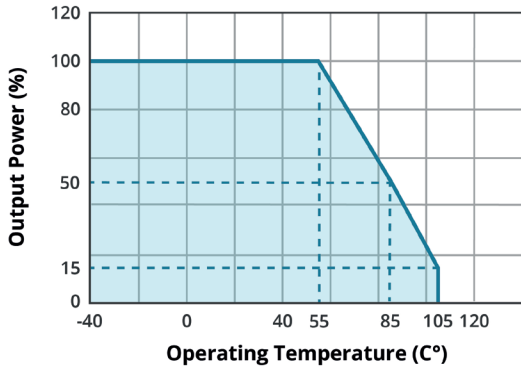

**Key**

- PQAE50-D24-S3
- PQAE50-D24-S5
- PQAE50-D24-S12
- PQAE50-D24-S15
- PQAE50-D24-S24

**TEMPERATURE DERATING CURVE**  
*with heatsink*

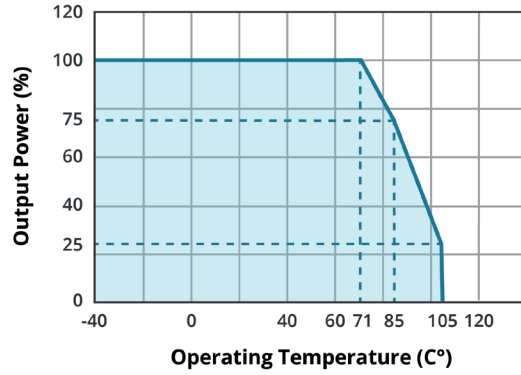

**Key**

- PQAE50-D24-S3-H
- PQAE50-D24-S5-H
- PQAE50-D24-S12-H
- PQAE50-D24-S15-H
- PQAE50-D24-S24-H

**TEMPERATURE DERATING CURVE**  
*without heatsink*

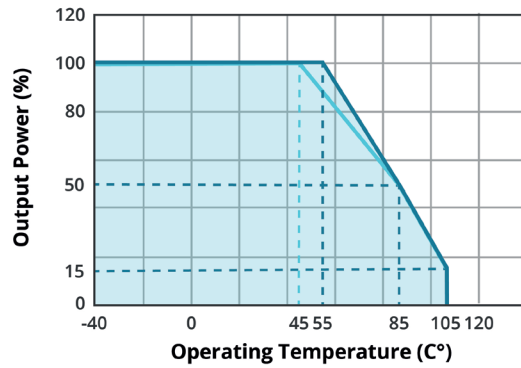

**Key**

- PQAE50-D48-S3
- PQAE50-D48-S5
- PQAE50-D48-S12
- PQAE50-D48-S15
- PQAE50-D48-S24

**TEMPERATURE DERATING CURVE**  
*with heatsink*

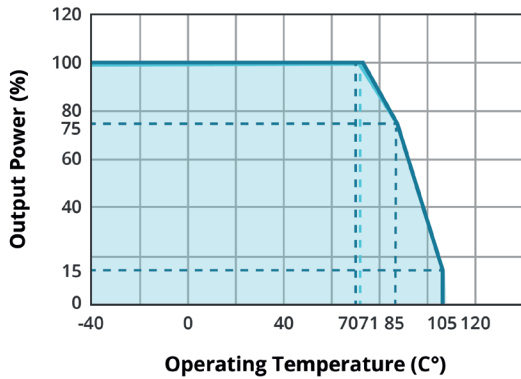

**Key**

- PQAE50-D48-S3-H
- PQAE50-D48-S5-H
- PQAE50-D48-S12-H
- PQAE50-D48-S15-H
- PQAE50-D48-S24-H

## APPLICATION DESIGN REFERENCE

If you want to further reduce the input and output ripple, a filter capacitor may be connected to the input and output terminals (Figure 1) provided that the capacitance is less than the maximum capacitive load of the model, otherwise start-up problems may be caused if the capacitance is too large.

**Figure 1**

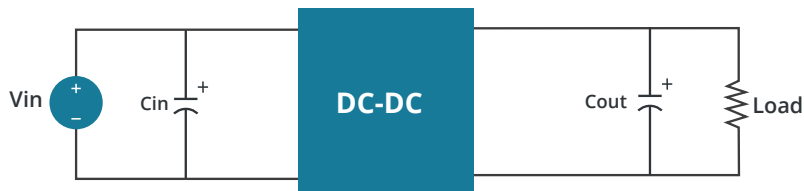
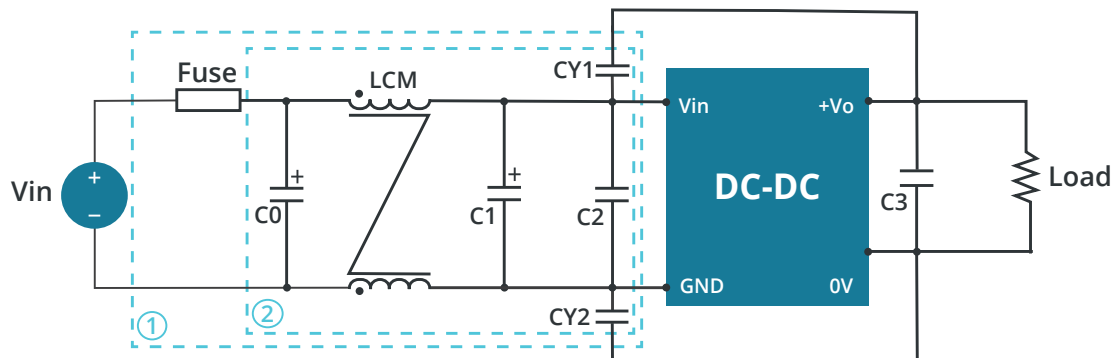

**Table 1**

Vin (Vdc)	Vout (Vdc)	Cin (μF)	Cout (μF)
24/48	3.3	100μF	470μF/10V
	5		470μF/10V
	12		100μF/25V
	15		100μF/25V
	24		47μF/50V

## EMC RECOMMENDED CIRCUIT

**Figure 2**



**Table 2**

MODEL	Vin: 24V	Vin: 48V
FUSE	T/4A/250Vac	T/2A/250Vac
C0	680μF/50V	330μF/100V
LCM	2.2mH	2.2mH
C1	330μF/50V	330μF/100V
C2	4.7μF/50V	2.2μF/100V
CY1, CY2	Y1 Safety capacitor 2.2nF/250Vac	Y1 Safety capacitor 3.3nF/250Vac
C3	refer to Cout in Table 1	refer to Cout in Table 1



## APPLICATION DESIGN REFERENCE (CONTINUED)

### TRIM FUNCTION FOR OUTPUT VOLTAGE ADJUSTMENT (OPEN IF UNUSED)

Figure 3

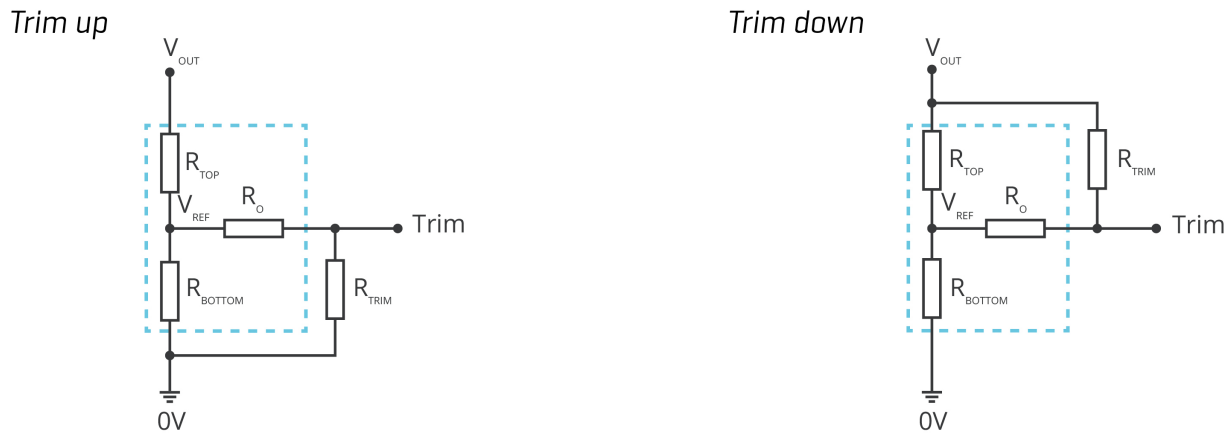

$$R_{TRIM} = \frac{a \cdot R_{BOTTOM}}{R_{BOTTOM} - a} - R_O \quad a = \frac{V_{REF}}{V_{OUT} - V_{REF}} \cdot R_{TOP}$$

Formula for Trim up

$$R_{TRIM} = \frac{a \cdot R_{TOP}}{R_{TOP} - a} - R_O \quad a = \frac{V_{OUT} - V_{REF}}{V_{REF}} \cdot R_{BOTTOM}$$

Formula for Trim down

Note: Trim resistor connection (dashed line shows internal resistor network).

Table 3

Model number	Vout adjustable value (V)	RT (KΩ)	R1 (KΩ)	R2 (KΩ)	R3 (KΩ)	Vref (V)
PQAE50-D24-S3	Up: 3.63 Down: 2.97	15.0 18.7	4.83 4.83	2.87 2.87	4.7 4.7	1.24 1.24
PQAE50-D24-S5	Up: 5.5 Down: 4.5	13.3 5.4	2.97 2.97	2.87 2.87	4.7 4.7	2.5 2.5
PQAE50-D24-S12	Up: 13.2 Down: 10.8	7.6 60.7	10.90 10.90	2.87 2.87	15 15	2.5 2.5
PQAE50-D24-S15	Up: 16.5 Down: 13.5	8.9 90.2	14.35 14.35	2.87 2.87	15 15	2.5 2.5
PQAE50-D24-S24	Up: 26.4 Down: 21.6	21.6 185.9	24.77 24.77	2.87 2.87	5.1 5.1	2.5 2.5
PQAE50-D48-S3	Up: 3.63 Down: 2.97	10 13.5	4.83 4.83	2.87 2.87	10 10	1.24 1.24
PQAE50-D48-S5	Up: 5.5 Down: 4.5	4.3 1.5	2.87 2.87	2.87 2.87	10 10	2.5 2.5
PQAE50-D48-S12	Up: 13.2 Down: 10.8	7.6 60.7	10.90 10.90	2.87 2.87	15 15	2.5 2.5
PQAE50-D48-S15	Up: 16.5 Down: 13.5	8.9 90.2	14.35 14.35	2.87 2.87	15 15	2.5 2.5
PQAE50-D48-S24	Up: 26.4 Down: 21.6	21.6 185.9	48.77 48.77	2.87 2.87	5.1 5.1	2.5 2.5

Note: Value for  $R_{TOP}$ ,  $R_{BOTTOM}$ ,  $R_O$ , and  $V_{REF}$  refer to Table 3 (fixed internal values).

$R_{TRIM}$ : Trim resistance

a: User-defined parameter, no actual meanings

$V_{OUT}$ : Nominal output voltage

## REVISION HISTORY

rev.	description	date
1.0	initial release	11/16/2020
1.01	part number key updated	12/14/2020
1.02	mechanical drawings updated	01/12/2021
1.03	datasheet updated	07/29/2021
1.04	updated notes in model table	10/01/2021
1.05	application design reference section updated	02/24/2022
1.06	protections updated, application design reference section updated	07/22/2022
1.07	U-frame option added, CE certification updated for 24V models	10/24/2022
1.08	PN key updated	03/01/2023

The revision history provided is for informational purposes only and is believed to be accurate.



**CUI INC**

a bel group

**Headquarters**  
20050 SW 112th Ave.  
Tualatin, OR 97062  
**800.275.4899**

Fax 503.612.2383  
**cui.com**  
techsupport@cui.com

CUI offers a two (2) year limited warranty. Complete warranty information is listed on our website.

CUI reserves the right to make changes to the product at any time without notice. Information provided by CUI is believed to be accurate and reliable. However, no responsibility is assumed by CUI for its use, nor for any infringements of patents or other rights of third parties which may result from its use.

CUI products are not authorized or warranted for use as critical components in equipment that requires an extremely high level of reliability. A critical component is any component of a life support device or system whose failure to perform can be reasonably expected to cause the failure of the life support device or system, or to affect its safety or effectiveness.