

**ISOTOP[®] Boost chopper
Trench + Field Stop IGBT3**

**V_{CES} = 1200V
I_C = 35A @ T_c = 80°C**

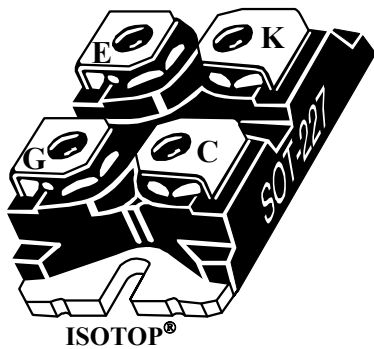
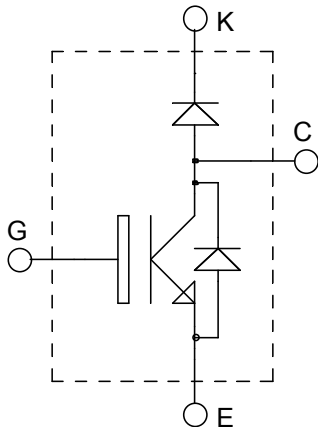

Application

- AC and DC motor control
- Switched Mode Power Supplies
- Power Factor Correction
- Brake switch

Features

- Trench + Field Stop IGBT3 Technology
 - Low voltage drop
 - Low tail current
 - Switching frequency up to 20 kHz
 - Soft recovery parallel diodes
 - Low diode VF
 - Low leakage current
 - RBSOA and SCSOA rated
- ISOTOP[®] Package (SOT-227)
- Very low stray inductance
- High level of integration

Benefits

- Low conduction losses
- Stable temperature behavior
- Very rugged
- Direct mounting to heatsink (isolated package)
- Low junction to case thermal resistance
- Easy paralleling due to positive T_C of V_{CEsat}
- RoHS Compliant

Absolute maximum ratings

Symbol	Parameter	Max ratings	Unit
V _{CES}	Collector - Emitter Breakdown Voltage	1200	V
I _{C1}	Continuous Collector Current	T _C = 25°C	55
I _{C2}		T _C = 80°C	35
I _{CM}	Pulsed Collector Current	T _C = 25°C	80
V _{GE}	Gate - Emitter Voltage	±20	V
P _D	Maximum Power Dissipation	T _C = 25°C	260
IF _{AV}	Maximum Average Forward Current	Duty cycle=0.5	A
IF _{RMS}	RMS Forward Current (Square wave, 50% duty)	T _C = 80°C	
			34

CAUTION: These Devices are sensitive to Electrostatic Discharge. Proper Handling Procedures Should Be Followed.

All ratings @ $T_j = 25^\circ\text{C}$ unless otherwise specified

Electrical Characteristics

<i>Symbol</i>	<i>Characteristic</i>	<i>Test Conditions</i>	<i>Min</i>	<i>Typ</i>	<i>Max</i>	<i>Unit</i>
I_{CES}	Zero Gate Voltage Collector Current	$V_{GE} = 0V, V_{CE} = 1200V$			5	mA
$V_{CE(sat)}$	Collector Emitter saturation Voltage	$V_{GE} = 15V$ $I_C = 35A$	$T_j = 25^\circ\text{C}$ $T_j = 125^\circ\text{C}$	1.4 2.0	1.7 2.1	V
$V_{GE(th)}$	Gate Threshold Voltage	$V_{GE} = V_{CE}, I_C = 3mA$		5.0	6.5	V
I_{GES}	Gate – Emitter Leakage Current	$V_{GE} = \pm 20V, V_{CE} = 0V$			500	nA

Dynamic Characteristics

<i>Symbol</i>	<i>Characteristic</i>	<i>Test Conditions</i>	<i>Min</i>	<i>Typ</i>	<i>Max</i>	<i>Unit</i>
C_{ies}	Input Capacitance	$V_{GE} = 0V$		2530		pF
C_{oes}	Output Capacitance	$V_{CE} = 25V$		132		
C_{res}	Reverse Transfer Capacitance	$f = 1MHz$		115		
$T_{d(on)}$	Turn-on Delay Time	Resistive Switching (25°C)		85		ns
T_r	Rise Time	$V_{GE} = 15V$ $V_{Bus} = 600V$		30		
$T_{d(off)}$	Turn-off Delay Time	$I_C = 35A$		420		
T_f	Fall Time	$R_G = 27\Omega$		62		
$T_{d(on)}$	Turn-on Delay Time	Inductive Switching (125°C)		90		ns
T_r	Rise Time	$V_{GE} = 15V$ $V_{Bus} = 600V$		45		
$T_{d(off)}$	Turn-off Delay Time	$I_C = 35A$		520		
T_f	Fall Time	$R_G = 27\Omega$		90		
E_{on}	Turn-on Switching Energy			5.8		mJ
E_{off}	Turn-off Switching Energy			4.6		

Chopper diode ratings and characteristics

Symbol	Characteristic	Test Conditions	Min	Typ	Max	Unit
V _F	Diode Forward Voltage	I _F = 30A		2.0	2.5	V
		I _F = 60A		2.3		
		I _F = 30A	T _j = 125°C	1.8		
I _{RM}	Maximum Reverse Leakage Current	V _R = 1200V	T _j = 25°C		250	μA
		V _R = 1200V	T _j = 125°C		500	
C _T	Junction Capacitance	V _R = 200V		32		pF
t _{rr}	Reverse Recovery Time	I _F = 1A, V _R = 30V di/dt = 100A/μs	T _j = 25°C	31		ns
	Reverse Recovery Time		T _j = 25°C	370		
			T _j = 125°C	500		
I _{RRM}	Maximum Reverse Recovery Current	I _F = 30A V _R = 800V di/dt = 200A/μs	T _j = 25°C	5		A
			T _j = 125°C	12		
			T _j = 25°C	660		
Q _{rr}	Reverse Recovery Charge		T _j = 25°C	3450		nC
			T _j = 125°C			
t _{rr}	Reverse Recovery Time	I _F = 30A	T _j = 125°C	220		ns
Q _{rr}	Reverse Recovery Charge	V _R = 800V		4650		nC
I _{RRM}	Maximum Reverse Recovery Current	di/dt = 1000A/μs		37		A

Thermal and package characteristics

Symbol	Characteristic	Min	Typ	Max	Unit
R _{thJC}	Junction to Case Thermal Resistance	IGBT		0.48	°C/W
		Diode		1.1	
R _{thJA}	Junction to Ambient (IGBT & Diode)			20	
V _{ISOL}	RMS Isolation Voltage, any terminal to case t = 1 min, 50/60Hz	2500			V
T _J , T _{STG}	Storage Temperature Range	-55		150	°C
T _L	Max Lead Temp for Soldering: 0.063" from case for 10 sec			300	
Torque	Mounting torque (Mounting = 8-32 or 4mm Machine and terminals = 4mm Machine)			1.5	N.m
Wt	Package Weight		29.2		g

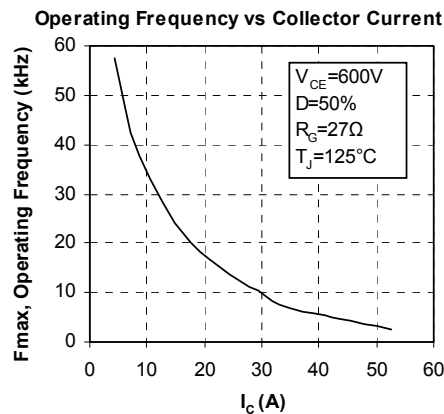
Typical IGBT Performance Curve

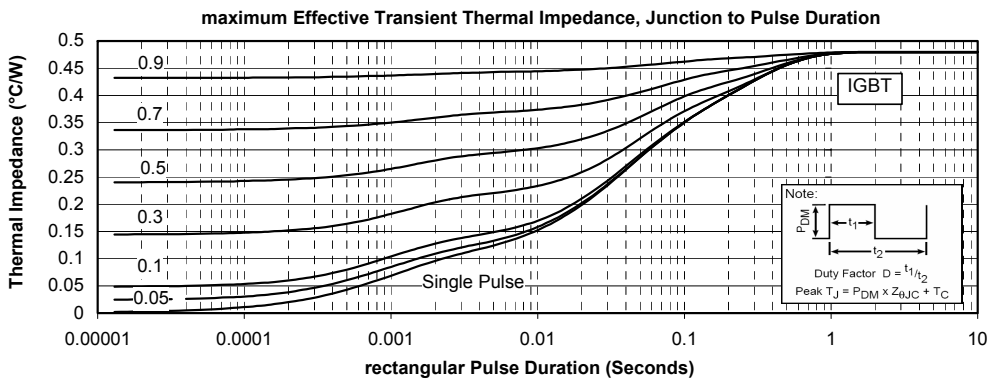
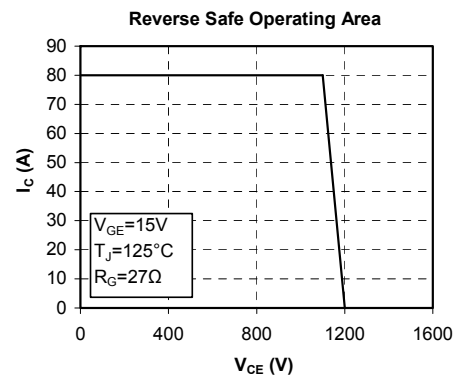
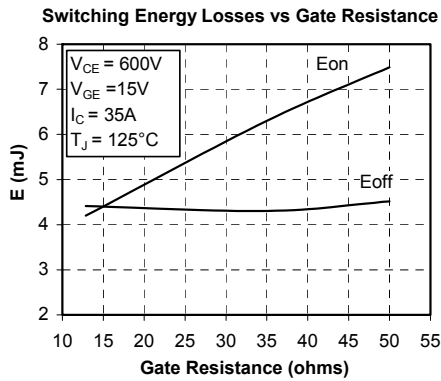
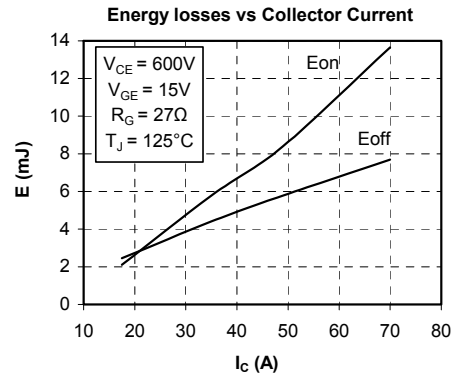
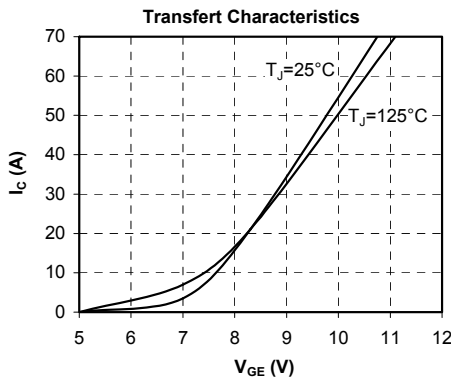
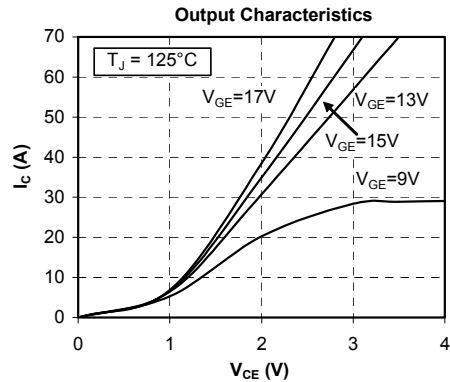
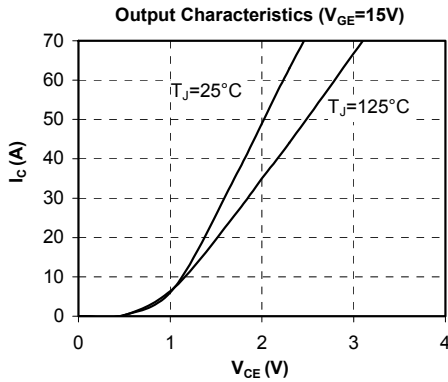

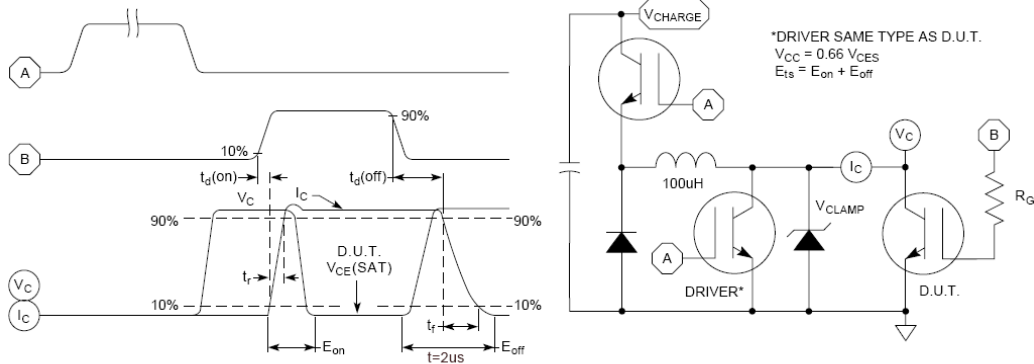

Figure 15, Switching Loss Test Circuit and Waveforms

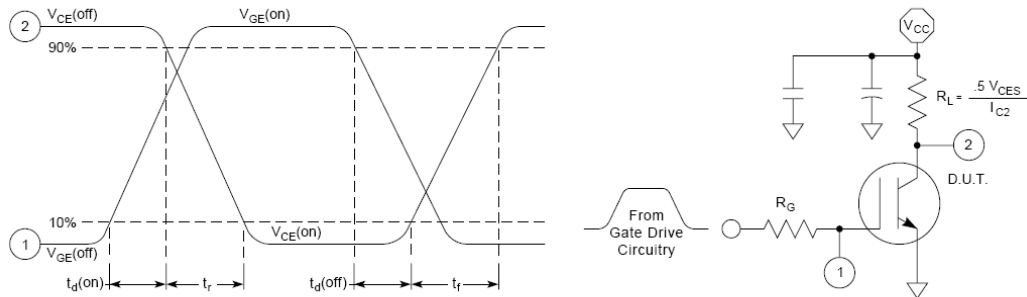

Figure 16, Resistive Switching Time Test Circuit and Waveforms

Typical Diode Performance Curve

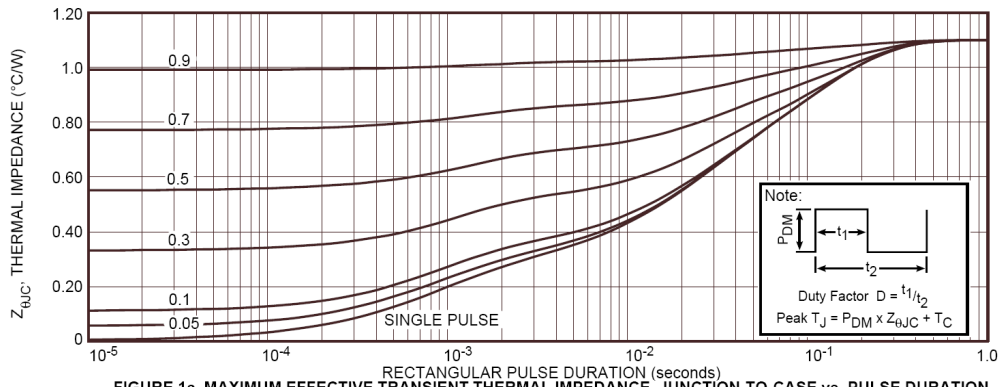

FIGURE 1a. MAXIMUM EFFECTIVE TRANSIENT THERMAL IMPEDANCE, JUNCTION-TO-CASE vs. PULSE DURATION

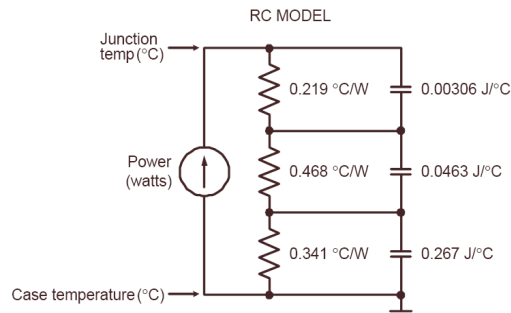

FIGURE 1b, TRANSIENT THERMAL IMPEDANCE MODEL

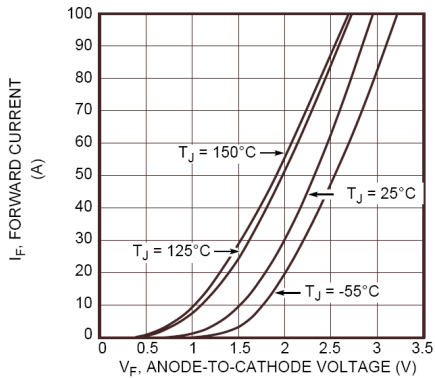

Figure 2. Forward Current vs. Forward Voltage

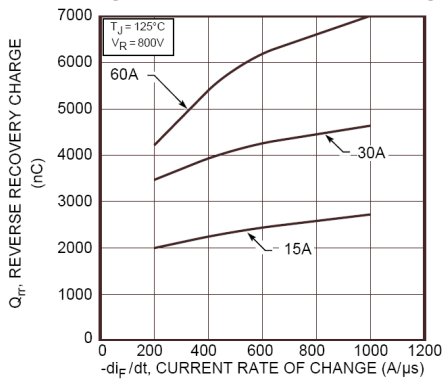

Figure 4. Reverse Recovery Charge vs. Current Rate of Change

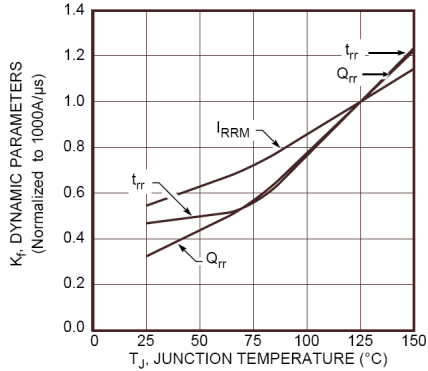

Figure 6. Dynamic Parameters vs. Junction Temperature

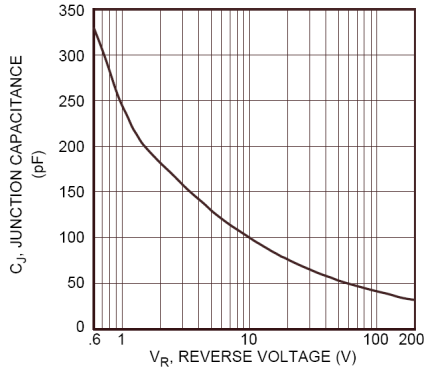

Figure 8. Junction Capacitance vs. Reverse Voltage

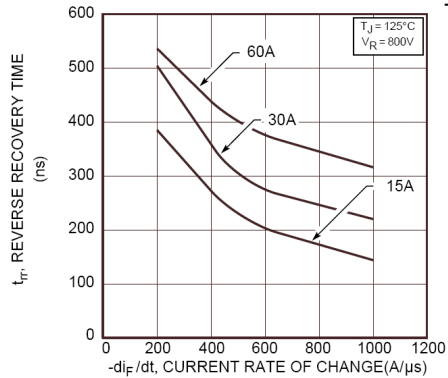

Figure 3. Reverse Recovery Time vs. Current Rate of Change

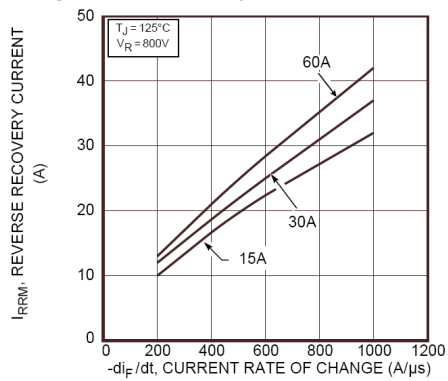

Figure 5. Reverse Recovery Current vs. Current Rate of Change

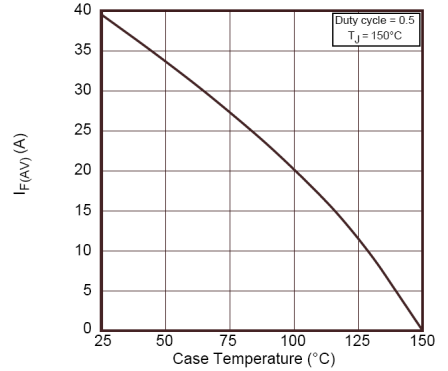

Figure 7. Maximum Average Forward Current vs. Case Temperature

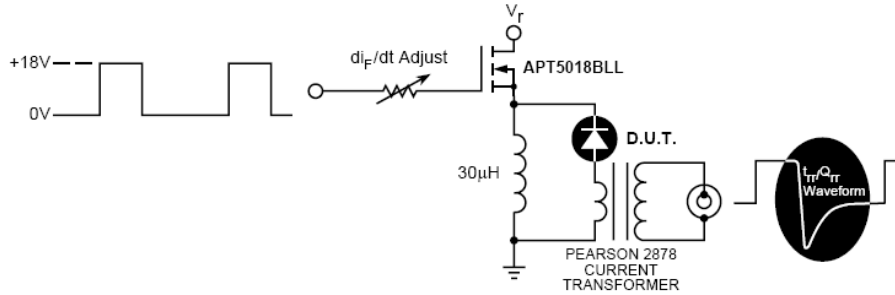

Figure 9. Diode Test Circuit

- 1 I_F - Forward Conduction Current
- 2 di_F/dt - Rate of Diode Current Change Through Zero Crossing.
- 3 I_{RRM} - Maximum Reverse Recovery Current.
- 4 t_{rr} - Reverse Recovery Time, measured from zero crossing where diode current goes from positive to negative, to the point at which the straight line through I_{RRM} and $0.25 \cdot I_{RRM}$ passes through zero.
- 5 Q_{rr} - Area Under the Curve Defined by I_{RRM} and t_{rr} .

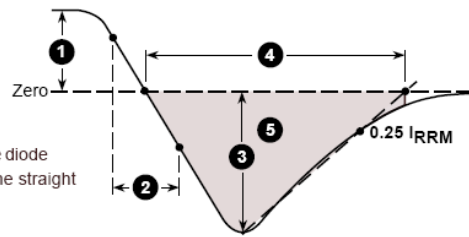
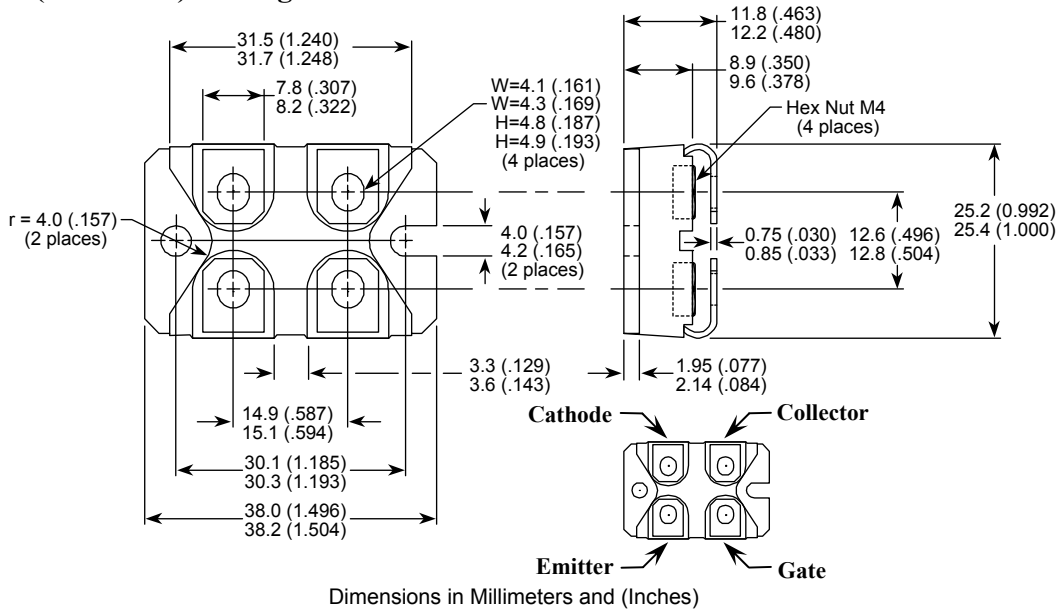

Figure 10. Diode Reverse Recovery Waveform and Definitions

SOT-227 (ISOTOP[®]) Package Outline



ISOTOP[®] is a registered trademark of ST Microelectronics NV

DISCLAIMER

The information contained in the document (unless it is publicly available on the Web without access restrictions) is PROPRIETARY AND CONFIDENTIAL information of Microsemi and cannot be copied, published, uploaded, posted, transmitted, distributed or disclosed or used without the express duly signed written consent of Microsemi. If the recipient of this document has entered into a disclosure agreement with Microsemi, then the terms of such Agreement will also apply. This document and the information contained herein may not be modified, by any person other than authorized personnel of Microsemi. No license under any patent, copyright, trade secret or other intellectual property right is granted to or conferred upon you by disclosure or delivery of the information, either expressly, by implication, inducement, estoppels or otherwise. Any license under such intellectual property rights must be approved by Microsemi in writing signed by an officer of Microsemi.

Microsemi reserves the right to change the configuration, functionality and performance of its products at anytime without any notice. This product has been subject to limited testing and should not be used in conjunction with life-support or other mission-critical equipment or applications. Microsemi assumes no liability whatsoever, and Microsemi disclaims any express or implied warranty, relating to sale and/or use of Microsemi products including liability or warranties relating to fitness for a particular purpose, merchantability, or infringement of any patent, copyright or other intellectual property right. Any performance specifications believed to be reliable but are not verified and customer or user must conduct and complete all performance and other testing of this product as well as any user or customers final application. User or customer shall not rely on any data and performance specifications or parameters provided by Microsemi. It is the customer's and user's responsibility to independently determine suitability of any Microsemi product and to test and verify the same. The information contained herein is provided "AS IS, WHERE IS" and with all faults, and the entire risk associated with such information is entirely with the User. Microsemi specifically disclaims any liability of any kind including for consequential, incidental and punitive damages as well as lost profit. The product is subject to other terms and conditions which can be located on the web at <http://www.microsemi.com/legal/tnc.asp>

Life Support Application

Seller's Products are not designed, intended, or authorized for use as components in systems intended for space, aviation, surgical implant into the body, in other applications intended to support or sustain life, or for any other application in which the failure of the Seller's Product could create a situation where personal injury, death or property damage or loss may occur (collectively "Life Support Applications").

Buyer agrees not to use Products in any Life Support Applications and to the extent it does it shall conduct extensive testing of the Product in such applications and further agrees to indemnify and hold Seller, and its officers, employees, subsidiaries, affiliates, agents, sales representatives and distributors harmless against all claims, costs, damages and expenses, and attorneys' fees and costs arising, directly or indirectly, out of any claims of personal injury, death, damage or otherwise associated with the use of the goods in Life Support Applications, even if such claim includes allegations that Seller was negligent regarding the design or manufacture of the goods.

Buyer must notify Seller in writing before using Seller's Products in Life Support Applications. Seller will study with Buyer alternative solutions to meet Buyer application specification based on Sellers sales conditions applicable for the new proposed specific part.