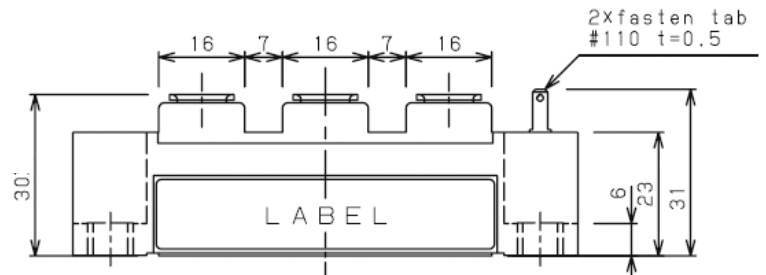
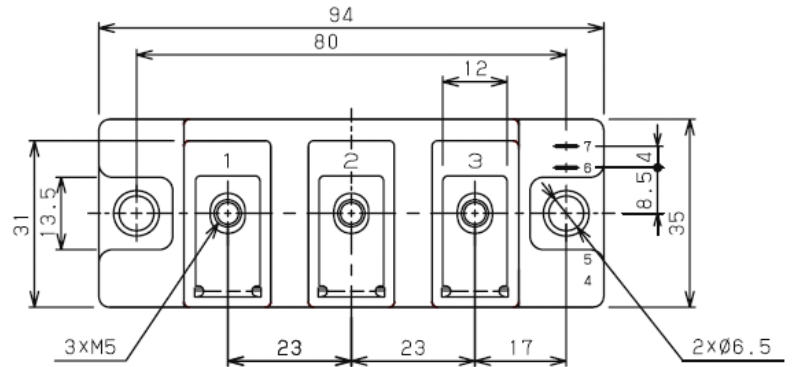
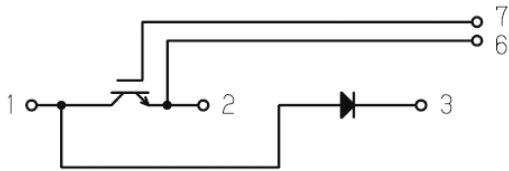

□ 回路図 : *CIRCUIT*

 □ 概略図 : *SCHEMATIC DIAGRAM*

Dimension: [mm]

 □ 最大定格 : *MAXIMUM RATINGS* (at $T_c=25^\circ\text{C}$ unless otherwise specified)

Item		Symbol	Condition	Rated Value	Unit
IGBT	コレクタ・エミッタ間電圧 Collector-Emitter Voltage	V_{CES}	G-E Short	650	V
	ゲート・エミッタ間電圧 Gate-Emitter Voltage	V_{GES}	C-E Short	± 20	V
	コレクタ電流 Collector Current	I_C	DC $T_c=85^\circ\text{C}$	200	A
		I_{CP}	Pulse $\leq 1\text{ms}$	400	
コレクタ損失 Collector Power Dissipation	P_C	$T_j=175^\circ\text{C}$	714	W	
		$T_j=150^\circ\text{C}$	595		
FWD	繰り返しピーク逆電圧 Repetitive peak reverse voltage	V_{RRM}		650	V
	順電流 Forward Current	I_F		200	A
		I_{FM}	Pulse $\leq 1\text{ms}$	400	
最大接合温度 Maximum Junction Temperature		T_{jMAX}	瞬時動作(過負荷) Instantaneous Overload	175	$^\circ\text{C}$
接合温度範囲 Junction Temperature Range		T_j		$-40 \sim +150$	$^\circ\text{C}$
保存温度範囲 Storage Temperature Range		T_{stg}		$-40 \sim +125$	$^\circ\text{C}$
絶縁耐圧 Isolation Voltage		V_{ISO}	Terminal to Base AC, 1minute	2,500	V (RMS)
締め付けトルク Mounting Torque	Module Base to Heatsink	F_{tor}	M6	3	N · m
	Busbar to Main Terminal		M5	2	

□ 電気的特性 : **ELECTRICAL CHARACTERISTICS** (at $T_J=25^\circ\text{C}$ unless otherwise specified)

Characteristic		Symbol	Test Condition	Min.	Typ.	Max.	Unit		
IGBT	コレクタ遮断電流 Collector-Emitter Cut-Off Current	ICES	$V_{CE}=650\text{V}, V_{GE}=0\text{V}$	—	—	1.0	mA		
	ゲート漏れ電流 Gate-Emitter Leakage Current	IGES	$V_{GE}=\pm 20\text{V}, V_{CE}=0\text{V}$	—	—	1.0	μA		
	コレクタ・エミッタ間飽和電圧 Collector-Emitter Saturation Voltage	$V_{CE(sat.)}$	$I_C=200\text{A}, V_{GE}=15\text{V}$ (chip level)	$T_J=25^\circ\text{C}$ $T_J=125^\circ\text{C}$ $T_J=150^\circ\text{C}$	— — —	1.45 1.65 1.70	1.95 — —	V	
	ゲートしきい値電圧 Gate-Emitter Threshold Voltage	$V_{GE(th.)}$	$V_{CE}=10\text{V}, I_C=4\text{mA}$		4.8	—	7.0	V	
	入力容量 Input Capacitance	Cies	$V_{CE}=25\text{V}, V_{GE}=0\text{V}, f=1\text{MHz}$		—	17.0	—	nF	
	出力容量 Output Capacitance	Coes			—	0.7	—		
	帰還容量 Reverse Transfer Capacitance	Cres			—	0.6	—		
	ゲート電荷量 Gate Charge	Qg	$V_{CC}=300\text{V}, I_C=200\text{A}, V_{GE}=-15\sim+15\text{V}$		—	1700	—	nC	
	スイッチング時間 Switching Time	上昇時間 Rise Time	tr	$V_{CC}=300\text{V}$ $L_s=38\text{nH}$ $I_C=200\text{A}$ Inductive Load		—	66	—	ns
		ターンオン遅延時間 Turn-on Delay Time	td(on)	$R_G=3.6\Omega$		—	110	—	
下降時間 Fall Time		tf	$V_{GE}=\pm 15\text{V}$		—	68	—		
ターンオフ遅延時間 Turn-off Delay Time		td(off)	$T_J=150^\circ\text{C}$		—	290	—		
FWD	順電圧 Peak Forward Voltage	V_F	$I_F=200\text{A}, V_{GE}=0\text{V}$ (chip level)	$T_J=25^\circ\text{C}$ $T_J=125^\circ\text{C}$ $T_J=150^\circ\text{C}$	— — —	1.70 1.60 1.55	2.20 — —	V	
	逆回復時間 Reverse Recovery Time	t _{rr}	$V_{CC}=300\text{V}$ $L_s=38\text{nH}$ $I_C=200\text{A}$ Inductive Load $R_G=3.6\Omega$ $V_{GE}=\pm 15\text{V}$ $T_J=150^\circ\text{C}$		—	145	—	ns	
内部配線抵抗 Internal Lead Resistance		RCC+EE'	主端子—チップ間 / 1素子 Main Terminal - Chip / Per 1 Arm		—	—	1	m Ω	
内部インダクタンス Stray Inductance		LSCE	メイン端子3—2間 Main Terminal3 - Main Terminal2		—	30	—	nH	

 □ 熱的特性 : **THERMAL CHARACTERISTICS**

Characteristic		Symbol	Test Condition	Min.	Typ.	Max.	Unit
熱抵抗 Thermal Resistance	IGBT	Rth(j-c)	Junction to Case Per 1 Arm (Tc測定点:チップ直下)	—	—	0.21	$^\circ\text{C}/\text{W}$
	FWD			—	—	0.48	
接触熱抵抗 Thermal Resistance	IGBT	Rth(c-f)	Case to heatsink Per 1 Arm Paste=1W/(m 2 °C)	—	0.10	—	
	FWD			—	0.17	—	

特性图 : CHARACTERISTICS CURVES

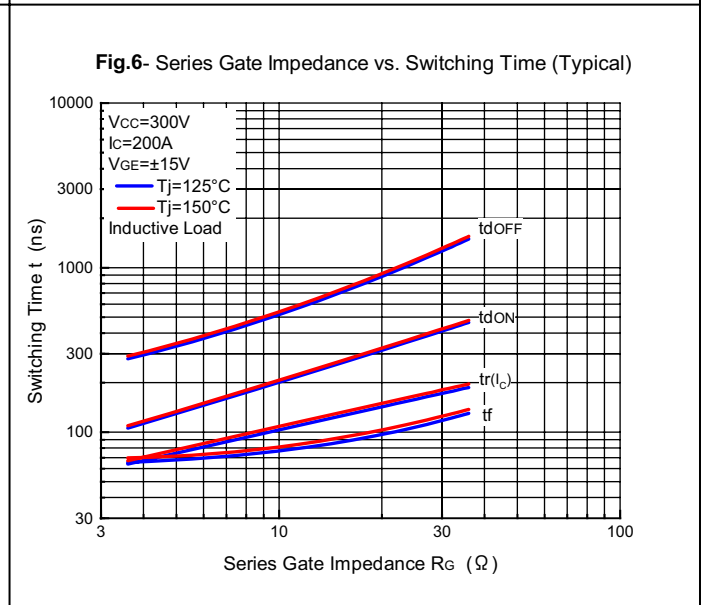
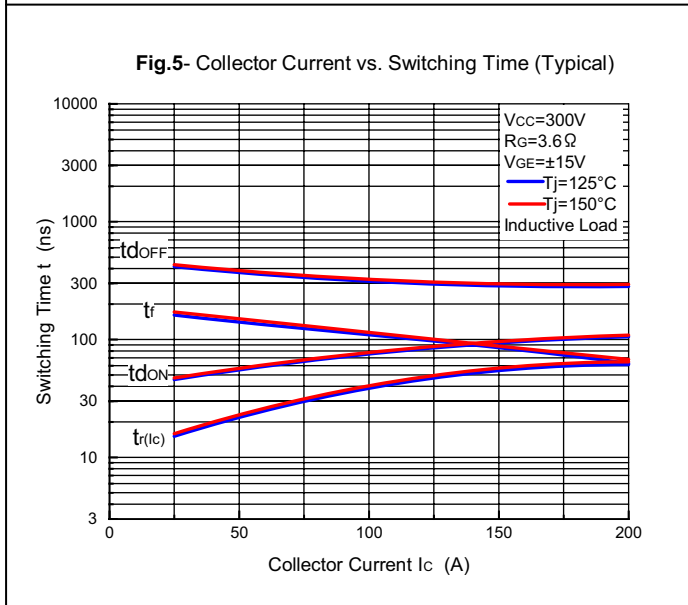
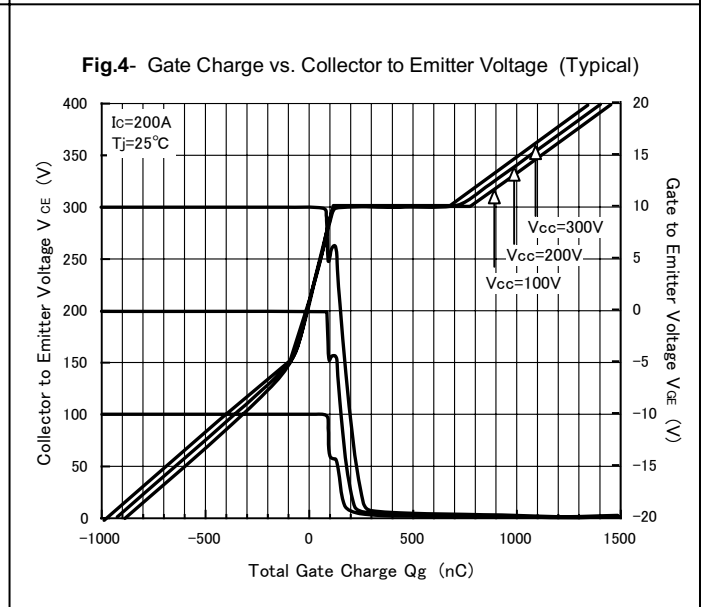
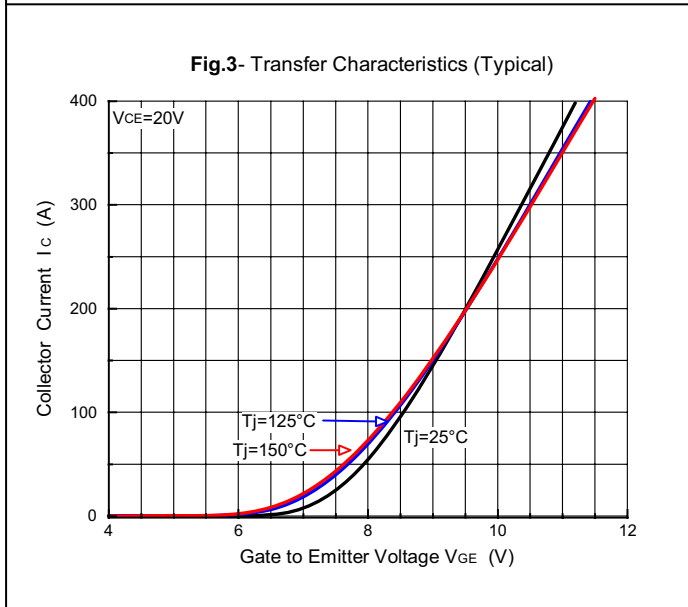
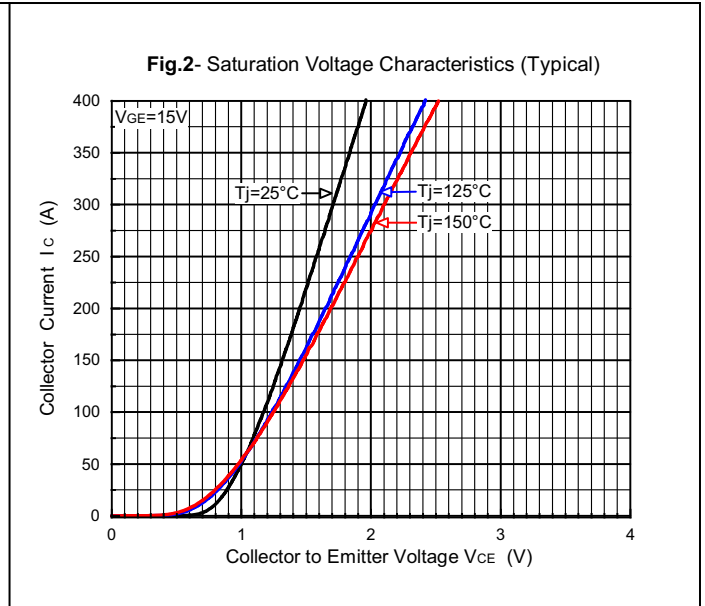
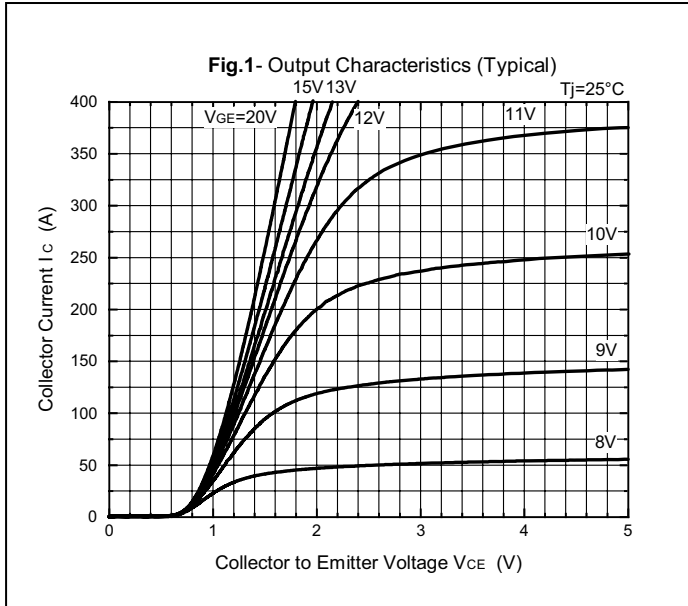

特性 : CHARACTERISTICS CURVES

