

## Han HsB-SMC-MC-CRT-10 mm<sup>2</sup> / 8 AWG-Ag

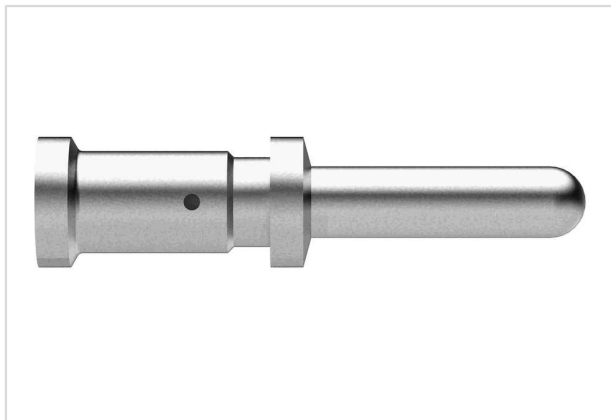

Image is for illustration purposes only. Please refer to product description.

Part number	09 31 000 6103
Specification	Han HsB-SMC-MC-CRT-10 mm <sup>2</sup> / 8 AWG-Ag
HARTING eCatalogue	<a href="https://b2b.harting.com/09310006103">https://b2b.harting.com/09310006103</a>

### Identification

Category	Contacts
Series	Han <sup>®</sup> HsB
Type of contact	Crimp contact

### Version

Gender	Male
Manufacturing process	Turned contacts

### Technical characteristics

Conductor cross-section	10 mm <sup>2</sup>
Conductor cross-section	AWG 8
Rated current	≤35 A
Contact resistance	≤1 mΩ
Stripping length	9.5 mm

### Material properties

Material (contacts)	Copper alloy
Surface (contacts)	Silver plated
RoHS	compliant with exemption
RoHS exemptions	6(c): Copper alloy containing up to 4 % lead by weight
ELV status	compliant with exemption
China RoHS	50
REACH Annex XVII substances	Not contained



**Pushing Performance**  
Since 1945

## Material properties

REACH ANNEX XIV substances	Not contained
REACH SVHC substances	Yes
REACH SVHC substances	Lead
California Proposition 65 substances	Yes
California Proposition 65 substances	Lead

## Specifications and approvals

Specifications	IEC 60664-1
	IEC 61984

## Commercial data

Packaging size	25
Net weight	2.7 g
Country of origin	Germany
European customs tariff number	85366990
GTIN	5713140188013
ETIM	EC000796
eCl@ss	27440204 Contact for industrial connectors