

**MHS 5/07 W T3 B T****Weidmüller Interface GmbH & Co. KG**

Klingenbergstraße 26

D-32758 Detmold

Germany

www.weidmueller.com

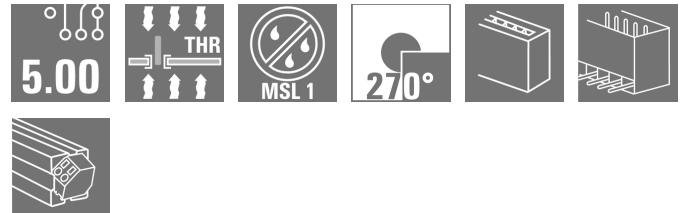
**Product image****OMNIMATE® 4.0 - the next evolution step**

OMNIMATE® 4.0 follows the trend of One Cable Technology (OCT). The modular concept enables the fast configuration of hybrid interfaces, which transmit data, signals and energy in a single connector. As a result, you can reduce the cabling effort in a wide variety of applications, simplify maintenance and accelerate automation processes. The unique SNAP IN connection is the backbone and speeds up the wiring process.

**The fastest connection yet**

- Fast, safe, and tool-free wiring due to unique SNAP IN connection
- Ready for Robot through "wire ready" delivery with open clamping point
- Optical and acoustic feedback indicates proper wiring

**Create your own configuration**

- Flexible configuration and ordering via the Weidmüller Configurator (WMC)
- Dispatch within three days – even for individually configured products
- Automatic offer preparation for the configured product

**Simply configuration of modular hybrid connectors**

- Flexible combination options for power, signal and data transmission
- Future-proof Single-Pair Ethernet technology

**General ordering data**

Version	PCB plug-in connector, male header, THT/THR solder connection, Pitch in mm (P): 5.00 mm, Number of poles: 7, 270°, Tube
Order No.	<a href="#">8000072510</a>
Type	MHS 5/07 W T3 B T
GTIN (EAN)	4064675330585
Qty.	15 pc(s).
Product data	IEC: 400 V / 26.8 A UL: 300 V / 18.5 A
Packaging	Tube

Creation date June 6, 2024 12:40:42 AM CEST

Catalogue status 01.06.2024 / We reserve the right to make technical changes.

## MHS 5/07 W T3 B T

Weidmüller Interface GmbH &amp; Co. KG

Klingenbergstraße 26

D-32758 Detmold

Germany

www.weidmueller.com

## Technical data

## Dimensions and weights

Depth	14 mm	Depth (inches)	0.551 inch
Height	14.1 mm	Height (inches)	0.555 inch
Height of lowest version	10.9 mm	Width	36.38 mm
Width (inches)	1.432 inch	Net weight	5.601 g

## System specifications

Product family	OMNIMATE 4.0	Type of connection	Board connection
Mounting onto the PCB	THT/THR solder connection	Pitch in mm (P)	5 mm
Pitch in inches (P)	0.197 "	Outgoing elbow	270°
Number of poles	7	Number of solder pins per pole	1
Solder pin length (l)	3.2 mm	Solder pin dimensions	1.0 x 1.0 mm
Solder eyelet hole diameter (D)	1.4 mm	Solder eyelet hole diameter tolerance (D)+	0,1 mm
Outside diameter of solder pad	2.3 mm	Template aperture diameter	2.1 mm
L1 in mm	30 mm	L1 in inches	1.181 "
Number of rows	1	Pin series quantity	1
Touch-safe protection acc. to DIN VDE 57 106	Touch-safe above the printed circuit board	Touch-safe protection acc. to DIN VDE 0470	IP 20
Protection degree	IP20	Volume resistance	≤5 mΩ
Plugging cycles	≥ 25	Plugging force/pole, max.	8.5 N
Pulling force/pole, max.	8.5 N		

## Material data

Insulating material	PA 9T	Colour	black
Colour chart (similar)	RAL 9011	Insulating material group	I
Comparative Tracking Index (CTI)	≥ 600	Moisture Level (MSL)	1
UL 94 flammability rating	V-0	Contact base material	CuMg
Contact material	Cu-alloy	Contact surface	tinned
Tinning type	matt	Storage temperature, min.	-25 °C
Storage temperature, max.	55 °C	Operating temperature, min.	-50 °C
Operating temperature, max.	100 °C		

## Rated data acc. to IEC

tested acc. to standard	IEC 60664-1, IEC 61984	Rated current, min. number of poles (Tu=20°C)	26.8 A
Rated current, max. number of poles (Tu=20°C)	19.7 A	Rated current, min. number of poles (Tu=40°C)	23.1 A
Rated current, max. number of poles (Tu=40°C)	16.9 A	Rated voltage for surge voltage class / pollution degree II/2	400 V
Rated voltage for surge voltage class / pollution degree III/2	320 V	Rated voltage for surge voltage class / pollution degree III/3	250 V
Rated impulse voltage for surge voltage class/ pollution degree II/2	4 kV	Rated impulse voltage for surge voltage class/ pollution degree III/2	4 kV
Rated impulse voltage for surge voltage class/ contamination degree III/3	4 kV	Clearance, min.	4 mm
Creepage distance, min.	5.4 mm		

**Data sheet**

**MHS 5/07 W T3 B T**

**Weidmüller Interface GmbH & Co. KG**  
 Klingenbergstraße 26  
 D-32758 Detmold  
 Germany

www.weidmueller.com

**Technical data**

**Rated data acc. to UL 1059**

Institute (cURus)



Certificate No. (cURus)

E60693

Rated voltage (Use group B / UL 1059)	300 V	Rated voltage (Use group D / UL 1059)	300 V
Rated voltage (Use group F / UL 1059)	420 V	Rated current (Use group B / UL 1059)	18.5 A
Rated current (Use group D / UL 1059)	10 A	Clearance distance, min.	4 mm
Creepage distance, min.	5.6 mm	Reference to approval values	Specifications are maximum values, details - see approval certificate.

**Classifications**

ETIM 6.0	EC002637	ETIM 7.0	EC002637
ETIM 8.0	EC002637	ETIM 9.0	EC002637
ECLASS 9.0	27-44-04-02	ECLASS 9.1	27-44-04-02
ECLASS 10.0	27-44-04-02	ECLASS 11.0	27-46-02-01
ECLASS 12.0	27-46-02-01	ECLASS 13.0	27-46-02-01

**Important note**

IPC conformity	Conformity: The products are developed, manufactured and delivered according international recognized standards and norms and comply with the assured properties in the data sheet resp. fulfill decorative properties in accordance with IPC-A-610 "Class 2". Further claims on the products can be evaluated on request.
Notes	<ul style="list-style-type: none"> <li>• Rated current related to rated cross-section &amp; min. No. of poles.</li> <li>• P on drawing = pitch</li> <li>• Rated data refer only to the component itself. Clearance and creepage distances to other components are to be designed in accordance with the relevant application standards.</li> <li>• Diameter of solder eyelet D = 1.4+0.1mm</li> <li>• In accordance with IEC 61984, OMNIMATE-connectors are connectors without breaking capacity (COC). During designated use, connectors are not allowed to be engaged or disengaged when live or under load</li> <li>• Long term storage of the product with average temperature of 50 °C and maximum humidity 70%, 36 months</li> </ul>

**Approvals**

Approvals



UL File Number Search	UL Website
Certificate No. (cURus)	E60693

**Downloads**

Approval/Certificate/Document of Conformity	<a href="#">CoC_cURus_E60693_MPS_MHS_202207.pdf</a> <a href="#">Declaration of the Manufacturer</a>
Engineering Data	<a href="#">CAD data – STEP</a>
Catalogues	<a href="#">Catalogues in PDF-format</a>

Creation date June 6, 2024 12:40:42 AM CEST

Catalogue status 01.06.2024 / We reserve the right to make technical changes.

MHS 5/07 W T3 B T

Weidmüller Interface GmbH & Co. KG  
Klingenbergstraße 26  
D-32758 Detmold  
Germany

[www.weidmueller.com](http://www.weidmueller.com)

Drawings

Product image



Dimensional drawing

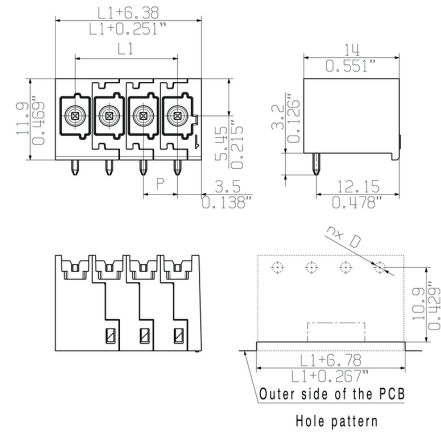

Allgemeinguetlige Kundenzeichnung, aktueller Stand nur auf Anfrage  
 General customer drawing, topical version only if required

The reproduction, distribution and utilization of this document as well as the communication of its contents to others without explicit authorization is prohibited. Offenders will be held liable for the payment of damages. Weidmueller exclusively reserves the right to file for patents, utility models or designs.

© Weidmueller Interface GmbH & Co. KG

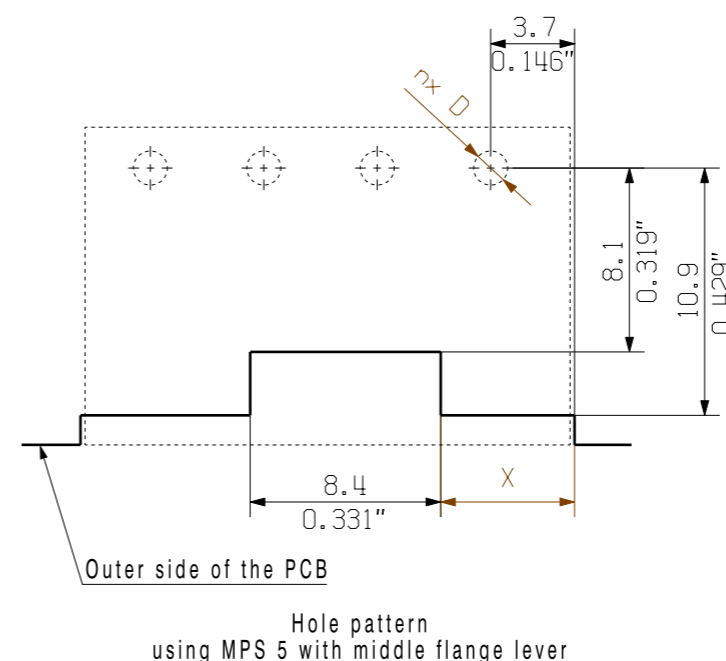
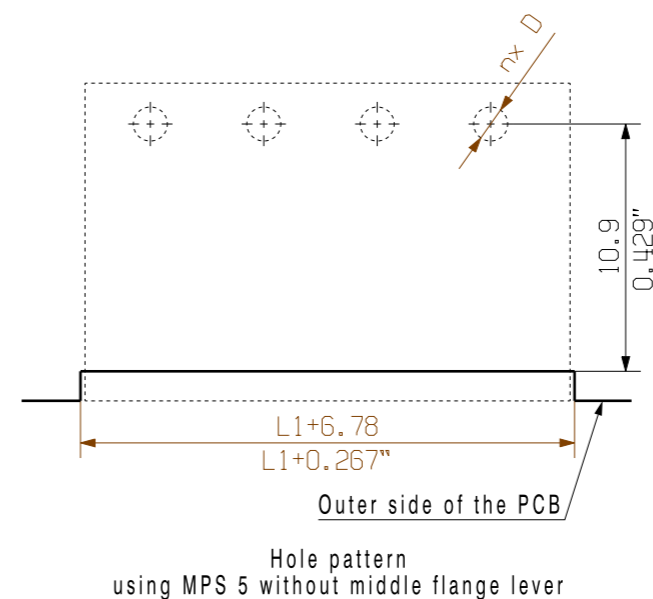
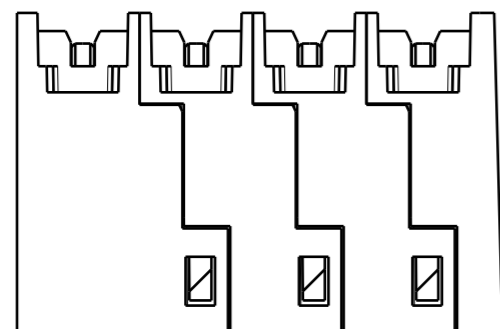
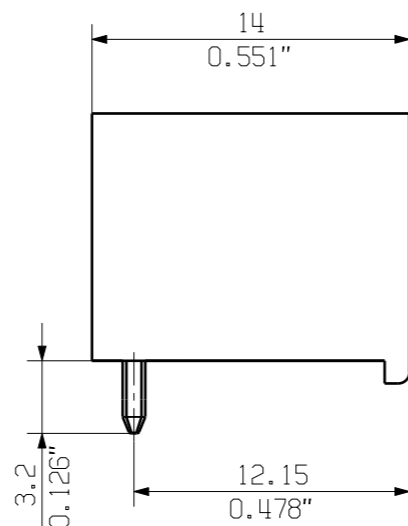
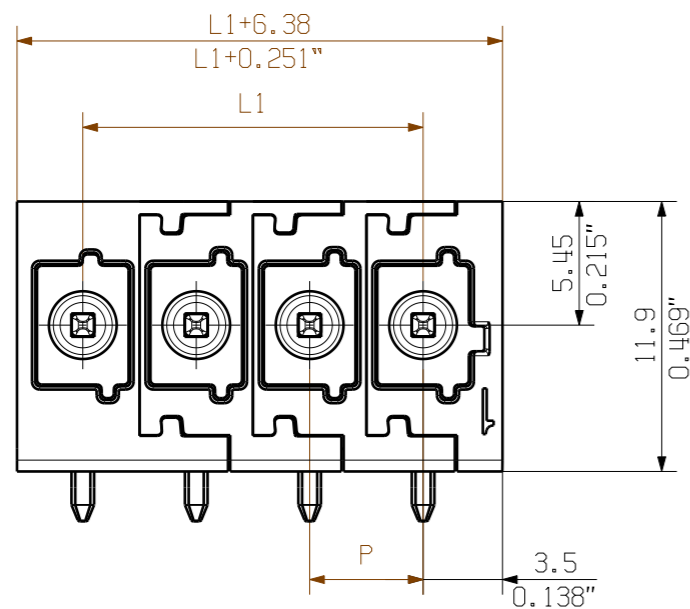

12	55.00	2.165	25.40	1.000
11	50.00	1.969	25.40	1.000
10	45.00	1.772	20.40	0.803
9	40.00	1.575	20.40	0.803
8	35.00	1.378	15.40	0.606
7	30.00	1.181	15.40	0.606
6	25.00	0.984	10.40	0.409
5	20.00	0.787	10.40	0.409
4	15.00	0.591	5.40	0.213
3	10.00	0.394	5.40	0.213
2	5.00	0.197	0.40	0.016
n Poles	L1 [mm]	L1 [inch]	X [mm]	X [inch]

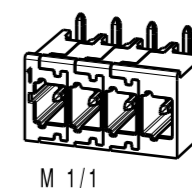

Further Dim. & Info. See data sheet

General tolerance:  
 DIN ISO 2768-mK

For the mounting of PCBs, it should be noted that the rated data relates only to the PCB components alone.  
 The necessary creepage and clearance paths must be observed in connection with the respective applicant in accordance to IEC 664 / VDE 0110.  
 The current-carrying capacity and pitch tolerance is to be determined according to DIN IEC 326 part 3 very fine.

Weidmueller PCB components are tested according to the DIN EN 61984 or to the DIN EN 60947-7-4 standard, and are valid for its field of application.  
 Provided that the components are used to the intended purpose, all requirements with respect to the occurring of electrical, mechanical, thermic and corrosive stress will be satisfied.

	EC00008107 P038108	Prim PLM Part No.: .	Prim ERP Part No.: .
	First Issue Date 27.01.2021	Max. nos. Modification	
		Date: 28.06.2021 Name: Reger, Marc Responsible: Stuckmann, Peter Approved: 29.09.2022 Stuckmann, Peter	<b>73985</b> Drawing no. Issue no. Sheet 2 of 2 sheets
Scale: ./. Size: A3		<b>MHS 5/... W T3 ...</b> STIFTLISTE MALE HEADER	
Drawings Assembly		Product file:	

## Recommended wave soldering profiles

**Weidmüller Interface GmbH & Co. KG**  
 Klingenbergstraße 16  
 D-32758 Detmold  
 Germany  
 Fon: +49 5231 14-0  
 Fax: +49 5231 14-292083  
 www.weidmueller.com

### Single Wave:



### Double Wave:



### Wave soldering profiles

Wired connection elements should be processed in accordance with the DIN EN 61760-1 standard. We have included two recommendations for practical wave soldering profiles, with which Weidmüller PCB terminals and connectors are qualified.

When choosing a suitable profile for your application, the following factors also need to be considered:

- PCB thickness
- Proportion of Cu in the layers
- Single/double-sided assembly
- Product range
- Heating and cooling rates

The single and double wave profiles each indicate the recommended operating range, including the maximum soldering temperature of 260°C. In practice, the maximum soldering temperature is quite often well below the above maximum profile.

## Recommended reflow soldering profile

**Weidmüller Interface GmbH & Co. KG**  
 Klingenbergstraße 16  
 D-32758 Detmold  
 Germany  
 Fon: +49 5231 14-0  
 Fax: +49 5231 14-292083  
 www.weidmueller.com



### Reflow soldering profile

The perfect soldering profile for SMT Surface Mount Technology is one the most exiting question in SMT production. But there are more than one correct answer: The diagram of temperature-on-time is related to processing features of solder paste and to maximum load of components.

We have to consider the following parameters:

- Time for pre heating
- Maximum temperature
- Time above melting point
- Time for cooling
- Maximum heating rate
- Maximum cooling rate

We recommend a typical solder profile with associated process limits. With preheating components and board are prepared smoothly for the solder phase. Heating rate is typically  $\leq +3\text{K/s}$ . In parallel the solder paste is ‚activated‘. The time above melting point of 217°C the paste gets liquid and components and boards begin to connect. The maximum temperature of 245°C to 254°C should stay between 10 and 40 seconds. In the cooling phase at  $\geq -6\text{K/s}$  solder is cured. Board and components cool down while avoiding cold cracks.