

UPBV 2,5/ 1-R BU - Plug

3045389

<https://www.phoenixcontact.com/us/products/3045389>



Please be informed that the data shown in this PDF document is generated from our online catalog. Please find the complete data in the user documentation. Our general terms of use for downloads are valid.



Plug, nom. voltage: 500 V, nominal current: 24 A, number of positions: 1, connection method: Screw connection, Rated cross section: 2.5 mm², cross section: 0.14 mm²- 4 mm², color: blue

Product description

Connector element right, left housing with engagement pin, right closed with cover

Your advantages

- Can be bridged with FBS ... standard bridges
- The COMBI plugs for self-assembly provide solutions that users can implement themselves
- The screw plugs can be combined with COMBI terminal blocks with all forms of connection technology and are available in two versions
- The plugs are assembled directly on site by snapping together 1-position plug elements
- The connected conductors can be led directly into the cable duct to save space

Commercial data

Item number	3045389
Packing unit	50 pc
Minimum order quantity	50 pc
Sales key	BE01
Product key	BE1144
Catalog page	Page 307 (C-1-2019)
GTIN	4046356055598
Weight per piece (including packing)	5.834 g
Weight per piece (excluding packing)	5.734 g
Customs tariff number	85366990
Country of origin	TR

UPBV 2,5/ 1-R BU - Plug



3045389

<https://www.phoenixcontact.com/us/products/3045389>

Technical data

Product properties

Product type	Terminal plug
Number of positions	1
Pitch	5.2 mm
Potentials	1

Insulation characteristics

Overvoltage category	III
Degree of pollution	3

Electrical properties

Rated surge voltage	6 kV
---------------------	------

Connection data

Nominal cross section	2.5 mm ²
Screw thread	M3
Tightening torque	0.5 ... 0.6 Nm
Stripping length	9 mm
Internal cylindrical gage	A3
Connection in acc. with standard	IEC 61984
Conductor cross section rigid	0.14 mm ² ... 4 mm ²
Cross section AWG	26 ... 12 (converted acc. to IEC)
Conductor cross section flexible	0.14 mm ² ... 4 mm ²
Conductor cross section, flexible [AWG]	26 ... 12 (converted acc. to IEC)
Conductor cross-section flexible (ferrule without plastic sleeve)	0.14 mm ² ... 2.5 mm ²
Flexible conductor cross section (ferrule with plastic sleeve)	0.14 mm ² ... 2.5 mm ²
2 conductors with same cross section, solid	0.14 mm ² ... 1.5 mm ²
2 conductors with same cross section, flexible	0.14 mm ² ... 1.5 mm ²
2 conductors with same cross section, flexible, with ferrule without plastic sleeve	0.14 mm ² ... 1.5 mm ²
2 conductors with the same cross section, flexible, with TWIN ferrule with plastic sleeve	0.5 mm ² ... 1 mm ²
Nominal current	24 A
Maximum load current	24 A (with 4 mm ² conductor cross section)
Nominal voltage	500 V
Nominal cross section	2.5 mm ²

Dimensions

Width	5.2 mm
Height	20.5 mm
Depth	47 mm
Length	20.5 mm
Pitch	5.2 mm

UPBV 2,5/ 1-R BU - Plug



3045389

<https://www.phoenixcontact.com/us/products/3045389>

Material specifications

Color	blue
Flammability rating according to UL 94	V0
Insulating material group	I
Insulating material	PA
Static insulating material application in cold	-60 °C
Temperature index of insulation material (DIN EN 60216-1 (VDE 0304-21))	130 °C
Relative insulation material temperature index (Elec., UL 746 B)	130 °C
Fire protection for rail vehicles (DIN EN 45545-2) R22	HL 1 - HL 3
Fire protection for rail vehicles (DIN EN 45545-2) R23	HL 1 - HL 3
Fire protection for rail vehicles (DIN EN 45545-2) R24	HL 1 - HL 3
Fire protection for rail vehicles (DIN EN 45545-2) R26	HL 1 - HL 3
Calorimetric heat release NFPA 130 (ASTM E 1354)	28 MJ/kg
Surface flammability NFPA 130 (ASTM E 162)	passed
Specific optical density of smoke NFPA 130 (ASTM E 662)	passed
Smoke gas toxicity NFPA 130 (SMP 800C)	passed

Environmental and real-life conditions

Ambient conditions

Ambient temperature (operation)	-60 °C (max. operating temperature see derating curve)
Ambient temperature (storage/transport)	-25 °C ... 60 °C (for a short time, no longer than 24 h, -60°C to +70°C)
Ambient temperature (assembly)	-5 °C ... 70 °C
Ambient temperature (actuation)	-5 °C ... 70 °C
Permissible humidity (operation)	20 % ... 90 %
Permissible humidity (storage/transport)	30 % ... 70 %

Standards and regulations

Connection in acc. with standard	IEC 61984
----------------------------------	-----------

UPBV 2,5/ 1-R BU - Plug

3045389

<https://www.phoenixcontact.com/us/products/3045389>



Drawings

Circuit diagram



UPBV 2,5/ 1-R BU - Plug

3045389

<https://www.phoenixcontact.com/us/products/3045389>



Schematic diagram

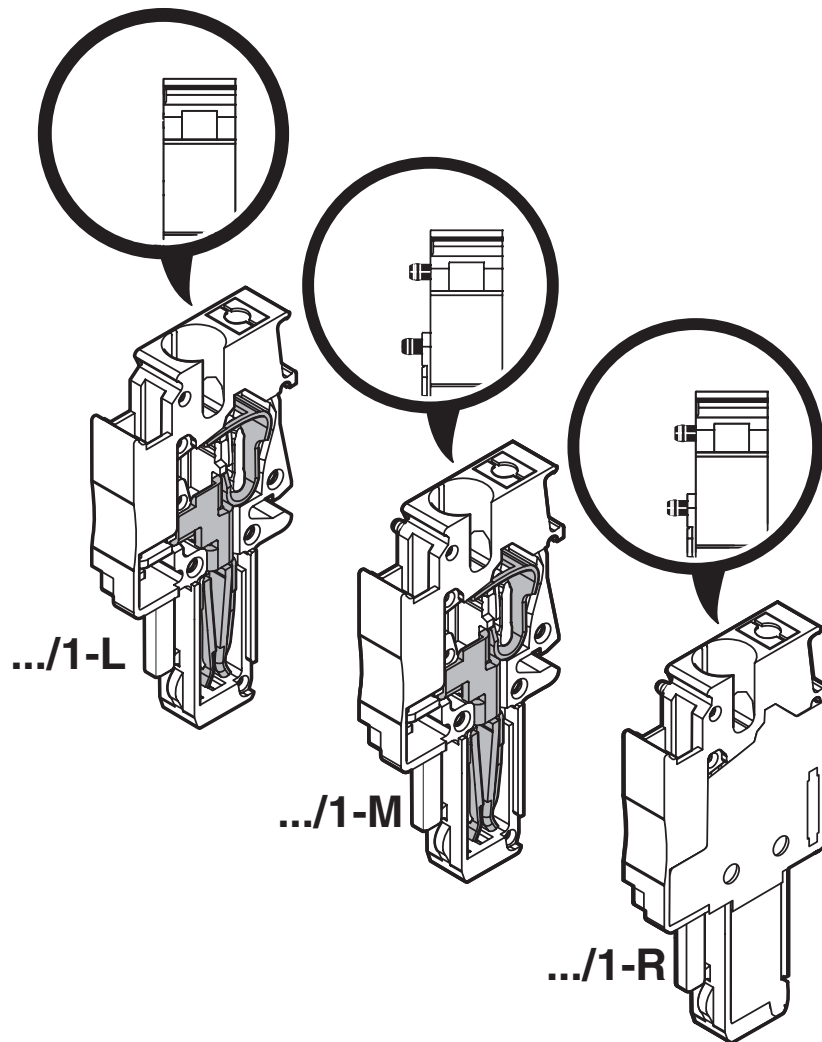

Diagram

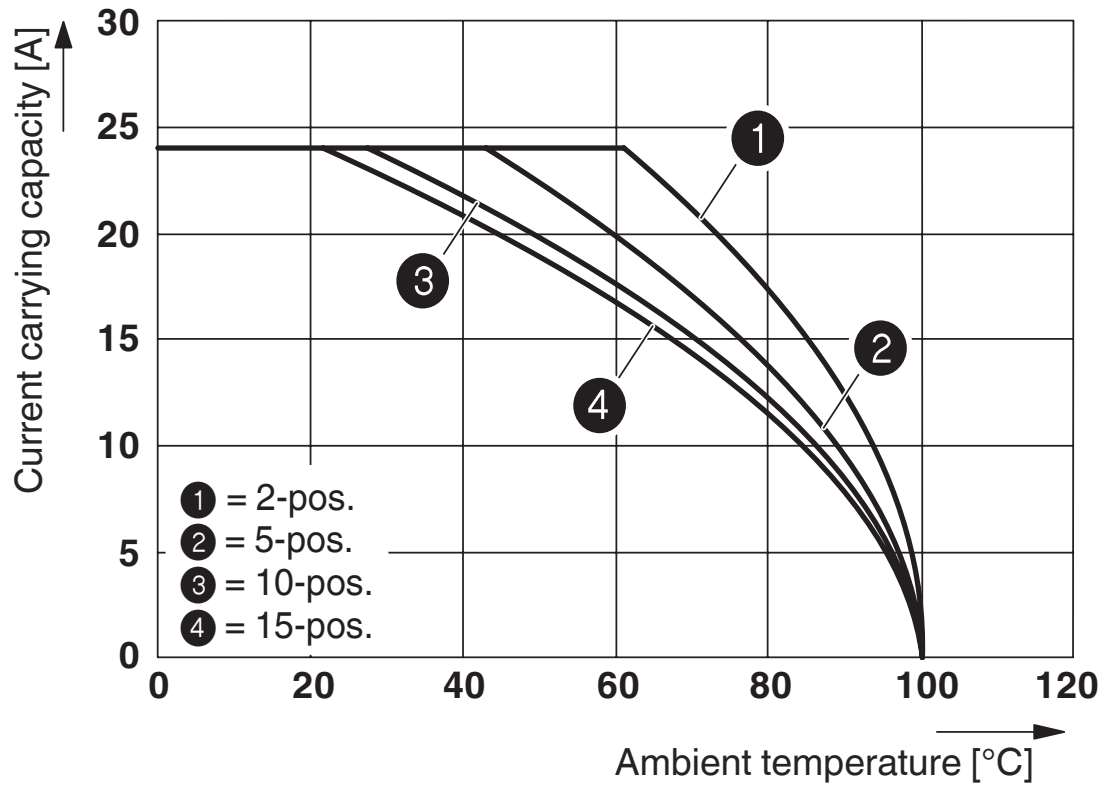

The figure shows the derating curve of the UT 2,5/1P... terminal block in connection with the UPBV 2,5 plug

UPBV 2,5/ 1-R BU - Plug



3045389

<https://www.phoenixcontact.com/us/products/3045389>

Approvals

To download certificates, visit the product detail page: <https://www.phoenixcontact.com/us/products/3045389>



EAC

Approval ID: RU C-DE.BL08.B.00511



cULus Recognized

Approval ID: E60425

	Nominal voltage U_N	Nominal current I_N	Cross section AWG	Cross section mm^2
Use group B				
	600 V	20 A	26 - 12	-
Multi-conductor connection	600 V	20 A	26 - 16	-
Use group C				
	600 V	20 A	26 - 12	-
Multi-conductor connection	600 V	20 A	26 - 16	-
Use group D				
	600 V	5 A	26 - 12	-
Multi-conductor connection	600 V	5 A	26 - 16	-

UPBV 2,5/ 1-R BU - Plug

3045389

<https://www.phoenixcontact.com/us/products/3045389>



Classifications

ECLASS

ECLASS-11.0	27141151
ECLASS-12.0	27141151
ECLASS-13.0	27250306

ETIM

ETIM 9.0	EC002021
----------	----------

UNSPSC

UNSPSC 21.0	39121400
-------------	----------

UPBV 2,5/ 1-R BU - Plug

3045389

<https://www.phoenixcontact.com/us/products/3045389>



Environmental product compliance

EU RoHS

Fulfills EU RoHS substance requirements	Yes
Exemption	6(c)

China RoHS

Environment friendly use period (EFUP)	EFUP-50
	An article-related China RoHS declaration table can be found in the download area for the respective article under "Manufacturer declaration". For all articles with EFUP-E, no China RoHS declaration table issued and required.

EU REACH SVHC

REACH candidate substance (CAS No.)	Lead(CAS: 7439-92-1)
-------------------------------------	----------------------

UPBV 2,5/ 1-R BU - Plug

3045389

<https://www.phoenixcontact.com/us/products/3045389>



Accessories

i Note: Applying some accessories below might limit this product.

FBS 2-5 - Plug-in bridge

3030161

<https://www.phoenixcontact.com/us/products/3030161>



Plug-in bridge, pitch: 5.2 mm, number of positions: 2, length: 23 mm, color: red

i Max. current carrying capacity: 24 A

FBS 3-5 - Plug-in bridge

3030174

<https://www.phoenixcontact.com/us/products/3030174>



Plug-in bridge, pitch: 5.2 mm, number of positions: 3, length: 23 mm, color: red

i Max. current carrying capacity: 24 A

UPBV 2,5/ 1-R BU - Plug

3045389

<https://www.phoenixcontact.com/us/products/3045389>



FBS 4-5 - Plug-in bridge

3030187

<https://www.phoenixcontact.com/us/products/3030187>



Plug-in bridge, pitch: 5.2 mm, number of positions: 4, length: 23 mm, color: red

 Max. current carrying capacity: 24 A

FBS 5-5 - Plug-in bridge

3030190

<https://www.phoenixcontact.com/us/products/3030190>



Plug-in bridge, pitch: 5.2 mm, number of positions: 5, length: 23 mm, color: red

 Max. current carrying capacity: 24 A

UPBV 2,5/ 1-R BU - Plug

3045389

<https://www.phoenixcontact.com/us/products/3045389>



FBS 10-5 - Plug-in bridge

3030213

<https://www.phoenixcontact.com/us/products/3030213>



Plug-in bridge, pitch: 5.2 mm, number of positions: 10, length: 23 mm, color: red

 Max. current carrying capacity: 24 A

FBS 20-5 - Plug-in bridge

3030226

<https://www.phoenixcontact.com/us/products/3030226>



Plug-in bridge, pitch: 5.2 mm, number of positions: 20, color: red

 Max. current carrying capacity: 24 A

UPBV 2,5/ 1-R BU - Plug

3045389

<https://www.phoenixcontact.com/us/products/3045389>



FBS 50-5 - Plug-in bridge

3038930

<https://www.phoenixcontact.com/us/products/3038930>



Plug-in bridge, pitch: 5.2 mm, number of positions: 50, color: red

 Max. current carrying capacity: 24 A

FBSR 2-5 - Plug-in bridge

3033702

<https://www.phoenixcontact.com/us/products/3033702>



Plug-in bridge, pitch: 5.2 mm, number of positions: 2, color: red

 Max. current carrying capacity: 17.5 A

UPBV 2,5/ 1-R BU - Plug

3045389

<https://www.phoenixcontact.com/us/products/3045389>



FBSR 3-5 - Plug-in bridge

3001591

<https://www.phoenixcontact.com/us/products/3001591>



Plug-in bridge, pitch: 5.2 mm, number of positions: 3, color: red

 Max. current carrying capacity: 17.5 A

FBSR 4-5 - Plug-in bridge

3001592

<https://www.phoenixcontact.com/us/products/3001592>



Plug-in bridge, pitch: 5.2 mm, number of positions: 4, color: red

 Max. current carrying capacity: 17.5 A

UPBV 2,5/ 1-R BU - Plug

3045389

<https://www.phoenixcontact.com/us/products/3045389>



FBSR 5-5 - Plug-in bridge

3001593

<https://www.phoenixcontact.com/us/products/3001593>

Plug-in bridge, pitch: 5.2 mm, number of positions: 5, color: red



 Max. current carrying capacity: 17.5 A

FBSR 10-5 - Plug-in bridge

3033710

<https://www.phoenixcontact.com/us/products/3033710>

Plug-in bridge, pitch: 5.2 mm, number of positions: 10, color: red



 Max. current carrying capacity: 17.5 A

UPBV 2,5/ 1-R BU - Plug

3045389

<https://www.phoenixcontact.com/us/products/3045389>



FBS 2-5 BU - Plug-in bridge

3036877

<https://www.phoenixcontact.com/us/products/3036877>



Plug-in bridge, pitch: 5.2 mm, number of positions: 2, color: blue

 Max. current carrying capacity: 24 A

FBS 3-5 BU - Plug-in bridge

3036880

<https://www.phoenixcontact.com/us/products/3036880>



Plug-in bridge, pitch: 5.2 mm, number of positions: 3, color: blue

 Max. current carrying capacity: 24 A

UPBV 2,5/ 1-R BU - Plug

3045389

<https://www.phoenixcontact.com/us/products/3045389>



FBS 4-5 BU - Plug-in bridge

3036893

<https://www.phoenixcontact.com/us/products/3036893>



Plug-in bridge, pitch: 5.2 mm, number of positions: 4, color: blue

 Max. current carrying capacity: 24 A

FBS 5-5 BU - Plug-in bridge

3036903

<https://www.phoenixcontact.com/us/products/3036903>



Plug-in bridge, pitch: 5.2 mm, number of positions: 5, color: blue

 Max. current carrying capacity: 24 A

UPBV 2,5/ 1-R BU - Plug

3045389

<https://www.phoenixcontact.com/us/products/3045389>



FBS 10-5 BU - Plug-in bridge

3036916

<https://www.phoenixcontact.com/us/products/3036916>



Plug-in bridge, pitch: 5.2 mm, number of positions: 10, color: blue

 Max. current carrying capacity: 24 A

FBS 20-5 BU - Plug-in bridge

3036929

<https://www.phoenixcontact.com/us/products/3036929>



Plug-in bridge, pitch: 5.2 mm, number of positions: 20, color: blue

 Max. current carrying capacity: 24 A

UPBV 2,5/ 1-R BU - Plug

3045389

<https://www.phoenixcontact.com/us/products/3045389>



FBS 50-5 BU - Plug-in bridge

3032114

<https://www.phoenixcontact.com/us/products/3032114>



Plug-in bridge, pitch: 5.2 mm, number of positions: 50, color: blue

 Max. current carrying capacity: 24 A

UPRZ - Latching

3045570

<https://www.phoenixcontact.com/us/products/3045570>



Latching, width: 10 mm, height: 39.8 mm, number of positions: 2, color: orange

UPBV 2,5/ 1-R BU - Plug

3045389

<https://www.phoenixcontact.com/us/products/3045389>



UPR/ 2 - Latching

3045567

<https://www.phoenixcontact.com/us/products/3045567>



Latching, width: 10 mm, height: 39.8 mm, number of positions: 2, color: orange

UPZ/ 2 - Strain relief

3045554

<https://www.phoenixcontact.com/us/products/3045554>



Strain relief, width: 9.3 mm, height: 36.7 mm, number of positions: 2, color: black

UPBV 2,5/ 1-R BU - Plug

3045389

<https://www.phoenixcontact.com/us/products/3045389>



DF-UPBV 2,5/ 4 - Flange cover

3060432

<https://www.phoenixcontact.com/us/products/3060432>



Flange cover, can be snapped onto the UPBV 2,5/... and UPBV 4/... plugs, connection method: Screw connection, depth: 32 mm, width: 4.5 mm, height: 45.7 mm, color: gray

UPBV 2,5/ 1-L - Plug

3045318

<https://www.phoenixcontact.com/us/products/3045318>



Plug, nom. voltage: 500 V, nominal current: 24 A, number of positions: 1, connection method: Screw connection, Rated cross section: 2.5 mm², cross section: 0.14 mm²- 4 mm², color: gray

UPBV 2,5/ 1-R BU - Plug

3045389

<https://www.phoenixcontact.com/us/products/3045389>



UPBV 2,5/ 1-L BU - Plug

3045321

<https://www.phoenixcontact.com/us/products/3045321>



Plug, nom. voltage: 500 V, nominal current: 24 A, number of positions: 1, connection method: Screw connection, Rated cross section: 2.5 mm², cross section: 0.14 mm²- 4 mm², color: blue

UPBV 2,5/ 1-L GNYE - Plug

3045334

<https://www.phoenixcontact.com/us/products/3045334>



Plug, nom. voltage: 500 V, nominal current: 24 A, number of positions: 1, connection method: Screw connection, Rated cross section: 2.5 mm², cross section: 0.14 mm²- 4 mm², color: green-yellow

UPBV 2,5/ 1-R BU - Plug

3045389

<https://www.phoenixcontact.com/us/products/3045389>



UPBV 2,5/ 1-M - Plug

3045347

<https://www.phoenixcontact.com/us/products/3045347>



Plug, nom. voltage: 500 V, nominal current: 24 A, number of positions: 1, connection method: Screw connection, Rated cross section: 2.5 mm², cross section: 0.14 mm²- 4 mm², color: gray

UPBV 2,5/ 1-M BU - Plug

3045350

<https://www.phoenixcontact.com/us/products/3045350>



Plug, nom. voltage: 500 V, nominal current: 24 A, number of positions: 1, connection method: Screw connection, Rated cross section: 2.5 mm², cross section: 0.14 mm²- 4 mm², color: blue

UPBV 2,5/ 1-R BU - Plug

3045389

<https://www.phoenixcontact.com/us/products/3045389>



UPBV 2,5/ 1-M GNYE - Plug

3045363

<https://www.phoenixcontact.com/us/products/3045363>



Plug, nom. voltage: 500 V, nominal current: 24 A, number of positions: 1, connection method: Screw connection, Rated cross section: 2.5 mm², cross section: 0.14 mm²- 4 mm², color: green-yellow

LPO 2,5/E - Pick-off plug

3270516

<https://www.phoenixcontact.com/us/products/3270516>



Pick-off plug, nom. voltage: 800 V, nominal current: 24 A, number of positions: 1, connection method: Push-in connection, Rated cross section: 2.5 mm², cross section: 0.14 mm²- 4 mm², color: gray

UPBV 2,5/ 1-R BU - Plug

3045389

<https://www.phoenixcontact.com/us/products/3045389>



LPO 2,5 - Pick-off plug

3270517

<https://www.phoenixcontact.com/us/products/3270517>



Pick-off plug, nom. voltage: 800 V, nominal current: 24 A, number of positions: 1, connection method: Push-in connection, Rated cross section: 2.5 mm², cross section: 0.14 mm²- 4 mm², color: gray

LPS-5/E - Service connector

3270520

<https://www.phoenixcontact.com/us/products/3270520>



Service connector, nom. voltage: 800 V, nominal current: 24 A, number of positions: 1, connection method: Push-in connection, Rated cross section: 2.5 mm², cross section: 0.14 mm²- 4 mm², color: red

UPBV 2,5/ 1-R BU - Plug

3045389

<https://www.phoenixcontact.com/us/products/3045389>



LPS-5 - Service connector

3270521

<https://www.phoenixcontact.com/us/products/3270521>



Service connector, nom. voltage: 800 V, nominal current: 24 A, number of positions: 1, connection method: Push-in connection, Rated cross section: 2.5 mm², cross section: 0.14 mm²- 4 mm², color: red

MPS-MT - Test plug

0201744

<https://www.phoenixcontact.com/us/products/0201744>



Test plug, with solder connection up to 1 mm² conductor cross section, number of positions: 1, color: gray

UPBV 2,5/ 1-R BU - Plug

3045389

<https://www.phoenixcontact.com/us/products/3045389>



MPS-IH WH - Insulating sleeve

0201663

<https://www.phoenixcontact.com/us/products/0201663>

Insulating sleeve, color: white



MPS-IH RD - Insulating sleeve

0201676

<https://www.phoenixcontact.com/us/products/0201676>

Insulating sleeve, color: red



UPBV 2,5/ 1-R BU - Plug

3045389

<https://www.phoenixcontact.com/us/products/3045389>



MPS-IH BU - Insulating sleeve

0201689

<https://www.phoenixcontact.com/us/products/0201689>

Insulating sleeve, color: blue

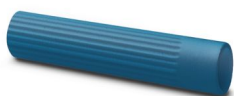

MPS-IH YE - Insulating sleeve

0201692

<https://www.phoenixcontact.com/us/products/0201692>

Insulating sleeve, color: yellow



UPBV 2,5/ 1-R BU - Plug

3045389

<https://www.phoenixcontact.com/us/products/3045389>



MPS-IH GN - Insulating sleeve

0201702

<https://www.phoenixcontact.com/us/products/0201702>

Insulating sleeve, color: green



MPS-IH GY - Insulating sleeve

0201728

<https://www.phoenixcontact.com/us/products/0201728>

Insulating sleeve, color: gray



UPBV 2,5/ 1-R BU - Plug

3045389

<https://www.phoenixcontact.com/us/products/3045389>



MPS-IH BK - Insulating sleeve

0201731

<https://www.phoenixcontact.com/us/products/0201731>

Insulating sleeve, color: black



PAI-4-N GY - Test adapter

3032871

<https://www.phoenixcontact.com/us/products/3032871>

4 mm test adapter, for terminal blocks with 5.2 mm, 6.2 mm and 8.2 mm pitch



UPBV 2,5/ 1-R BU - Plug

3045389

<https://www.phoenixcontact.com/us/products/3045389>



PS-5 - Test plug

3030983

<https://www.phoenixcontact.com/us/products/3030983>



Test plug, Modular test plug, number of positions: 1, color: red

DP PS-5 - Spacer plate

3036725

<https://www.phoenixcontact.com/us/products/3036725>



Spacer plate, depth: 29 mm, width: 5.2 mm, height: 22.4 mm, number of positions: 1, color: red

UPBV 2,5/ 1-R BU - Plug

3045389

<https://www.phoenixcontact.com/us/products/3045389>



PS-5/2,3MM RD - Test plug

3038723

<https://www.phoenixcontact.com/us/products/3038723>



Test plug, number of positions: 1, color: red

ZBF 5:UNBEDRUCKT - Zack Marker strip, flat

0808642

<https://www.phoenixcontact.com/us/products/0808642>



Zack Marker strip, flat, Strip, white, unlabeled, can be labeled with: PLOTMARK, CMS-P1-PLOTTER, mounting type: snapped, for terminal block width: 5 mm, lettering field size: 5.1 x 5.2 mm, Number of individual labels: 10

UPBV 2,5/ 1-R BU - Plug

3045389

<https://www.phoenixcontact.com/us/products/3045389>



ZBF 5 CUS - Zack Marker strip, flat

0825025

<https://www.phoenixcontact.com/us/products/0825025>



Zack Marker strip, flat, can be ordered: Strip, white, labeled according to customer specifications, mounting type: snap into flat marker groove, for terminal block width: 5 mm, lettering field size: 5.15 x 5.15 mm, Number of individual labels: 10

ZBF 5,LGS:FORTL.ZAHLEN - Zack Marker strip, flat

0808671

<https://www.phoenixcontact.com/us/products/0808671>



Zack Marker strip, flat, Strip, white, labeled, printed horizontally: consecutive numbers 1 ... 10, 11 ... 20, etc. up to 491 ... 500, mounting type: snapped, for terminal block width: 5 mm, lettering field size: 5.15 x 5.15 mm, Number of individual labels: 10

UPBV 2,5/ 1-R BU - Plug

3045389

<https://www.phoenixcontact.com/us/products/3045389>



ZBF 5,QR:FORTL.ZAHLEN - Zack Marker strip, flat

0808697

<https://www.phoenixcontact.com/us/products/0808697>



Zack Marker strip, flat, Strip, white, labeled, Printed vertically: consecutive numbers 1 ... 10, 11 ... 20, etc. up to 91 ... 100, mounting type: snapped, for terminal block width: 5 mm, lettering field size: 5.15 x 5.15 mm, Number of individual labels: 10

ZBF 5,LGS:GERADE ZAHLEN - Zack Marker strip, flat

0810821

<https://www.phoenixcontact.com/us/products/0810821>



Zack Marker strip, flat, Strip, white, labeled, printed horizontally: consecutive even numbers 2 ... 20, 22 ... 40, etc. up to 82 ... 100, mounting type: snapped, for terminal block width: 5 mm, lettering field size: 5.15 x 5.15 mm, Number of individual labels: 10

UPBV 2,5/ 1-R BU - Plug

3045389

<https://www.phoenixcontact.com/us/products/3045389>



ZBF 5,LGS:UNGERADE ZAHLEN - Zack Marker strip, flat

0810863

<https://www.phoenixcontact.com/us/products/0810863>



Zack Marker strip, flat, Strip, white, labeled, printed horizontally: Odd numbers 1 - 19, 21 - 39, etc. up to 81 - 99, mounting type: snapped, for terminal block width: 5 mm, lettering field size: 5.15 x 5.15 mm, Number of individual labels: 10

UC-TMF 5 - Marker for terminal blocks

0818153

<https://www.phoenixcontact.com/us/products/0818153>

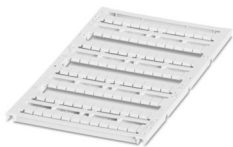

Marker for terminal blocks, Sheet, white, unlabeled, can be labeled with: BLUEMARK ID COLOR, BLUEMARK ID, BLUEMARK CLED, PLOTMARK, CMS-P1-PLOTTER, mounting type: snapped, for terminal block width: 5.2 mm, lettering field size: 4.6 x 5.1 mm, Number of individual labels: 96

UPBV 2,5/ 1-R BU - Plug

3045389

<https://www.phoenixcontact.com/us/products/3045389>



UC-TMF 5 CUS - Marker for terminal blocks

0824638

<https://www.phoenixcontact.com/us/products/0824638>

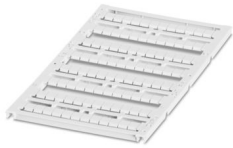

Marker for terminal blocks, can be ordered: by sheet, white, labeled according to customer specifications, mounting type: snap into flat marker groove, for terminal block width: 5.2 mm, lettering field size: 4.6 x 5.1 mm, Number of individual labels: 96

UCT-TMF 5 - Marker for terminal blocks

0828744

<https://www.phoenixcontact.com/us/products/0828744>



Marker for terminal blocks, Sheet, white, unlabeled, can be labeled with: TOPMARK NEO, TOPMARK LASER, BLUEMARK ID COLOR, BLUEMARK ID, BLUEMARK CLED, THERMOMARK PRIME, THERMOMARK CARD 2.0, THERMOMARK CARD, mounting type: snapped, for terminal block width: 5.2 mm, lettering field size: 4.4 x 4.7 mm, Number of individual labels: 72

UPBV 2,5/ 1-R BU - Plug

3045389

<https://www.phoenixcontact.com/us/products/3045389>



UCT-TMF 5 CUS - Marker for terminal blocks

0829658

<https://www.phoenixcontact.com/us/products/0829658>



Marker for terminal blocks, can be ordered: by sheet, white, labeled according to customer specifications, mounting type: snap into flat marker groove, for terminal block width: 5.2 mm, lettering field size: 4.4 x 4.7 mm, Number of individual labels: 72

SZS 0,6X3,5 - Screwdriver

1205053

<https://www.phoenixcontact.com/us/products/1205053>



Actuation tool, for ST terminal blocks, insulated, also suitable for use as a bladed screwdriver, size: 0.6 x 3.5 x 100 mm, 2-component grip, with non-slip grip

UPBV 2,5/ 1-R BU - Plug

3045389

<https://www.phoenixcontact.com/us/products/3045389>



SF-SL 0,6X3,5-100 S-VDE - Screwdriver

1212587

<https://www.phoenixcontact.com/us/products/1212587>



Actuation tool, for ST terminal blocks, VDE insulated, with slimmer insulation integrated in the blade, also suitable for use as a bladed screwdriver, size: 0.6 x 3.5 x 100 mm, 2-component grip, with non-slip grip

Phoenix Contact 2024 © - all rights reserved

<https://www.phoenixcontact.com>

Phoenix Contact USA
586 Fulling Mill Road
Middletown, PA 17057, United States
(+717) 944-1300
info@phoenixcon.com