

SP 2,5/ 1-R GNYE - Plug

3043093

<https://www.phoenixcontact.com/us/products/3043093>

Please be informed that the data shown in this PDF document is generated from our online catalog. Please find the complete data in the user documentation. Our general terms of use for downloads are valid.



Plug, nom. voltage: 500 V, nominal current: 24 A, number of positions: 1, connection method: Spring-cage connection, Rated cross section: 2.5 mm², cross section: 0.08 mm²- 4 mm², color: green-yellow

Product description

Connector element right, left housing with engagement pin, right closed with cover

Your advantages

- Cable housing can be snapped on to the plugs, see figure below
- The plug with spring-cage connection is assembled directly on site by snapping together single-position plug elements
- The ST-COMBI plugs for self-assembly provide solutions that users can implement themselves

Commercial data

Item number	3043093
Packing unit	50 pc
Minimum order quantity	50 pc
Sales key	BE02
Product key	BE2144
Catalog page	Page 318 (C-1-2019)
GTIN	4017918894955
Weight per piece (including packing)	3.377 g
Weight per piece (excluding packing)	3 g
Customs tariff number	85366990
Country of origin	PL

SP 2,5/ 1-R GNYE - Plug



3043093

<https://www.phoenixcontact.com/us/products/3043093>

Technical data

Product properties

Product type	Terminal plug
Number of positions	1
Pitch	5.2 mm

Insulation characteristics

Overvoltage category	III
Degree of pollution	3

Electrical properties

Rated surge voltage	6 kV
---------------------	------

Connection data

Nominal cross section	2.5 mm ²
Stripping length	8 mm ... 10 mm
Internal cylindrical gage	A3
Connection in acc. with standard	IEC 61984
Conductor cross section rigid	0.08 mm ² ... 4 mm ²
Cross section AWG	28 ... 12 (converted acc. to IEC)
Conductor cross section flexible	0.08 mm ² ... 2.5 mm ²
Conductor cross section, flexible [AWG]	28 ... 14 (converted acc. to IEC)
Conductor cross-section flexible (ferrule without plastic sleeve)	0.14 mm ² ... 2.5 mm ²
Flexible conductor cross section (ferrule with plastic sleeve)	0.14 mm ² ... 2.5 mm ²
2 conductors with the same cross section, flexible, with TWIN ferrule with plastic sleeve	0.5 mm ²
Nominal current	24 A
Maximum load current	24 A (with 4 mm ² conductor cross section)
Nominal voltage	500 V
Nominal cross section	2.5 mm ²

Dimensions

Width	5.2 mm
Height	15.8 mm
Depth	39 mm
Length	15.8 mm
Pitch	5.2 mm

Material specifications

Color	green-yellow
Flammability rating according to UL 94	V0
Insulating material group	I
Insulating material	PA

SP 2,5/ 1-R GNYE - Plug



3043093

<https://www.phoenixcontact.com/us/products/3043093>

Static insulating material application in cold	-60 °C
Temperature index of insulation material (DIN EN 60216-1 (VDE 0304-21))	130 °C
Relative insulation material temperature index (Elec., UL 746 B)	130 °C
Fire protection for rail vehicles (DIN EN 45545-2) R22	HL 1 - HL 3
Fire protection for rail vehicles (DIN EN 45545-2) R23	HL 1 - HL 3
Fire protection for rail vehicles (DIN EN 45545-2) R24	HL 1 - HL 3
Fire protection for rail vehicles (DIN EN 45545-2) R26	HL 1 - HL 3
Calorimetric heat release NFPA 130 (ASTM E 1354)	28 MJ/kg
Surface flammability NFPA 130 (ASTM E 162)	passed
Specific optical density of smoke NFPA 130 (ASTM E 662)	passed
Smoke gas toxicity NFPA 130 (SMP 800C)	passed

Environmental and real-life conditions

Ambient conditions

Ambient temperature (operation)	-60 °C (max. operating temperature see derating curve)
Ambient temperature (storage/transport)	-25 °C ... 60 °C (for a short time, no longer than 24 h, -60°C to +70°C)
Ambient temperature (assembly)	-5 °C ... 70 °C
Ambient temperature (actuation)	-5 °C ... 70 °C
Permissible humidity (operation)	20 % ... 90 %
Permissible humidity (storage/transport)	30 % ... 70 %

Standards and regulations

Connection in acc. with standard	IEC 61984
----------------------------------	-----------

Drawings

Diagram

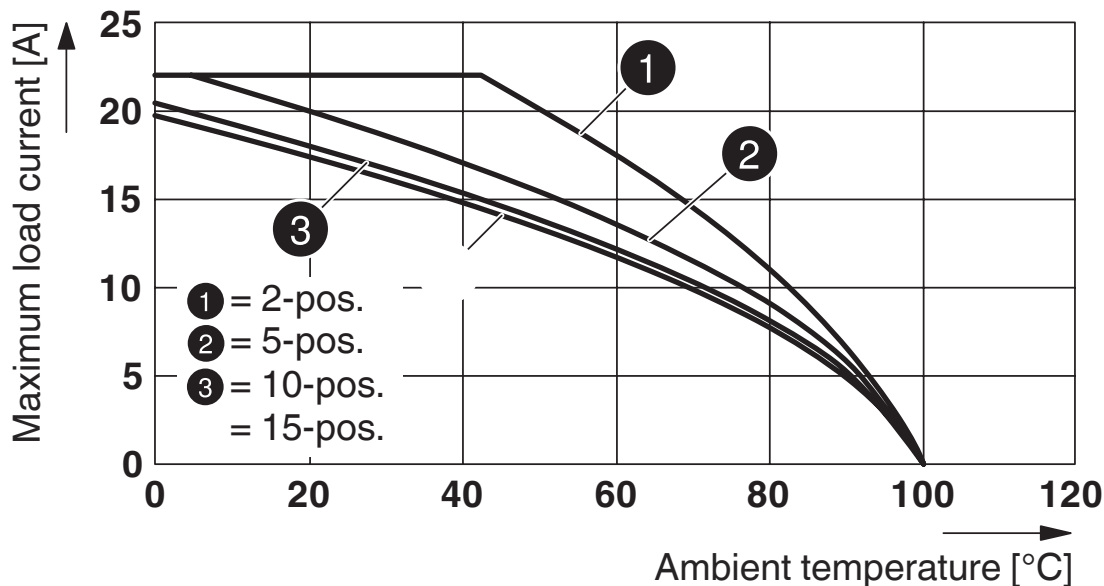

Derating curve for STTB 2,5/ 2P, STTB 2,5/ 2P-PV and for all plug versions SP...

Diagram

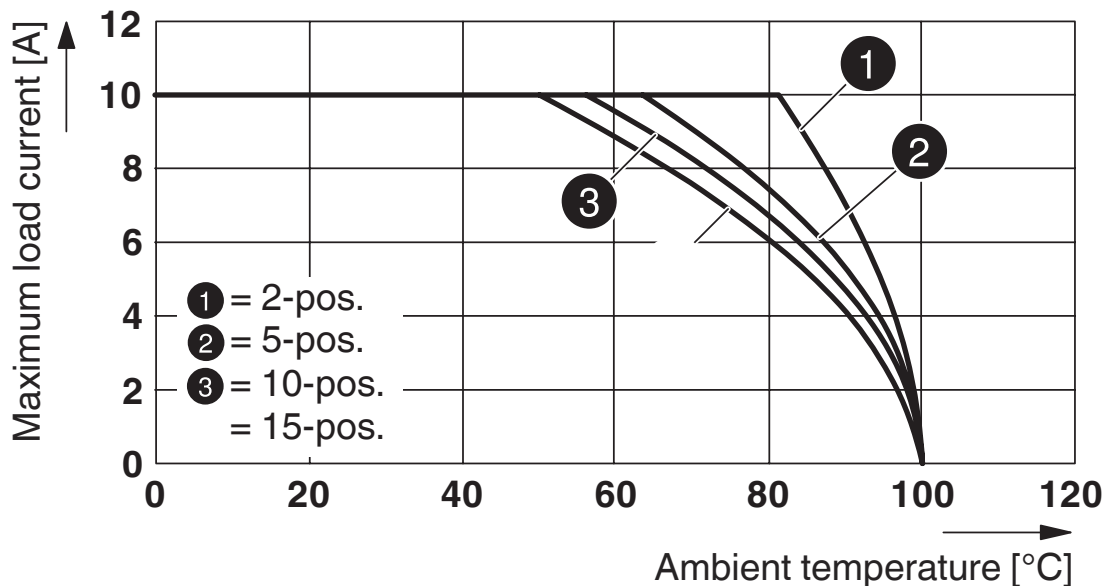

Derating curve for ST 2,5-4L/1P, ST 2,5-4L/2P and for all plug versions SP...

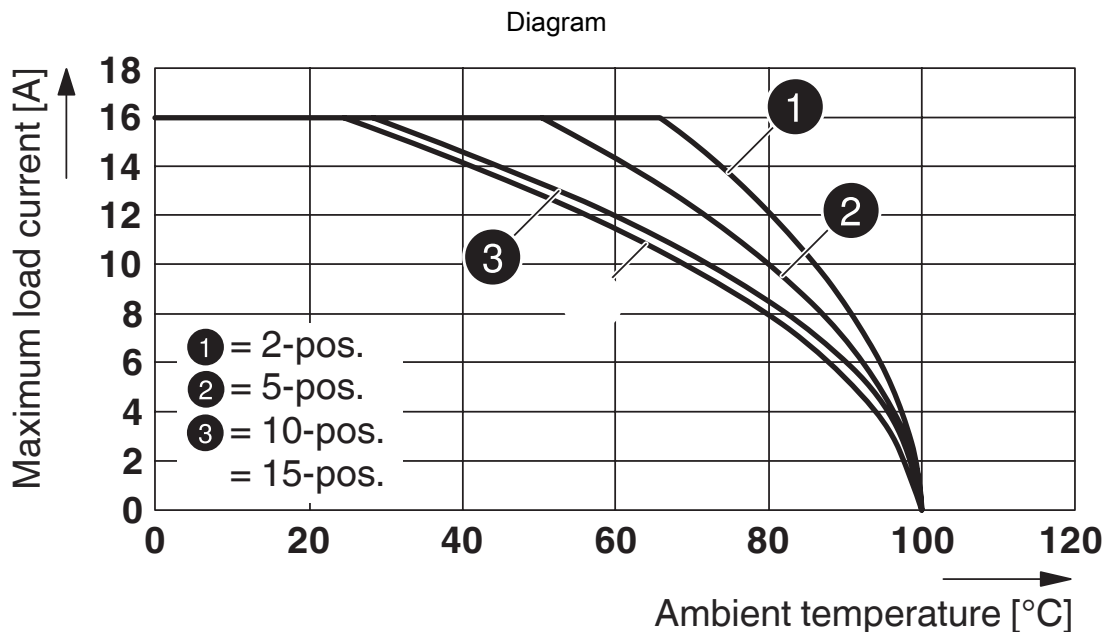

Derating curve for ST 2,5-TWIN-MT/1P, ST 2,5-TWIN-TG/1P and for all plug versions SP... .

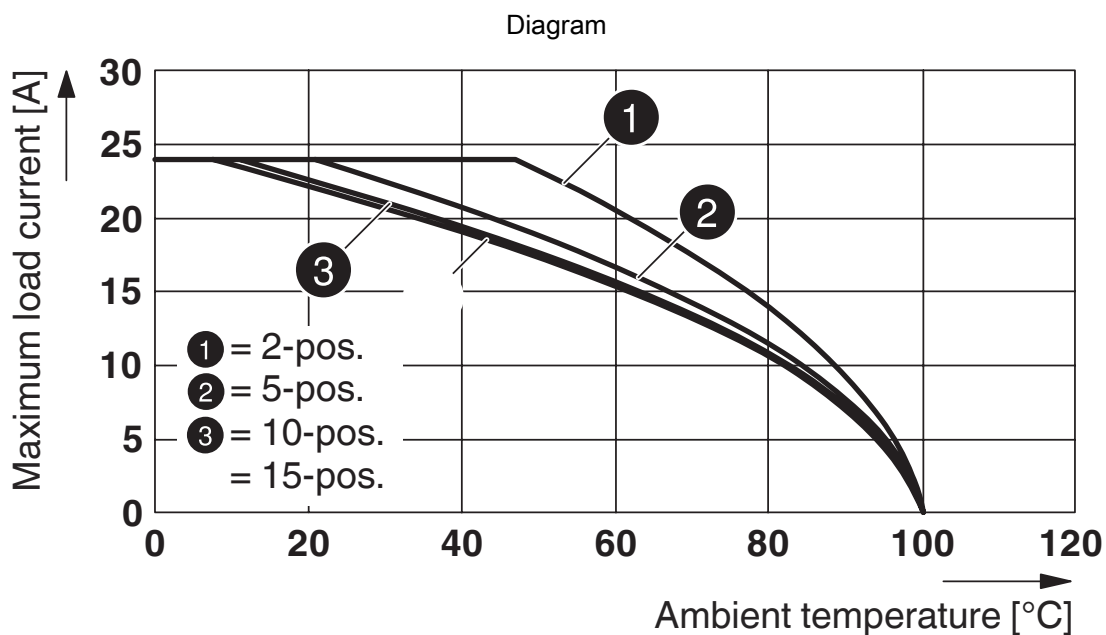

Derating curve for ST 2,5/ 1P, ST 2,5/ 2P, ST 2,5-TWIN/ 1P and for all plug versions SP... .

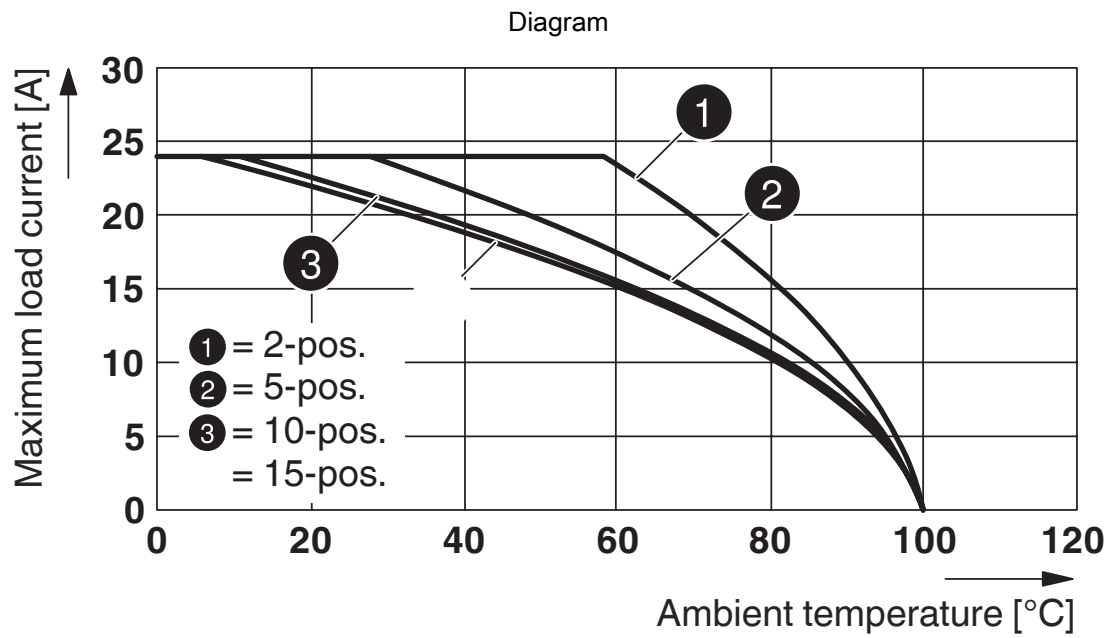

Derating curve for ST 2,5-QUATTRO/2P, ST 2,5-QUATTRO/4P and for all plug versions SP... .

SP 2,5/ 1-R GNYE - Plug

3043093

<https://www.phoenixcontact.com/us/products/3043093>



Schematic diagram

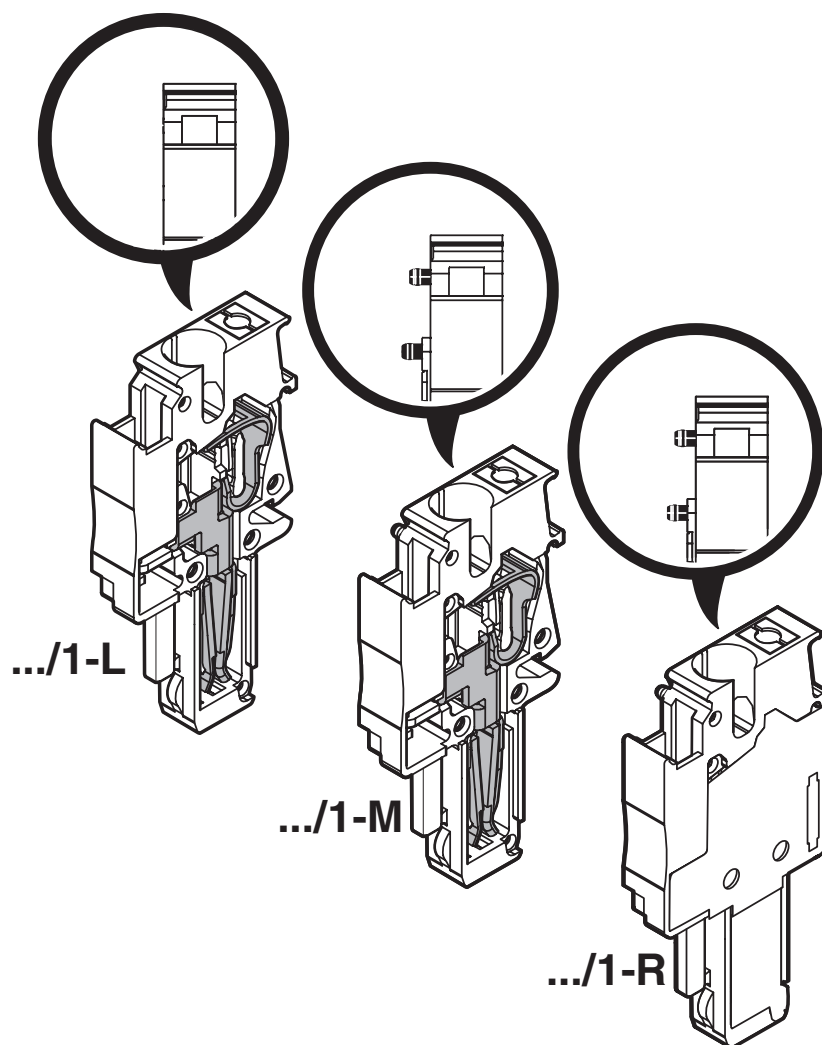

SP 2,5/ 1-R GNYE - Plug

3043093

<https://www.phoenixcontact.com/us/products/3043093>



Circuit diagram



SP 2,5/ 1-R GNYE - Plug



3043093

<https://www.phoenixcontact.com/us/products/3043093>

Approvals

To download certificates, visit the product detail page: <https://www.phoenixcontact.com/us/products/3043093>

 CSA Approval ID: 13631				
	Nominal voltage U_N	Nominal current I_N	Cross section AWG	Cross section mm^2
Use group B	300 V	20 A	28 - 12	-
Use group C	300 V	20 A	28 - 12	-
Use group D	600 V	5 A	28 - 12	-

 IECEE CB Scheme Approval ID: DE1-62736/B1/B2				
--	--	--	--	--

 EAC Approval ID: RU C-DE.BL08.B.00511				
---	--	--	--	--

 LR Approval ID: LR2042068TA				
---	--	--	--	--

 BV Approval ID: 27721/B0 BV				
---	--	--	--	--

 VDE Zeichengenehmigung Approval ID: 40019518				
	Nominal voltage U_N	Nominal current I_N	Cross section AWG	Cross section mm^2
Only flexible conductors	500 V	-	-	0.2 - 2.5
Only rigid conductors	500 V	-	-	0.2 - 4

 cULus Recognized Approval ID: E60425				
--	--	--	--	--

 cULus Recognized Approval ID: E60425				
--	--	--	--	--

SP 2,5/ 1-R GNYE - Plug

3043093

<https://www.phoenixcontact.com/us/products/3043093>



DNV

Approval ID: TAE00001CS

SP 2,5/ 1-R GNYE - Plug

3043093

<https://www.phoenixcontact.com/us/products/3043093>



Classifications

ECLASS

ECLASS-11.0	27141151
ECLASS-12.0	27141151
ECLASS-13.0	27250306

ETIM

ETIM 9.0	EC002021
----------	----------

UNSPSC

UNSPSC 21.0	39121400
-------------	----------

SP 2,5/ 1-R GNYE - Plug

3043093

<https://www.phoenixcontact.com/us/products/3043093>



Environmental product compliance

EU RoHS

Fulfills EU RoHS substance requirements	Yes, No exemptions
---	--------------------

China RoHS

Environment friendly use period (EFUP)	EFUP-E
	No hazardous substances above the limits

EU REACH SVHC

REACH candidate substance (CAS No.)	No substance above 0.1 wt%
-------------------------------------	----------------------------

SP 2,5/ 1-R GNYE - Plug

3043093

<https://www.phoenixcontact.com/us/products/3043093>



Accessories

PZ/2 - Strain relief

3040627

<https://www.phoenixcontact.com/us/products/3040627>



Strain relief, width: 9.3 mm, height: 48.7 mm, number of positions: 2, color: black

PZ/4 - Strain relief

3040643

<https://www.phoenixcontact.com/us/products/3040643>



Strain relief, width: 19.6 mm, height: 48.7 mm, number of positions: 4, color: black

SP 2,5/ 1-R GNYE - Plug

3043093

<https://www.phoenixcontact.com/us/products/3043093>



PR - Latching

3040559

<https://www.phoenixcontact.com/us/products/3040559>



Latching, width: 4.4 mm, height: 29.8 mm, number of positions: 1, color: orange

PR/2 - Latching

3040630

<https://www.phoenixcontact.com/us/products/3040630>



Latching, width: 10 mm, height: 29.8 mm, number of positions: 2, color: orange

SP 2,5/ 1-R GNYE - Plug

3043093

<https://www.phoenixcontact.com/us/products/3043093>



PRT/2 - Latching

3040631

<https://www.phoenixcontact.com/us/products/3040631>



Latching, can only be released using a screwdriver, width: 9 mm, height: 23.2 mm, number of positions: 2, color: orange

PRZ - Latching

3040614

<https://www.phoenixcontact.com/us/products/3040614>



Latching, number of positions: 2, length: 64 mm, color: orange

SP 2,5/ 1-R GNYE - Plug

3043093

<https://www.phoenixcontact.com/us/products/3043093>



SP 2,5/ 1-L - Plug

3043019

<https://www.phoenixcontact.com/us/products/3043019>



Plug, nom. voltage: 500 V, nominal current: 24 A, number of positions: 1, connection method: Spring-cage connection, Rated cross section: 2.5 mm², cross section: 0.08 mm²- 4 mm², color: gray

SP 2,5/ 1-L BU - Plug

3043022

<https://www.phoenixcontact.com/us/products/3043022>



Plug, nom. voltage: 500 V, nominal current: 24 A, number of positions: 1, connection method: Spring-cage connection, Rated cross section: 2.5 mm², cross section: 0.08 mm²- 4 mm², color: blue

SP 2,5/ 1-R GNYE - Plug

3043093

<https://www.phoenixcontact.com/us/products/3043093>



SP 2,5/ 1-L GNYE - Plug

3043035

<https://www.phoenixcontact.com/us/products/3043035>



Plug, nom. voltage: 500 V, nominal current: 24 A, number of positions: 1, connection method: Spring-cage connection, Rated cross section: 2.5 mm², cross section: 0.08 mm²- 4 mm², color: green-yellow

SP 2,5/ 1-M - Plug

3043043

<https://www.phoenixcontact.com/us/products/3043043>



Plug, nom. voltage: 500 V, nominal current: 24 A, number of positions: 1, connection method: Spring-cage connection, Rated cross section: 2.5 mm², cross section: 0.08 mm²- 4 mm², color: gray

SP 2,5/ 1-R GNYE - Plug

3043093

<https://www.phoenixcontact.com/us/products/3043093>



SP 2,5/ 1-M BU - Plug

3043051

<https://www.phoenixcontact.com/us/products/3043051>



Plug, nom. voltage: 500 V, nominal current: 24 A, number of positions: 1, connection method: Spring-cage connection, Rated cross section: 2.5 mm², cross section: 0.08 mm²- 4 mm², color: blue

SP 2,5/ 1-M GNYE - Plug

3043064

<https://www.phoenixcontact.com/us/products/3043064>



Plug, nom. voltage: 500 V, nominal current: 24 A, number of positions: 1, connection method: Spring-cage connection, Rated cross section: 2.5 mm², cross section: 0.08 mm²- 4 mm², color: green-yellow

SP 2,5/ 1-R GNYE - Plug

3043093

<https://www.phoenixcontact.com/us/products/3043093>



ZBF 5:UNBEDRUCKT - Zack Marker strip, flat

0808642

<https://www.phoenixcontact.com/us/products/0808642>



Zack Marker strip, flat, Strip, white, unlabeled, can be labeled with: PLOTMARK, CMS-P1-PLOTTER, mounting type: snapped, for terminal block width: 5 mm, lettering field size: 5.1 x 5.2 mm, Number of individual labels: 10

ZBF 5 CUS - Zack Marker strip, flat

0825025

<https://www.phoenixcontact.com/us/products/0825025>



Zack Marker strip, flat, can be ordered: Strip, white, labeled according to customer specifications, mounting type: snap into flat marker groove, for terminal block width: 5 mm, lettering field size: 5.15 x 5.15 mm, Number of individual labels: 10

SP 2,5/ 1-R GNYE - Plug

3043093

<https://www.phoenixcontact.com/us/products/3043093>



ZBF 5,LGS:FORTL.ZAHLEN - Zack Marker strip, flat

0808671

<https://www.phoenixcontact.com/us/products/0808671>



Zack Marker strip, flat, Strip, white, labeled, printed horizontally: consecutive numbers 1 ... 10, 11 ... 20, etc. up to 491 ... 500, mounting type: snapped, for terminal block width: 5 mm, lettering field size: 5.15 x 5.15 mm, Number of individual labels: 10

ZBF 5,QR:FORTL.ZAHLEN - Zack Marker strip, flat

0808697

<https://www.phoenixcontact.com/us/products/0808697>



Zack Marker strip, flat, Strip, white, labeled, Printed vertically: consecutive numbers 1 ... 10, 11 ... 20, etc. up to 91 ... 100, mounting type: snapped, for terminal block width: 5 mm, lettering field size: 5.15 x 5.15 mm, Number of individual labels: 10

SP 2,5/ 1-R GNYE - Plug

3043093

<https://www.phoenixcontact.com/us/products/3043093>



ZBF 5,LGS:GERADE ZAHLEN - Zack Marker strip, flat

0810821

<https://www.phoenixcontact.com/us/products/0810821>



Zack Marker strip, flat, Strip, white, labeled, printed horizontally: consecutive even numbers 2 ... 20, 22 ... 40, etc. up to 82 ... 100, mounting type: snapped, for terminal block width: 5 mm, lettering field size: 5.15 x 5.15 mm, Number of individual labels: 10

ZBF 5,LGS:UNGERADE ZAHLEN - Zack Marker strip, flat

0810863

<https://www.phoenixcontact.com/us/products/0810863>



Zack Marker strip, flat, Strip, white, labeled, printed horizontally: Odd numbers 1 - 19, 21 - 39, etc. up to 81 - 99, mounting type: snapped, for terminal block width: 5 mm, lettering field size: 5.15 x 5.15 mm, Number of individual labels: 10

SP 2,5/ 1-R GNYE - Plug

3043093

<https://www.phoenixcontact.com/us/products/3043093>



UC-TMF 5 - Marker for terminal blocks

0818153

<https://www.phoenixcontact.com/us/products/0818153>



Marker for terminal blocks, Sheet, white, unlabeled, can be labeled with: BLUEMARK ID COLOR, BLUEMARK ID, BLUEMARK CLED, PLOTMARK, CMS-P1-PLOTTER, mounting type: snapped, for terminal block width: 5.2 mm, lettering field size: 4.6 x 5.1 mm, Number of individual labels: 96

UC-TMF 5 CUS - Marker for terminal blocks

0824638

<https://www.phoenixcontact.com/us/products/0824638>

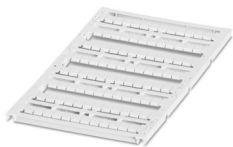

Marker for terminal blocks, can be ordered: by sheet, white, labeled according to customer specifications, mounting type: snap into flat marker groove, for terminal block width: 5.2 mm, lettering field size: 4.6 x 5.1 mm, Number of individual labels: 96

SP 2,5/ 1-R GNYE - Plug

3043093

<https://www.phoenixcontact.com/us/products/3043093>



UCT-TMF 5 - Marker for terminal blocks

0828744

<https://www.phoenixcontact.com/us/products/0828744>



Marker for terminal blocks, Sheet, white, unlabeled, can be labeled with: TOPMARK NEO, TOPMARK LASER, BLUEMARK ID COLOR, BLUEMARK ID, BLUEMARK CLED, THERMOMARK PRIME, THERMOMARK CARD 2.0, THERMOMARK CARD, mounting type: snapped, for terminal block width: 5.2 mm, lettering field size: 4.4 x 4.7 mm, Number of individual labels: 72

UCT-TMF 5 CUS - Marker for terminal blocks

0829658

<https://www.phoenixcontact.com/us/products/0829658>



Marker for terminal blocks, can be ordered: by sheet, white, labeled according to customer specifications, mounting type: snap into flat marker groove, for terminal block width: 5.2 mm, lettering field size: 4.4 x 4.7 mm, Number of individual labels: 72

SP 2,5/ 1-R GNYE - Plug

3043093

<https://www.phoenixcontact.com/us/products/3043093>



B-STIFT - Marker pen

1051993

<https://www.phoenixcontact.com/us/products/1051993>



Marker pen, for manual labeling of unprinted Zack strips, smear-proof and waterproof, line thickness 0.5 mm

X-PEN 0,35 - Marker pen

0811228

<https://www.phoenixcontact.com/us/products/0811228>



Marker pen without ink cartridge, for manual labeling of markers, labeling extremely wipe-proof, line thickness 0.35 mm

SP 2,5/ 1-R GNYE - Plug

3043093

<https://www.phoenixcontact.com/us/products/3043093>



ST-BW - Actuation tool

1207608

<https://www.phoenixcontact.com/us/products/1207608>

Actuation tool, for all 2.5 mm² - 4.0 mm² spring-cages



Phoenix Contact 2024 © - all rights reserved

<https://www.phoenixcontact.com>

Phoenix Contact USA
586 Fulling Mill Road
Middletown, PA 17057, United States
(+717) 944-1300
info@phoenixcon.com