

# FMC 1,5/10-STF-3,5 - PCB connectors



1966172

<https://www.phoenixcontact.com/us/products/1966172>

Please be informed that the data shown in this PDF document is generated from our online catalog. Please find the complete data in the user documentation. Our general terms of use for downloads are valid.

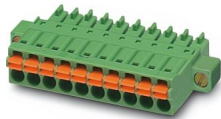

PCB connector, nominal cross section: 1.5 mm<sup>2</sup>, color: green, nominal current: 8 A, rated voltage (III/2): 160 V, contact surface: Tin, contact connection type: Socket, number of potentials: 10, number of rows: 1, number of positions: 10, number of connections: 10, product range: FMC 1,5/..-STF, pitch: 3.5 mm, connection method: Push-in spring connection, conductor/PCB connection direction: 0 °, plug-in system: COMBICON MC 1,5, locking: Screw locking mechanism, mounting: Screw flange, type of packaging: packed in cardboard

## Your advantages

- Time saving push-in connection, tools not required
- Defined contact force ensures that contact remains stable over the long term
- Intuitive operation due to color-coded actuating push button
- Operation and conductor connection from one direction enable integration into front of device
- Screwable flange for superior mechanical stability

## Commercial data

Item number	1966172
Packing unit	50 pc
Minimum order quantity	50 pc
Sales key	AA02
Product key	AABFAB
Catalog page	Page 201 (C-1-2013)
GTIN	4017918943363
Weight per piece (including packing)	6.516 g
Weight per piece (excluding packing)	6.16 g
Customs tariff number	85366990
Country of origin	DE

# FMC 1,5/10-STF-3,5 - PCB connectors



1966172

<https://www.phoenixcontact.com/us/products/1966172>

## Technical data

### Product properties

Product type	PCB connector
Product family	FMC 1,5/..-STF
Product line	COMBICON Connectors S
Type	Standard
Number of positions	10
Pitch	3.5 mm
Number of connections	10
Number of rows	1
Number of potentials	10
Mounting flange	Screw flange

### Electrical properties

Nominal current $I_N$	8 A
Nominal voltage $U_N$	160 V
Degree of pollution	3
Contact resistance	1.6 m $\Omega$
Rated voltage (III/3)	160 V
Rated surge voltage (III/3)	2.5 kV
Rated voltage (III/2)	160 V
Rated surge voltage (III/2)	2.5 kV
Rated voltage (II/2)	320 V
Rated surge voltage (II/2)	2.5 kV

### Connection data

#### Connection technology

Type	Standard
Connector system	COMBICON MC 1,5
Nominal cross section	1.5 mm <sup>2</sup>
Contact connection type	Socket

#### Interlock

Locking type	Screw locking mechanism
Mounting flange	Screw flange
Tightening torque	0.3 Nm

#### Conductor connection

Connection method	Push-in spring connection
Conductor/PCB connection direction	0 °
Conductor cross section rigid	0.2 mm <sup>2</sup> ... 1.5 mm <sup>2</sup>
Conductor cross section flexible	0.2 mm <sup>2</sup> ... 1.5 mm <sup>2</sup>
Conductor cross section AWG	24 ... 16

# FMC 1,5/10-STF-3,5 - PCB connectors



1966172

<https://www.phoenixcontact.com/us/products/1966172>

Conductor cross section flexible, with ferrule without plastic sleeve	0.25 mm <sup>2</sup> ... 1.5 mm <sup>2</sup>
Conductor cross section, flexible, with ferrule, with plastic sleeve	0.14 mm <sup>2</sup> ... 0.75 mm <sup>2</sup>
Cylindrical gauge a x b / diameter	2.4 mm x 1.5 mm / 1.6 mm
Stripping length	10 mm

## Specifications for ferrules without insulating collar

recommended crimping tool	1212034 CRIMPFOX 6
ferrules without insulating collar, according to DIN 46228-1	Cross section: 0.25 mm <sup>2</sup> ; Length: 7 mm
	Cross section: 0.34 mm <sup>2</sup> ; Length: 7 mm
	Cross section: 0.5 mm <sup>2</sup> ; Length: 8 mm ... 10 mm
	Cross section: 0.75 mm <sup>2</sup> ; Length: 8 mm ... 10 mm
	Cross section: 1 mm <sup>2</sup> ; Length: 8 mm ... 10 mm
	Cross section: 1.5 mm <sup>2</sup> ; Length: 10 mm

## Specifications for ferrules with insulating collar

recommended crimping tool	1212034 CRIMPFOX 6
ferrules with insulating collar, according to DIN 46228-4	Cross section: 0.14 mm <sup>2</sup> ; Length: 8 mm
	Cross section: 0.25 mm <sup>2</sup> ; Length: 8 mm ... 10 mm
	Cross section: 0.34 mm <sup>2</sup> ; Length: 8 mm ... 10 mm
	Cross section: 0.5 mm <sup>2</sup> ; Length: 8 mm ... 10 mm
	Cross section: 0.75 mm <sup>2</sup> ; Length: 10 mm

## Material specifications

### Material data - contact

Note	WEEE/RoHS-compliant, free of whiskers according to IEC 60068-2-82/JEDEC JESD 201
Contact material	Cu alloy
Surface characteristics	hot-dip tin-plated
Metal surface terminal point (top layer)	Tin (4 - 8 µm Sn)
Metal surface contact area (top layer)	Tin (4 - 8 µm Sn)

### Material data - housing

Color (Housing)	green (6021)
Insulating material	PA
Insulating material group	I
CTI according to IEC 60112	600
Flammability rating according to UL 94	V0
Glow wire flammability index GWFI according to EN 60695-2-12	850
Glow wire ignition temperature GWIT according to EN 60695-2-13	775
Temperature for the ball pressure test according to EN 60695-10-2	125 °C

### Material data – actuating element

Color (Actuating element)	orange (2003)
---------------------------	---------------

# FMC 1,5/10-STF-3,5 - PCB connectors

1966172

<https://www.phoenixcontact.com/us/products/1966172>

Insulating material	PBT
Insulating material group	IIIa
CTI according to IEC 60112	275
Flammability rating according to UL 94	V0

## Dimensions

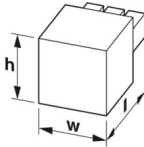
Dimensional drawing	
Pitch	3.5 mm
Width [w]	45.3 mm
Height [h]	7.8 mm
Length [l]	22.9 mm

## Mounting

Flange	
Tightening torque	0.3 Nm

## Mechanical tests

Conductor connection	
Specification	IEC 60999-1:1999-11
Result	Test passed

Test for conductor damage and slackening	
Specification	IEC 60999-1:1999-11
Result	Test passed

Repeated connection and disconnection	
Specification	IEC 60999-1:1999-11
Result	Test passed

Pull-out test	
Specification	IEC 60999-1:1999-11
Conductor cross section/conductor type/tractive force setpoint/actual value	0.2 mm <sup>2</sup> / solid / > 10 N
	0.2 mm <sup>2</sup> / flexible / > 10 N
	1.5 mm <sup>2</sup> / solid / > 40 N
	1.5 mm <sup>2</sup> / flexible / > 40 N

Insertion and withdrawal forces	
Result	Test passed
No. of cycles	25
Insertion strength per pos. approx.	9 N

# FMC 1,5/10-STF-3,5 - PCB connectors



1966172

<https://www.phoenixcontact.com/us/products/1966172>

Withdraw strength per pos. approx.	7 N
Resistance of inscriptions	
Specification	IEC 60068-2-70:1995-12
Result	Test passed
Polarization and coding	
Specification	IEC 60512-13-5:2006-02
Result	Test passed
Visual inspection	
Specification	IEC 60512-1-1:2002-02
Result	Test passed
Dimension check	
Specification	IEC 60512-1-2:2002-02
Result	Test passed

## Environmental and real-life conditions

### Vibration test

Specification	IEC 60068-2-6:2007-12
Frequency	10 - 150 - 10 Hz
Sweep speed	1 octave/min
Amplitude	0.35 mm (10 Hz ... 60.1 Hz)
Acceleration	5g (60.1 Hz ... 150 Hz)
Test duration per axis	2.5 h

### Durability test

Specification	IEC 60512-9-1:2010-03
Impulse withstand voltage at sea level	2.95 kV
Contact resistance $R_1$	1.6 m $\Omega$
Contact resistance $R_2$	1.7 m $\Omega$
Insertion/withdrawal cycles	25

### Climatic test

Specification	ISO 6988:1985-02
Corrosive stress	0.2 dm <sup>3</sup> SO <sub>2</sub> on 300 dm <sup>3</sup> /40 °C/1 cycle
Thermal stress	100 °C/168 h
Power-frequency withstand voltage	1.39 kV

### Shocks

Specification	IEC 60068-2-27:2008-02
Pulse shape	Semi-sinusoidal
Acceleration	30g
Shock duration	18 ms
Test directions	X-, Y- and Z-axis (pos. and neg.)

# FMC 1,5/10-STF-3,5 - PCB connectors



1966172

<https://www.phoenixcontact.com/us/products/1966172>

## Ambient conditions

Ambient temperature (operation)	-40 °C ... 100 °C (dependent on the derating curve)
Ambient temperature (storage/transport)	-40 °C ... 70 °C
Relative humidity (storage/transport)	30 % ... 70 %
Ambient temperature (assembly)	-5 °C ... 100 °C

## Electrical tests

### Thermal test | Test group C

Specification	IEC 60512-5-1:2002-02
Tested number of positions	20

### Insulation resistance

Specification	IEC 60512-3-1:2002-02
Insulation resistance, neighboring positions	> 5 MΩ

### Temperature cycles

Specification	IEC 60999-1:1999-11
Result	Test passed

### Air clearances and creepage distances |

Specification	IEC 60664-1:2007-04
Insulating material group	I
Comparative tracking index (IEC 60112)	CTI 600
Rated insulation voltage (III/3)	160 V
Rated surge voltage (III/3)	2.5 kV
minimum clearance value - non-homogenous field (III/3)	1.5 mm
minimum creepage distance (III/3)	2 mm
Rated insulation voltage (III/2)	160 V
Rated surge voltage (III/2)	2.5 kV
minimum clearance value - non-homogenous field (III/2)	1.5 mm
minimum creepage distance (III/2)	1.5 mm
Rated insulation voltage (II/2)	320 V
Rated surge voltage (II/2)	2.5 kV
minimum clearance value - non-homogenous field (II/2)	1.5 mm
minimum creepage distance (II/2)	1.6 mm

## Packaging specifications

Type of packaging	packed in cardboard
-------------------	---------------------

## Drawings

Diagram

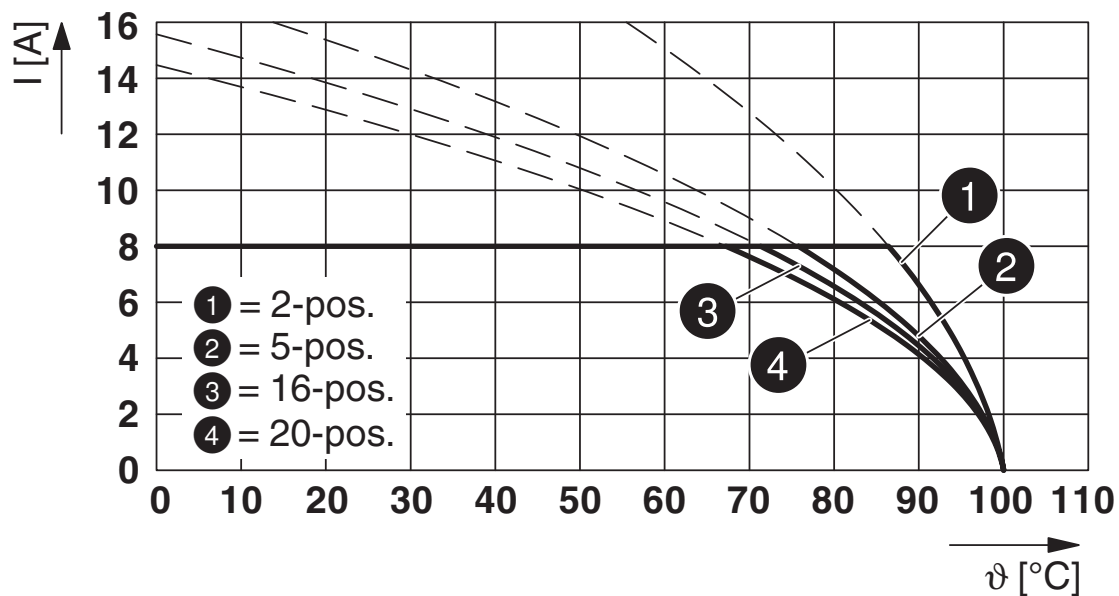

Type: FMC 1,5/...-STF-3,5 with MC 1,5/...-GF-3,5

Diagram

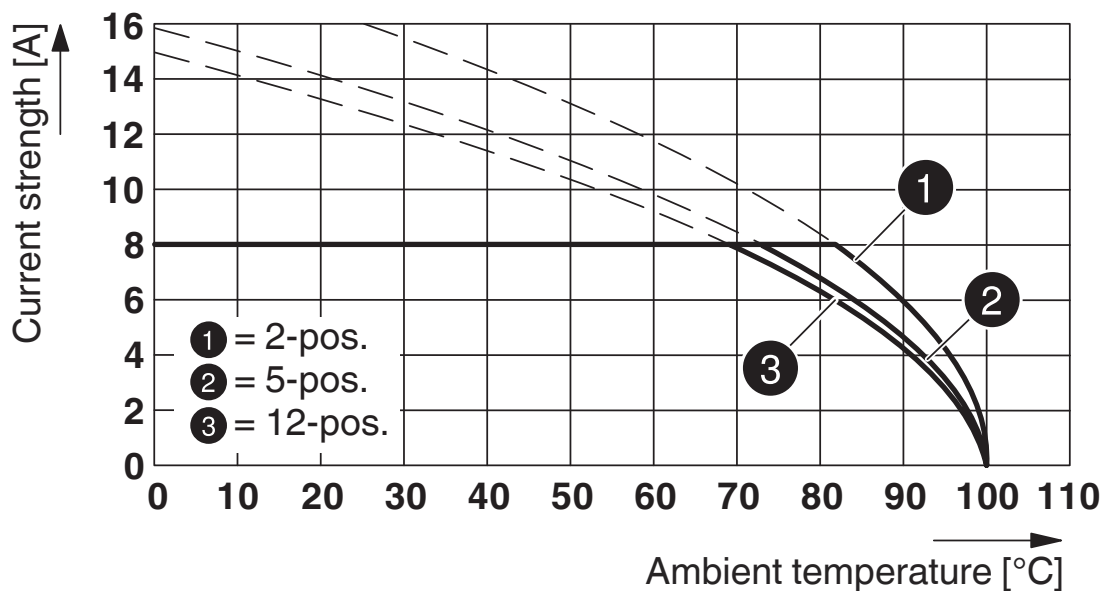

Type: FMC 1,5/...-STF-3,5 with MC 1,5/...-GF-3,5 P.. THR

# FMC 1,5/10-STF-3,5 - PCB connectors



1966172

<https://www.phoenixcontact.com/us/products/1966172>

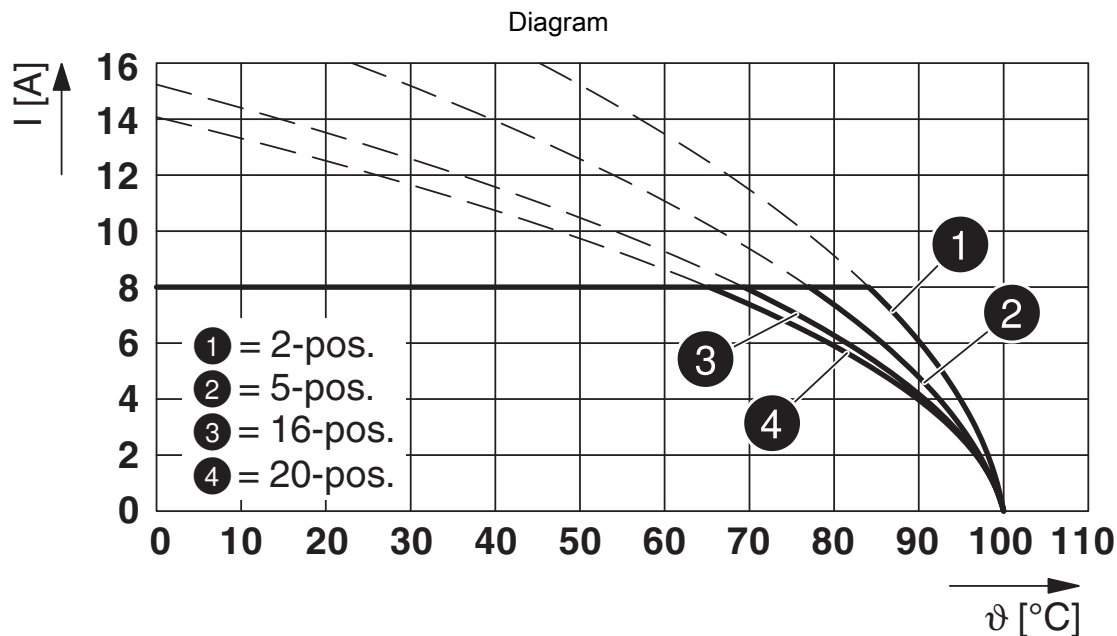

Type: FMC 1,5/...-STF-3,5 with MCV 1,5/...-GF-3,5

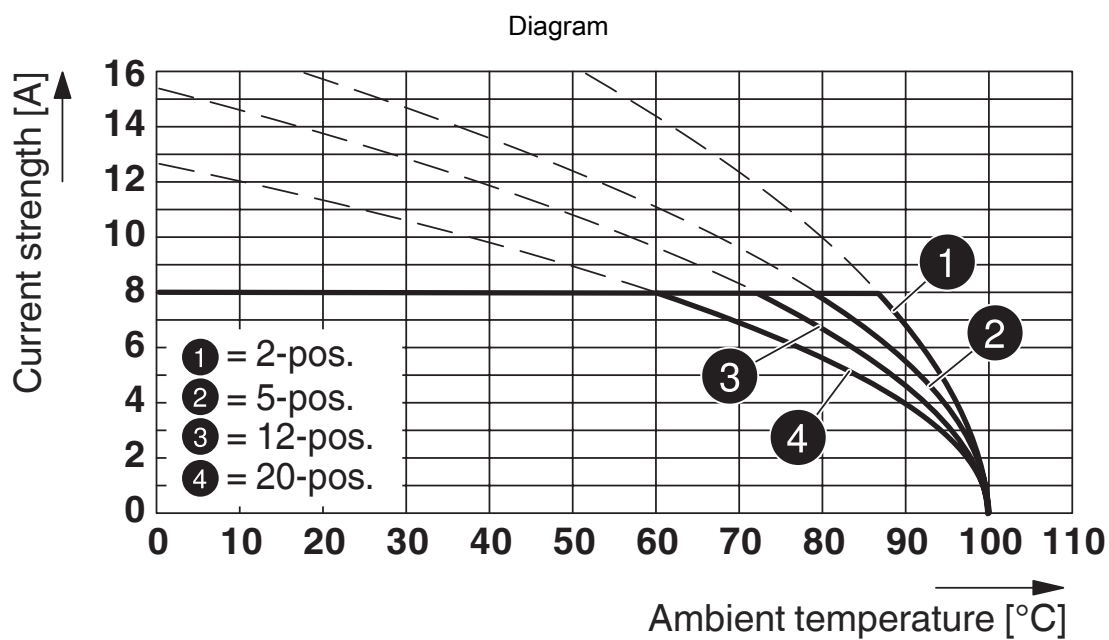

Type: FMC 1,5/...-STF-3,5 with MCV 1,5/...-GF-3,5 P... THR



# FMC 1,5/10-STF-3,5 - PCB connectors





1966172

<https://www.phoenixcontact.com/us/products/1966172>

## Approvals

To download certificates, visit the product detail page: <https://www.phoenixcontact.com/us/products/1966172>

 <b>cULus Recognized</b> Approval ID: E60425-19920306				
	Nominal voltage $U_N$	Nominal current $I_N$	Cross section AWG	Cross section $\text{mm}^2$
Use group B				
Field wiring	150 V	8 A	24 - 16	-
Use group C				
Factory wiring	50 V	8 A	24 - 16	-

 <b>VDE Zeichengenehmigung</b> Approval ID: 40011723				
	Nominal voltage $U_N$	Nominal current $I_N$	Cross section AWG	Cross section $\text{mm}^2$
	160 V	8 A	-	0.2 - 1.5

# FMC 1,5/10-STF-3,5 - PCB connectors



1966172

<https://www.phoenixcontact.com/us/products/1966172>

## Classifications

### ECLASS

ECLASS-11.0	27460202
ECLASS-12.0	27460202
ECLASS-13.0	27460202

### ETIM

ETIM 9.0	EC002638
----------	----------

### UNSPSC

UNSPSC 21.0	39121400
-------------	----------

# FMC 1,5/10-STF-3,5 - PCB connectors



1966172

<https://www.phoenixcontact.com/us/products/1966172>

## Environmental product compliance

### EU RoHS

Fulfills EU RoHS substance requirements	Yes, No exemptions
---	--------------------

### China RoHS

Environment friendly use period (EFUP)	EFUP-E
	No hazardous substances above the limits

### EU REACH SVHC

REACH candidate substance (CAS No.)	No substance above 0.1 wt%
-------------------------------------	----------------------------

# FMC 1,5/10-STF-3,5 - PCB connectors



1966172

<https://www.phoenixcontact.com/us/products/1966172>

## Accessories

### SK 3,5/2,8:FORTL.ZAHLEN - Marker card

0804073

<https://www.phoenixcontact.com/us/products/0804073>



Marker card, Sheet, white, labeled, horizontal: consecutive numbers 1 ... 10, 11 .. 20, etc. up to 91 ... 99, mounting type: adhesive, for terminal block width: 3.5 mm, lettering field size: 3.5 x 2.8 mm, Number of individual labels: 14

---

### B-STIFT - Marker pen

1051993

<https://www.phoenixcontact.com/us/products/1051993>



Marker pen, for manual labeling of unprinted Zack strips, smear-proof and waterproof, line thickness 0.5 mm

# FMC 1,5/10-STF-3,5 - PCB connectors

1966172

<https://www.phoenixcontact.com/us/products/1966172>

## CRIMPFOX 6 - Crimping pliers

1212034

<https://www.phoenixcontact.com/us/products/1212034>



Crimping pliers, for ferrules without insulating collar according to DIN 46228 Part 1 and ferrules with insulating collar according to DIN 46228 Part 4, 0.25 mm<sup>2</sup> ... 6.0 mm<sup>2</sup>, lateral entry, trapezoidal crimp

---

## SZS 0,4X2,5 VDE - Screwdriver

1205037

<https://www.phoenixcontact.com/us/products/1205037>



Screwdriver, slot-headed, VDE insulated, size: 0.4 x 2.5 x 80 mm, 2-component grip, with non-slip grip

# FMC 1,5/10-STF-3,5 - PCB connectors



1966172

<https://www.phoenixcontact.com/us/products/1966172>

## MCV 1,5/10-GF-3,5 P20 THRR72 - PCB header

1780820

<https://www.phoenixcontact.com/us/products/1780820>

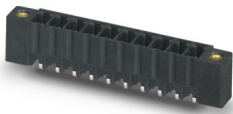

PCB headers, nominal cross section: 1.5 mm<sup>2</sup>, color: black, nominal current: 8 A, rated voltage (III/2): 160 V, contact surface: Tin, contact connection type: Pin, number of potentials: 10, number of rows: 1, number of positions: 10, number of connections: 10, product range: MCV 1,5/..-GF-THR, pitch: 3.5 mm, mounting: THR soldering, pin layout: Linear pinning, solder pin [P]: 2 mm, number of solder pins per potential: 1, plug-in system: COMBICON MC 1,5, Pin connector pattern alignment: Standard, locking: Screw locking mechanism, mounting: Threaded flange, type of packaging: 72 mm wide tape, For user information and design recommendations for through-hole reflow technology, go to: Downloads

## MC 1,5/10-GF-3,5 P26 THR - PCB header

1789326

<https://www.phoenixcontact.com/us/products/1789326>



PCB headers, nominal cross section: 1.5 mm<sup>2</sup>, color: black, nominal current: 8 A, rated voltage (III/2): 160 V, contact surface: Tin, contact connection type: Pin, number of potentials: 10, number of rows: 1, number of positions: 10, number of connections: 10, product range: MC 1,5/..-GF-THR, pitch: 3.5 mm, mounting: THR soldering, pin layout: Linear pinning, solder pin [P]: 2.6 mm, number of solder pins per potential: 1, plug-in system: COMBICON MC 1,5, Pin connector pattern alignment: Standard, locking: Screw locking mechanism, mounting: Threaded flange, type of packaging: packed in cardboard

# FMC 1,5/10-STF-3,5 - PCB connectors

1966172

<https://www.phoenixcontact.com/us/products/1966172>

## MC 1,5/10-GF-3,5 P26 THRR72 - PCB header

1789339

<https://www.phoenixcontact.com/us/products/1789339>



PCB headers, nominal cross section: 1.5 mm<sup>2</sup>, color: black, nominal current: 8 A, rated voltage (III/2): 160 V, contact surface: Tin, contact connection type: Pin, number of potentials: 10, number of rows: 1, number of positions: 10, number of connections: 10, product range: MC 1,5/..-GF-THR, pitch: 3.5 mm, mounting: THR soldering, pin layout: Linear pinning, solder pin [P]: 2.6 mm, number of solder pins per potential: 1, plug-in system: COMBICON MC 1,5, Pin connector pattern alignment: Standard, locking: Screw locking mechanism, mounting: Threaded flange, type of packaging: 72 mm wide tape

---

## MC 1,5/10-GF-3,5 P14 THRR72 - PCB header

1789779

<https://www.phoenixcontact.com/us/products/1789779>



PCB headers, nominal cross section: 1.5 mm<sup>2</sup>, color: black, nominal current: 8 A, rated voltage (III/2): 160 V, contact surface: Tin, contact connection type: Pin, number of potentials: 10, number of rows: 1, number of positions: 10, number of connections: 10, product range: MC 1,5/..-GF-THR, pitch: 3.5 mm, mounting: THR soldering, pin layout: Linear pinning, solder pin [P]: 1.4 mm, number of solder pins per potential: 1, plug-in system: COMBICON MC 1,5, Pin connector pattern alignment: Standard, locking: Screw locking mechanism, mounting: Threaded flange, type of packaging: 72 mm wide tape

# FMC 1,5/10-STF-3,5 - PCB connectors

1966172

<https://www.phoenixcontact.com/us/products/1966172>

## MCV 1,5/10-GF-3,5 - PCB header

1843305

<https://www.phoenixcontact.com/us/products/1843305>

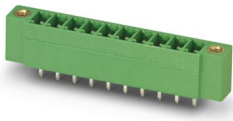

PCB headers, nominal cross section: 1.5 mm<sup>2</sup>, color: green, nominal current: 8 A, rated voltage (III/2): 160 V, contact surface: Tin, contact connection type: Pin, number of potentials: 10, number of rows: 1, number of positions: 10, number of connections: 10, product range: MCV 1,5/..-GF, pitch: 3.5 mm, mounting: Wave soldering, pin layout: Linear pinning, solder pin [P]: 3.4 mm, number of solder pins per potential: 1, plug-in system: COMBICON MC 1,5, Pin connector pattern alignment: Standard, locking: Screw locking mechanism, mounting: Threaded flange, type of packaging: packed in cardboard

---

## MC 1,5/10-GF-3,5 - PCB header

1843871

<https://www.phoenixcontact.com/us/products/1843871>

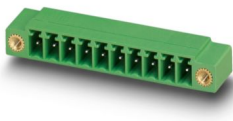

PCB headers, nominal cross section: 1.5 mm<sup>2</sup>, color: green, nominal current: 8 A, rated voltage (III/2): 160 V, contact surface: Tin, contact connection type: Pin, number of potentials: 10, number of rows: 1, number of positions: 10, number of connections: 10, product range: MC 1,5/..-GF, pitch: 3.5 mm, mounting: Wave soldering, pin layout: Linear pinning, solder pin [P]: 3.4 mm, number of solder pins per potential: 1, plug-in system: COMBICON MC 1,5, Pin connector pattern alignment: Standard, locking: Screw locking mechanism, mounting: Threaded flange, type of packaging: packed in cardboard



# FMC 1,5/10-STF-3,5 - PCB connectors



1966172

<https://www.phoenixcontact.com/us/products/1966172>

## MC 1,5/10-GF-3,5 P14 THR - PCB header

1789766

<https://www.phoenixcontact.com/us/products/1789766>



PCB headers, nominal cross section: 1.5 mm<sup>2</sup>, color: black, nominal current: 8 A, rated voltage (III/2): 160 V, contact surface: Tin, contact connection type: Pin, number of potentials: 10, number of rows: 1, number of positions: 10, number of connections: 10, product range: MC 1,5/..-GF-THR, pitch: 3.5 mm, mounting: THR soldering, pin layout: Linear pinning, solder pin [P]: 1.4 mm, number of solder pins per potential: 1, plug-in system: COMBICON MC 1,5, Pin connector pattern alignment: Standard, locking: Screw locking mechanism, mounting: Threaded flange, type of packaging: packed in cardboard

## MC 1,5/10-GF-3,5 P20 THR - PCB header

1789546

<https://www.phoenixcontact.com/us/products/1789546>



PCB headers, nominal cross section: 1.5 mm<sup>2</sup>, color: black, nominal current: 8 A, rated voltage (III/2): 160 V, contact surface: Tin, contact connection type: Pin, number of potentials: 10, number of rows: 1, number of positions: 10, number of connections: 10, product range: MC 1,5/..-GF-THR, pitch: 3.5 mm, mounting: THR soldering, pin layout: Linear pinning, solder pin [P]: 2 mm, number of solder pins per potential: 1, plug-in system: COMBICON MC 1,5, Pin connector pattern alignment: Standard, locking: Screw locking mechanism, mounting: Threaded flange, type of packaging: packed in cardboard

Phoenix Contact 2024 © - all rights reserved  
<https://www.phoenixcontact.com>

Phoenix Contact USA  
586 Fulling Mill Road  
Middletown, PA 17057, United States  
(+717) 944-1300  
[info@phoenixcon.com](mailto:info@phoenixcon.com)