

FKCVR 2,5/ 4-STF-5,08 - PCB connector



1874125

<https://www.phoenixcontact.com/us/products/1874125>

Please be informed that the data shown in this PDF document is generated from our online catalog. Please find the complete data in the user documentation. Our general terms of use for downloads are valid.

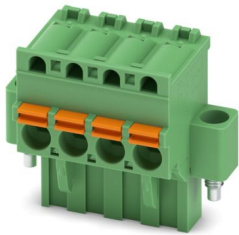

PCB connector, nominal cross section: 2.5 mm², color: green, nominal current: 12 A, rated voltage (III/2): 320 V, contact surface: Tin, contact connection type: Socket, number of potentials: 4, number of rows: 1, number of positions: 4, number of connections: 4, product range: FKCVR 2,5/..-STF, pitch: 5.08 mm, connection method: Push-in spring connection, conductor/PCB connection direction: 90 °, locking clip: - Locking clip, plug-in system: COMBICON MSTB 2,5, locking: Screw locking mechanism, mounting: Screw flange, type of packaging: packed in cardboard

Your advantages

- Time saving push-in connection, tools not required
- Intuitive operation due to color-coded actuating push button
- Quick and convenient testing using integrated test option
- Screwable flange for superior mechanical stability
- Can be combined with the MSTB 2,5 range

Commercial data

Item number	1874125
Packing unit	50 pc
Minimum order quantity	50 pc
Sales key	AA03
Product key	AACFIB
Catalog page	Page 281 (C-1-2013)
GTIN	4017918143510
Weight per piece (including packing)	8.5 g
Weight per piece (excluding packing)	7.919 g
Customs tariff number	85366990
Country of origin	SK

FKCVR 2,5/ 4-STF-5,08 - PCB connector



1874125

<https://www.phoenixcontact.com/us/products/1874125>

Technical data

Product properties

Product type	PCB connector
Product family	FKCVR 2,5/..-STF
Product line	COMBICON Connectors M
Type	Standard
Number of positions	4
Pitch	5.08 mm
Number of connections	4
Number of rows	1
Number of potentials	4
Mounting flange	Screw flange

Electrical properties

Nominal current I_N	12 A
Nominal voltage U_N	320 V
Contact resistance	2.3 m Ω
Rated voltage (III/3)	250 V
Rated surge voltage (III/3)	4 kV
Rated voltage (III/2)	320 V
Rated surge voltage (III/2)	4 kV
Rated voltage (II/2)	630 V
Rated surge voltage (II/2)	4 kV

Connection data

Connection technology

Type	Standard
Connector system	COMBICON MSTB 2,5
Nominal cross section	2.5 mm ²
Contact connection type	Socket

Interlock

Locking type	Screw locking mechanism
Mounting flange	Screw flange
Tightening torque	0.3 Nm

Conductor connection

Connection method	Push-in spring connection
Conductor/PCB connection direction	90 °
Conductor cross section rigid	0.2 mm ² ... 2.5 mm ²
Conductor cross section flexible	0.2 mm ² ... 2.5 mm ²
Conductor cross section AWG	24 ... 12
Conductor cross section flexible, with ferrule without plastic	0.25 mm ² ... 2.5 mm ²

FKCVR 2,5/ 4-STF-5,08 - PCB connector



1874125

<https://www.phoenixcontact.com/us/products/1874125>

sleeve	
Conductor cross section, flexible, with ferrule, with plastic sleeve	0.25 mm ² ... 2.5 mm ²
2 conductors with the same cross section, flexible, with TWIN ferrule with plastic sleeve	0.5 mm ² ... 1.5 mm ²
Cylindrical gauge a x b / diameter	2.8 mm x 2.0 mm / 2.0 mm
Stripping length	10 mm

Specifications for ferrules without insulating collar

recommended crimping tool	1212034 CRIMPFOX 6
---------------------------	--------------------

Material specifications

Material data - contact

Note	WEEE/RoHS-compliant, free of whiskers according to IEC 60068-2-82/JEDEC JESD 201
Contact material	Cu alloy
Surface characteristics	hot-dip tin-plated
Metal surface terminal point (top layer)	Tin (4 - 8 µm Sn)
Metal surface contact area (top layer)	Tin (4 - 8 µm Sn)

Material data - housing

Color (Housing)	green (6021)
Insulating material	PA
Insulating material group	I
CTI according to IEC 60112	600
Flammability rating according to UL 94	V0
Glow wire flammability index GWFI according to EN 60695-2-12	850
Glow wire ignition temperature GWIT according to EN 60695-2-13	775
Temperature for the ball pressure test according to EN 60695-10-2	125 °C

Material data – actuating element

Color (Actuating element)	orange (2003)
Insulating material	PBT
Insulating material group	I
CTI according to IEC 60112	600
Flammability rating according to UL 94	V0

Dimensions

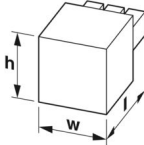
Dimensional drawing	
Pitch	5.08 mm

FKCVR 2,5/ 4-STF-5,08 - PCB connector



1874125

<https://www.phoenixcontact.com/us/products/1874125>

Width [w]	30.42 mm
Height [h]	16.8 mm
Length [l]	26.6 mm

Mounting

Flange

Tightening torque	0.3 Nm
-------------------	--------

Notes

Notes on operation	In accordance with IEC 61984, COMBICON connectors have no switching power (COC). During designated use, they must not be plugged in or disconnected when carrying voltage or under load.
--------------------	--

Mechanical tests

Conductor connection

Specification	IEC 60999-1:1999-11
Result	Test passed

Test for conductor damage and slackening

Specification	IEC 60999-1:1999-11
Result	Test passed

Repeated connection and disconnection

Specification	IEC 60999-1:1999-11
Result	Test passed

Pull-out test

Specification	IEC 60999-1:1999-11
Conductor cross section/conductor type/tractive force setpoint/actual value	0.2 mm ² / solid / > 10 N
	0.2 mm ² / flexible / > 10 N
	2.5 mm ² / solid / > 50 N
	2.5 mm ² / flexible / > 50 N

Insertion and withdrawal forces

Result	Test passed
No. of cycles	25
Insertion strength per pos. approx.	10 N
Withdraw strength per pos. approx.	8 N

Resistance of inscriptions

Specification	IEC 60068-2-70:1995-12
Result	Test passed

Polarization and coding

Specification	IEC 60512-13-5:2006-02
Result	Test passed

FKCVR 2,5/ 4-STF-5,08 - PCB connector



1874125

<https://www.phoenixcontact.com/us/products/1874125>

Visual inspection

Specification	IEC 60512-1-1:2002-02
Result	Test passed

Dimension check

Specification	IEC 60512-1-2:2002-02
Result	Test passed

Environmental and real-life conditions

Vibration test

Specification	IEC 60068-2-6:2007-12
Frequency	10 - 150 - 10 Hz
Sweep speed	1 octave/min
Amplitude	0.35 mm (10 Hz ... 60.1 Hz)
Acceleration	5g (60.1 Hz ... 150 Hz)
Test duration per axis	2.5 h

Durability test

Specification	IEC 60512-9-1:2010-03
Impulse withstand voltage at sea level	4.8 kV
Contact resistance R ₁	2.3 mΩ
Contact resistance R ₂	2.3 mΩ
Contact resistance R ₂ 2nd level	1.3 mΩ
Insertion/withdrawal cycles	25
Insulation resistance, neighboring positions	> 5 MΩ

Climatic test

Specification	ISO 6988:1985-02
Corrosive stress	0.2 dm ³ SO ₂ on 300 dm ³ /40 °C/1 cycle
Thermal stress	105 °C/168 h
Power-frequency withstand voltage	2.21 kV

Shocks

Specification	IEC 60068-2-27:2008-02
Pulse shape	Semi-sinusoidal
Acceleration	30g
Shock duration	18 ms
Test directions	X-, Y- and Z-axis (pos. and neg.)

Ambient conditions

Ambient temperature (operation)	-40 °C ... 105 °C (dependent on the derating curve)
Ambient temperature (storage/transport)	-40 °C ... 70 °C
Relative humidity (storage/transport)	30 % ... 70 %
Ambient temperature (assembly)	-5 °C ... 100 °C

FKCVR 2,5/ 4-STF-5,08 - PCB connector



1874125

<https://www.phoenixcontact.com/us/products/1874125>

Electrical tests

Thermal test | Test group C

Specification	IEC 60512-5-1:2002-02
Tested number of positions	16

Insulation resistance

Specification	IEC 60512-3-1:2002-02
Insulation resistance, neighboring positions	> 5 MΩ

Air clearances and creepage distances |

Specification	IEC 60664-1:2007-04
Insulating material group	I
Comparative tracking index (IEC 60112)	CTI 600
Rated insulation voltage (III/3)	250 V
Rated surge voltage (III/3)	4 kV
minimum clearance value - non-homogenous field (III/3)	3 mm
minimum creepage distance (III/3)	3.2 mm
Rated insulation voltage (III/2)	320 V
Rated surge voltage (III/2)	4 kV
minimum clearance value - non-homogenous field (III/2)	3 mm
minimum creepage distance (III/2)	1.6 mm
Rated insulation voltage (II/2)	630 V
Rated surge voltage (II/2)	4 kV
minimum clearance value - non-homogenous field (II/2)	3 mm
minimum creepage distance (II/2)	3.2 mm

Packaging specifications

Type of packaging	packed in cardboard
-------------------	---------------------

Drawings

Diagram

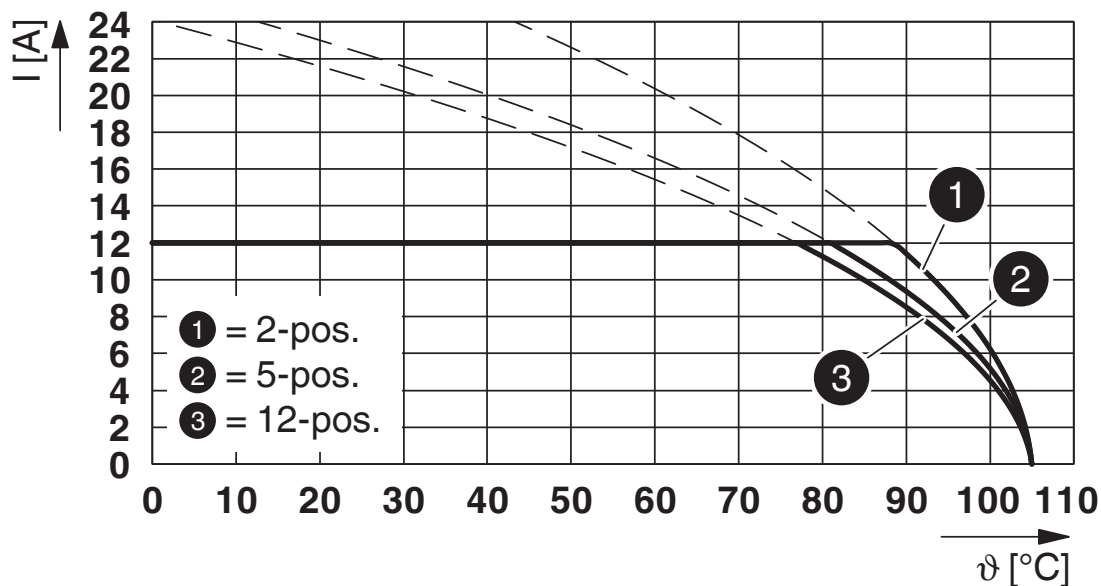

Type: FKCVR 2,5/...-STF-5,08 with CC 2,5/...-GF-5,08 P...THR

Diagram

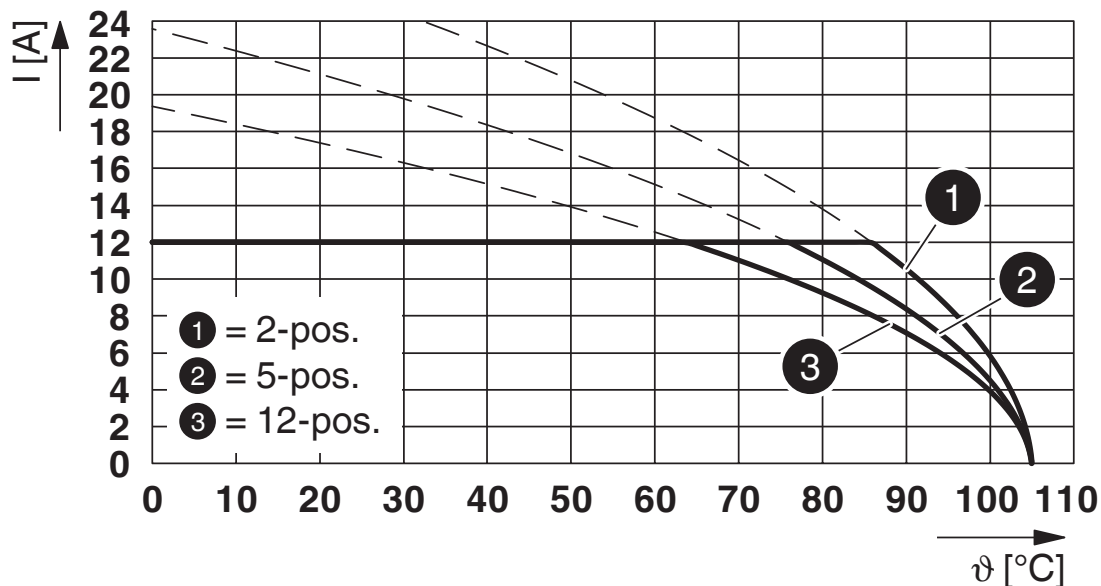

Type: FKCVR 2,5/...-STF-5,08 with CCV 2,5/...-GF-5,08-LR P...THR

1874125

<https://www.phoenixcontact.com/us/products/1874125>

Diagram

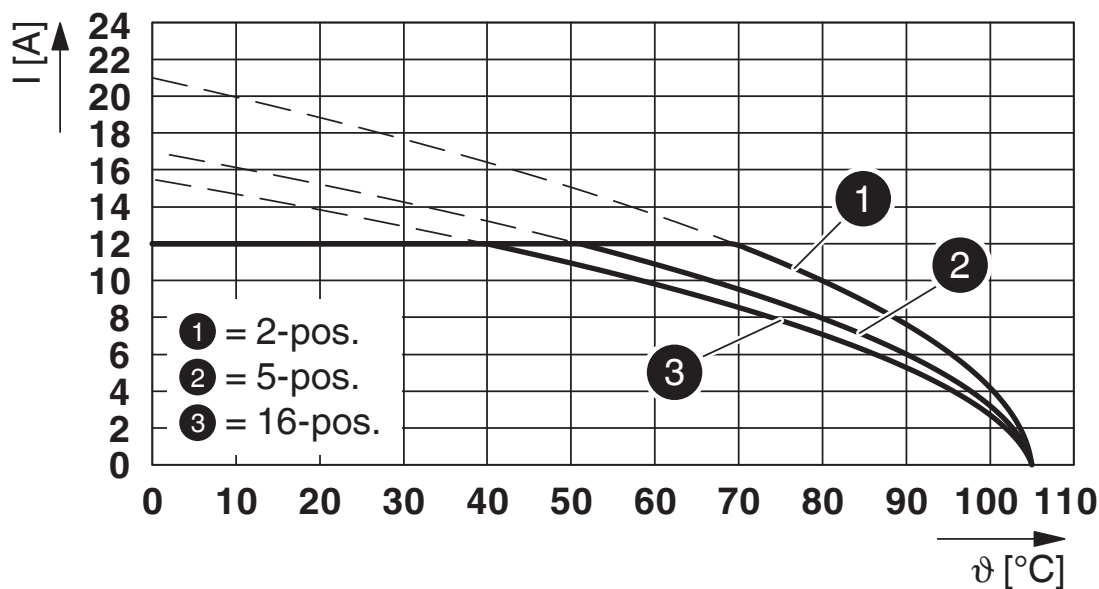

Type: FKCVR 2,5/...-STF-5,08 with MSTBV 2,5/...-GF-5,08

Diagram

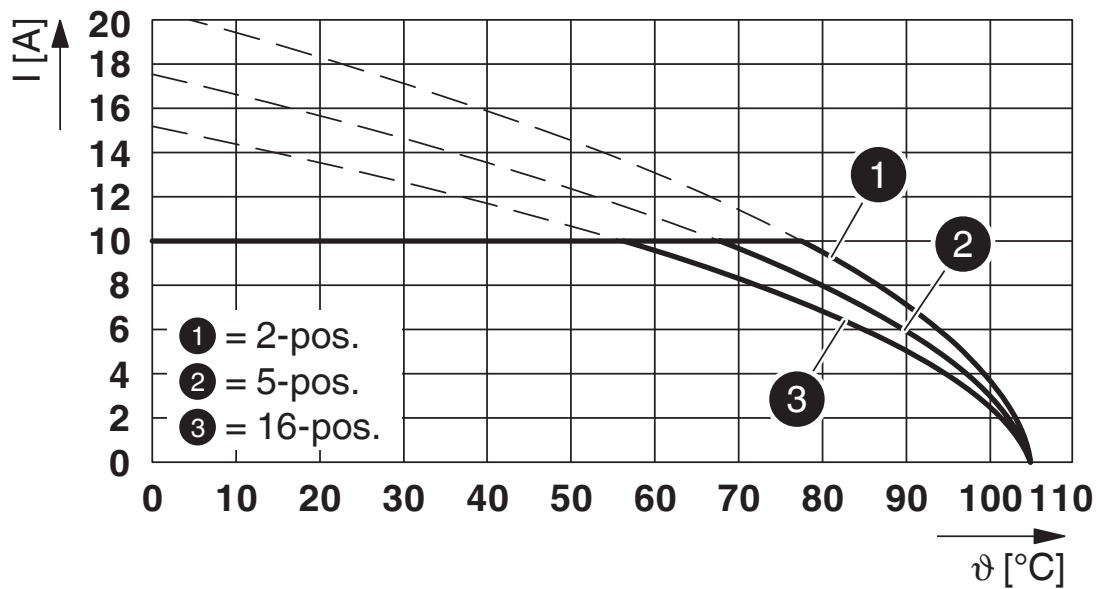

Type: FKCVR 2,5/...-STF-5,08 with MDSTBV 2,5/...-GF-5,08

FKCVR 2,5/ 4-STF-5,08 - PCB connector

1874125

<https://www.phoenixcontact.com/us/products/1874125>

Dimensional drawing

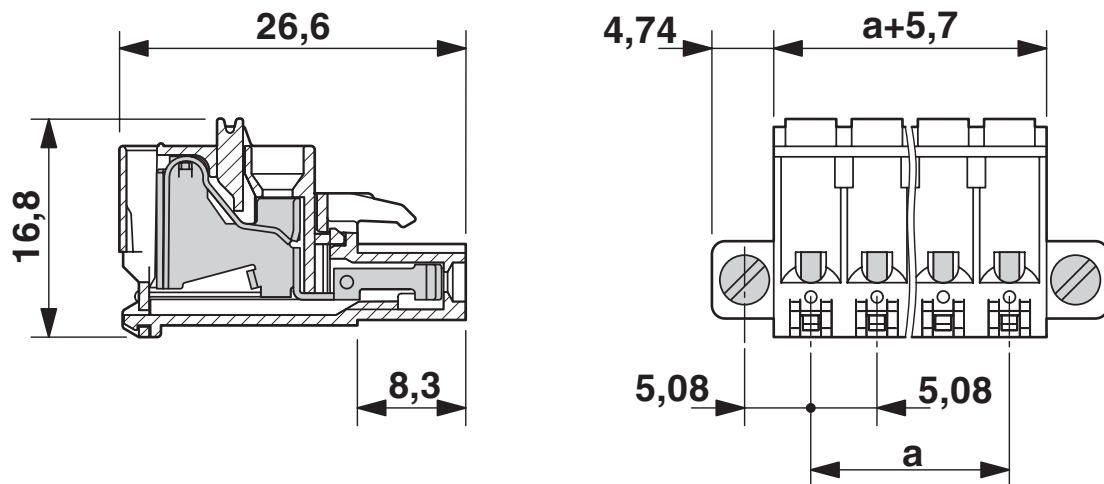

Diagram

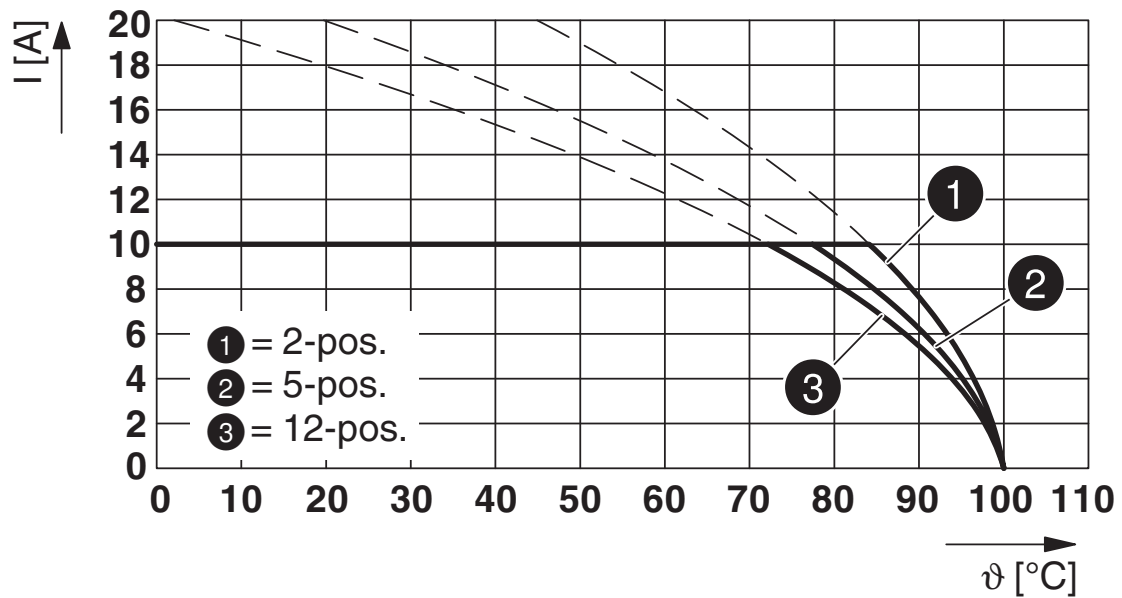

Type: FKCV(W/R) 2,5/...-STF-5,08 with MDSTB 2,5/...-GF-5,08

FKCVR 2,5/ 4-STF-5,08 - PCB connector



1874125

<https://www.phoenixcontact.com/us/products/1874125>

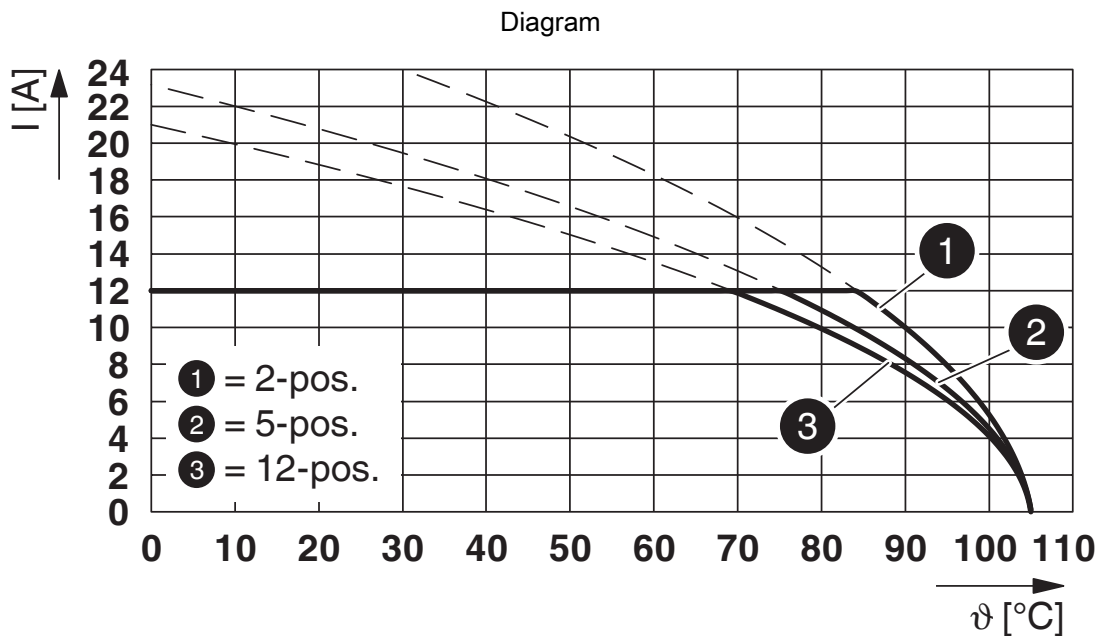

Type: FKCVR 2,5/...-STF-5,08 with CC 2,5/...-GF-5,08-LR P...THR

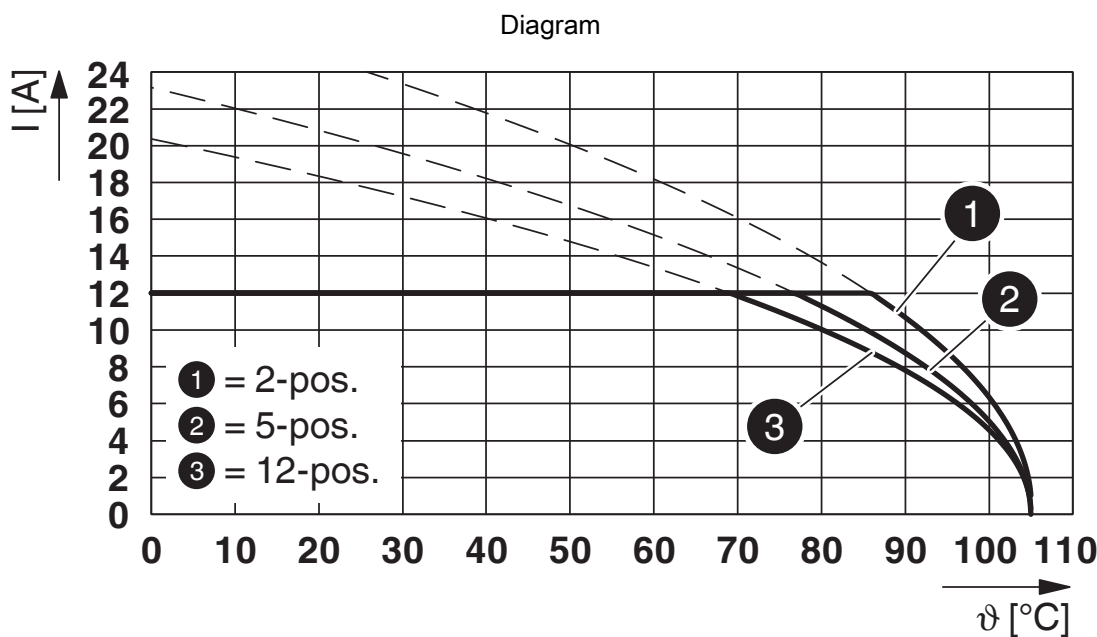

Type: FKCVR 2,5/...-STF-5,08 with MSTB 2,5/...-GF-5,08

1874125

<https://www.phoenixcontact.com/us/products/1874125>

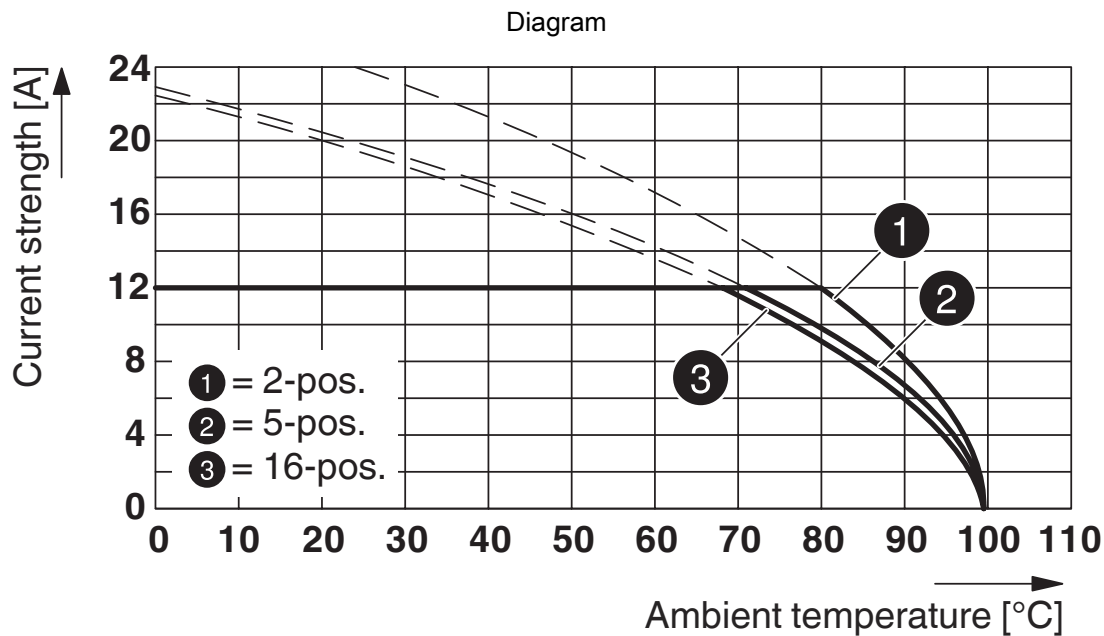

Type: FKCVR 2,5/...-STF-5,08 with DFK-MSTB 2,5/...-GF-5,08

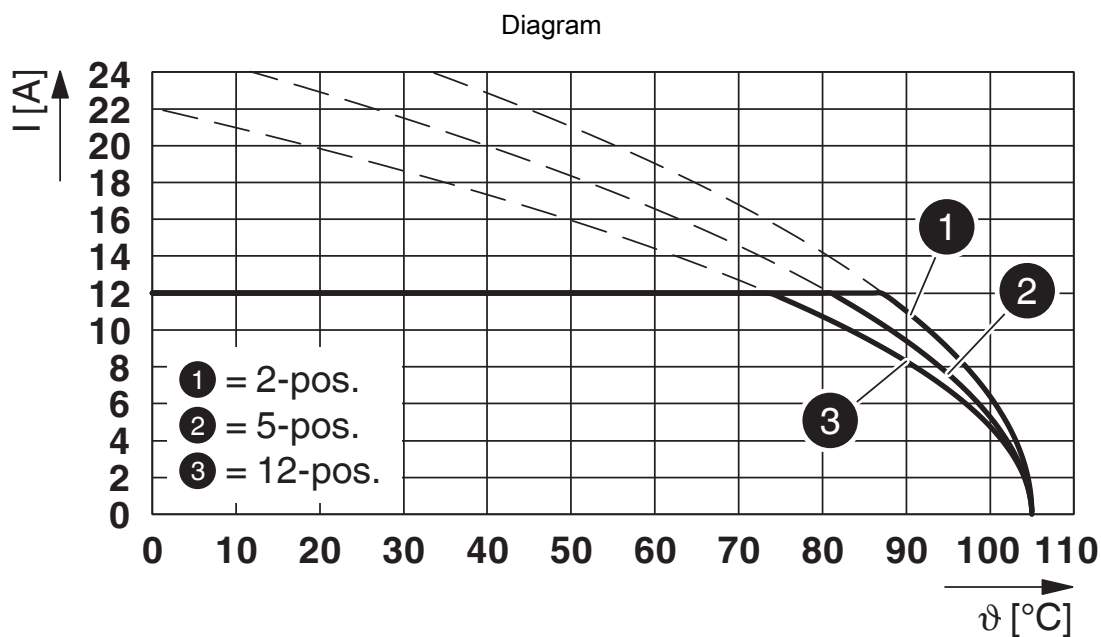

Type: FKCVR 2,5/...-STF-5,08 with CCV 2,5/...-GF-5,08 P...THR

FKCVR 2,5/ 4-STF-5,08 - PCB connector





1874125

<https://www.phoenixcontact.com/us/products/1874125>

Approvals

To download certificates, visit the product detail page: <https://www.phoenixcontact.com/us/products/1874125>

 cULus Recognized Approval ID: E60425-19931011				
	Nominal voltage U_N	Nominal current I_N	Cross section AWG	Cross section mm^2
Use group B	300 V	10 A	26 - 12	-
Use group D	300 V	10 A	26 - 12	-

 VDE Zeichengenehmigung Approval ID: 40050694				
	Nominal voltage U_N	Nominal current I_N	Cross section AWG	Cross section mm^2
	250 V	12 A	-	0.2 - 2.5

FKCVR 2,5/ 4-STF-5,08 - PCB connector



1874125

<https://www.phoenixcontact.com/us/products/1874125>

Classifications

ECLASS

ECLASS-11.0	27460202
ECLASS-12.0	27460202
ECLASS-13.0	27460202

ETIM

ETIM 9.0	EC002638
----------	----------

UNSPSC

UNSPSC 21.0	39121400
-------------	----------

FKCVR 2,5/ 4-STF-5,08 - PCB connector



1874125

<https://www.phoenixcontact.com/us/products/1874125>

Environmental product compliance

EU RoHS

Fulfills EU RoHS substance requirements	Yes, No exemptions
---	--------------------

China RoHS

Environment friendly use period (EFUP)	EFUP-E
	No hazardous substances above the limits

EU REACH SVHC

REACH candidate substance (CAS No.)	No substance above 0.1 wt%
-------------------------------------	----------------------------

FKCVR 2,5/ 4-STF-5,08 - PCB connector

1874125

<https://www.phoenixcontact.com/us/products/1874125>

Accessories

CP-MSTB - Coding profile

1734634

<https://www.phoenixcontact.com/us/products/1734634>

Coding profile, is inserted into the slot on the plug or inverted header, red insulating material



STZ 4-FKC-5,08 - Strain relief

1876877

<https://www.phoenixcontact.com/us/products/1876877>

Strain relief for snapping into the latching chambers of the plugs, 4-pos.



FKCVR 2,5/ 4-STF-5,08 - PCB connector



1874125

<https://www.phoenixcontact.com/us/products/1874125>

STZ 8-FKC-5,08 - Strain relief

1876880

<https://www.phoenixcontact.com/us/products/1876880>



Strain relief for snapping into the latching chambers of the plug components, 8-pos.

MPS-MT - Test plug

0201744

<https://www.phoenixcontact.com/us/products/0201744>



Test plug, with solder connection up to 1 mm² conductor cross section, number of positions: 1, color: gray

FKCVR 2,5/ 4-STF-5,08 - PCB connector

1874125

<https://www.phoenixcontact.com/us/products/1874125>



RPS - Reducing plug

0201647

<https://www.phoenixcontact.com/us/products/0201647>



Reducing plug, number of positions: 1, color: gray

SZS 0,6X3,5 - Screwdriver

1205053

<https://www.phoenixcontact.com/us/products/1205053>



Actuation tool, for ST terminal blocks, insulated, also suitable for use as a bladed screwdriver, size: 0.6 x 3.5 x 100 mm, 2-component grip, with non-slip grip

FKCVR 2,5/ 4-STF-5,08 - PCB connector



1874125

<https://www.phoenixcontact.com/us/products/1874125>

SK 5,08/3,8:FORTL.ZAHLEN - Marker card

0804293

<https://www.phoenixcontact.com/us/products/0804293>

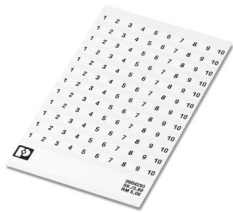

Marker card, white, labeled, horizontal: consecutive numbers 1 ... 10, 11 ... 20, etc. up to 91 ... (99)100, mounting type: adhesive, for terminal block width: 5.08 mm, lettering field size: 5.08 x 3.8 mm

MSTB 2,5/ 4-GF-5,08 - PCB header

1776524

<https://www.phoenixcontact.com/us/products/1776524>

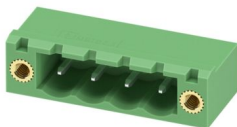

PCB headers, nominal cross section: 2.5 mm², color: green, nominal current: 12 A, rated voltage (III/2): 320 V, contact surface: Tin, contact connection type: Pin, number of potentials: 4, number of rows: 1, number of positions: 4, number of connections: 4, product range: MSTB 2,5/..-GF, pitch: 5.08 mm, mounting: Wave soldering, pin layout: Linear pinning, solder pin [P]: 3.23 mm, number of solder pins per potential: 1, plug-in system: COMBICON MSTB 2,5, Pin connector pattern alignment: Standard, locking: Screw locking mechanism, mounting: Threaded flange, type of packaging: packed in cardboard

FKCVR 2,5/ 4-STF-5,08 - PCB connector

1874125

<https://www.phoenixcontact.com/us/products/1874125>

MSTBV 2,5/ 4-GF-5,08 - PCB header

1777099

<https://www.phoenixcontact.com/us/products/1777099>

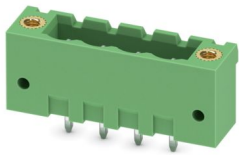

PCB headers, nominal cross section: 2.5 mm², color: green, nominal current: 12 A, rated voltage (III/2): 320 V, contact surface: Tin, contact connection type: Pin, number of potentials: 4, number of rows: 1, number of positions: 4, number of connections: 4, product range: MSTBV 2,5/...-GF, pitch: 5.08 mm, mounting: Wave soldering, pin layout: Linear pinning, solder pin [P]: 3.9 mm, number of solder pins per potential: 1, plug-in system: COMBICON MSTB 2,5, Pin connector pattern alignment: Standard, locking: Screw locking mechanism, mounting: Threaded flange, type of packaging: packed in cardboard

MDSTB 2,5/ 4-GF-5,08 - PCB header

1842380

<https://www.phoenixcontact.com/us/products/1842380>

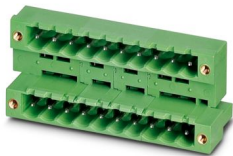

PCB headers, nominal cross section: 2.5 mm², color: green, nominal current: 10 A, rated voltage (III/2): 320 V, contact surface: Tin, contact connection type: Pin, number of potentials: 8, number of rows: 2, number of positions: 4, number of connections: 8, product range: MDSTB 2,5/...-GF, pitch: 5.08 mm, mounting: Wave soldering, pin layout: Linear pinning, solder pin [P]: 3.23 mm, number of solder pins per potential: 1, plug-in system: COMBICON MSTB 2,5, Pin connector pattern alignment: Standard, locking: Screw locking mechanism, mounting: Threaded flange, type of packaging: packed in cardboard, The article can be aligned to create different nos. of positions! In combination with MVSTB or FKCV plug components, both an MVSTBW (or FKCVW) and an MVSTBR plug (or FKCVR) must be used. Combination with TMSTBP plug components is not possible!

FKCVR 2,5/ 4-STF-5,08 - PCB connector

1874125

<https://www.phoenixcontact.com/us/products/1874125>

MDSTBV 2,5/ 4-GF-5,08 - PCB header

1845659

<https://www.phoenixcontact.com/us/products/1845659>

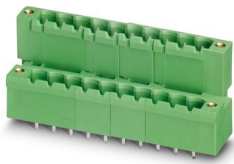

PCB headers, nominal cross section: 2.5 mm², color: green, nominal current: 10 A, rated voltage (III/2): 320 V, contact surface: Tin, contact connection type: Pin, number of potentials: 8, number of rows: 2, number of positions: 4, number of connections: 8, product range: MDSTBV 2,5/..-GF, pitch: 5.08 mm, mounting: Wave soldering, pin layout: Linear pinning, solder pin [P]: 3.9 mm, number of solder pins per potential: 1, plug-in system: COMBICON MSTB 2,5, Pin connector pattern alignment: Standard, locking: Screw locking mechanism, mounting: Threaded flange, type of packaging: packed in cardboard, The article can be aligned to create different nos. of positions! In combination with MVSTB or FKCV plug components, both an MVSTBW (or FKCVW) and an MVSTBR plug (or FKCVR) must be used. Combination with TMSTBP plug components is not possible!

DFK-MSTBA 2,5/ 4-GF-5,08 - Feed-through header

1899003

<https://www.phoenixcontact.com/us/products/1899003>



Feed-through header, nominal cross section: 2.5 mm², color: green, nominal current: 12 A, rated voltage (III/2): 320 V, contact surface: Tin, contact connection type: Pin, number of potentials: 4, number of rows: 1, number of positions: 4, number of connections: 4, product range: DFK-MSTBA 2,5/..-GF, pitch: 5.08 mm, mounting: Wave soldering, pin layout: Linear pinning, solder pin [P]: 3.23 mm, number of solder pins per potential: 1, plug-in system: COMBICON MSTB 2,5, Pin connector pattern alignment: Standard, locking: Screw locking mechanism, mounting: Threaded flange, type of packaging: packed in cardboard

FKCVR 2,5/ 4-STF-5,08 - PCB connector

1874125

<https://www.phoenixcontact.com/us/products/1874125>

DFK-MSTBVA 2,5/ 4-GF-5,08 - Feed-through header

1899304

<https://www.phoenixcontact.com/us/products/1899304>



Feed-through header, nominal cross section: 2.5 mm², color: green, nominal current: 12 A, rated voltage (III/2): 320 V, contact surface: Tin, contact connection type: Pin, number of potentials: 4, number of rows: 1, number of positions: 4, number of connections: 4, product range: DFK-MSTBVA 2,5/..-GF, pitch: 5.08 mm, mounting: Wave soldering, pin layout: Linear pinning, solder pin [P]: 3.9 mm, number of solder pins per potential: 1, plug-in system: COMBICON MSTB 2,5, Pin connector pattern alignment: Standard, locking: Screw locking mechanism, mounting: Threaded flange, type of packaging: packed in cardboard

CCV 2,5/ 4-GF-5,08 P26THR - PCB header

1955659

<https://www.phoenixcontact.com/us/products/1955659>



PCB headers, nominal cross section: 2.5 mm², color: black, nominal current: 12 A, rated voltage (III/2): 320 V, contact surface: Tin, contact connection type: Pin, number of potentials: 4, number of rows: 1, number of positions: 4, number of connections: 4, product range: CCV 2,5/..-GF, pitch: 5.08 mm, mounting: THR soldering / wave soldering, pin layout: Linear pinning, solder pin [P]: 2.6 mm, number of solder pins per potential: 1, plug-in system: COMBICON MSTB 2,5, Pin connector pattern alignment: Standard, locking: Screw locking mechanism, mounting: Threaded flange, type of packaging: packed in cardboard, For user information and design recommendations for through-hole reflow technology, go to: Downloads

FKCVR 2,5/ 4-STF-5,08 - PCB connector



1874125

<https://www.phoenixcontact.com/us/products/1874125>

CCV 2,5/ 4-GF-5,08 P26THRR56 - PCB header

1955769

<https://www.phoenixcontact.com/us/products/1955769>



PCB headers, nominal cross section: 2.5 mm², color: black, nominal current: 12 A, rated voltage (III/2): 320 V, contact surface: Tin, contact connection type: Pin, number of potentials: 4, number of rows: 1, number of positions: 4, number of connections: 4, product range: CCV 2,5/..-GF, pitch: 5.08 mm, mounting: THR soldering / wave soldering, pin layout: Linear pinning, solder pin [P]: 2.6 mm, number of solder pins per potential: 1, plug-in system: COMBICON MSTB 2,5, Pin connector pattern alignment: Standard, locking: Screw locking mechanism, mounting: Threaded flange, type of packaging: 56 mm wide tape, For user information and design recommendations for through-hole reflow technology, go to: Downloads

Phoenix Contact 2024 © - all rights reserved

<https://www.phoenixcontact.com>

Phoenix Contact USA

586 Fulling Mill Road

Middletown, PA 17057, United States

(+717) 944-1300

info@phoenixcon.com