

MC 1,5/ 6-ST-3,81 - PCB connector



1803617

<https://www.phoenixcontact.com/us/products/1803617>

Please be informed that the data shown in this PDF document is generated from our online catalog. Please find the complete data in the user documentation. Our general terms of use for downloads are valid.

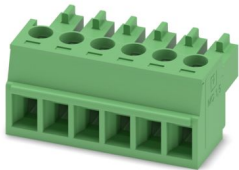

PCB connector, nominal cross section: 1.5 mm², color: green, nominal current: 8 A, rated voltage (III/2): 160 V, contact surface: Tin, contact connection type: Socket, number of potentials: 6, number of rows: 1, number of positions: 6, number of connections: 6, product range: MC 1,5/..-ST, pitch: 3.81 mm, connection method: Screw connection with tension sleeve, screw head form: L Slotted, conductor/PCB connection direction: 0 °, plug-in system: COMBICON MC 1,5, locking: without, mounting: without, type of packaging: packed in cardboard

Your advantages

- Well-known connection principle allows worldwide use
- Low temperature rise, thanks to maximum contact force
- Allows connection of two conductors

Commercial data

Item number	1803617
Packing unit	50 pc
Minimum order quantity	50 pc
Sales key	AA02
Product key	AABABA
Catalog page	Page 190 (C-1-2013)
GTIN	4017918045920
Weight per piece (including packing)	4.548 g
Weight per piece (excluding packing)	4.326 g
Customs tariff number	85366990
Country of origin	DE

MC 1,5/ 6-ST-3,81 - PCB connector



1803617

<https://www.phoenixcontact.com/us/products/1803617>

Technical data

Product properties

Product type	PCB connector
Product family	MC 1,5/...-ST
Product line	COMBICON Connectors S
Type	Standard
Number of positions	6
Pitch	3.81 mm
Number of connections	6
Number of rows	1
Number of potentials	6
Mounting flange	without

Electrical properties

Nominal current I_N	8 A
Nominal voltage U_N	160 V
Degree of pollution	3
Contact resistance	1.3 m Ω
Rated voltage (III/3)	160 V
Rated surge voltage (III/3)	2.5 kV
Rated voltage (III/2)	160 V
Rated surge voltage (III/2)	2.5 kV
Rated voltage (II/2)	320 V
Rated surge voltage (II/2)	2.5 kV

Connection data

Connection technology

Type	Standard
Connector system	COMBICON MC 1,5
Nominal cross section	1.5 mm ²
Contact connection type	Socket

Interlock

Locking type	without
Mounting flange	without

Conductor connection

Connection method	Screw connection with tension sleeve
Conductor/PCB connection direction	0 °
Conductor cross section rigid	0.14 mm ² ... 1.5 mm ²
Conductor cross section flexible	0.14 mm ² ... 1.5 mm ²
Conductor cross section AWG	28 ... 16
Conductor cross section flexible, with ferrule without plastic	0.25 mm ² ... 1.5 mm ²

MC 1,5/ 6-ST-3,81 - PCB connector

1803617

<https://www.phoenixcontact.com/us/products/1803617>

sleeve	
Conductor cross section, flexible, with ferrule, with plastic sleeve	0.25 mm ² ... 0.75 mm ²
2 conductors with same cross section, solid	0.08 mm ² ... 0.5 mm ²
2 conductors with same cross section, flexible	0.08 mm ² ... 0.75 mm ²
2 conductors with same cross section, flexible, with ferrule without plastic sleeve	0.25 mm ² ... 0.34 mm ²
2 conductors with the same cross section, flexible, with TWIN ferrule with plastic sleeve	0.5 mm ² ... 0.5 mm ²
Cylindrical gauge a x b / diameter	2.4 mm x 1.5 mm / 1.6 mm
Stripping length	7 mm
Tightening torque	0.22 Nm ... 0.25 Nm

Specifications for ferrules without insulating collar

recommended crimping tool	1212034 CRIMPFOX 6
---------------------------	--------------------

Specifications for ferrules with insulating collar

recommended crimping tool	1212034 CRIMPFOX 6
---------------------------	--------------------

Material specifications

Material data - contact

Note	WEEE/RoHS-compliant, free of whiskers according to IEC 60068-2-82/JEDEC JESD 201
Contact material	Cu alloy
Surface characteristics	hot-dip tin-plated
Metal surface terminal point (top layer)	Tin (4 - 8 µm Sn)
Metal surface contact area (top layer)	Tin (4 - 8 µm Sn)

Material data - housing

Color (Housing)	green (6021)
Insulating material	PA
Insulating material group	I
CTI according to IEC 60112	600
Flammability rating according to UL 94	V0
Glow wire flammability index GWFI according to EN 60695-2-12	850
Glow wire ignition temperature GWIT according to EN 60695-2-13	775
Temperature for the ball pressure test according to EN 60695-10-2	125 °C

Dimensions

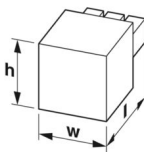
Dimensional drawing	
Pitch	3.81 mm

MC 1,5/ 6-ST-3,81 - PCB connector



1803617

<https://www.phoenixcontact.com/us/products/1803617>

Width [w]	23.65 mm
Height [h]	11.1 mm
Length [l]	16.1 mm

Mounting

Drive form screw head	Slotted (L)
Drive form screw head	Slotted (L)

Mechanical tests

Test for conductor damage and slackening

Specification	IEC 60999-1:1999-11
Result	Test passed

Pull-out test

Specification	IEC 60999-1:1999-11
Conductor cross section/conductor type/tractive force setpoint/actual value	0.14 mm ² / solid / > 7 N
	0.14 mm ² / flexible / > 7 N
	1.5 mm ² / solid / > 40 N
	1.5 mm ² / flexible / > 40 N

Insertion and withdrawal forces

Result	Test passed
No. of cycles	25
Insertion strength per pos. approx.	6 N
Withdraw strength per pos. approx.	4 N

Torque test

Specification	IEC 60999-1:1999-11
---------------	---------------------

Resistance of inscriptions

Specification	IEC 60068-2-70:1995-12
Result	Test passed

Polarization and coding

Specification	IEC 60512-13-5:2006-02
Result	Test passed

Visual inspection

Specification	IEC 60512-1-1:2002-02
Result	Test passed

Dimension check

Specification	IEC 60512-1-2:2002-02
Result	Test passed

Environmental and real-life conditions

Vibration test

MC 1,5/ 6-ST-3,81 - PCB connector



1803617

<https://www.phoenixcontact.com/us/products/1803617>

Specification	IEC 60068-2-6:2007-12
Frequency	10 - 150 - 10 Hz
Sweep speed	1 octave/min
Amplitude	0.35 mm (10 Hz ... 60.1 Hz)
Sweep speed	5g (60.1 Hz ... 150 Hz)
Test duration per axis	2.5 h

Durability test

Specification	IEC 60512-9-1:2010-03
Impulse withstand voltage at sea level	2.95 kV
Contact resistance R ₁	1.3 mΩ
Contact resistance R ₂	1.5 mΩ
Insertion/withdrawal cycles	25
Insulation resistance, neighboring positions	> 5 MΩ

Climatic test

Specification	ISO 6988:1985-02
Corrosive stress	0.2 dm ³ SO ₂ on 300 dm ³ /40 °C/1 cycle
Thermal stress	100 °C/168 h
Power-frequency withstand voltage	1.39 kV

Ambient conditions

Ambient temperature (operation)	-40 °C ... 100 °C (dependent on the derating curve)
Ambient temperature (storage/transport)	-40 °C ... 70 °C
Relative humidity (storage/transport)	30 % ... 70 %
Ambient temperature (assembly)	-5 °C ... 100 °C

Electrical tests

Thermal test | Test group C

Specification	IEC 60512-5-1:2002-02
Tested number of positions	20

Insulation resistance

Specification	IEC 60512-3-1:2002-02
Insulation resistance, neighboring positions	> 5 MΩ

Air clearances and creepage distances |

Specification	IEC 60664-1:2007-04
Insulating material group	I
Comparative tracking index (IEC 60112)	CTI 600
Rated insulation voltage (III/3)	160 V
Rated surge voltage (III/3)	2.5 kV
minimum clearance value - non-homogenous field (III/3)	1.5 mm
minimum creepage distance (III/3)	2 mm
Note on connection cross section	With connected conductor 1.5 mm ² (solid).
Rated insulation voltage (III/2)	160 V

MC 1,5/ 6-ST-3,81 - PCB connector



1803617

<https://www.phoenixcontact.com/us/products/1803617>

Rated surge voltage (III/2)	2.5 kV
minimum clearance value - non-homogenous field (III/2)	1.5 mm
minimum creepage distance (III/2)	1.5 mm
Rated insulation voltage (II/2)	320 V
Rated surge voltage (II/2)	2.5 kV
minimum clearance value - non-homogenous field (II/2)	1.5 mm
minimum creepage distance (II/2)	1.6 mm

Packaging specifications

Type of packaging	packed in cardboard
-------------------	---------------------

Drawings

Diagram

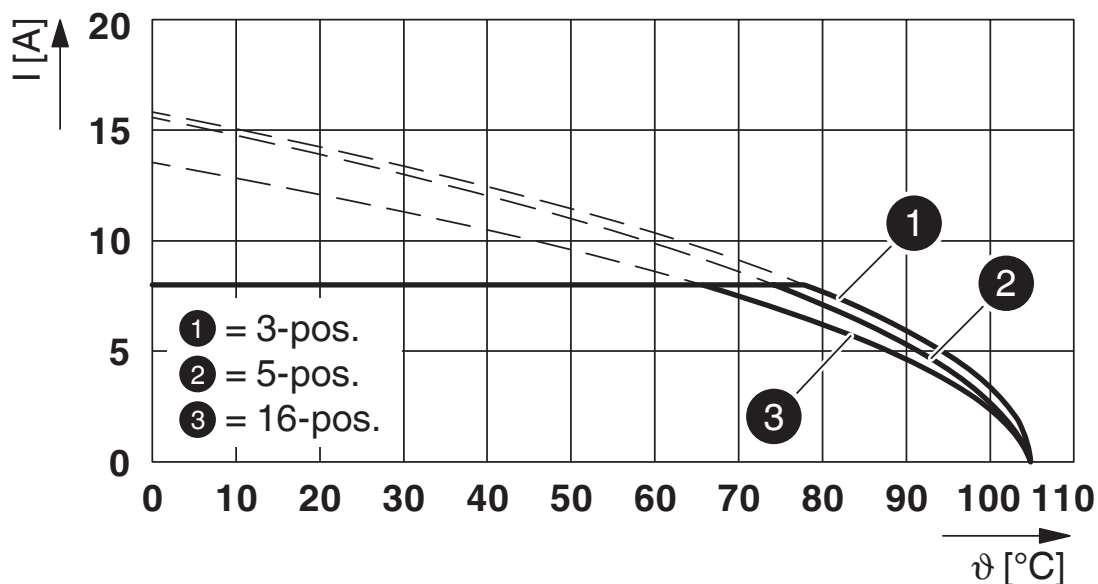

Type: MC 1,5/...-ST-3,81 with MCVK 1,5/...-G-3,81

Diagram

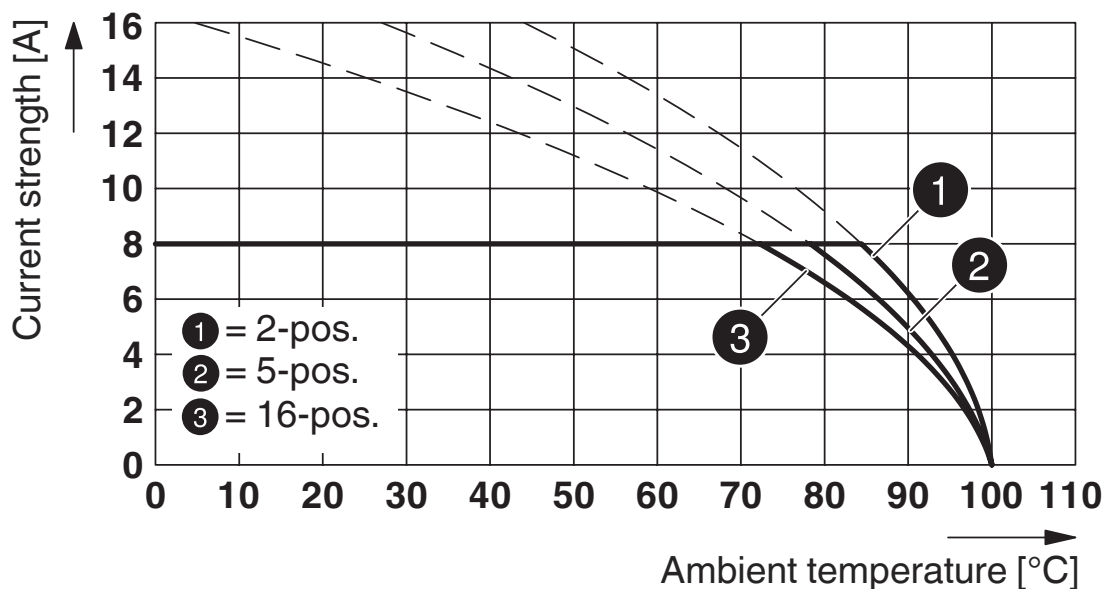

Type: MC 1,5/...-ST-3,81 with IMC 1,5/...-ST-3,81

MC 1,5/ 6-ST-3,81 - PCB connector



1803617

<https://www.phoenixcontact.com/us/products/1803617>

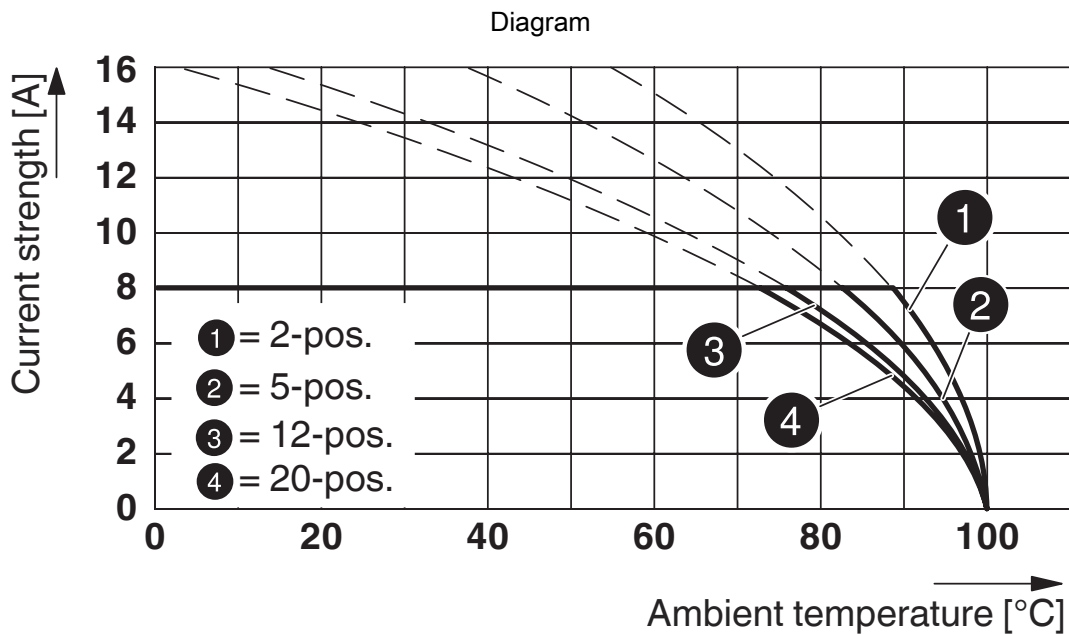

Type: MC 1,5/...-ST-3,81 with MCV 1,5/...-G-3,81

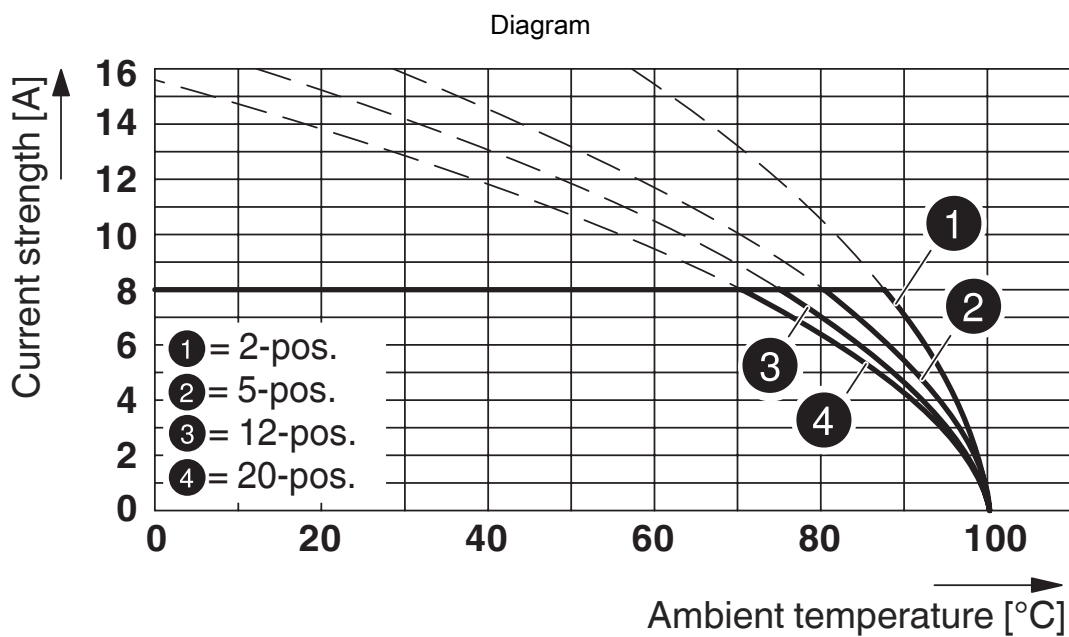

Type: MC 1,5/...-ST-3,81 with MC 1,5/...-G-3,81

MC 1,5/ 6-ST-3,81 - PCB connector



1803617

<https://www.phoenixcontact.com/us/products/1803617>

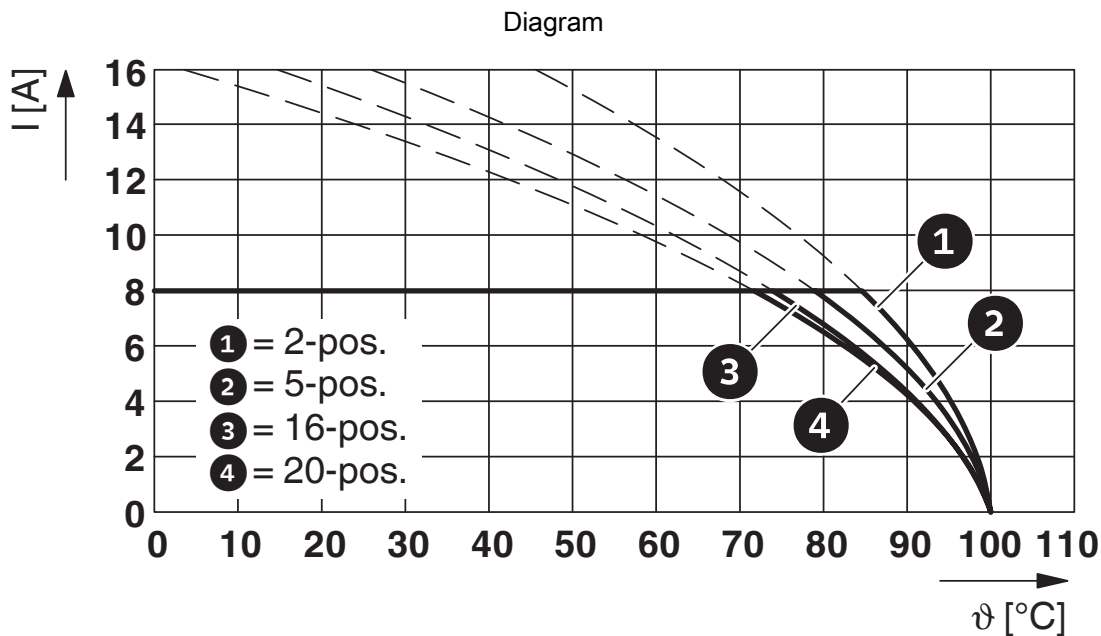

Type: MC 1,5/...-ST-3,81 with MC 1,5/...-G-3,81 P...THR

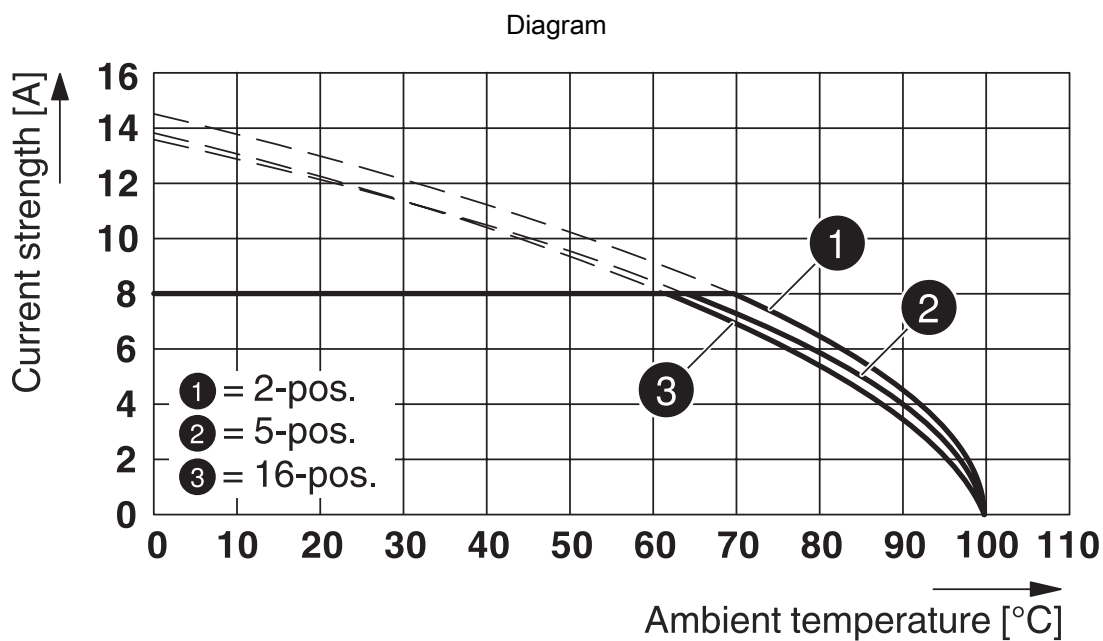

Type: MC 1,5/...-ST-3,81 with MCVU 1,5/...-GFD-3,81

MC 1,5/ 6-ST-3,81 - PCB connector

1803617

<https://www.phoenixcontact.com/us/products/1803617>

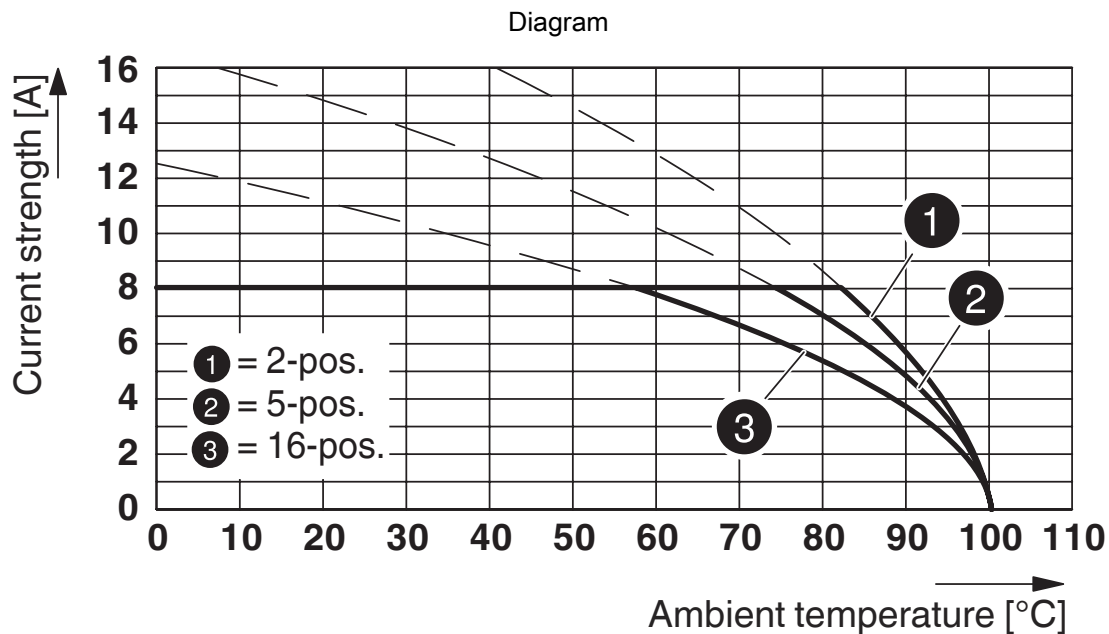

Type: MC 1,5/...-ST-3,81 with MCD 1,5/...-G1-3,81

Dimensional drawing

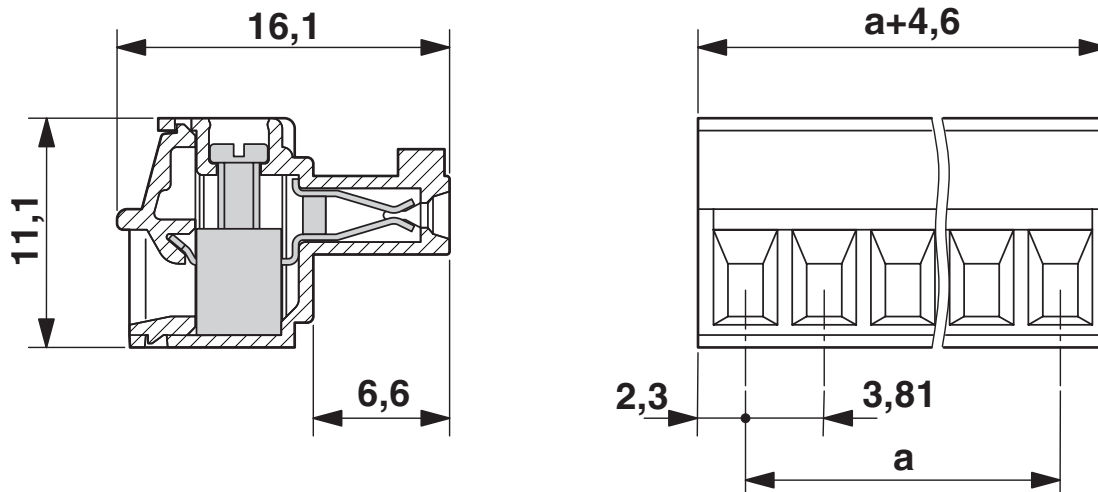

MC 1,5/ 6-ST-3,81 - PCB connector



1803617

<https://www.phoenixcontact.com/us/products/1803617>

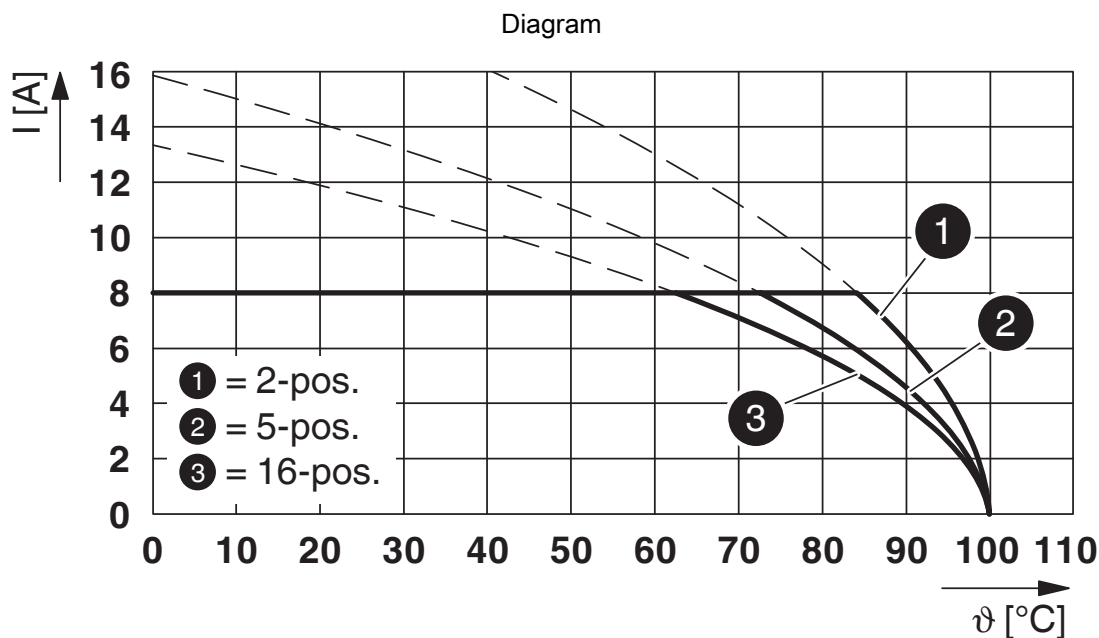

Type: MC 1,5/...-ST-3,81 with MCD 1,5/...-G-3,81

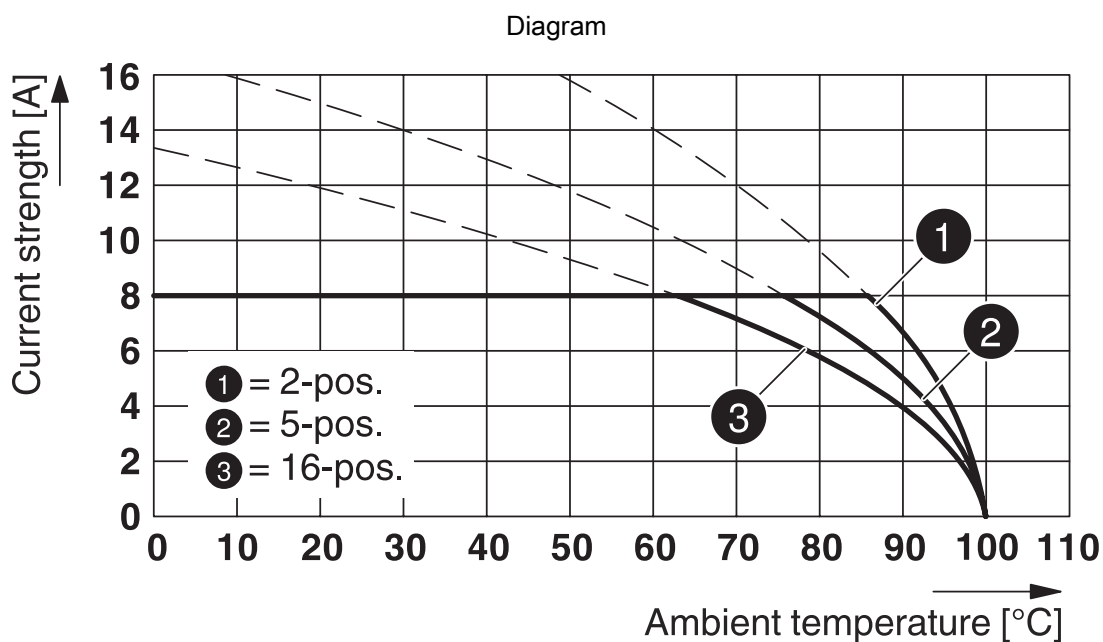

Type: MC 1,5/...-ST-3,81 with MCDV 1,5/...-G1-3,81

MC 1,5/ 6-ST-3,81 - PCB connector



1803617

<https://www.phoenixcontact.com/us/products/1803617>

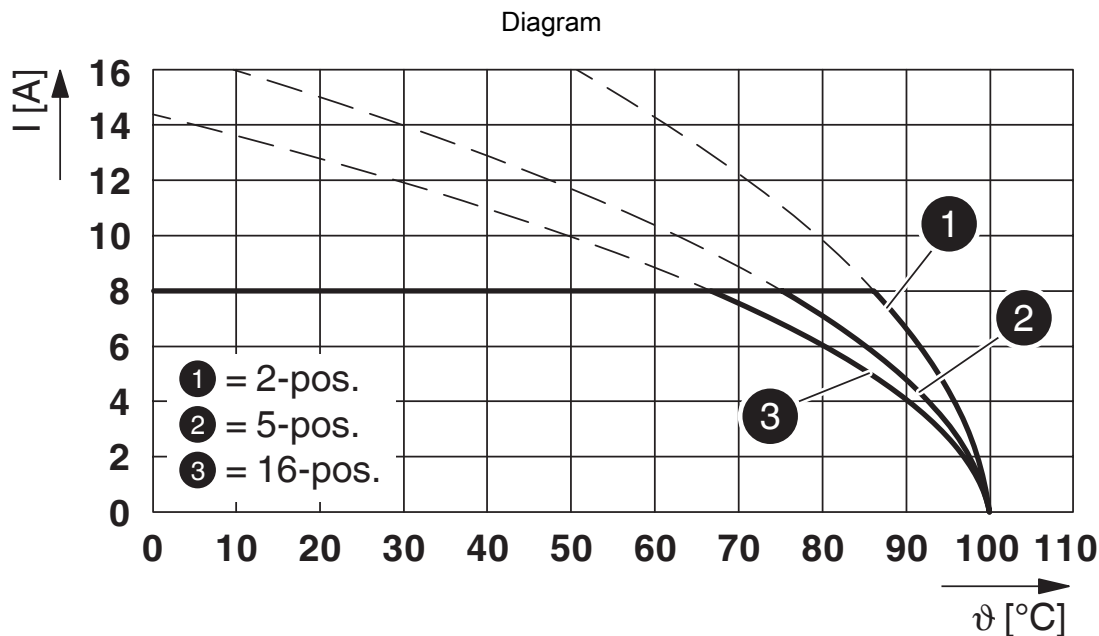

Type: MC 1,5/...-ST-3,81 with MCDV 1,5/...-G-3,81

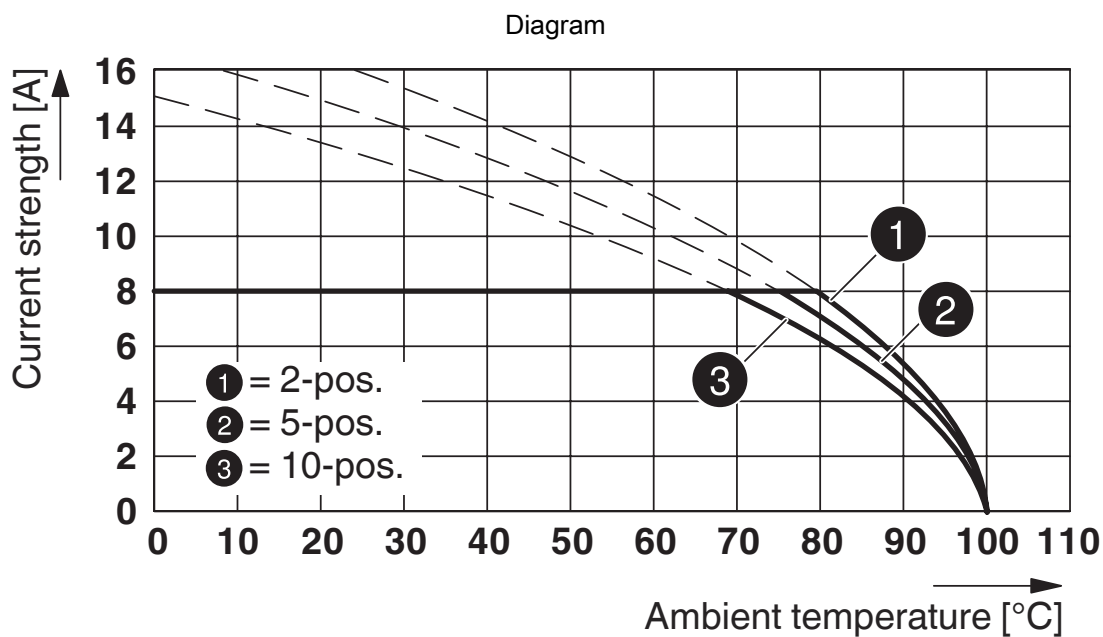

Type: MC 1,5/...-ST-3,81 with MCO 1,5/...-GR-3,81

MC 1,5/ 6-ST-3,81 - PCB connector



1803617

<https://www.phoenixcontact.com/us/products/1803617>

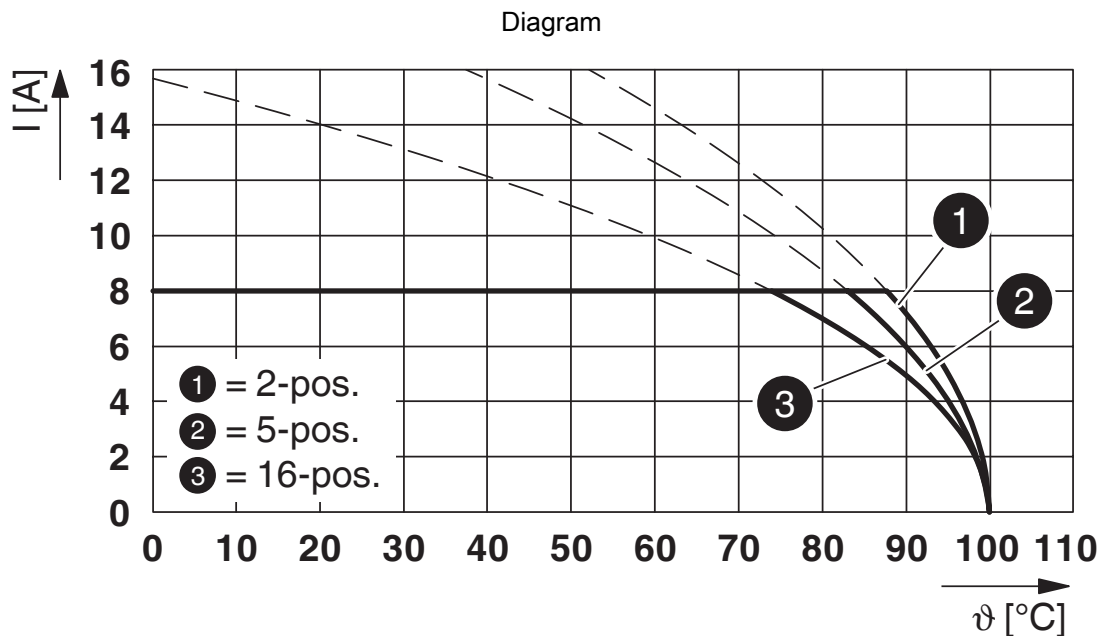

Type: MC 1,5/...-ST-3,81 with SMC 1,5/...-G-3,81

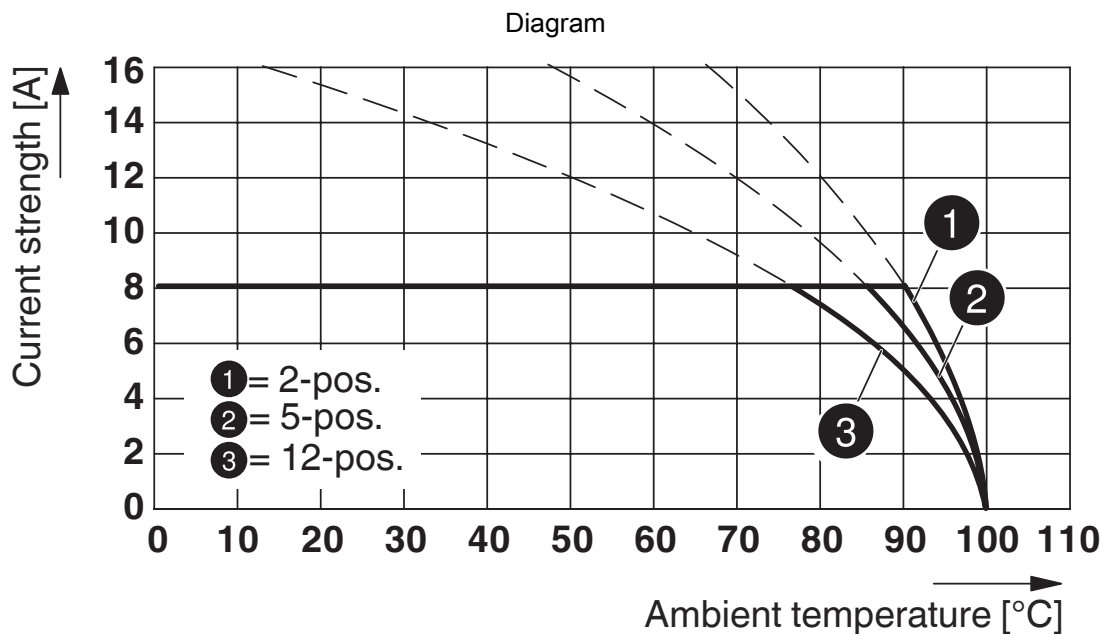

Type: MC 1,5/...-ST-3,81 with MCV 1,5/...-G-3,81 P26 THR

MC 1,5/ 6-ST-3,81 - PCB connector





1803617

<https://www.phoenixcontact.com/us/products/1803617>

Approvals

To download certificates, visit the product detail page: <https://www.phoenixcontact.com/us/products/1803617>

 CSA Approval ID: 13631				
	Nominal voltage U_N	Nominal current I_N	Cross section AWG	Cross section mm^2
Use group B				
	300 V	8 A	28 - 16	-
Use group D				
	300 V	8 A	28 - 16	-

 cULus Recognized Approval ID: E60425-20110128				
	Nominal voltage U_N	Nominal current I_N	Cross section AWG	Cross section mm^2
Use group B				
	300 V	8 A	30 - 14	-
Use group D				
	300 V	8 A	30 - 14	-

 VDE Zeichengenehmigung Approval ID: 40011723				
	Nominal voltage U_N	Nominal current I_N	Cross section AWG	Cross section mm^2
	160 V	8 A	-	0.2 - 1.5

MC 1,5/ 6-ST-3,81 - PCB connector



1803617

<https://www.phoenixcontact.com/us/products/1803617>

Classifications

ECLASS

ECLASS-11.0	27460202
ECLASS-12.0	27460202
ECLASS-13.0	27460202

ETIM

ETIM 9.0	EC002638
----------	----------

UNSPSC

UNSPSC 21.0	39121400
-------------	----------

MC 1,5/ 6-ST-3,81 - PCB connector



1803617

<https://www.phoenixcontact.com/us/products/1803617>

Environmental product compliance

EU RoHS

Fulfills EU RoHS substance requirements	Yes, No exemptions
---	--------------------

China RoHS

Environment friendly use period (EFUP)	EFUP-E
	No hazardous substances above the limits

EU REACH SVHC

REACH candidate substance (CAS No.)	No substance above 0.1 wt%
-------------------------------------	----------------------------

MC 1,5/ 6-ST-3,81 - PCB connector

1803617

<https://www.phoenixcontact.com/us/products/1803617>



Accessories

SK 3,81/2,8:FORTL.ZAHLEN - Marker card

0804109

<https://www.phoenixcontact.com/us/products/0804109>

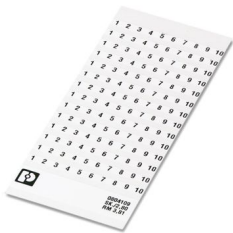

Marker card, Sheet, white, labeled, horizontal: consecutive numbers 1 ... 10, 11 .. 20, etc. up to 91 ... (99)100, mounting type: adhesive, for terminal block width: 3.81 mm, lettering field size: 3.81 x 2.8 mm, Number of individual labels: 14

SZS 0,4X2,5 VDE - Screwdriver

1205037

<https://www.phoenixcontact.com/us/products/1205037>



Screwdriver, slot-headed, VDE insulated, size: 0.4 x 2.5 x 80 mm, 2-component grip, with non-slip grip

MC 1,5/ 6-ST-3,81 - PCB connector

1803617

<https://www.phoenixcontact.com/us/products/1803617>



KGG-MC 1,5/ 6 - Cable housing

1834385

<https://www.phoenixcontact.com/us/products/1834385>



Cable housing, Cable housing, color: green, product range: KGG-MC 1,5, width: 14.5 mm

EBPL 2-3,81 - Insertion bridge

1733495

<https://www.phoenixcontact.com/us/products/1733495>



Insertion bridge for plugs featuring a screw connection with a 3.81 mm pitch

MC 1,5/ 6-ST-3,81 - PCB connector

1803617

<https://www.phoenixcontact.com/us/products/1803617>



EBPL 3-3,81 - Insertion bridge

1733505

<https://www.phoenixcontact.com/us/products/1733505>

Insertion bridge for plugs featuring a screw connection with a 3.81 mm pitch



EBPL 4-3,81 - Insertion bridge

1733518

<https://www.phoenixcontact.com/us/products/1733518>

Insertion bridge for plugs featuring a screw connection with a 3.81 mm pitch



MC 1,5/ 6-ST-3,81 - PCB connector



1803617

<https://www.phoenixcontact.com/us/products/1803617>

MCV 1,5/ 6-G-3,81 P14 THR - PCB header

1707049

<https://www.phoenixcontact.com/us/products/1707049>

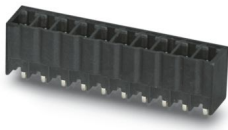

PCB headers, nominal cross section: 1.5 mm², color: black, nominal current: 8 A, rated voltage (III/2): 160 V, contact surface: Tin, contact connection type: Pin, number of potentials: 6, number of rows: 1, number of positions: 6, number of connections: 6, product range: MCV 1,5/..-G-THR, pitch: 3.81 mm, mounting: THR soldering, pin layout: Linear pinning, solder pin [P]: 1.4 mm, number of solder pins per potential: 1, plug-in system: COMBICON MC 1,5, Pin connector pattern alignment: Standard, locking: without, mounting: without, type of packaging: packed in cardboard, For user information and design recommendations for through-hole reflow technology, go to: Downloads

MCV 1,5/ 6-G-3,81 P26 THR - PCB header

1707463

<https://www.phoenixcontact.com/us/products/1707463>

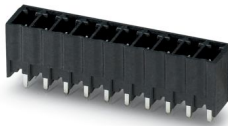

PCB headers, nominal cross section: 1.5 mm², color: black, nominal current: 8 A, rated voltage (III/2): 160 V, contact surface: Tin, contact connection type: Pin, number of potentials: 6, number of rows: 1, number of positions: 6, number of connections: 6, product range: MCV 1,5/..-G-THR, pitch: 3.81 mm, mounting: THR soldering, pin layout: Linear pinning, solder pin [P]: 2.6 mm, number of solder pins per potential: 1, plug-in system: COMBICON MC 1,5, Pin connector pattern alignment: Standard, locking: without, mounting: without, type of packaging: packed in cardboard, For user information and design recommendations for through-hole reflow technology, go to: Downloads

MC 1,5/ 6-ST-3,81 - PCB connector

1803617

<https://www.phoenixcontact.com/us/products/1803617>



MCO 1,5/ 6-GL-3,81 - PCB header

1861769

<https://www.phoenixcontact.com/us/products/1861769>



PCB headers, nominal cross section: 1.5 mm², color: green, nominal current: 8 A, rated voltage (III/2): 160 V, contact surface: Tin, contact connection type: Pin, number of potentials: 6, number of rows: 1, number of positions: 6, number of connections: 6, product range: MCO 1,5/...-GL, pitch: 3.81 mm, mounting: Wave soldering, pin layout: Linear pinning, solder pin [P]: 3 mm, number of solder pins per potential: 1, plug-in system: COMBICON MC 1,5, locking: without, mounting: without, type of packaging: packed in cardboard

Phoenix Contact 2024 © - all rights reserved

<https://www.phoenixcontact.com>

Phoenix Contact USA
586 Fulling Mill Road
Middletown, PA 17057, United States
(+717) 944-1300
info@phoenixcon.com