

MVSTBR 2,5/ 4-ST - PCB connector



1792032

<https://www.phoenixcontact.com/us/products/1792032>

Please be informed that the data shown in this PDF document is generated from our online catalog. Please find the complete data in the user documentation. Our general terms of use for downloads are valid.



PCB connector, nominal cross section: 2.5 mm², color: green, nominal current: 12 A, rated voltage (III/2): 320 V, contact surface: Tin, contact connection type: Socket, number of potentials: 4, number of rows: 1, number of positions: 4, number of connections: 4, product range: MVSTBR 2,5/...-ST, pitch: 5 mm, connection method: Screw connection with tension sleeve, screw head form: L Slotted, conductor/PCB connection direction: 90 °, locking clip: - Locking clip, plug-in system: COMBICON MSTB 2,5, locking: without, mounting: without, type of packaging: packed in cardboard

Your advantages

- Well-known connection principle allows worldwide use
- Low temperature rise, thanks to maximum contact force
- Allows connection of two conductors

Commercial data

Item number	1792032
Packing unit	100 pc
Minimum order quantity	100 pc
Sales key	AA03
Product key	AACAJC
Catalog page	Page 266 (C-1-2013)
GTIN	4017918044510
Weight per piece (including packing)	8.511 g
Weight per piece (excluding packing)	8.44 g
Customs tariff number	85366990
Country of origin	DE

MVSTBR 2,5/ 4-ST - PCB connector



1792032

<https://www.phoenixcontact.com/us/products/1792032>

Technical data

Product properties

Product type	PCB connector
Product family	MVSTBR 2,5/..-ST
Product line	COMBICON Connectors M
Type	Standard
Number of positions	4
Pitch	5 mm
Number of connections	4
Number of rows	1
Number of potentials	4
Mounting flange	without

Electrical properties

Nominal current I_N	12 A
Nominal voltage U_N	320 V
Degree of pollution	3
Contact resistance	2.5 m Ω
Rated voltage (III/3)	250 V
Rated surge voltage (III/3)	4 kV
Rated voltage (III/2)	320 V
Rated surge voltage (III/2)	4 kV
Rated voltage (II/2)	630 V
Rated surge voltage (II/2)	4 kV

Connection data

Connection technology

Connector system	COMBICON MSTB 2,5
Nominal cross section	2.5 mm ²
Contact connection type	Socket

Interlock

Locking type	without
Mounting flange	without

Conductor connection

Connection method	Screw connection with tension sleeve
Conductor/PCB connection direction	90 °
Conductor cross section rigid	0.2 mm ² ... 2.5 mm ²
Conductor cross section flexible	0.2 mm ² ... 2.5 mm ²
Conductor cross section AWG	24 ... 12
Conductor cross section flexible, with ferrule without plastic sleeve	0.25 mm ² ... 2.5 mm ²

MVSTBR 2,5/ 4-ST - PCB connector

1792032

<https://www.phoenixcontact.com/us/products/1792032>

Conductor cross section, flexible, with ferrule, with plastic sleeve	0.25 mm ² ... 2.5 mm ²
2 conductors with same cross section, solid	0.2 mm ² ... 1 mm ²
2 conductors with same cross section, flexible	0.2 mm ² ... 1.5 mm ²
2 conductors with same cross section, flexible, with ferrule without plastic sleeve	0.25 mm ² ... 1 mm ²
2 conductors with the same cross section, flexible, with TWIN ferrule with plastic sleeve	0.5 mm ² ... 1.5 mm ²
Cylindrical gauge a x b / diameter	2.8 mm x 2.0 mm / 2.4 mm
Stripping length	7 mm
Tightening torque	0.5 Nm ... 0.6 Nm

Specifications for ferrules without insulating collar

recommended crimping tool	1212034 CRIMPFOX 6
---------------------------	--------------------

Specifications for ferrules with insulating collar

recommended crimping tool	1212034 CRIMPFOX 6
---------------------------	--------------------

Material specifications

Material data - contact

Note	WEEE/RoHS-compliant, free of whiskers according to IEC 60068-2-82/JEDEC JESD 201
Contact material	Cu alloy
Surface characteristics	hot-dip tin-plated
Metal surface terminal point (top layer)	Tin (4 - 8 µm Sn)
Metal surface contact area (top layer)	Tin (4 - 8 µm Sn)

Material data - housing

Color (Housing)	green (6021)
Insulating material	PA
Insulating material group	I
CTI according to IEC 60112	600
Flammability rating according to UL 94	V0
Glow wire flammability index GWFI according to EN 60695-2-12	850
Glow wire ignition temperature GWIT according to EN 60695-2-13	775
Temperature for the ball pressure test according to EN 60695-10-2	125 °C

Dimensions

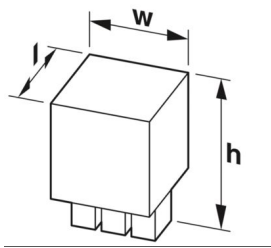
Dimensional drawing	
---------------------	--

MVSTBR 2,5/ 4-ST - PCB connector



1792032

<https://www.phoenixcontact.com/us/products/1792032>

Pitch	5 mm
Width [w]	20 mm
Height [h]	26 mm
Length [l]	12.5 mm

Mounting

Drive form screw head	Slotted (L)
Drive form screw head	Slotted (L)

Notes

Notes on operation	In accordance with IEC 61984, COMBICON connectors have no switching power (COC). During designated use, they must not be plugged in or disconnected when carrying voltage or under load.
--------------------	--

Mechanical tests

Test for conductor damage and slackening

Specification	IEC 60999-1:1999-11
Result	Test passed

Pull-out test

Specification	IEC 60999-1:1999-11
Conductor cross section/conductor type/tractive force setpoint/actual value	0.2 mm ² / solid / > 10 N
	0.2 mm ² / flexible / > 10 N
	2.5 mm ² / solid / > 50 N
	2.5 mm ² / flexible / > 50 N

Insertion and withdrawal forces

Result	Test passed
No. of cycles	25
Insertion strength per pos. approx.	8 N
Withdraw strength per pos. approx.	6 N

Torque test

Specification	IEC 60999-1:1999-11
---------------	---------------------

Resistance of inscriptions

Specification	IEC 60068-2-70:1995-12
Result	Test passed

Polarization and coding

Specification	IEC 60512-13-5:2006-02
Result	Test passed

Visual inspection

Specification	IEC 60512-1-1:2002-02
Result	Test passed

Dimension check

MVSTBR 2,5/ 4-ST - PCB connector



1792032

<https://www.phoenixcontact.com/us/products/1792032>

Specification	IEC 60512-1-2:2002-02
Result	Test passed

Environmental and real-life conditions

Vibration test

Specification	IEC 60068-2-6:2007-12
Frequency	10 - 150 - 10 Hz
Sweep speed	1 octave/min
Amplitude	0.35 mm (10 Hz ... 60.1 Hz)
Sweep speed	5g (60.1 Hz ... 150 Hz)
Test duration per axis	2.5 h

Durability test

Specification	IEC 60512-9-1:2010-03
Impulse withstand voltage at sea level	4.8 kV
Contact resistance R ₁	2.5 mΩ
Contact resistance R ₂	2.5 mΩ
Insertion/withdrawal cycles	25
Insulation resistance, neighboring positions	> 5 MΩ

Climatic test

Specification	ISO 6988:1985-02
Corrosive stress	0.2 dm ³ SO ₂ on 300 dm ³ /40 °C/1 cycle
Thermal stress	100 °C/168 h
Power-frequency withstand voltage	2.21 kV

Ambient conditions

Ambient temperature (operation)	-40 °C ... 100 °C (dependent on the derating curve)
Ambient temperature (storage/transport)	-40 °C ... 70 °C
Relative humidity (storage/transport)	30 % ... 70 %
Ambient temperature (assembly)	-5 °C ... 100 °C

Electrical tests

Thermal test | Test group C

Specification	IEC 60512-5-1:2002-02
Tested number of positions	24

Insulation resistance

Specification	IEC 60512-3-1:2002-02
Insulation resistance, neighboring positions	> 5 MΩ

Air clearances and creepage distances |

Specification	IEC 60664-1:2007-04
Insulating material group	I
Comparative tracking index (IEC 60112)	CTI 600

MVSTBR 2,5/ 4-ST - PCB connector



1792032

<https://www.phoenixcontact.com/us/products/1792032>

Rated insulation voltage (III/3)	250 V
Rated surge voltage (III/3)	4 kV
minimum clearance value - non-homogenous field (III/3)	3 mm
minimum creepage distance (III/3)	3.2 mm
Rated insulation voltage (III/2)	320 V
Rated surge voltage (III/2)	4 kV
minimum clearance value - non-homogenous field (III/2)	3 mm
minimum creepage distance (III/2)	3 mm
Rated insulation voltage (II/2)	630 V
Rated surge voltage (II/2)	4 kV
minimum clearance value - non-homogenous field (II/2)	3 mm
minimum creepage distance (II/2)	3.2 mm

Packaging specifications

Type of packaging	packed in cardboard
-------------------	---------------------

1792032

<https://www.phoenixcontact.com/us/products/1792032>

Drawings

Diagram

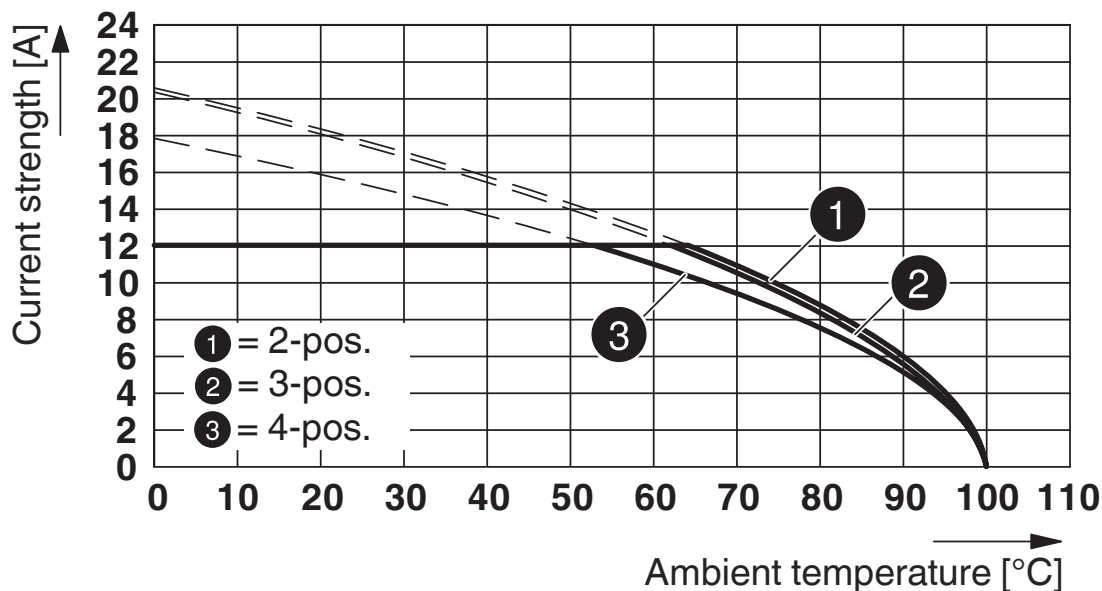

Type: MVSTB(RW) 2,5/...-ST with MSTBO 2,5/...-G1L

Diagram

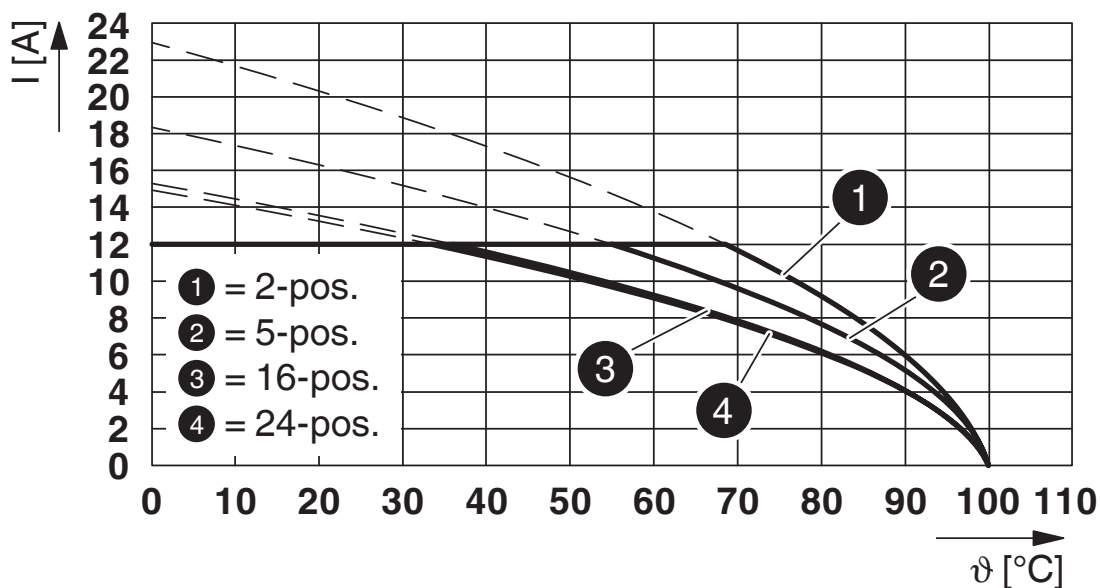

Type: MVSTBR 2,5/...-ST with MSTBA 2,5/...-G

MVSTBR 2,5/ 4-ST - PCB connector



1792032

<https://www.phoenixcontact.com/us/products/1792032>

Diagram

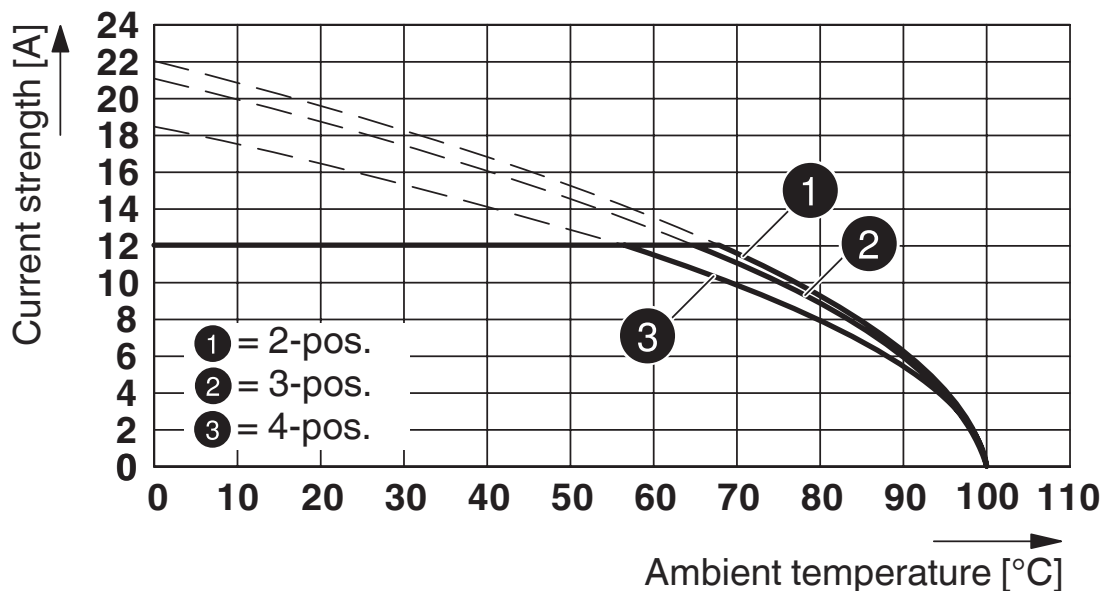

Type: MVSTB(RW) 2,5/...-ST with MSTBO 2,5/...-G1R

Diagram

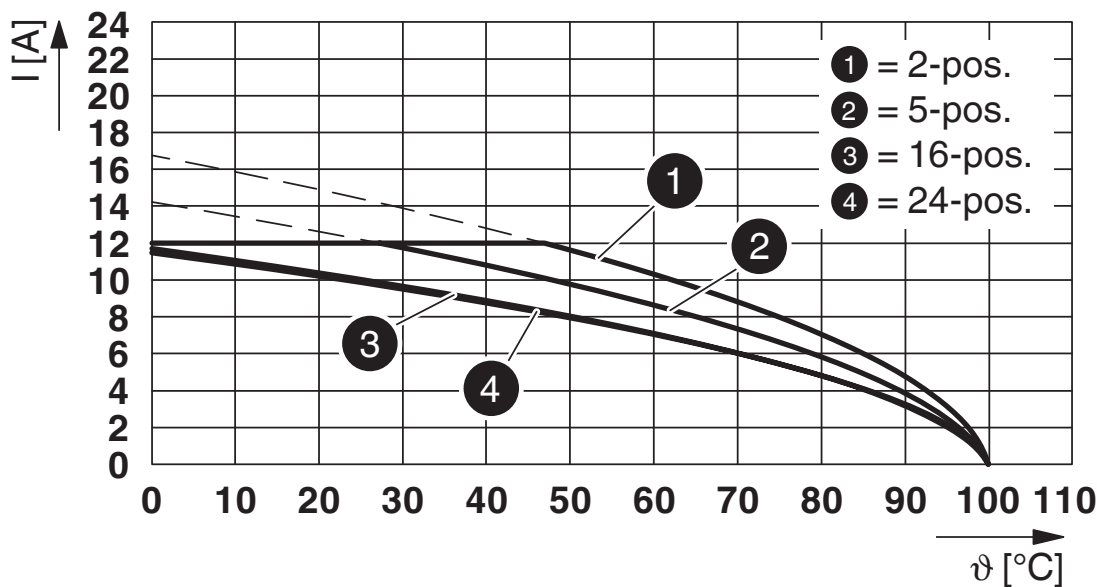

Type: MVSTBR 2,5/...-ST with MSTBVA 2,5/...-G

1792032

<https://www.phoenixcontact.com/us/products/1792032>

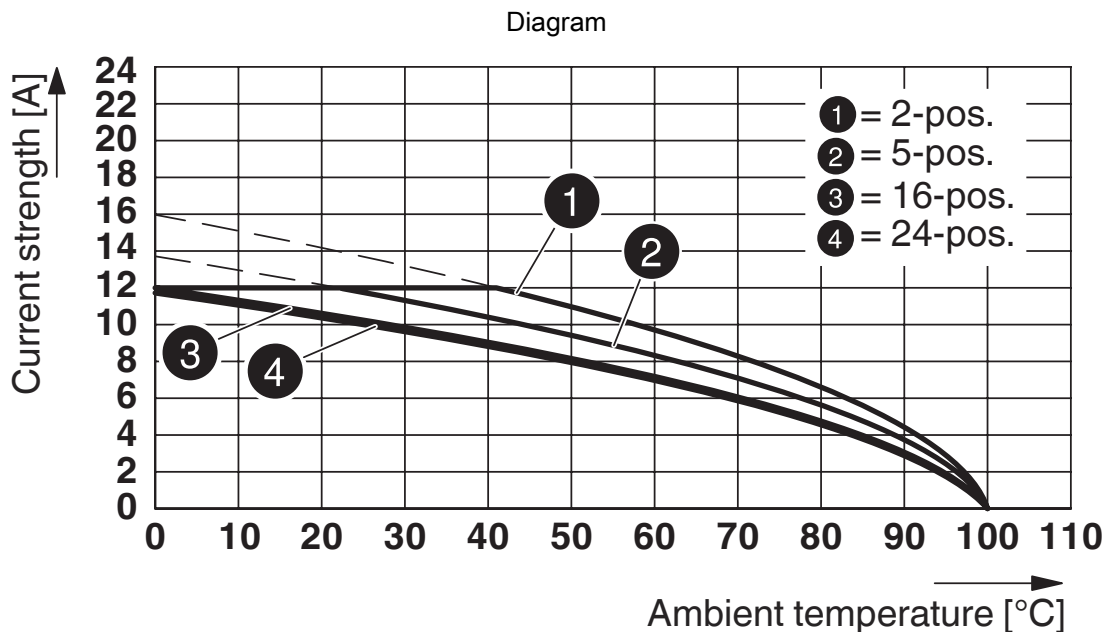

Type: MVSTB(R/W) 2,5/...-ST with MSTBV 2,5 2,5/...-G

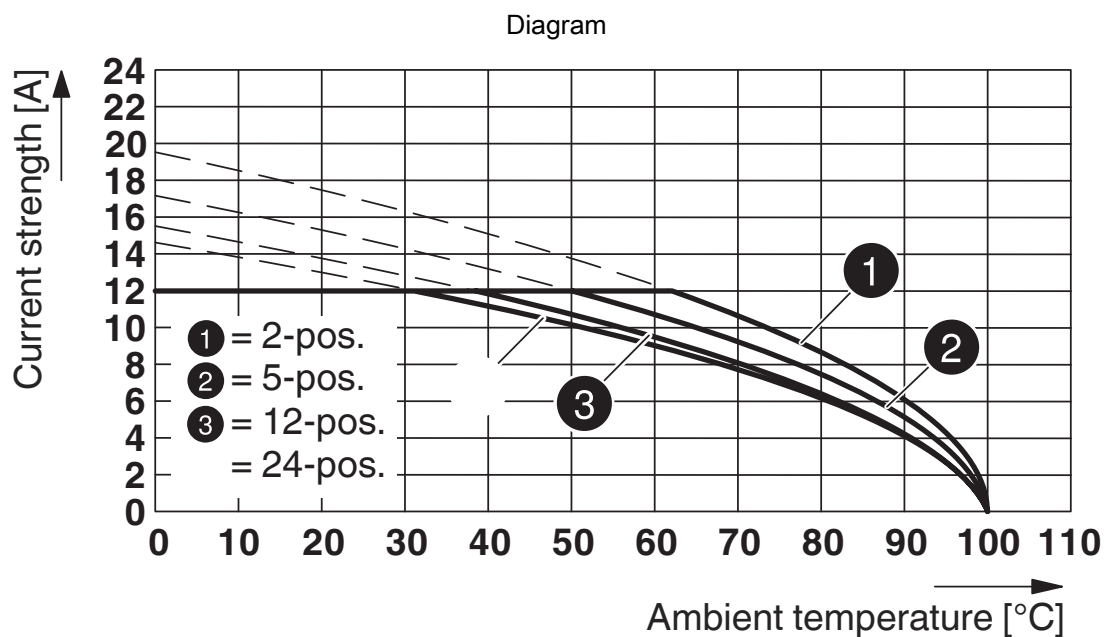

Type: MVSTB(R/W) 2,5/...-ST with MSTB 2,5/...-G

1792032

<https://www.phoenixcontact.com/us/products/1792032>

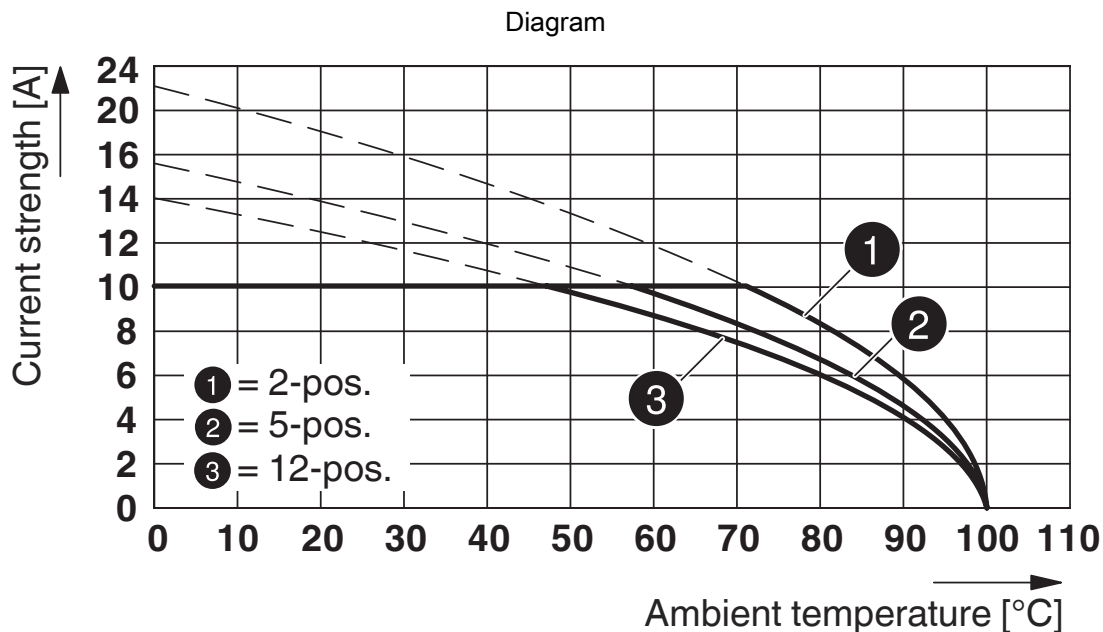

Type: MVSTB(R/W) 2,5/...-ST with MDSTB 2,5/...-G

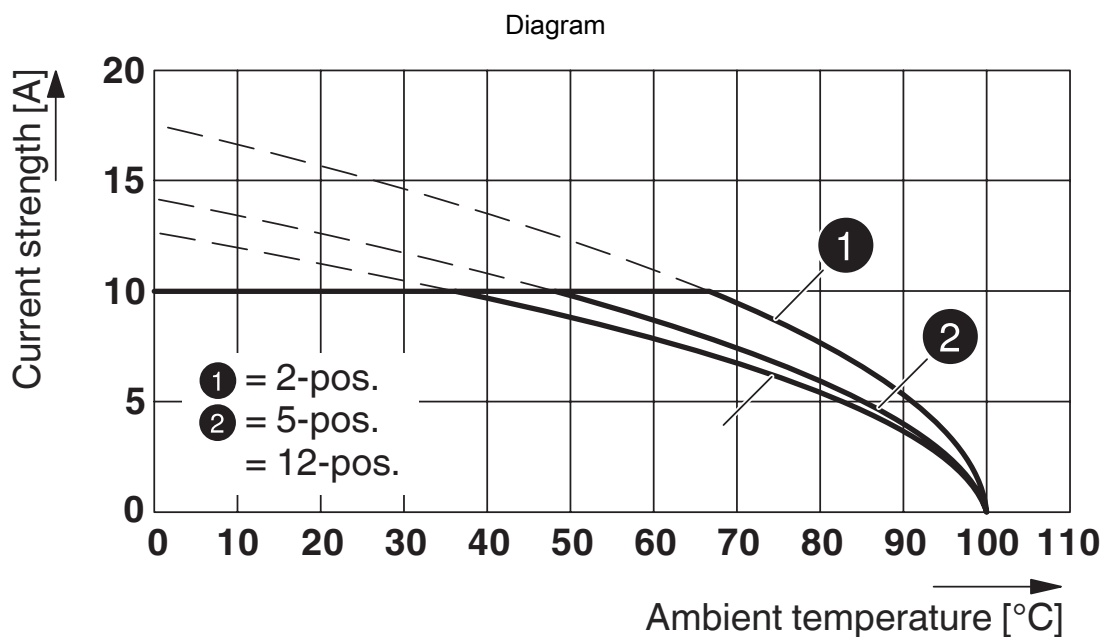

Type: MVSTB(R/W) 2,5/...-ST with MDSTBW 2,5/...-G

Diagram

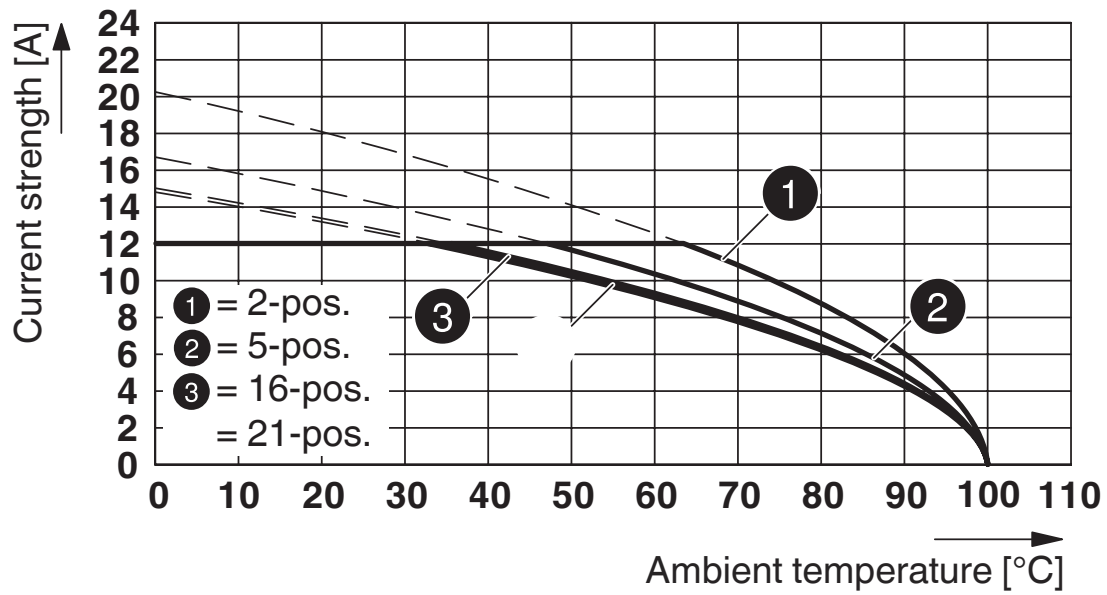

Type: MVSTB(R/W) 2,5/...-ST with MSTBW 2,5/...-G

MVSTBR 2,5/ 4-ST - PCB connector





1792032

<https://www.phoenixcontact.com/us/products/1792032>

Approvals

To download certificates, visit the product detail page: <https://www.phoenixcontact.com/us/products/1792032>

 CSA Approval ID: 13631				
	Nominal voltage U_N	Nominal current I_N	Cross section AWG	Cross section mm^2
Use group B	300 V	10 A	28 - 12	-
Use group D	300 V	10 A	28 - 12	-

 cULus Recognized Approval ID: E60425-19931011				
	Nominal voltage U_N	Nominal current I_N	Cross section AWG	Cross section mm^2
Use group B	300 V	15 A	30 - 12	-
Use group D	300 V	10 A	30 - 12	-

 VDE Zeichengenehmigung Approval ID: 40004701				
	Nominal voltage U_N	Nominal current I_N	Cross section AWG	Cross section mm^2
	250 V	12 A	-	0.2 - 2.5

MVSTBR 2,5/ 4-ST - PCB connector



1792032

<https://www.phoenixcontact.com/us/products/1792032>

Classifications

ECLASS

ECLASS-11.0	27460202
ECLASS-12.0	27460202
ECLASS-13.0	27460202

ETIM

ETIM 9.0	EC002638
----------	----------

UNSPSC

UNSPSC 21.0	39121400
-------------	----------

MVSTBR 2,5/ 4-ST - PCB connector



1792032

<https://www.phoenixcontact.com/us/products/1792032>

Environmental product compliance

EU RoHS

Fulfills EU RoHS substance requirements	Yes, No exemptions
---	--------------------

China RoHS

Environment friendly use period (EFUP)	EFUP-E
	No hazardous substances above the limits

EU REACH SVHC

REACH candidate substance (CAS No.)	No substance above 0.1 wt%
-------------------------------------	----------------------------

MVSTBR 2,5/ 4-ST - PCB connector



1792032

<https://www.phoenixcontact.com/us/products/1792032>

Accessories

SK 5/3,8:UNBEDRUCKT - Marker card

0805409

<https://www.phoenixcontact.com/us/products/0805409>



Marker card, Sheet, white, unlabeled, can be labeled with: Marker pen: without print, mounting type: adhesive, for terminal block width: 5 mm, lettering field size: 5 x 3.8 mm, Number of individual labels: 120

SZS 0,6X3,5 - Screwdriver

1205053

<https://www.phoenixcontact.com/us/products/1205053>



Actuation tool, for ST terminal blocks, insulated, also suitable for use as a bladed screwdriver, size: 0.6 x 3.5 x 100 mm, 2-component grip, with non-slip grip

MVSTBR 2,5/ 4-ST - PCB connector

1792032

<https://www.phoenixcontact.com/us/products/1792032>

CP-MSTB - Coding profile

1734634

<https://www.phoenixcontact.com/us/products/1734634>

Coding profile, is inserted into the slot on the plug or inverted header, red insulating material



MSTBW 2,5/ 4-G - PCB header

1736098

<https://www.phoenixcontact.com/us/products/1736098>

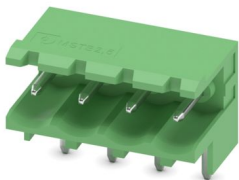

PCB headers, nominal cross section: 2.5 mm², color: green, nominal current: 12 A, rated voltage (III/2): 320 V, contact surface: Tin, contact connection type: Pin, number of potentials: 4, number of rows: 1, number of positions: 4, number of connections: 4, product range: MSTBW 2,5/..-G, pitch: 5 mm, mounting: Wave soldering, pin layout: Linear pinning, solder pin [P]: 3.5 mm, number of solder pins per potential: 1, plug-in system: COMBICON MSTB 2,5, Pin connector pattern alignment: Standard, locking: without, mounting: without, type of packaging: packed in cardboard

MVSTBR 2,5/ 4-ST - PCB connector



1792032

<https://www.phoenixcontact.com/us/products/1792032>

MDSTB 2,5/ 4-G1 - PCB header

1736690

<https://www.phoenixcontact.com/us/products/1736690>

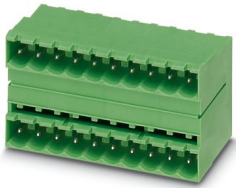

PCB headers, nominal cross section: 2.5 mm², color: green, nominal current: 10 A, rated voltage (III/2): 320 V, contact surface: Tin, contact connection type: Pin, number of potentials: 8, number of rows: 2, number of positions: 4, number of connections: 8, product range: MDSTB 2,5/..-G1, pitch: 5 mm, mounting: Wave soldering, pin layout: Linear pinning, solder pin [P]: 3.3 mm, number of solder pins per potential: 1, plug-in system: COMBICON MSTB 2,5, Pin connector pattern alignment: Standard, locking: without, mounting: without, type of packaging: packed in cardboard, In combination with MVSTB or FKCV plug components, both an MVSTBW (or FKCVW) and an MVSTBR plug (or FKCVR) must be used. Combination with TMSTBP plug components is not possible!

MSTBO 2,5/ 4-G1L THRR44 BK - PCB header

2697194

<https://www.phoenixcontact.com/us/products/2697194>



PCB headers, nominal cross section: 2.5 mm², color: black, nominal current: 16 A, rated voltage (III/2): 320 V, contact surface: Tin, contact connection type: Pin, number of rows: 1, number of positions: 4, product range: MSTBO 2,5/..-G1L-THR, pitch: 5 mm, mounting: THR soldering, pin layout: Linear pinning, solder pin [P]: 2.5 mm, number of solder pins per potential: 1, plug-in system: COMBICON MSTB 2,5, locking: without, type of packaging: 44 mm wide tape, Product with pin output on left side

Phoenix Contact 2024 © - all rights reserved
<https://www.phoenixcontact.com>

Phoenix Contact USA
586 Fulling Mill Road
Middletown, PA 17057, United States
(+717) 944-1300
info@phoenixcon.com