

PC 5/ 4-ST1-7,62 BK - PCB connector



1783665

<https://www.phoenixcontact.com/us/products/1783665>

Please be informed that the data shown in this PDF document is generated from our online catalog. Please find the complete data in the user documentation. Our general terms of use for downloads are valid.

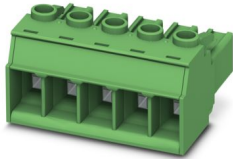

PCB connector, nominal cross section: 6 mm², color: black, nominal current: 41 A, rated voltage (III/2): 1000 V, contact surface: Tin, contact connection type: Socket, number of potentials: 4, number of rows: 1, number of positions: 4, number of connections: 4, product range: PC 5/..-ST1, pitch: 7.62 mm, connection method: Screw connection with tension sleeve, screw head form: H1L Slotted Phillips recess, conductor/PCB connection direction: 0 °, locking clip: - Locking clip, plug-in system: COMBICON PC 5, locking: without, mounting: without, type of packaging: packed in cardboard

Your advantages

- Well-known connection principle allows worldwide use
- Low temperature rise, thanks to maximum contact force
- Allows connection of two conductors
- Integrated double steel spring provides additional safety in the event of temperature and power fluctuations
- 600 V UL approval in the smallest of dimensions

Commercial data

Item number	1783665
Packing unit	50 pc
Minimum order quantity	50 pc
Sales key	AA04
Product key	AADABA
GTIN	4046356556040
Weight per piece (including packing)	18.178 g
Weight per piece (excluding packing)	18.178 g
Customs tariff number	85366990
Country of origin	DE

PC 5/ 4-ST1-7,62 BK - PCB connector



1783665

<https://www.phoenixcontact.com/us/products/1783665>

Technical data

Product properties

Product type	PCB connector
Product family	PC 5/...-ST1
Product line	COMBICON Connectors L
Number of positions	4
Pitch	7.62 mm
Number of connections	4
Number of rows	1
Number of potentials	4
Mounting flange	without

Electrical properties

Nominal current I_N	41 A
Nominal voltage U_N	1000 V
Degree of pollution	3
Contact resistance	0.45 mΩ
Rated voltage (III/3)	1000 V
Rated surge voltage (III/3)	8 kV
Rated voltage (III/2)	1000 V
Rated surge voltage (III/2)	8 kV
Rated voltage (II/2)	1000 V
Rated surge voltage (II/2)	6 kV

Connection data

Connection technology

Type	Standard
Connector system	COMBICON PC 5
Nominal cross section	6 mm ²
Contact connection type	Socket

Interlock

Locking type	without
Mounting flange	without

Conductor connection

Connection method	Screw connection with tension sleeve
Conductor/PCB connection direction	0 °
Conductor cross section rigid	0.2 mm ² ... 10 mm ²
Conductor cross section flexible	0.2 mm ² ... 6 mm ²
Conductor cross section AWG	24 ... 10
Conductor cross section flexible, with ferrule without plastic sleeve	0.25 mm ² ... 6 mm ²

PC 5/ 4-ST1-7,62 BK - PCB connector

1783665

<https://www.phoenixcontact.com/us/products/1783665>

Conductor cross section, flexible, with ferrule, with plastic sleeve	0.25 mm ² ... 4 mm ²
2 conductors with same cross section, solid	0.2 mm ² ... 2.5 mm ²
2 conductors with same cross section, flexible	0.2 mm ² ... 4 mm ²
2 conductors with same cross section, flexible, with ferrule without plastic sleeve	0.25 mm ² ... 1.5 mm ²
2 conductors with the same cross section, flexible, with TWIN ferrule with plastic sleeve	0.25 mm ² ... 2.5 mm ²
Cylindrical gauge a x b / diameter	3.6 mm x 3.1 mm / 3.4 mm
Stripping length	10 mm
Tightening torque	0.5 Nm ... 0.8 Nm ($\leq 4 \text{ mm}^2$ is 0.5 Nm to 0.6 Nm, $> 4 \text{ mm}^2$ is 0.7 Nm to 0.8 Nm)

Material specifications

Material data - contact

Note	WEEE/RoHS-compliant, free of whiskers according to IEC 60068-2-82/JEDEC JESD 201
Contact material	Cu alloy
Surface characteristics	hot-dip tin-plated
Metal surface terminal point (top layer)	Tin (4 - 8 μm Sn)
Metal surface contact area (top layer)	Tin (4 - 8 μm Sn)

Material data - housing

Color (Housing)	black (9005)
Insulating material	PA
Insulating material group	I
CTI according to IEC 60112	600
Flammability rating according to UL 94	V0
Glow wire flammability index GWFI according to EN 60695-2-12	850
Glow wire ignition temperature GWIT according to EN 60695-2-13	775
Temperature for the ball pressure test according to EN 60695-10-2	125 °C

Dimensions

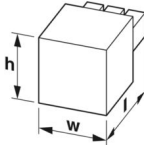
Dimensional drawing	
Pitch	7.62 mm
Width [w]	30.43 mm
Height [h]	19.7 mm
Length [l]	35.25 mm

Mounting

PC 5/ 4-ST1-7,62 BK - PCB connector



1783665

<https://www.phoenixcontact.com/us/products/1783665>

Drive form screw head	Slotted Phillips recess (H1L)
Drive form screw head	Slotted Phillips recess (H1L)

Notes

Notes on operation	In accordance with IEC 61984, COMBICON connectors have no switching power (COC). During designated use, they must not be plugged in or disconnected when carrying voltage or under load.
--------------------	--

Mechanical tests

Test for conductor damage and slackening

Specification	IEC 60999-1:1999-11
Result	Test passed

Pull-out test

Specification	IEC 60999-1:1999-11
Conductor cross section/conductor type/tractive force setpoint/actual value	0.2 mm ² / solid / > 10 N
	0.2 mm ² / flexible / > 10 N
	10 mm ² / solid / > 90 N
	6 mm ² / flexible / > 80 N

Insertion and withdrawal forces

Result	Test passed
No. of cycles	50
Insertion strength per pos. approx.	8 N
Withdraw strength per pos. approx.	6 N

Torque test

Specification	IEC 60999-1:1999-11
---------------	---------------------

Resistance of inscriptions

Specification	IEC 60068-2-70:1995-12
Result	Test passed

Polarization and coding

Specification	IEC 60512-13-5:2006-02
Result	Test passed

Visual inspection

Specification	IEC 60512-1-1:2002-02
Result	Test passed

Dimension check

Specification	IEC 60512-1-2:2002-02
Result	Test passed

Environmental and real-life conditions

Vibration test

PC 5/ 4-ST1-7,62 BK - PCB connector



1783665

<https://www.phoenixcontact.com/us/products/1783665>

Specification	IEC 60068-2-6:2007-12
Frequency	10 - 150 - 10 Hz
Sweep speed	1 octave/min
Amplitude	0.35 mm (10 Hz ... 60.1 Hz)
Sweep speed	5g (60.1 Hz ... 150 Hz)
Test duration per axis	2.5 h

Durability test

Specification	IEC 60512-5:1992-08
Impulse withstand voltage at sea level	7.3 kV
Contact resistance R ₁	0.45 mΩ
Contact resistance R ₂	0.6 mΩ
Insertion/withdrawal cycles	50

Climatic test

Specification	ISO 6988:1985-02
Corrosive stress	0.2 dm ³ SO ₂ on 300 dm ³ /40 °C/1 cycle
Thermal stress	100 °C/168 h
Power-frequency withstand voltage	3.31 kV

Ambient conditions

Ambient temperature (operation)	-40 °C ... 100 °C (dependent on the derating curve)
Ambient temperature (storage/transport)	-40 °C ... 70 °C
Relative humidity (storage/transport)	30 % ... 70 %
Ambient temperature (assembly)	-5 °C ... 100 °C

Electrical tests

Thermal test | Test group C

Specification	IEC 60512-5-1:2002-02
Tested number of positions	12

Insulation resistance

Specification	IEC 60512-3-1:2002-02
Insulation resistance, neighboring positions	>10 ¹² Ω

Air clearances and creepage distances |

Specification	IEC 60664-1:2007-04
Insulating material group	I
Comparative tracking index (IEC 60112)	CTI 600
Rated insulation voltage (III/3)	1000 V
Rated surge voltage (III/3)	8 kV
minimum clearance value - non-homogenous field (III/3)	8 mm
minimum creepage distance (III/3)	12.5 mm
Rated insulation voltage (III/2)	1000 V
Rated surge voltage (III/2)	8 kV
minimum clearance value - non-homogenous field (III/2)	8 mm

PC 5/ 4-ST1-7,62 BK - PCB connector



1783665

<https://www.phoenixcontact.com/us/products/1783665>

minimum creepage distance (III/2)	8 mm
Rated insulation voltage (II/2)	1000 V
Rated surge voltage (II/2)	6 kV
minimum clearance value - non-homogenous field (II/2)	5.5 mm
minimum creepage distance (II/2)	5.5 mm

Packaging specifications

Type of packaging	packed in cardboard
-------------------	---------------------

Drawings

Diagram

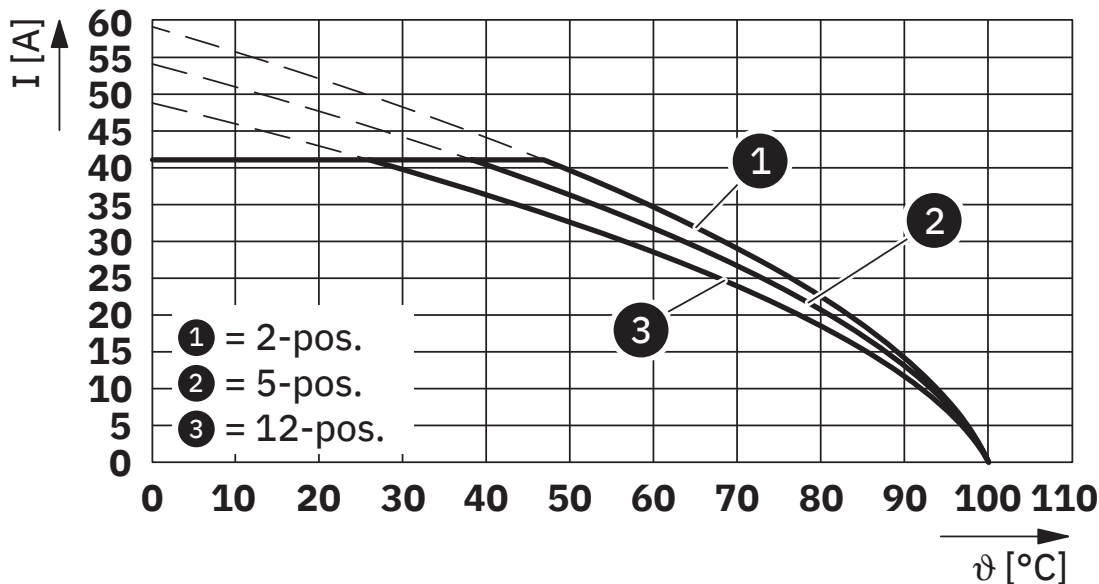

Type: PC 5/...-ST1-7,62 with DFK-PC 5/...-ST-7,62

Diagram

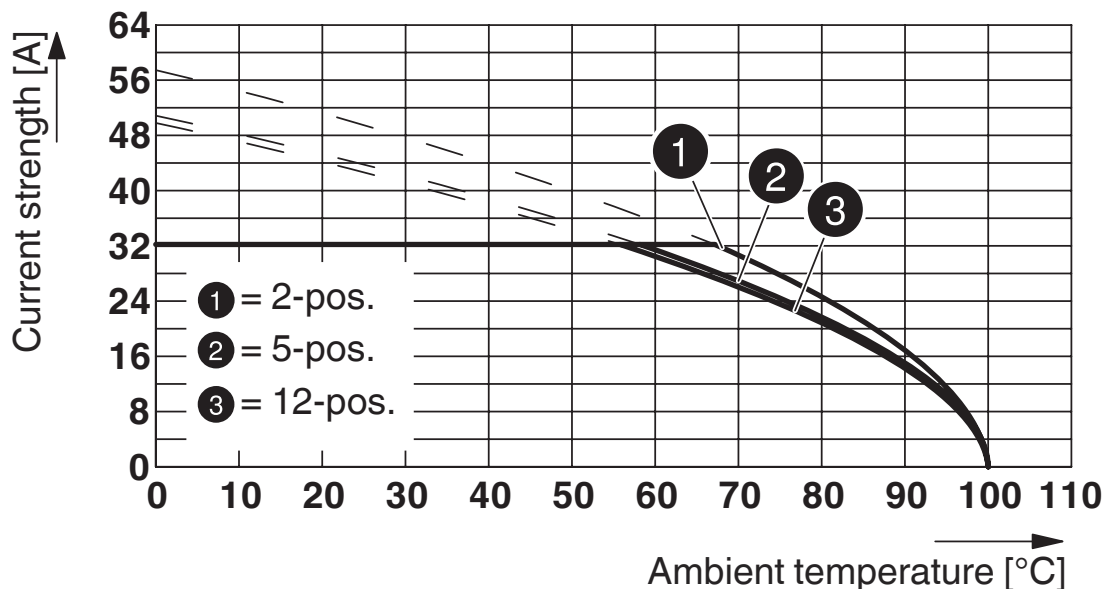

Type: PC 5/...-ST(F)1-7,62 with PC 5/...-GU(F)-7,62
 Conductor cross section: 6 mm²

1783665

<https://www.phoenixcontact.com/us/products/1783665>

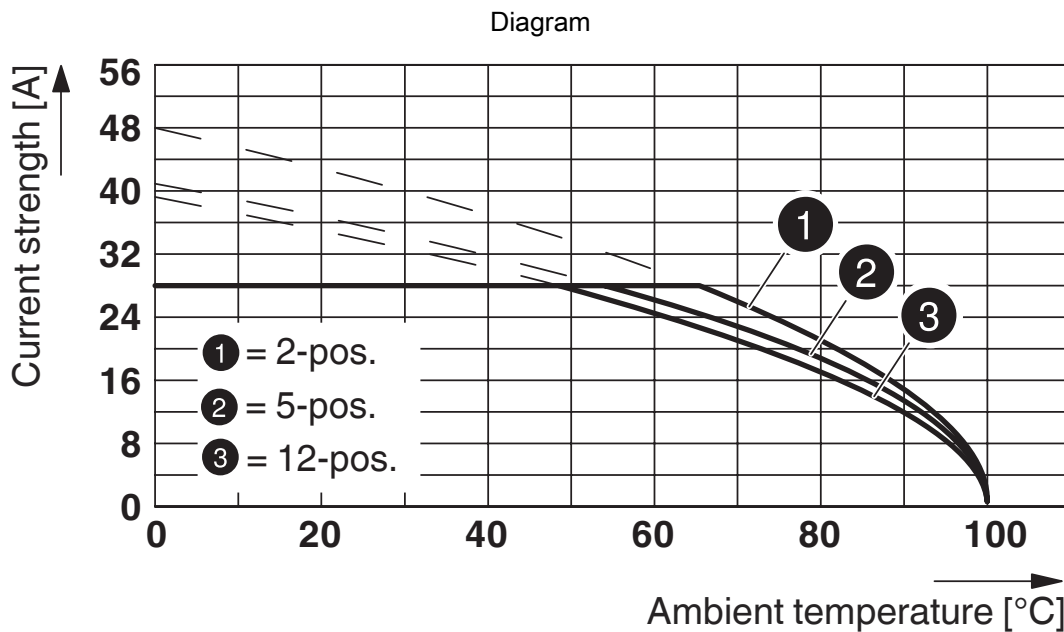

Derating curve for: PC 5/...-ST1-7,62 with PCV 4/...-G-7,62
 Conductor cross section: 4 mm²

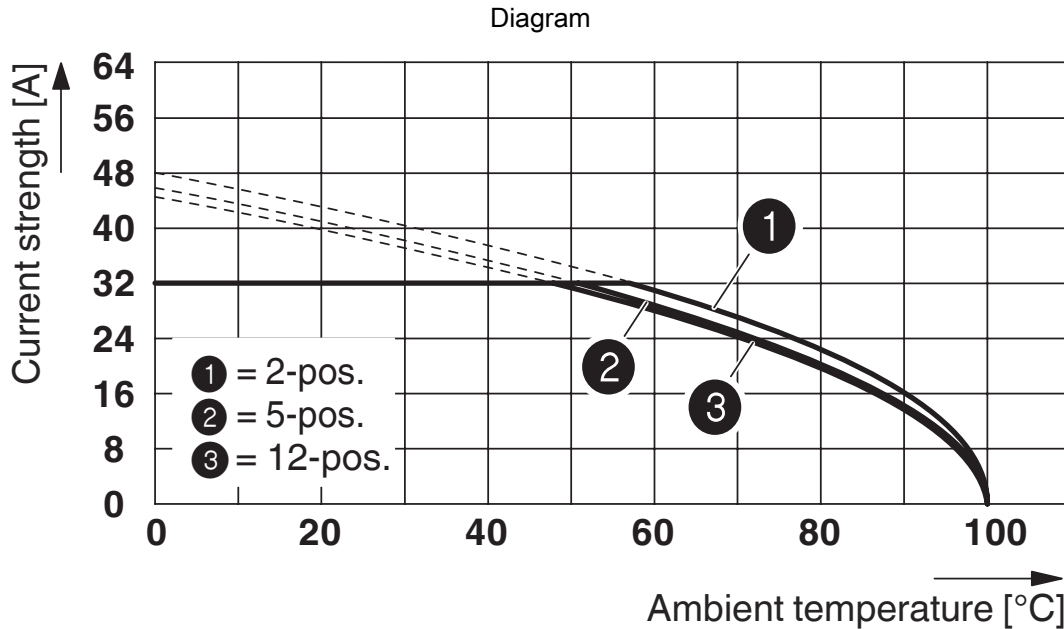

Derating curve for: PC 5/...-ST1-7,62 with PCV 5/...-G-7,62
 Conductor cross section: 6 mm²

PC 5/ 4-ST1-7,62 BK - PCB connector



1783665

<https://www.phoenixcontact.com/us/products/1783665>

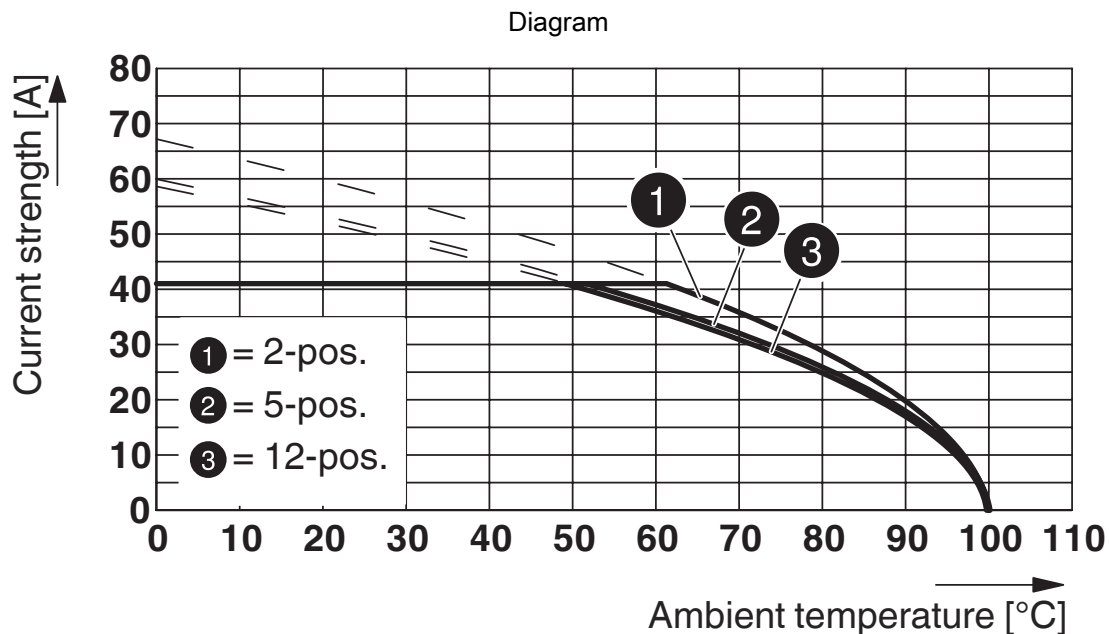

Type: PC 5/...-ST1-7,62 with PC 5/...-GU-7,62 P26 THT R..
 Conductor cross section: 10 mm²

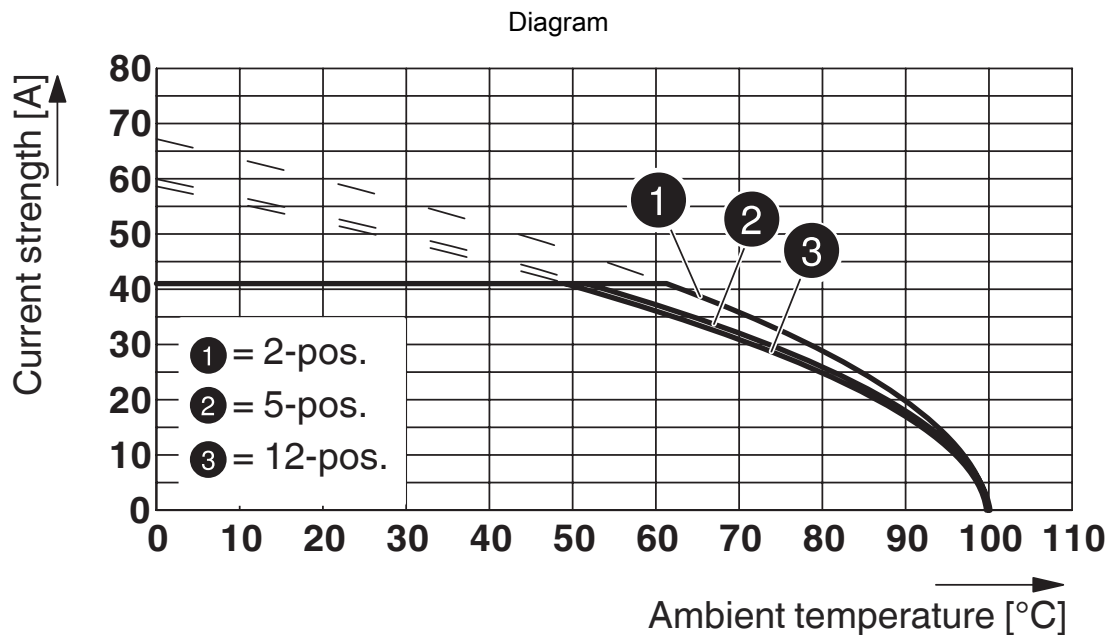

Type: PC 5/...-ST(F)1-7,62 with PC 5/...-G(F)U-7,62
 Conductor cross section: 10 mm²

1783665

<https://www.phoenixcontact.com/us/products/1783665>

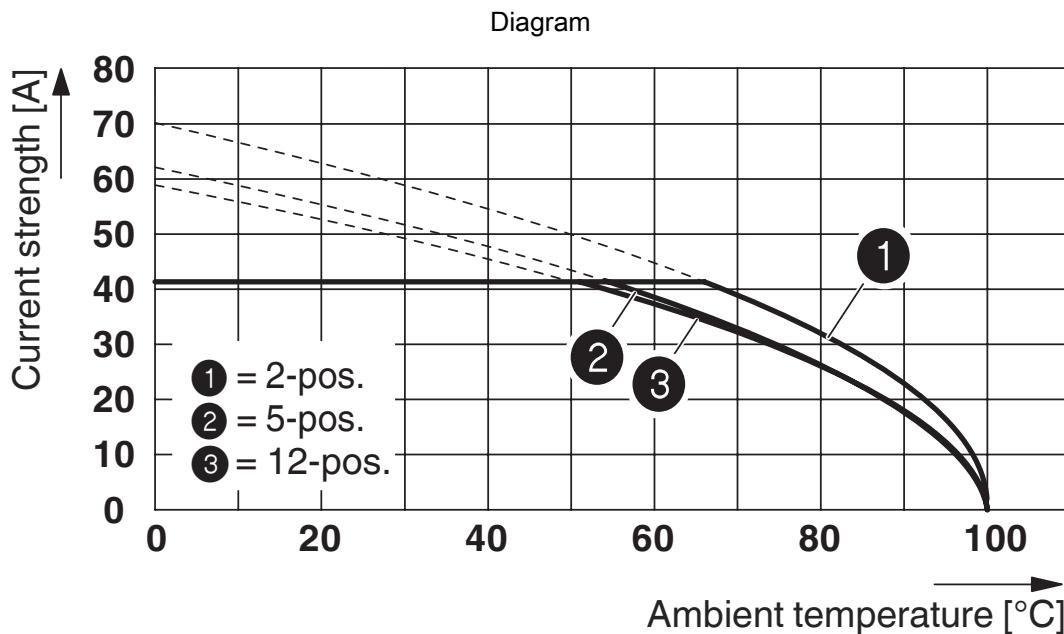

Derating curve for: PC 5/...-ST1-7,62 with PCV 5/...-G-7,62
 Conductor cross section: 10 mm²

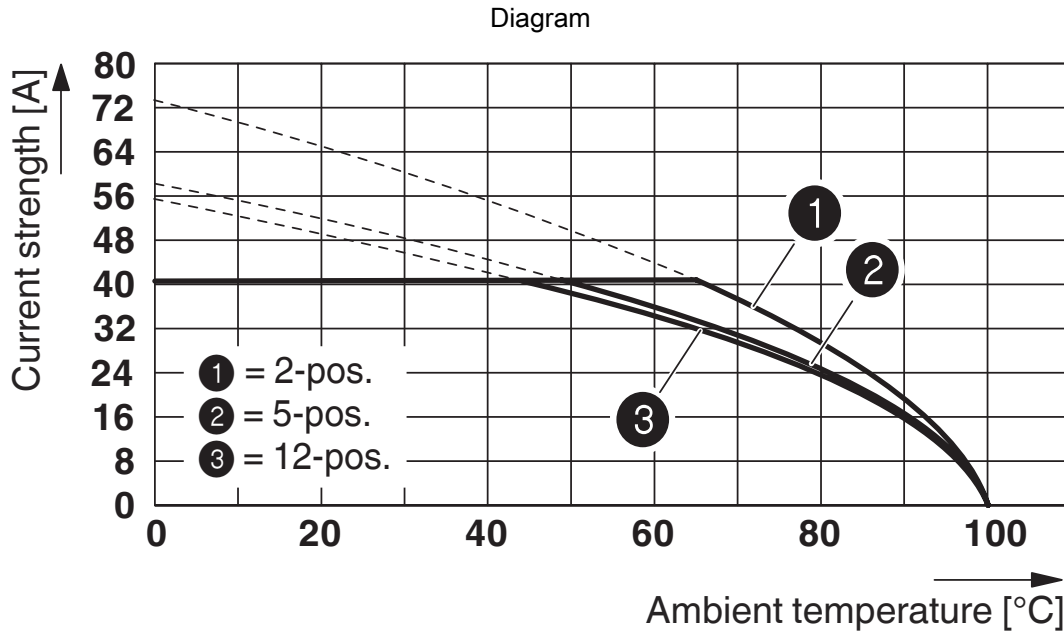

Derating curve for: PC 5/...-ST1-7,62 with PC 5/...-G-7,62
 Conductor cross section: 10 mm²

PC 5/ 4-ST1-7,62 BK - PCB connector



1783665

<https://www.phoenixcontact.com/us/products/1783665>

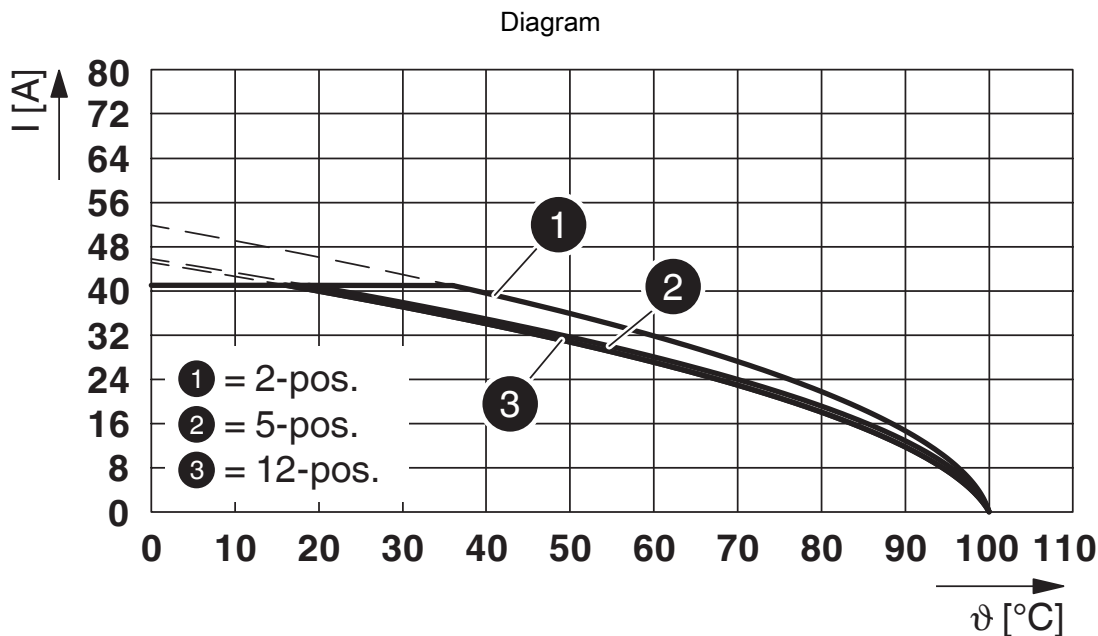

Type: PC 5/...-ST1-7,62 with IPC 5/...-ST-7,62

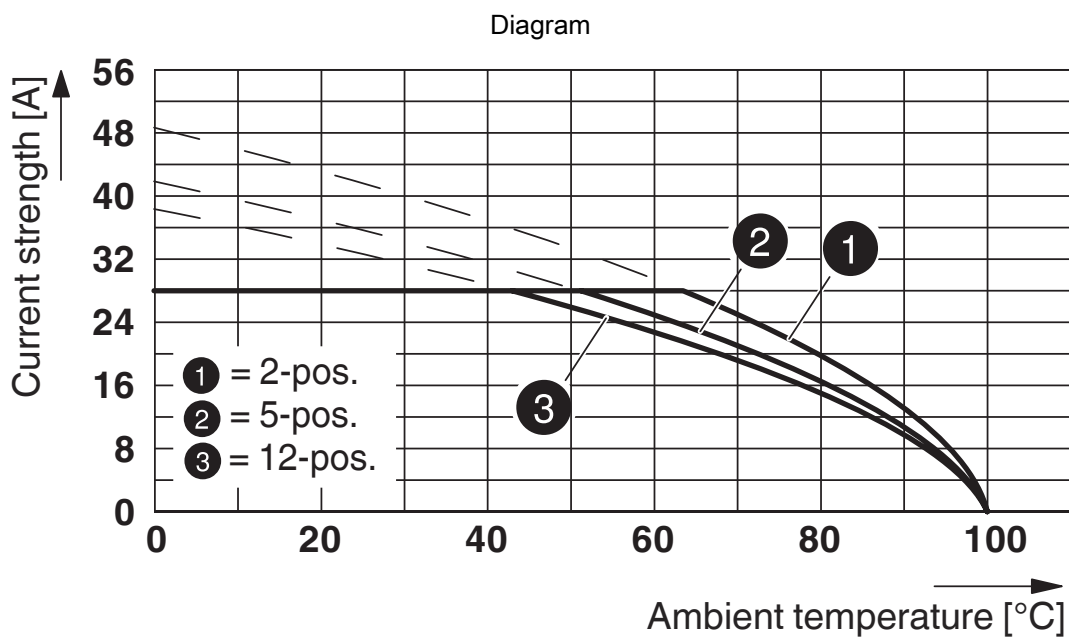

Derating curve for: PC 5/...-ST1-7,62 with PC 4/...-G-7,62
 Conductor cross section: 4 mm²

1783665

<https://www.phoenixcontact.com/us/products/1783665>

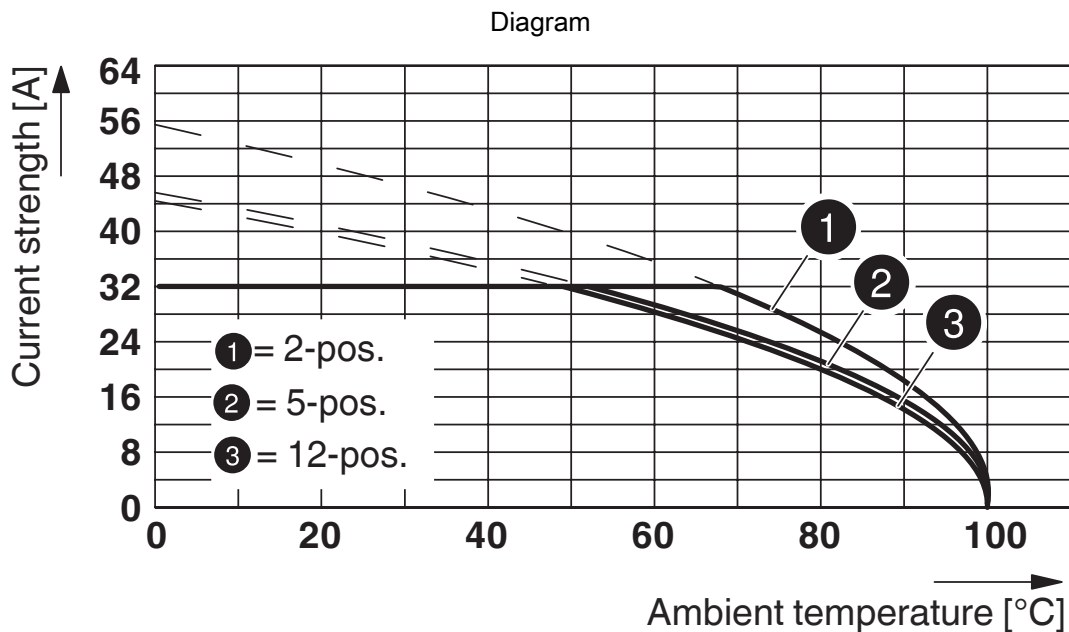

Derating curve for: PC 5/...-ST1-7,62 with PCV 4/...-G-7,62
 Conductor cross section: 6 mm²

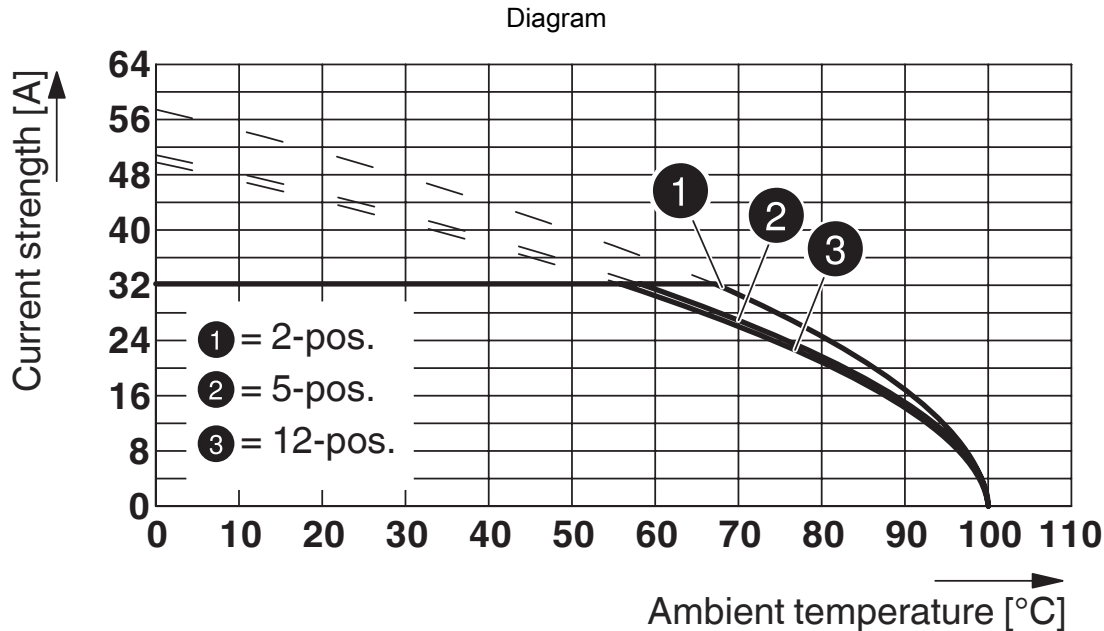

Type: PC 5/...-ST1-7,62 with PC 5/...-GU-7,62 P26 THT R..
 Conductor cross section: 6 mm²

1783665

<https://www.phoenixcontact.com/us/products/1783665>

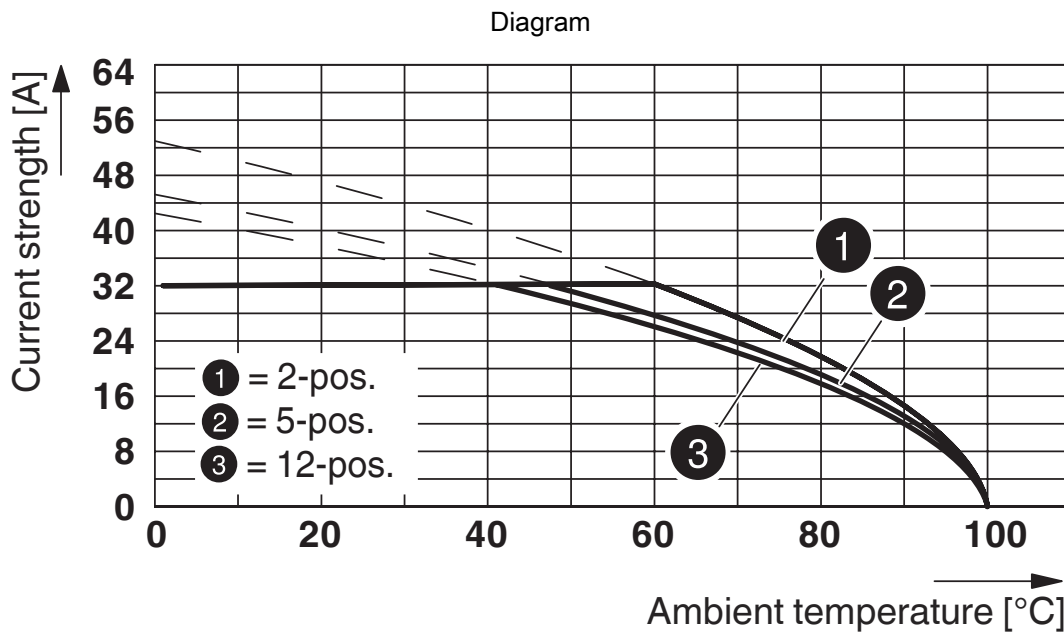

Derating curve for: PC 5/...-ST1-7,62 with PC 4/...-G-7,62
 Conductor cross section: 6 mm²

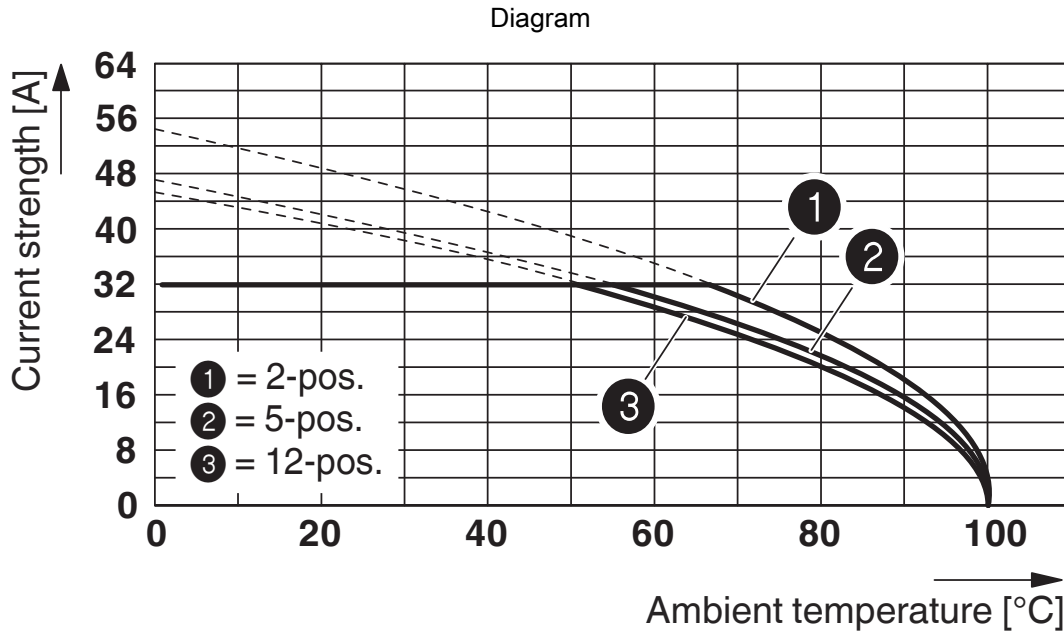

Derating curve for: PC 5/...-ST1-7,62 with PC 5/...-G-7,62
 Conductor cross section: 6 mm²

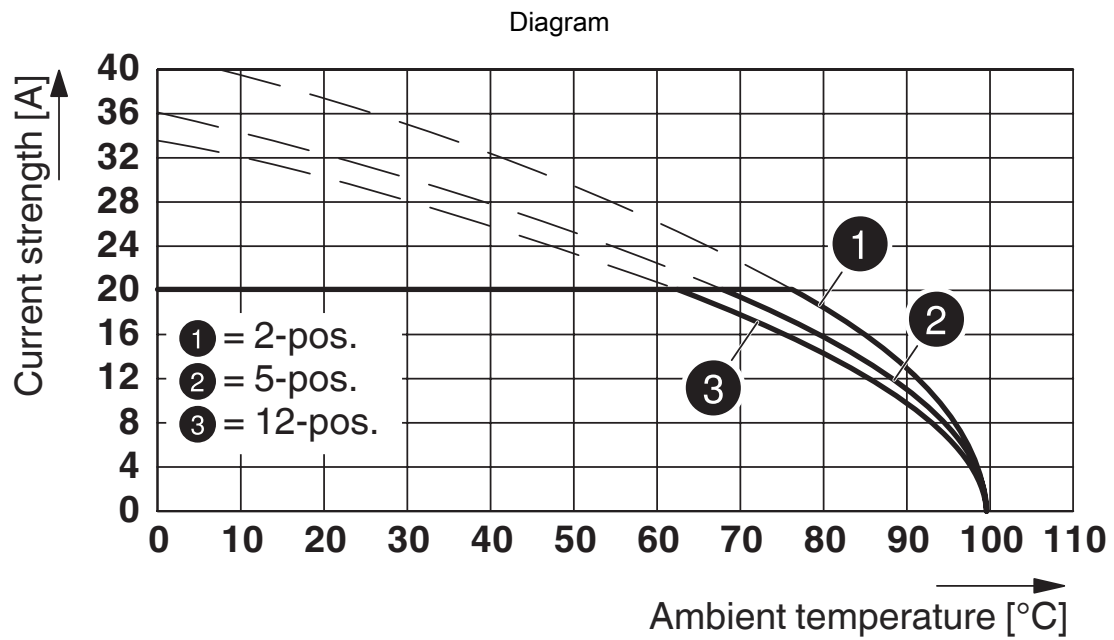

Type: PC 5/...-ST1-7,62 with PCVK 4-7,62

PC 5/ 4-ST1-7,62 BK - PCB connector



1783665

<https://www.phoenixcontact.com/us/products/1783665>

Approvals

To download certificates, visit the product detail page: <https://www.phoenixcontact.com/us/products/1783665>

 cULus Recognized Approval ID: E60425-19920722		Nominal voltage U_N	Nominal current I_N	Cross section AWG	Cross section mm^2
Use group B					
Multi-conductor connection	600 V	41 A	24 - 12	-	
Screw connection	600 V	41 A	24 - 8	-	
Use group C					
Multi-conductor connection	600 V	41 A	24 - 12	-	
Screw connection	600 V	41 A	24 - 8	-	

PC 5/ 4-ST1-7,62 BK - PCB connector



1783665

<https://www.phoenixcontact.com/us/products/1783665>

Classifications

ECLASS

ECLASS-11.0	27460202
ECLASS-12.0	27460202
ECLASS-13.0	27460202

ETIM

ETIM 8.0	EC002638
----------	----------

UNSPSC

UNSPSC 21.0	39121400
-------------	----------

PC 5/ 4-ST1-7,62 BK - PCB connector



1783665

<https://www.phoenixcontact.com/us/products/1783665>

Environmental product compliance

EU RoHS

Fulfills EU RoHS substance requirements	Yes, No exemptions
---	--------------------

China RoHS

Environment friendly use period (EFUP)	EFUP-E
	No hazardous substances above the limits

EU REACH SVHC

REACH candidate substance (CAS No.)	No substance above 0.1 wt%
-------------------------------------	----------------------------

PC 5/ 4-ST1-7,62 BK - PCB connector



1783665

<https://www.phoenixcontact.com/us/products/1783665>

Accessories

SZS 0,6X3,5 - Screwdriver

1205053

<https://www.phoenixcontact.com/us/products/1205053>



Actuation tool, for ST terminal blocks, insulated, also suitable for use as a bladed screwdriver, size: 0.6 x 3.5 x 100 mm, 2-component grip, with non-slip grip

CP-PC RD - Coding profile

1701967

<https://www.phoenixcontact.com/us/products/1701967>



Coding profile, for plugging into the coding ribs of the plug at a later date, insulating material, color: Red

Phoenix Contact 2024 © - all rights reserved

<https://www.phoenixcontact.com>

Phoenix Contact USA

586 Fulling Mill Road

Middletown, PA 17057, United States

(+717) 944-1300

info@phoenixcon.com