

NOTES:

1. $\text{\textcircled{C}}$ REPRESENTS A CRITICAL DIMENSION.
2. MINIMUM PUSHOUT FORCE TO BE: 2 LB
3. ORIENTATION OF PART OR PAD IN -TR MAY VARY DEPENDING ON POCKET.
4. MAXIMUM CUT FLASH: .030[0.76] ON TAIL AND POST
5. DUE TO THE HIGH AMOUNT OF INSERTION FORCE NEEDED, THE -LC OPTION IS NOT COMPATIBLE WITH AUTO PLACEMENT. SAMTEC RECOMMENDS MANUAL PLACEMENT FOR ALL ASSEMBLIES WITH THE -LC OPTION.
6. AVAILABLE ON -01 LEAD STYLE ONLY.
MATES WITH SSW, SSQ, SSM, BCS, ESW, ESQ.
7. 50 POSITION PARTS ARE ONLY AVAILABLE FOR INTERNAL SAMTEC USE.
8. NOTE DELETED.
9. STANDARD PACKAGING IN TUBES.
-31 THRU -36 POSITION PARTS MUST SHIP IN TUBES.
10. LEADS MAY NOT BE VISIBLE FOR CUSTOMER VISUAL INSPECTION ON SMALLER POSITION PARTS WHEN USED WITH -P OPTION.
11. ORDERS TO BE PACKAGED ACCORDING TO THE SAMTEC PACKAGING EFFICIENCY STANDARDS (SPES) FOUND ON WWW.SAMTEC.COM
12. LABEL TO BE ATTACHED TO EACH REEL.

DO NOT SCALE FROM THIS PRINT

TSM-1XX-XX-XXX-SH-XX-XXX-X-XX

NO OF POSITIONS
-02 THRU -36,
-50 (SEE NOTE 7)

LEAD STYLE
SEE TABLE 1

PLATING SPECIFICATION

- T: MATTE TIN ON ENTIRE PIN
- S: 30 μ " SELECTIVE GOLD IN CONTACT AREA, MATTE TIN ON TAIL
- G: 10 μ " SELECTIVE GOLD IN CONTACT AREA, 3 μ " SELECTIVE GOLD ON TAIL
- L: 10 μ " SELECTIVE GOLD IN CONTACT AREA, MATTE TIN ON TAIL
- F: 3 μ " SELECTIVE GOLD IN CONTACT AREA, MATTE TIN ON TAIL
- H: 30 μ " SELECTIVE GOLD IN CONTACT AREA, 3 μ " SELECTIVE GOLD ON TAIL
- TL: TIN/LEAD (90/10 \pm 5%) CONTACT AND TAIL (-01 LEAD STYLE ONLY)
- STL: 30 μ " SELECTIVE GOLD IN CONTACT AREA, TIN/LEAD (90/10 \pm 5%) TAIL (LEAD STYLE -01 & -02 ONLY)
- TM: MATTE TIN CONTACT AND TAIL
- SM: 30 μ " SELECTIVE GOLD IN CONTACT AREA, MATTE TIN ON TAIL
- LM: 10 μ " SELECTIVE GOLD IN CONTACT AREA, MATTE TIN ON TAIL
- FM: 3 μ " SELECTIVE GOLD IN CONTACT AREA, MATTE TIN ON TAIL
- SS: 30 μ " STRIPE SELECTIVE GOLD IN CONTACT AREA, MATTE TIN TAIL (SEE NOTE 6)

PACKAGING OPTION

- BLANK: TUBES (SEE NOTE 9 & FIG 5)
- TR: TAPE & REEL (-02 THRU -30 POSITION) (SEE NOTES 11, & 12)
- FR: FULL REEL QTY TAPE & REEL (-02 THRU -30 POSITION) (SEE NOTES 11 & 12)

PAD OPTION

- P: PICK & PLACE PAD (SEE FIG 3)
USE PPP-08 (-04 THRU -36 POSITION OR -02 & -03 POSITION WITH -TR & -FR ONLY)
- K: POLYIMIDE FILM (SEE FIG 6, SHT 2) (-04 THRU -36 POSITION) (-02 & -03 POSITION WITH -TR & -FR ONLY) (USE K-DOT-.197-.344-.005)

POLARIZATION

- XXX: POLARIZED POSITION SPECIFY OMITTED PIN

HOLD DOWN OPTION

- LC: LOCKING CLIP (SEE FIG 1) (SEE NOTE 5)
USE LC-09-TM (-03 THRU -36 POS USE 2 PER STRIP) (-02 POS USE 1 PER STRIP) (USE TSM-50-SHU)
- A: ALIGNMENT PIN (USE TSM-XX-SHU BODY FOR MOLDED -A PINS, POS -02 THRU -50, SEE FIG 2, SHT 2) (USE TSM-50-SHU BODY FOR STAKED -A PINS, POS -04 THRU -50, SEE FIG 4, SHT 2)
LEAVE BLANK FOR NO HOLD DOWN OPTION (USE TSM-50-SHU, SEE FIG 1, CAN BE CUT TO POSITION) N/A ON STYLE -03

ROW SPECIFICATION

- SH: SINGLE HORIZONTAL

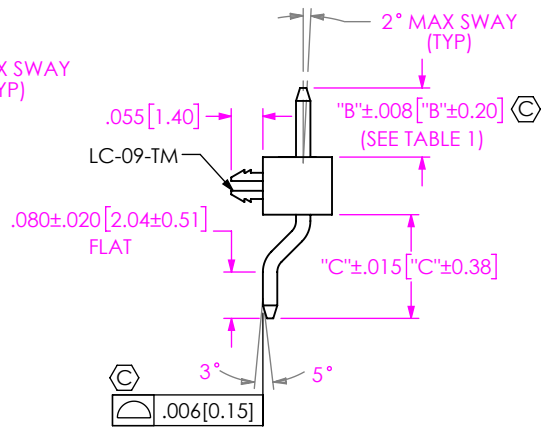
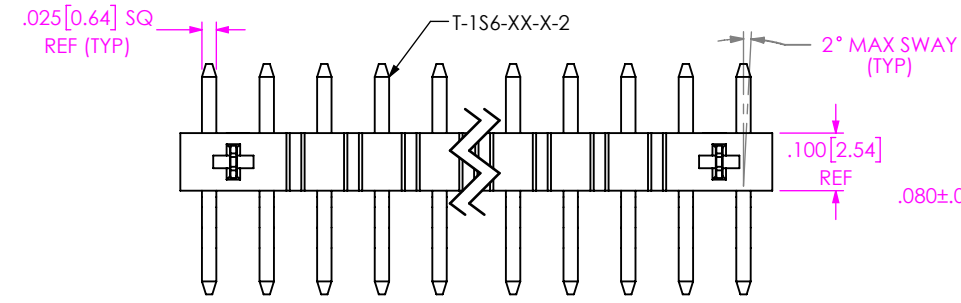
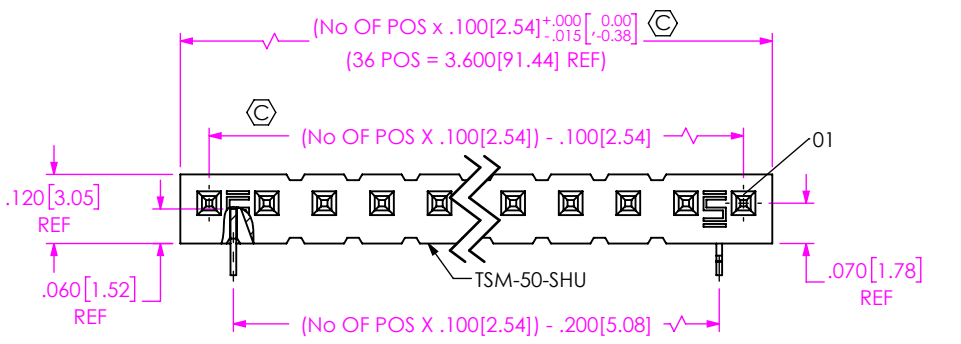

LEAD STYLE	"B"	TERMINAL	"C"
-01	.230 [5.84]	T-1S6-08-X-2	.180 [4.57]
-02	.320 [8.13]	T-1S6-15-X-2	.190 [4.83]
-03	.420 [10.67]	T-1S6-09-X-2	.190 [4.83]
-04	.120 [3.05]	T-1S6-07-X-2	.190 [4.83]

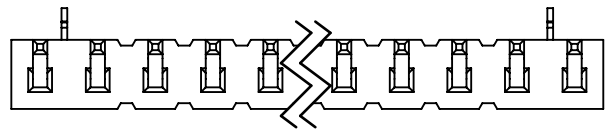

FIG 1
-LC: LOCKING CLIP OPTION
CLIPS N/A WITH -A OPTION

UNLESS OTHERWISE SPECIFIED, DIMENSIONS ARE IN INCHES. TOLERANCES ARE:
DECIMALS ANGLES
.XX: ±.01 [0.3] 2°
.XXX: ±.005 [0.13]
.XXXX: ±.0020 [0.051]

PROPRIETARY NOTE
THIS DOCUMENT CONTAINS CONFIDENTIAL AND PROPRIETARY INFORMATION AND ALL DESIGN, MANUFACTURING, REPRODUCTION, USE, PATENT RIGHTS AND SALES RIGHTS ARE EXPRESSLY RESERVED BY SAMTEC, INC. THIS DOCUMENT SHALL NOT BE DISCLOSED, IN WHOLE OR PART, TO ANY UNAUTHORIZED PERSON OR ENTITY NOR REPRODUCED, TRANSFERRED OR INCORPORATED IN ANY OTHER PROJECT IN ANY MANNER WITHOUT THE EXPRESS WRITTEN CONSENT OF SAMTEC, INC.



520 PARK EAST BLVD, NEW ALBANY, IN 47150
PHONE: 812-944-6733 FAX: 812-948-5047
e-Mail info@SAMTEC.com code 55322

MATERIAL: INSULATOR: LCP, COLOR: BLACK TERMINAL: PHOSPHER BRONZE	DO NOT SCALE DRAWING SHEET SCALE: 3:1	DESCRIPTION: TERMINAL STRIP SINGLE SURFACE MOUNT DWG. NO. TSM-1XX-XX-XXX-SH-XX-XXX-X-XX
BY: REIDINGER 07/19/1991		SHEET 1 OF 2

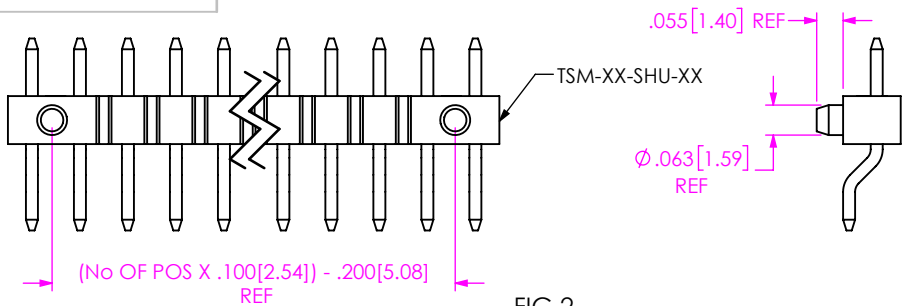

FIG 2
-A: ALIGNMENT PIN OPTION (MOLDED)
DIFFERENT AS SHOWN, OTHERWISE SAME AS FIG 1

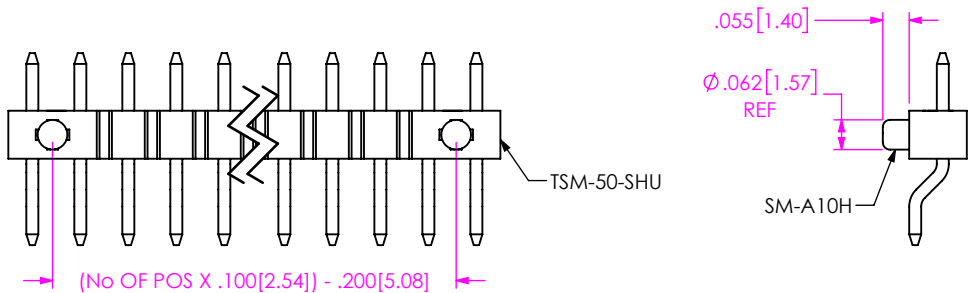

FIG 4
-A: ALIGNMENT PIN OPTION (STAKED)
DIFFERENT AS SHOWN, OTHERWISE SAME AS FIG 1

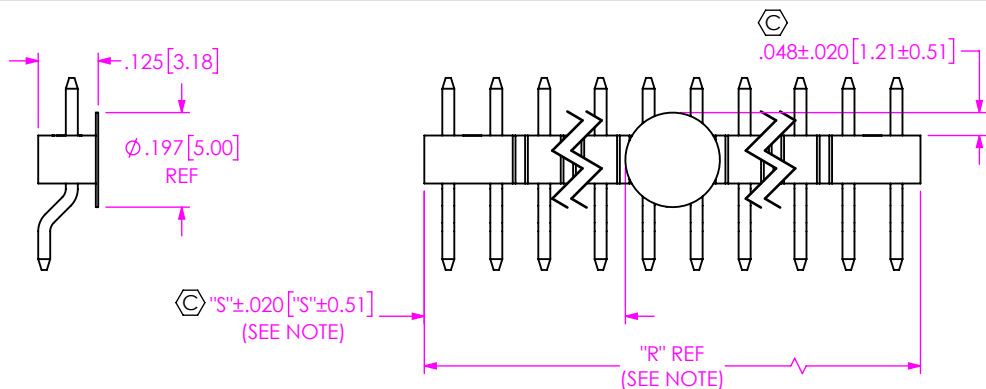

FIG 6
-K: POLYIMIDE FILM PAD OPTION
"R" = USED MEASURED DIMENSIONS
"S" = ("R" - .1969 [5.000])/2

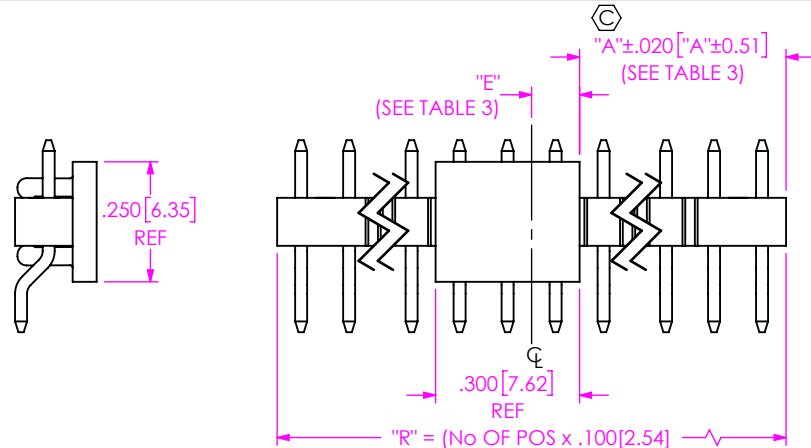
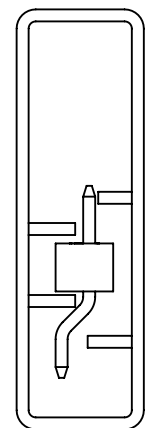
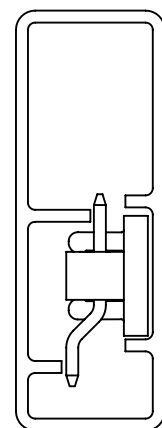

FIG 3
-P: PICK & PLACE PAD OPTION
PLACE PPP-08 ON CL AS SHOWN
DIFFERENT AS SHONW, OTHERWISE SAME AS FIG 1

TABLE 3		
POS	"A"	"E"
ODD	("R" - .300 [7.26])/2	.150 [3.81]
EVEN	("R" - .300 [7.26])/2 + .050 [1.27]	.100 [2.54]



PT-TSM002-SH-K
USE TP-24



PT-TSM003-SH-P
TP-09

FIG 5
PACKAGING
PARTS WITHOUT PLASTIC PAD USE PT-TSM002-SH-K
PARTS WITH PLASTIC PAD USE PT-TSM003-SH-P

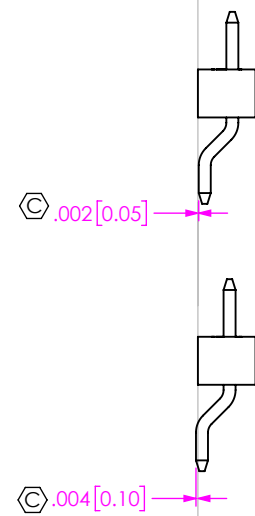

FIG 7
-SH: SURFACE MOUNT DIAGRAM

PROPRIETARY NOTE
THIS DOCUMENT CONTAINS CONFIDENTIAL AND PROPRIETARY INFORMATION AND ALL DESIGN, MANUFACTURING, REPRODUCTION, USE, PATENT RIGHTS AND SALES RIGHTS ARE EXPRESSLY RESERVED BY SAMTEC, INC. THIS DOCUMENT SHALL NOT BE DISCLOSED, IN WHOLE OR PART, TO ANY UNAUTHORIZED PERSON OR ENTITY NOR REPRODUCED, TRANSFERRED OR INCORPORATED IN ANY OTHER PROJECT IN ANY MANNER WITHOUT THE EXPRESS WRITTEN CONSENT OF SAMTEC, INC.

DO NOT SCALE DRAWING
SHEET SCALE: 2.5:1

samtec
520 PARK EAST BLVD, NEW ALBANY, IN 47150
PHONE: 812-944-6733 FAX: 812-948-5047
e-Mail: info@SAMTEC.com code 55322

DESCRIPTION:
TERMINAL STRIP SINGLE SURFACE MOUNT

DWG. NO.
TSM-1XX-XX-XXX-SH-XX-XXX-X-XX

BY: REIDINGER 07/19/1991 SHEET 2 OF 2