

# NCP5106A, NCP5106B

## High Voltage, High and Low Side Driver

The NCP5106 is a high voltage gate driver IC providing two outputs for direct drive of 2 N-channel power MOSFETs or IGBTs arranged in a half-bridge configuration version B or any other high-side + low-side configuration version A.

It uses the bootstrap technique to ensure a proper drive of the high-side power switch. The driver works with 2 independent inputs.

### Features

- High Voltage Range: Up to 600 V
- dV/dt Immunity  $\pm 50$  V/nsec
- Negative Current Injection Characterized Over the Temperature Range
- Gate Drive Supply Range from 10 V to 20 V
- High and Low Drive Outputs
- Output Source / Sink Current Capability 250 mA / 500 mA
- 3.3 V and 5 V Input Logic Compatible
- Up to  $V_{CC}$  Swing on Input Pins
- Extended Allowable Negative Bridge Pin Voltage Swing to  $-10$  V for Signal Propagation
- Matched Propagation Delays Between Both Channels
- Outputs in Phase with the Inputs
- Independent Logic Inputs to Accommodate All Topologies (Version A)
- Cross Conduction Protection with 100 ns Internal Fixed Dead Time (Version B)
- Under  $V_{CC}$  LockOut (UVLO) for Both Channels
- Pin-to-Pin Compatible with Industry Standards
- These are Pb-Free Devices

### Typical Applications

- Half-Bridge Power Converters
- Any Complementary Drive Converters (Asymmetrical Half-Bridge, Active Clamp) (A Version Only).
- Full-Bridge Converters



**ON Semiconductor®**

[www.onsemi.com](http://www.onsemi.com)

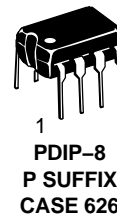

### MARKING DIAGRAMS

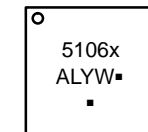
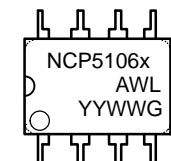
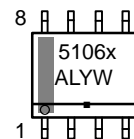

NCP5106 = Specific Device Code  
 x = A or B version  
 A = Assembly Location  
 L or WL = Wafer Lot  
 Y or YY = Year  
 W or WW = Work Week  
 G or ▪ = Pb-Free Package

(Note: Microdot may be in either location)

### PINOUT INFORMATION

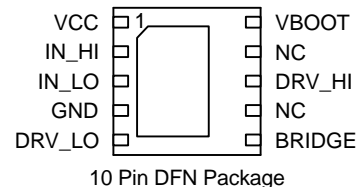
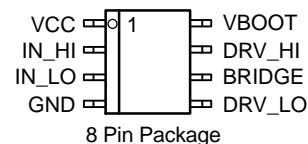

### ORDERING INFORMATION

See detailed ordering and shipping information on page 16 of this data sheet.

# NCP5106A, NCP5106B

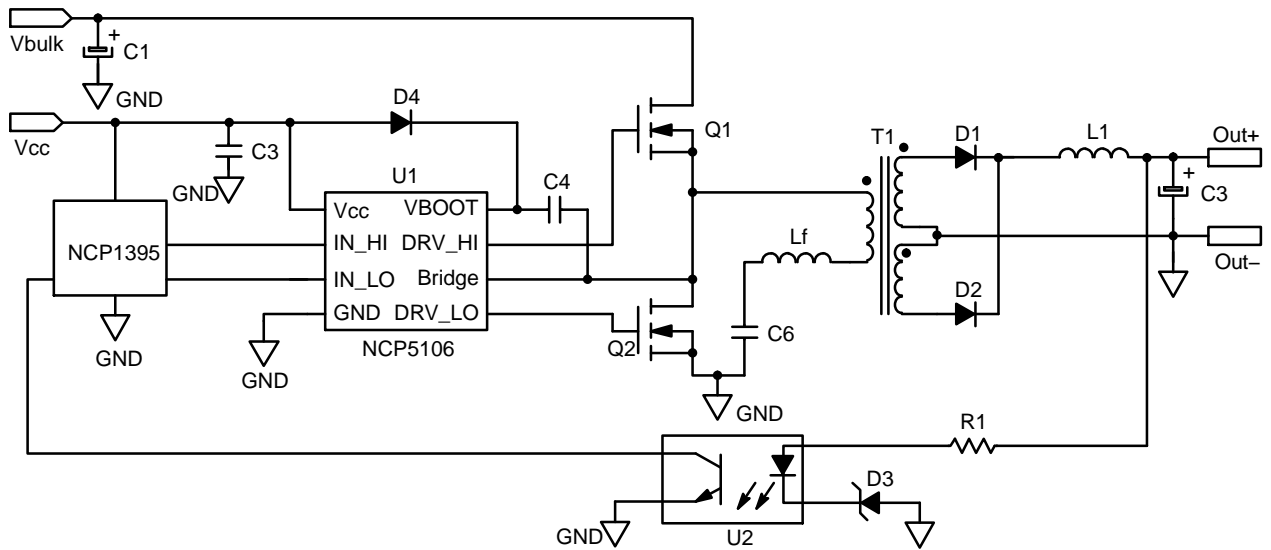

Figure 1. Typical Application Resonant Converter (LLC type)

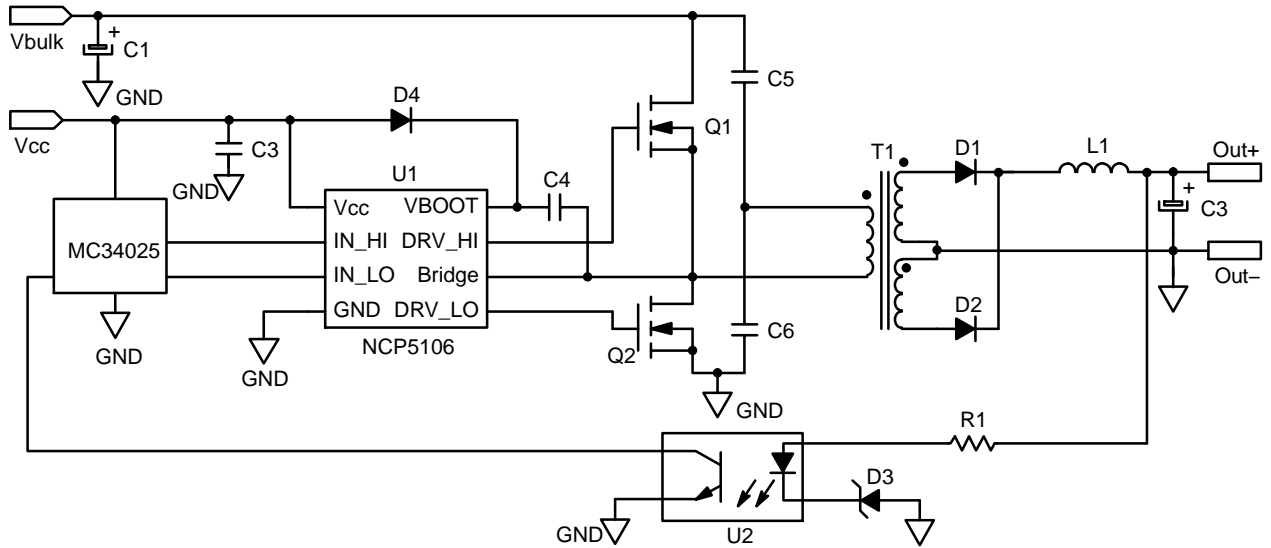
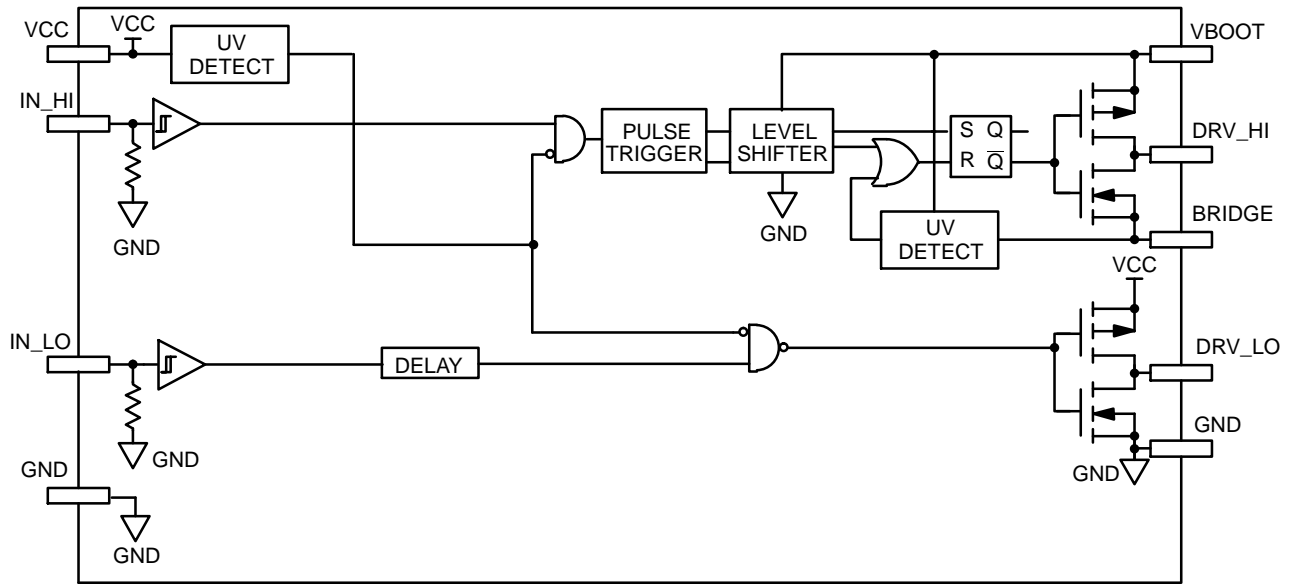
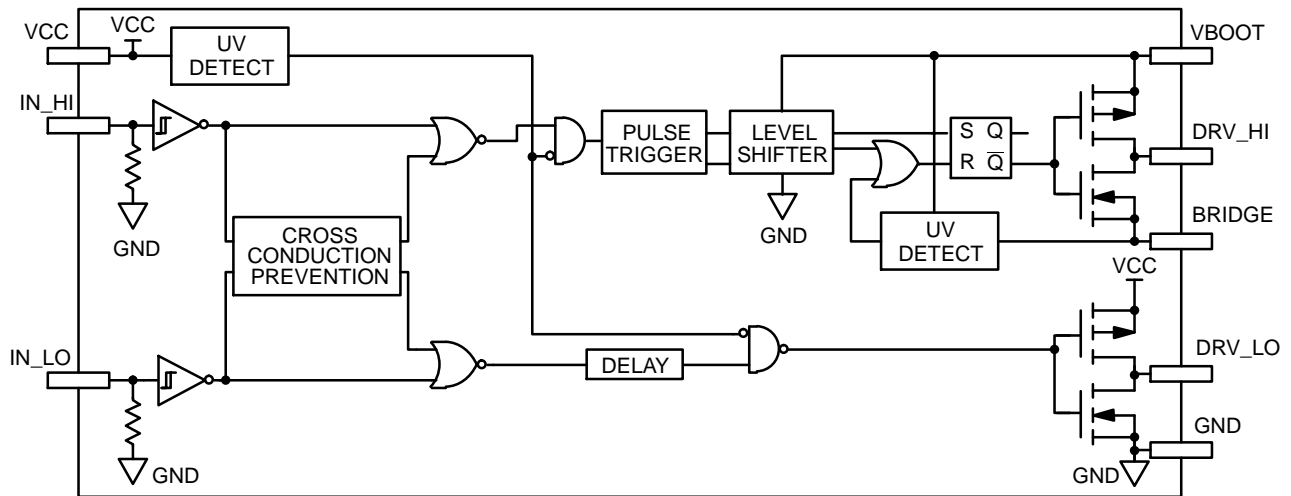

Figure 2. Typical Application Half Bridge Converter

## NCP5106A, NCP5106B



**Figure 3. Detailed Block Diagram: Version A**



**Figure 4. Detailed Block Diagram: Version B**

### PIN DESCRIPTION

Pin Name	Description
IN_HI	Logic Input for High Side Driver Output in Phase
IN_LO	Logic Input for Low Side Driver Output in Phase
GND	Ground
DRV_LO	Low Side Gate Drive Output
V <sub>CC</sub>	Low Side and Main Power Supply
V <sub>BOOT</sub>	Bootstrap Power Supply
DRV_HI	High Side Gate Drive Output
BRIDGE	Bootstrap Return or High Side Floating Supply Return
NC	Removed for creepage distance (DFN package only)

## NCP5106A, NCP5106B

### MAXIMUM RATINGS

Rating	Symbol	Value	Unit
$V_{CC}$	Main power supply voltage	-0.3 to 20	V
$V_{CC\_transient}$	Main transient power supply voltage: $I_{V_{CC\_max}} = 5 \text{ mA}$ during 10 ms	23	V
$V_{BRIDGE}$	VHV: High Voltage BRIDGE pin	-1 to 600	V
$V_{BRIDGE}$	Allowable Negative Bridge Pin Voltage for IN_LO Signal Propagation to DRV_LO (see characterization curves for detailed results)	-10	V
$V_{BOOT\_V_{BRIDGE}}$	VHV: Floating supply voltage	-0.3 to 20	V
$V_{DRV\_HI}$	VHV: High side output voltage	$V_{BRIDGE} - 0.3$ to $V_{BOOT} + 0.3$	V
$V_{DRV\_LO}$	Low side output voltage	-0.3 to $V_{CC} + 0.3$	V
$dV_{BRIDGE}/dt$	Allowable output slew rate	50	V/ns
$V_{IN\_XX}$	Inputs IN_HI, IN_LO	-1.0 to $V_{CC} + 0.3$	V
	ESD Capability:		
	- HBM model (all pins except pins 6-7-8 in 8 pins package or 11-12-13 in 14 pins package)	2	kV
	- Machine model (all pins except pins 6-7-8 in 8 pins package or 11-12-13 in 14 pins package)	200	V
	Latch up capability per JEDEC JESD78		
$R_{\theta JA}$	Power dissipation and Thermal characteristics PDIP-8: Thermal Resistance, Junction-to-Air SO-8: Thermal Resistance, Junction-to-Air DFN10 4x4: Thermal Resistance, Junction-to-Ambient 1 Oz Cu 50 mm <sup>2</sup> Printed Circuit Copper Clad	100 178 162	°C/W
$T_{ST}$	Storage Temperature Range	-55 to +150	°C
$T_{J\_max}$	Maximum Operating Junction Temperature	+150	°C

Stresses exceeding those listed in the Maximum Ratings table may damage the device. If any of these limits are exceeded, device functionality should not be assumed, damage may occur and reliability may be affected.

# NCP5106A, NCP5106B

**ELECTRICAL CHARACTERISTIC** ( $V_{CC} = V_{boot} = 15\text{ V}$ ,  $V_{GND} = V_{bridge}$ ,  $-40^{\circ}\text{C} < T_J < 125^{\circ}\text{C}$ , Outputs loaded with 1 nF)

Rating	Symbol	T <sub>J</sub> -40°C to 125°C			Units
		Min	Typ	Max	

## OUTPUT SECTION

Output high short circuit pulsed current $V_{DRV} = 0\text{ V}$ , $PW \leq 10\ \mu\text{s}$ (Note 1)	$I_{DRVsource}$	–	250	–	mA
Output low short circuit pulsed current $V_{DRV} = V_{CC}$ , $PW \leq 10\ \mu\text{s}$ (Note 1)	$I_{DRVsink}$	–	500	–	mA
Output resistor (Typical value @ 25°C) Source	$R_{OH}$	–	30	60	$\Omega$
Output resistor (Typical value @ 25°C) Sink	$R_{OL}$	–	10	20	$\Omega$
High level output voltage, $V_{BIAS} - V_{DRV\_XX}$ @ $I_{DRV\_XX} = 20\text{ mA}$	$V_{DRV\_H}$	–	0.7	1.6	V
Low level output voltage $V_{DRV\_XX}$ @ $I_{DRV\_XX} = 20\text{ mA}$	$V_{DRV\_L}$	–	0.2	0.6	V

## DYNAMIC OUTPUT SECTION

Turn-on propagation delay ( $V_{bridge} = 0\text{ V}$ )	$t_{ON}$	–	100	170	ns
Turn-off propagation delay ( $V_{bridge} = 0\text{ V}$ or $50\text{ V}$ ) (Note 2)	$t_{OFF}$	–	100	170	ns
Output voltage rise time (from 10% to 90% @ $V_{CC} = 15\text{ V}$ ) with 1 nF load	$t_r$	–	85	160	ns
Output voltage fall time (from 90% to 10% @ $V_{CC} = 15\text{ V}$ ) with 1 nF load	$t_f$	–	35	75	ns
Propagation delay matching between the High side and the Low side @ 25°C (Note 3)	$\Delta t$	–	20	35	ns
Internal fixed dead time (only valid for B version) (Note 4)	DT	65	100	190	ns
Minimum input width that changes the output	$t_{PW1}$	–	–	50	ns
Maximum input width that does not change the output	$t_{PW2}$	20 15	– –	– –	ns

## INPUT SECTION

Low level input voltage threshold	$V_{IN}$	–	–	0.8	V
Input pull-down resistor ( $V_{IN} < 0.5\text{ V}$ )	$R_{IN}$	–	200	–	k $\Omega$
High level input voltage threshold	$V_{IN}$	2.3	–	–	V
Logic “1” input bias current @ $V_{IN\_XX} = 5\text{ V}$ @ 25°C	$I_{IN+}$	–	5	25	$\mu\text{A}$
Logic “0” input bias current @ $V_{IN\_XX} = 0\text{ V}$ @ 25°C	$I_{IN-}$	–	–	2.0	$\mu\text{A}$

## SUPPLY SECTION

$V_{CC}$ UV Start-up voltage threshold	$V_{CC\_stup}$	8.0	8.9	9.9	V
$V_{CC}$ UV Shut-down voltage threshold	$V_{CC\_shtdwn}$	7.3	8.2	9.1	V
Hysteresis on $V_{CC}$	$V_{CC\_hyst}$	0.3	0.7	–	V
Vboot Start-up voltage threshold reference to bridge pin ( $V_{boot\_stup} = V_{boot} - V_{bridge}$ )	$V_{boot\_stup}$	8.0	8.9	9.9	V
Vboot UV Shut-down voltage threshold	$V_{boot\_shtdwn}$	7.3	8.2	9.1	V
Hysteresis on Vboot	$V_{boot\_hyst}$	0.3	0.7	–	V
Leakage current on high voltage pins to GND ( $V_{BOOT} = V_{BRIDGE} = DRV\_HI = 600\text{ V}$ )	$I_{HV\_LEAK}$	–	5	40	$\mu\text{A}$
Consumption in active mode ( $V_{CC} = V_{boot}$ , $f_{sw} = 100\text{ kHz}$ and 1 nF load on both driver outputs)	ICC1	–	4	5	mA
Consumption in inhibition mode ( $V_{CC} = V_{boot}$ )	ICC2	–	250	400	$\mu\text{A}$
$V_{CC}$ current consumption in inhibition mode	ICC3	–	200	–	$\mu\text{A}$
Vboot current consumption in inhibition mode	ICC4	–	50	–	$\mu\text{A}$

- Parameter guaranteed by design.
  - Turn-off propagation delay @  $V_{bridge} = 600\text{ V}$  is guaranteed by design.
  - See characterization curve for  $\Delta t$  parameters variation on the full range temperature.
  - Version B integrates a dead time in order to prevent any cross conduction between  $DRV\_HI$  and  $DRV\_LO$ . See timing diagram of Figure 10.
  - Timing diagram definition see: Figure 7, Figure 8 and Figure 9.
- Product parametric performance is indicated in the Electrical Characteristics for the listed test conditions, unless otherwise noted. Product performance may not be indicated by the Electrical Characteristics if operated under different conditions.

# NCP5106A, NCP5106B

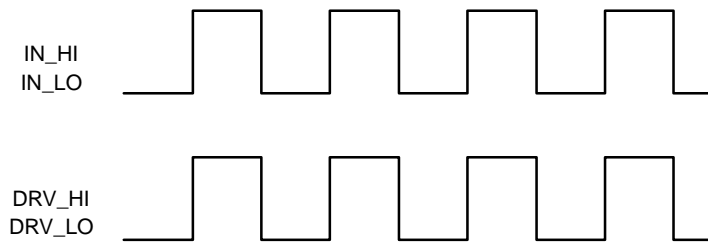

Figure 5. Input/Output Timing Diagram (A Version)

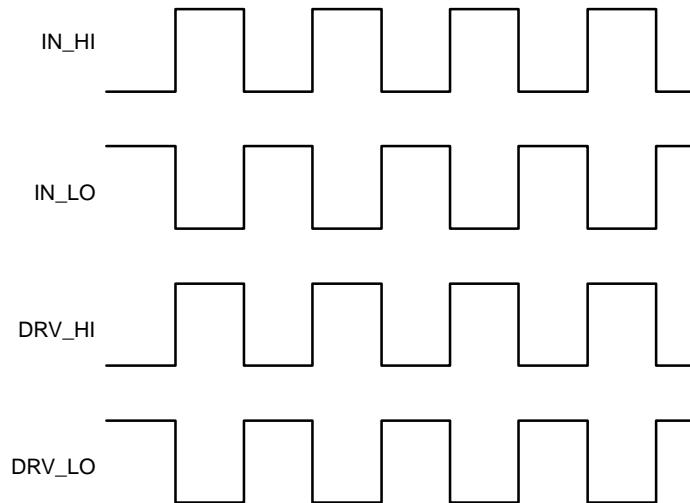

Figure 6. Input/Output Timing Diagram (B Version)

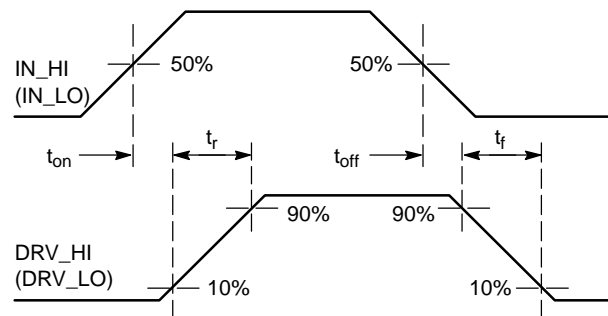
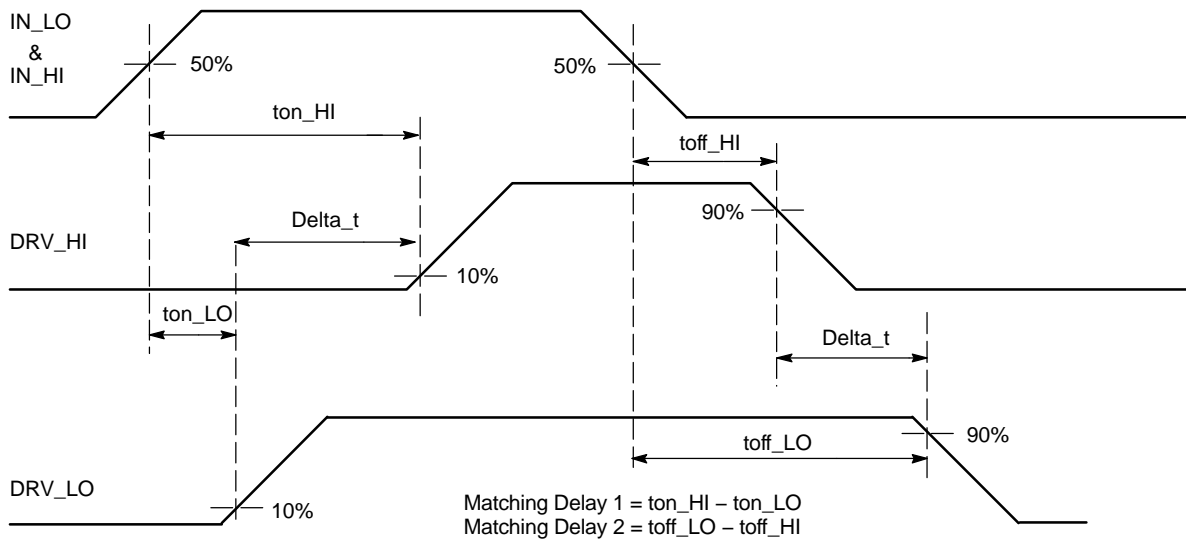
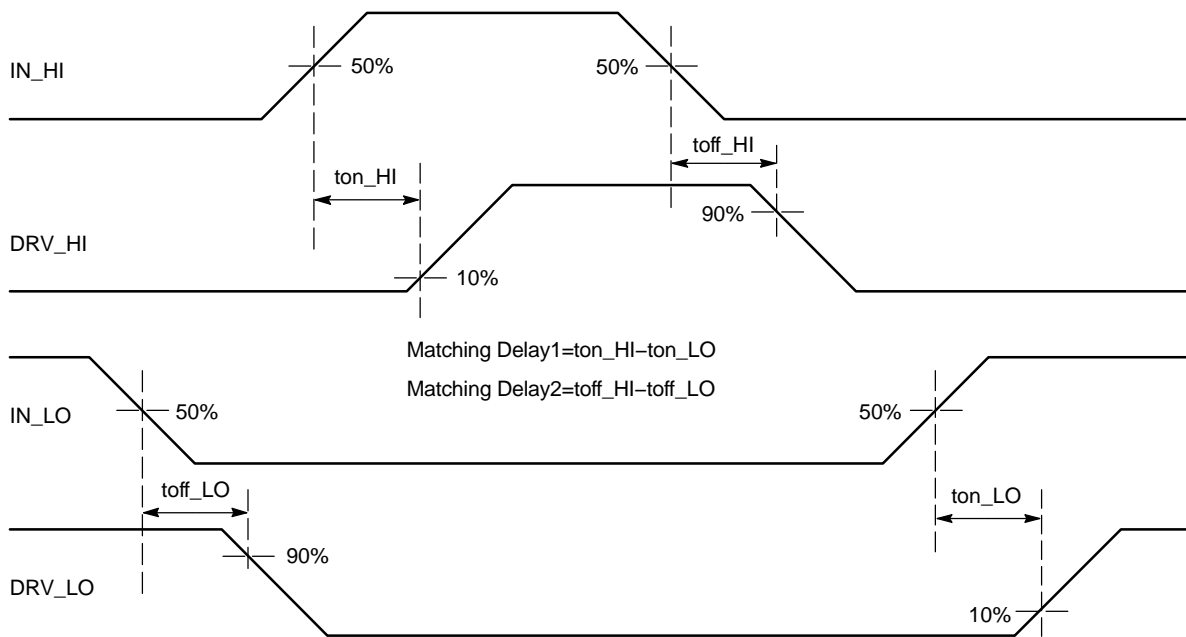

Figure 7. Propagation Delay and Rise / Fall Time Definition

# NCP5106A, NCP5106B

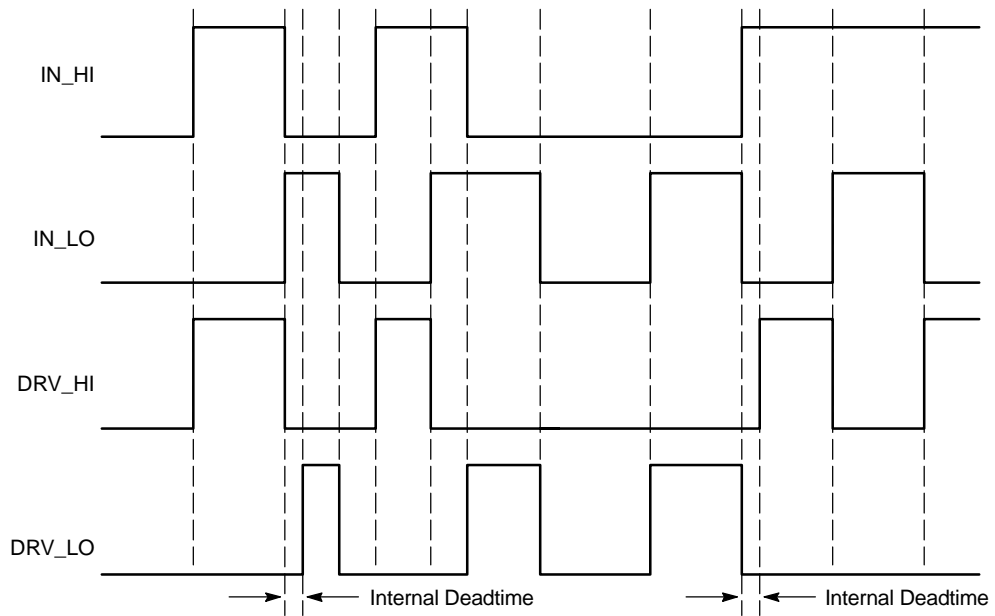

**Figure 8. Matching Propagation Delay (A Version)**



**Figure 9. Matching Propagation Delay (B Version)**

# NCP5106A, NCP5106B



**Figure 10. Input/Output Cross Conduction Output Protection Timing Diagram (B Version)**



# NCP5106A, NCP5106B

## CHARACTERIZATION CURVES

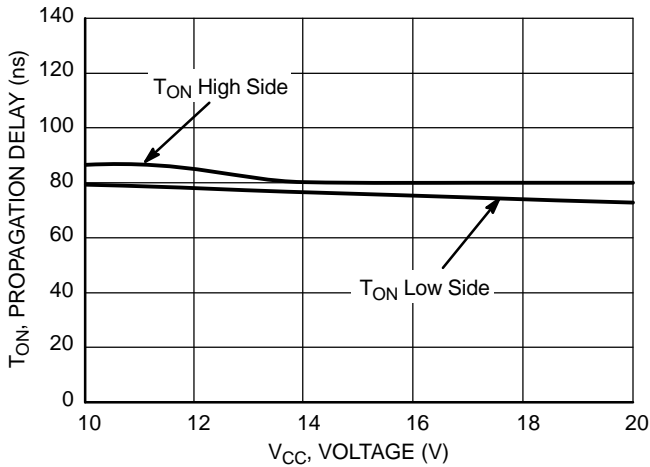

Figure 11. Turn ON Propagation Delay vs. Supply Voltage ( $V_{CC} = V_{BOOT}$ )

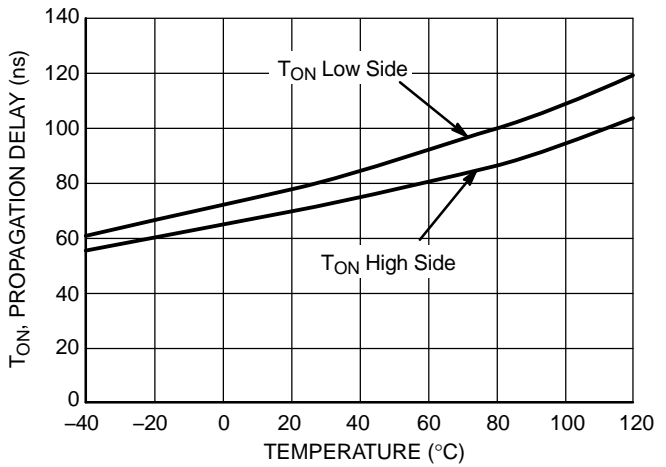

Figure 12. Turn ON Propagation Delay vs. Temperature

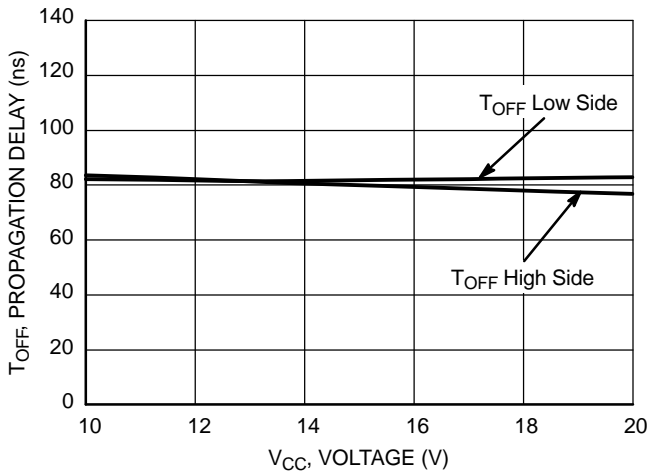

Figure 13. Turn OFF Propagation Delay vs. Supply Voltage ( $V_{CC} = V_{BOOT}$ )

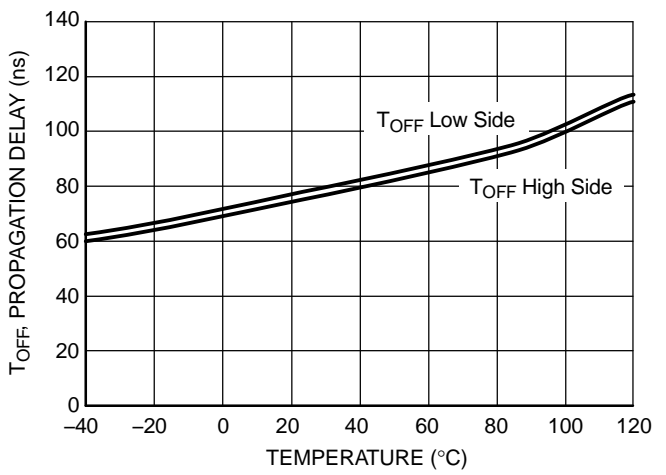

Figure 14. Turn OFF Propagation Delay vs. Temperature

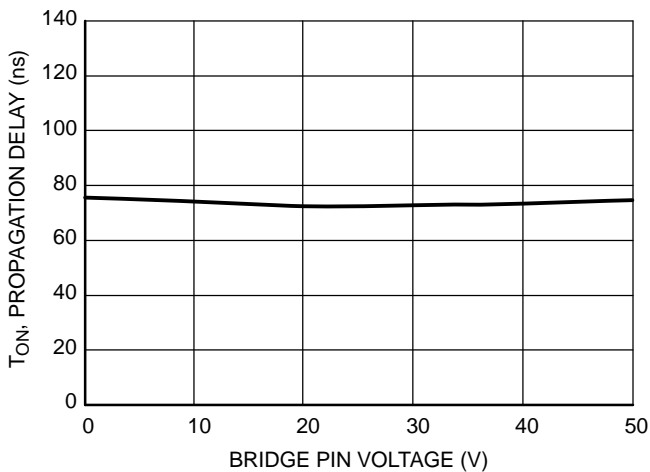

Figure 15. High Side Turn ON Propagation Delay vs.  $V_{BRIDGE}$  Voltage

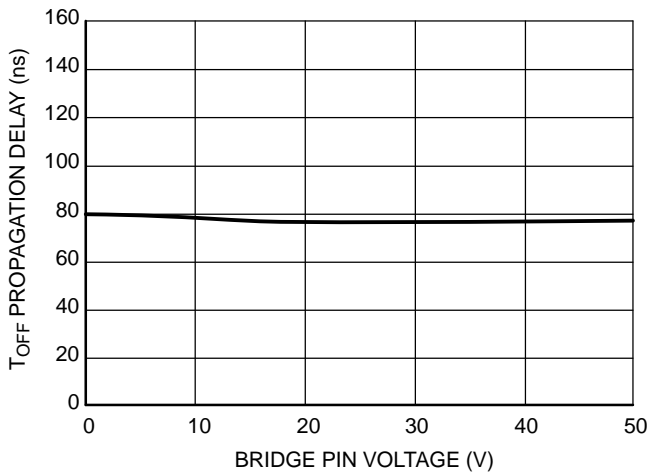
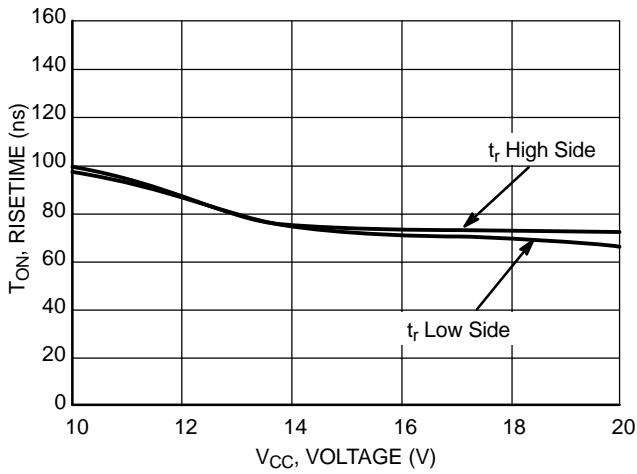

Figure 16. High Side Turn OFF Propagation Delay vs.  $V_{BRIDGE}$  Voltage

# NCP5106A, NCP5106B

## CHARACTERIZATION CURVES



**Figure 17. Turn ON Risetime vs. Supply Voltage ( $V_{CC} = V_{BOOT}$ )**

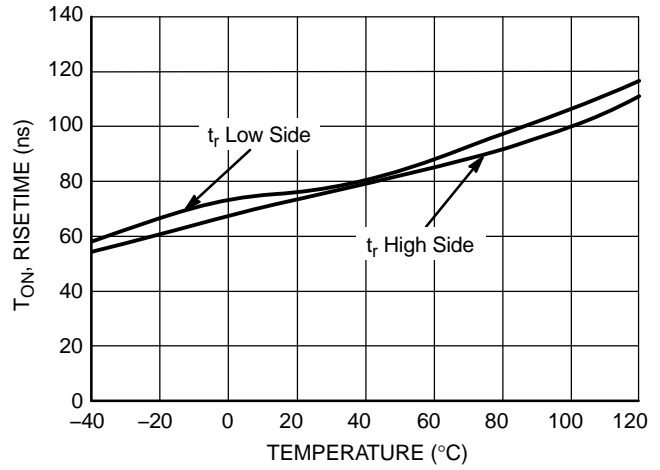

**Figure 18. Turn ON Risetime vs. Temperature**

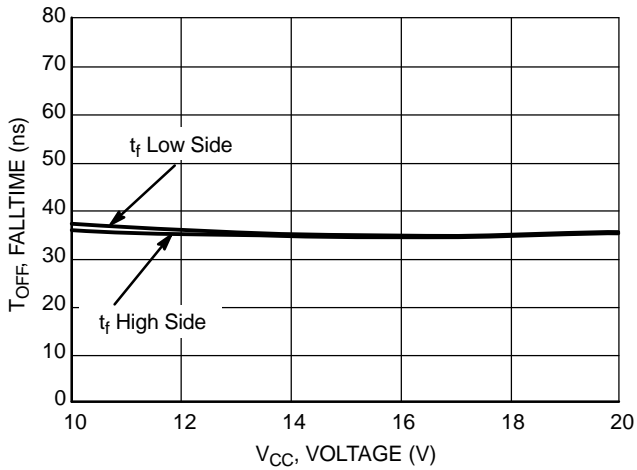

**Figure 19. Turn OFF Falltime vs. Supply Voltage ( $V_{CC} = V_{BOOT}$ )**

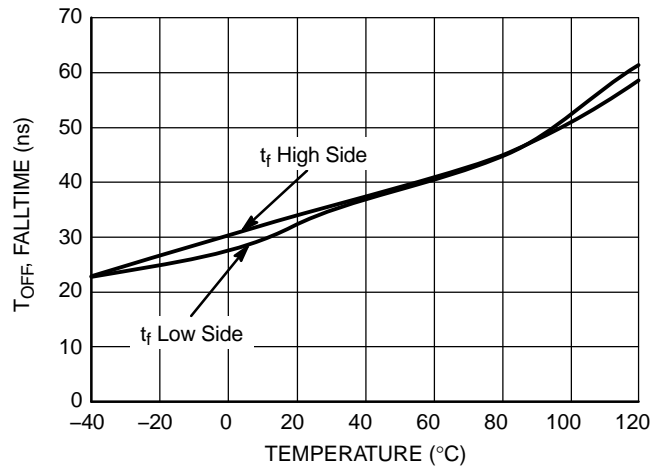

**Figure 20. Turn OFF Falltime vs. Temperature**

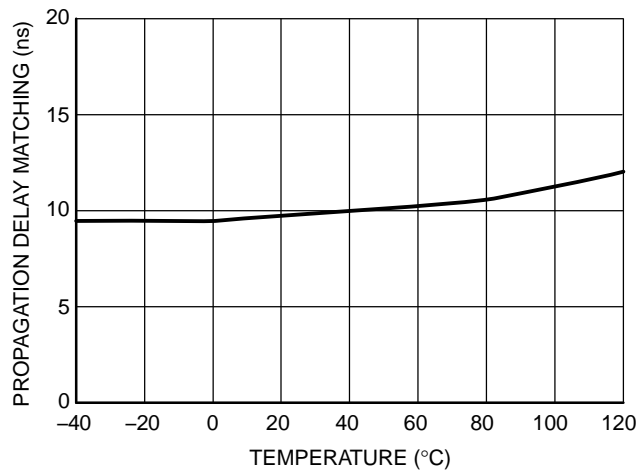

**Figure 21. Propagation Delay Matching Between High Side and Low Side Driver vs. Temperature**

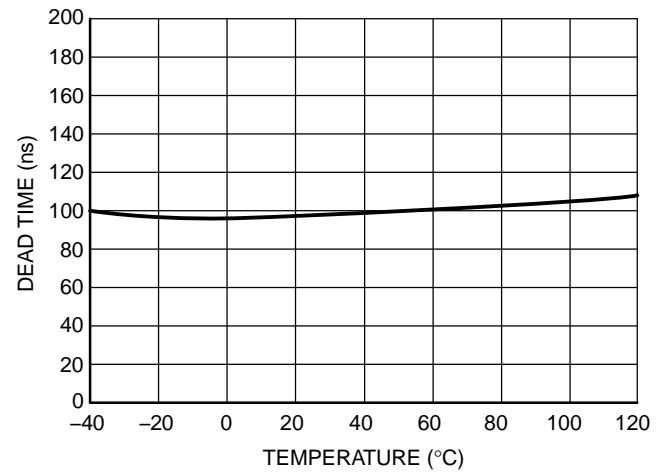

**Figure 22. Dead Time vs. Temperature**

# NCP5106A, NCP5106B

## CHARACTERIZATION CURVES

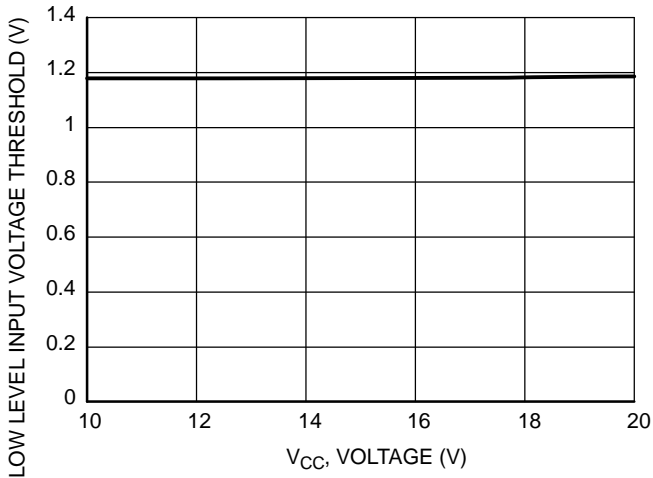

Figure 23. Low Level Input Voltage Threshold vs. Supply Voltage ( $V_{CC} = V_{BOOT}$ )

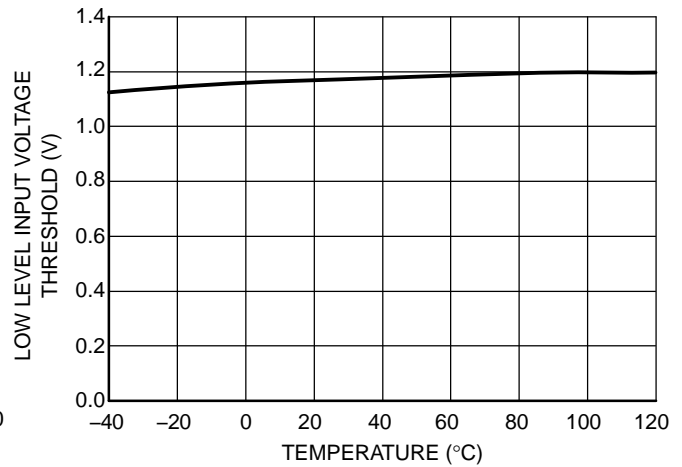

Figure 24. Low Level Input Voltage Threshold vs. Temperature

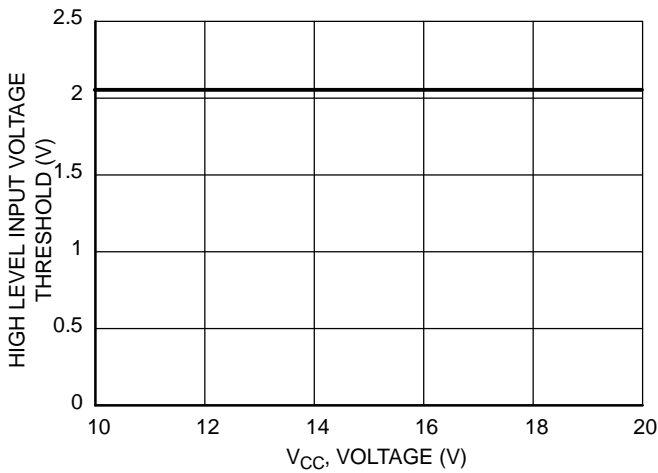

Figure 25. High Level Input Voltage Threshold vs. Supply Voltage ( $V_{CC} = V_{BOOT}$ )

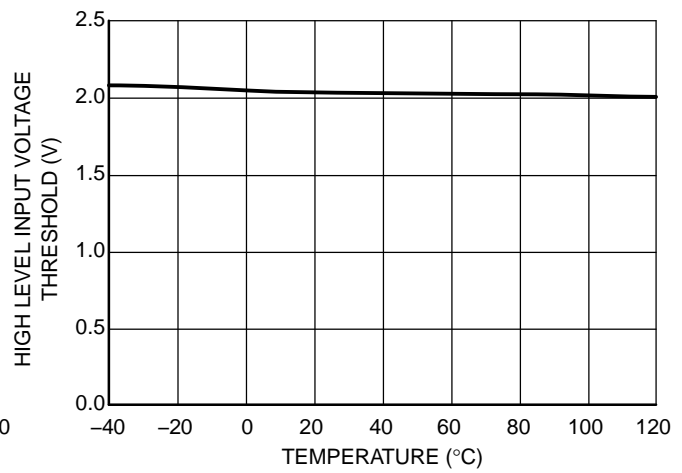

Figure 26. High Level Input Voltage Threshold vs. Temperature

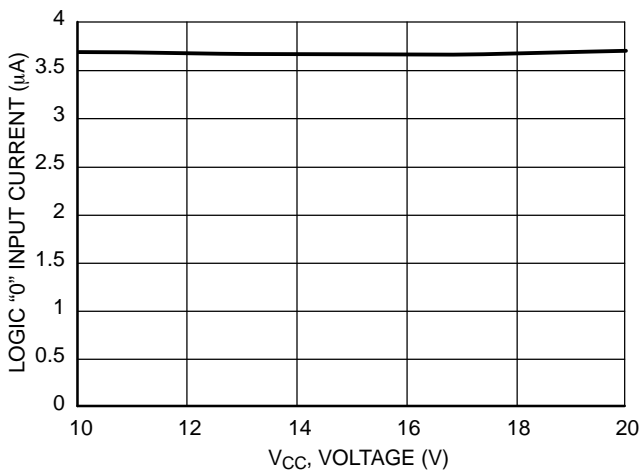

Figure 27. Logic "0" Input Current vs. Supply Voltage ( $V_{CC} = V_{BOOT}$ )

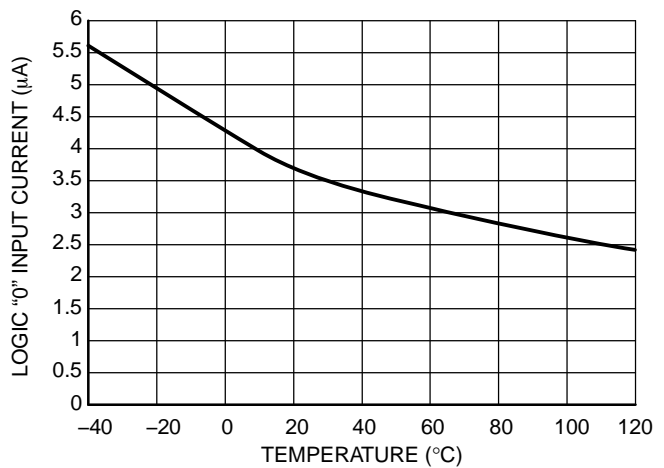

Figure 28. Logic "0" Input Current vs. Temperature

# NCP5106A, NCP5106B

## CHARACTERIZATION CURVES

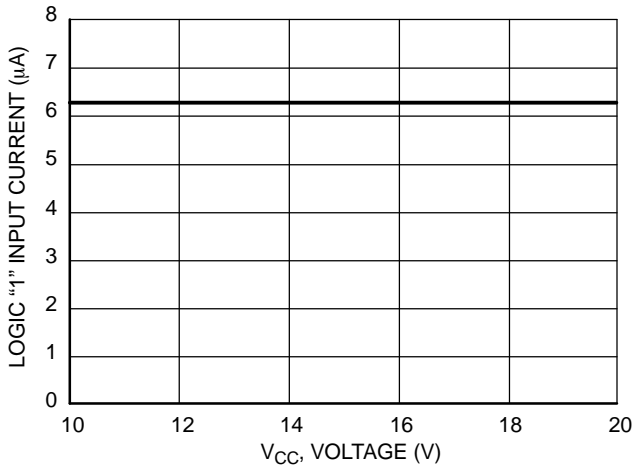

Figure 29. Logic "1" Input Current vs. Supply Voltage ( $V_{CC} = V_{BOOT}$ )

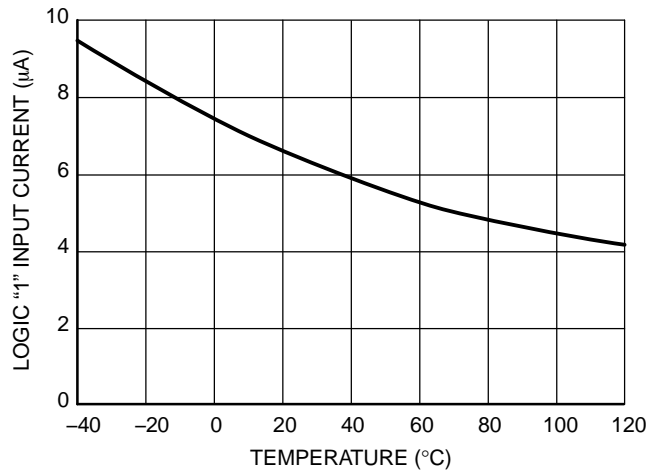

Figure 30. Logic "1" Input Current vs. Temperature

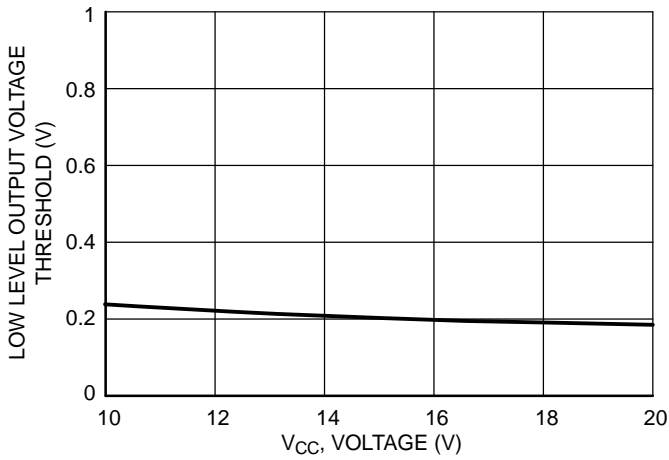

Figure 31. Low Level Output Voltage vs. Supply Voltage ( $V_{CC} = V_{BOOT}$ )

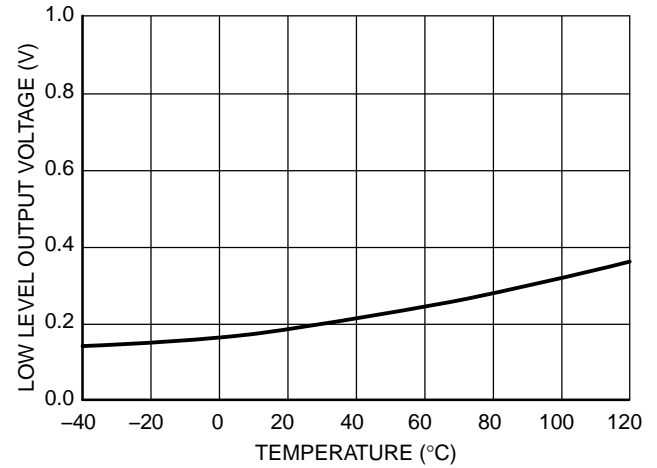

Figure 32. Low Level Output Voltage vs. Temperature

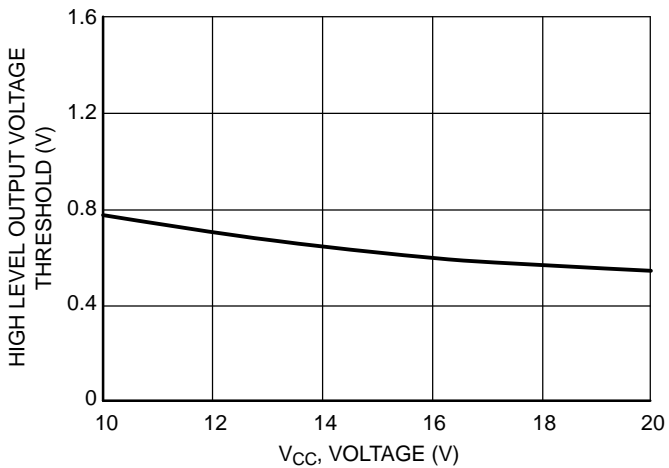

Figure 33. High Level Output Voltage vs. Supply Voltage ( $V_{CC} = V_{BOOT}$ )

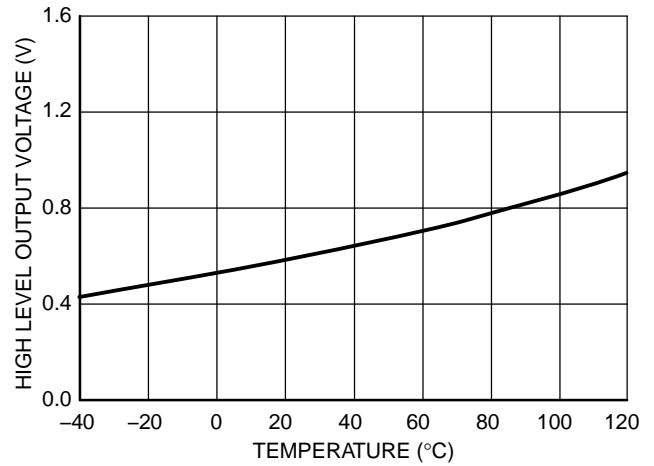

Figure 34. High Level Output Voltage vs. Temperature

# NCP5106A, NCP5106B

## CHARACTERIZATION CURVES

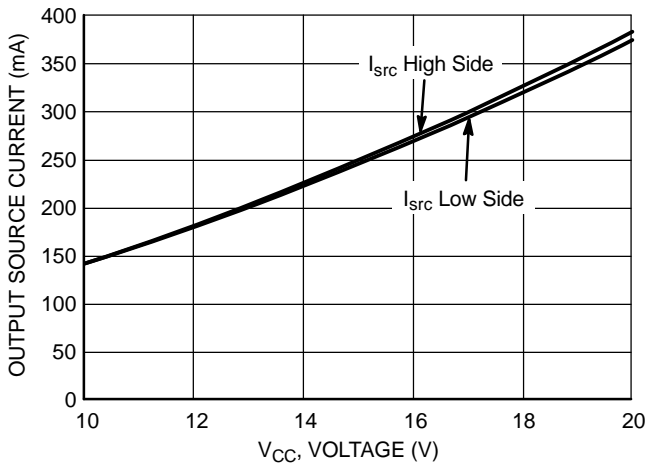

Figure 35. Output Source Current vs. Supply Voltage ( $V_{CC} = V_{BOOT}$ )

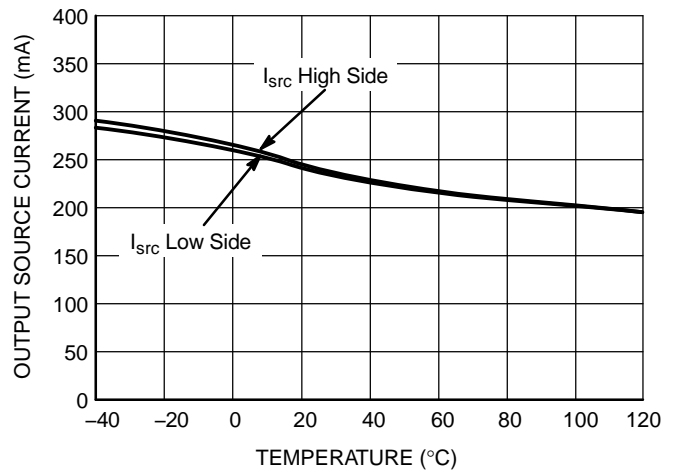

Figure 36. Output Source Current vs. Temperature

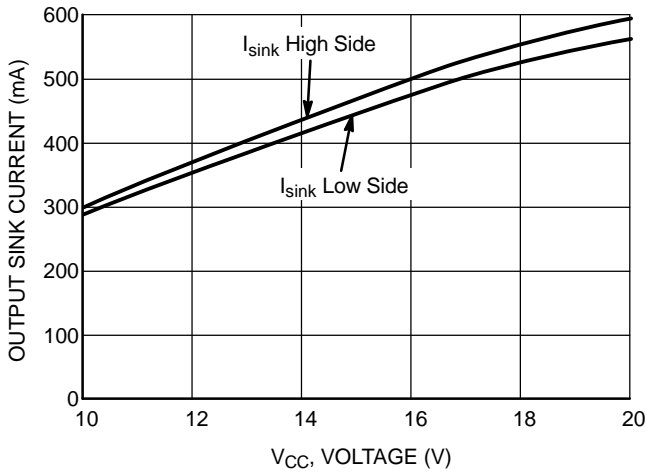

Figure 37. Output Sink Current vs. Supply Voltage ( $V_{CC} = V_{BOOT}$ )

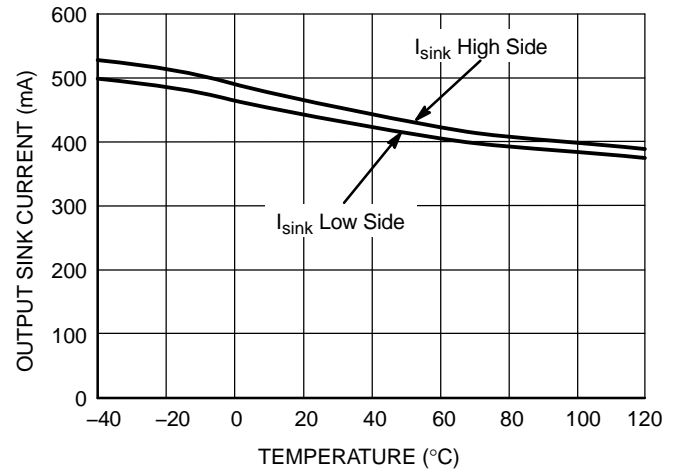

Figure 38. Output Sink Current vs. Temperature

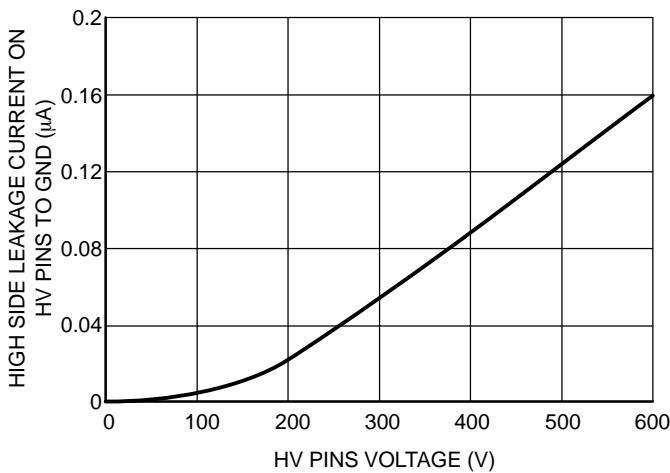

Figure 39. Leakage Current on High Voltage Pins (600 V) to Ground vs.  $V_{BRIDGE}$  Voltage ( $V_{BRIDGE} = V_{BOOT} = V_{DRV\_HI}$ )

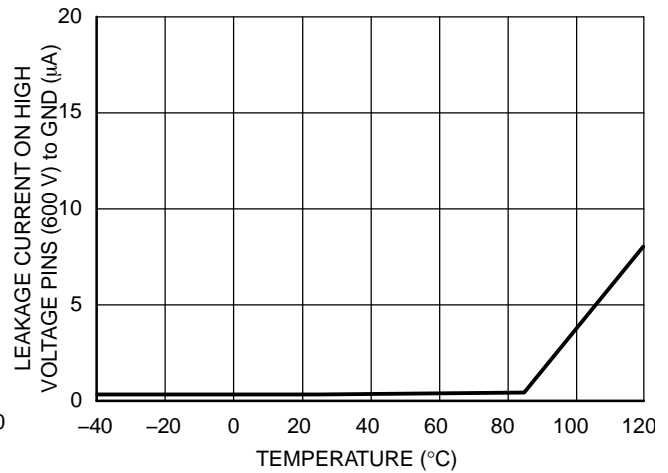

Figure 40. Leakage Current on High Voltage Pins (600 V) to Ground vs. Temperature ( $V_{BRIDGE} = V_{BOOT} = V_{DRV\_HI} = 600$  V)

# NCP5106A, NCP5106B

## CHARACTERIZATION CURVES

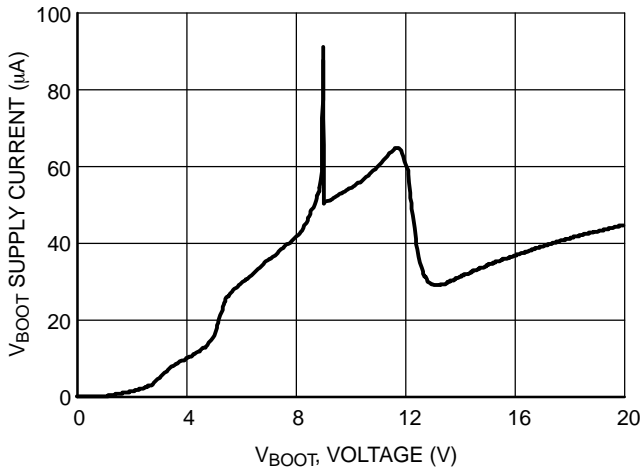

Figure 41.  $V_{BOOT}$  Supply Current vs. Bootstrap Supply Voltage

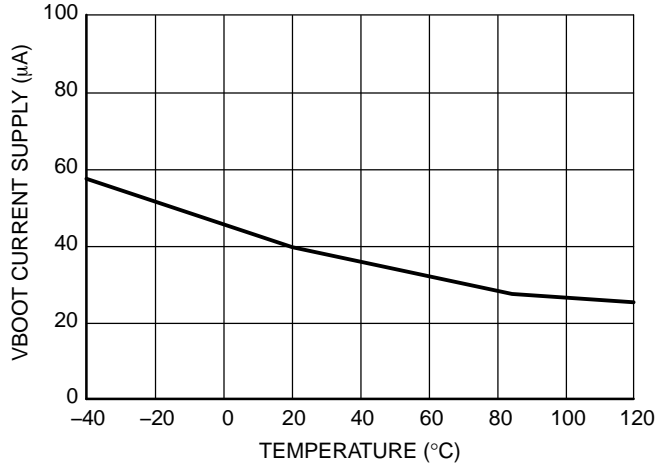

Figure 42.  $V_{BOOT}$  Supply Current vs. Temperature

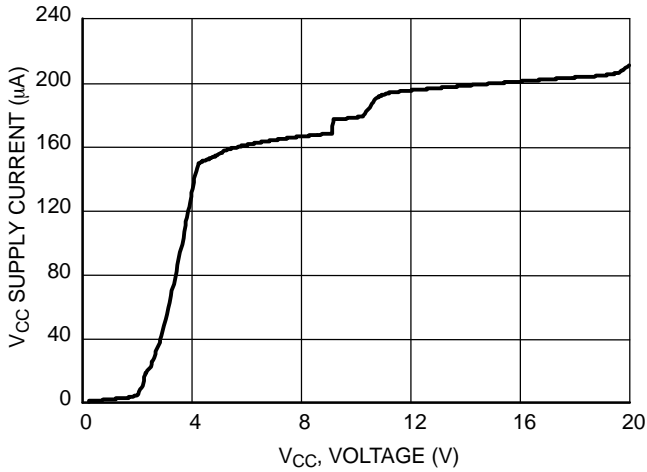

Figure 43.  $V_{CC}$  Supply Current vs.  $V_{CC}$  Supply Voltage

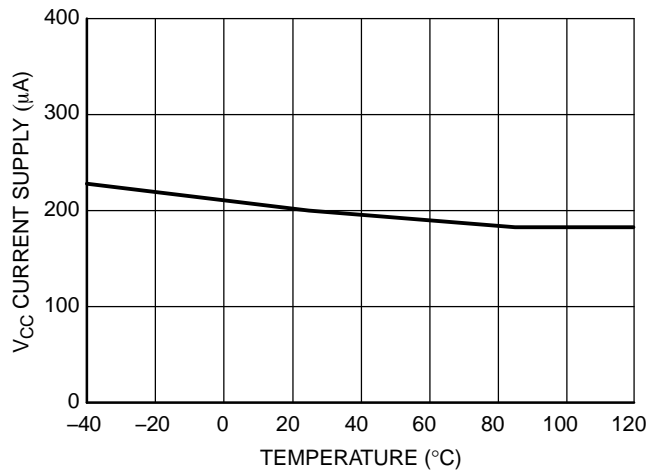

Figure 44.  $V_{CC}$  Supply Current vs. Temperature

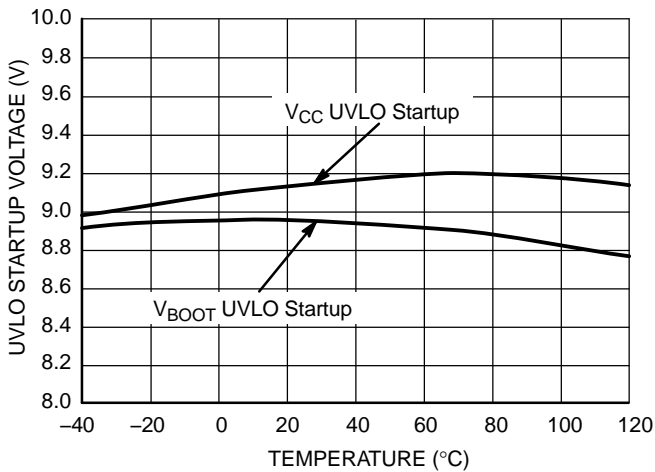

Figure 45. UVLO Startup Voltage vs. Temperature

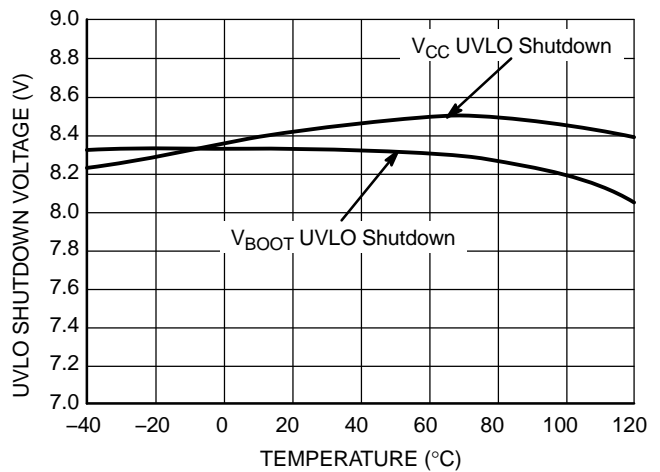
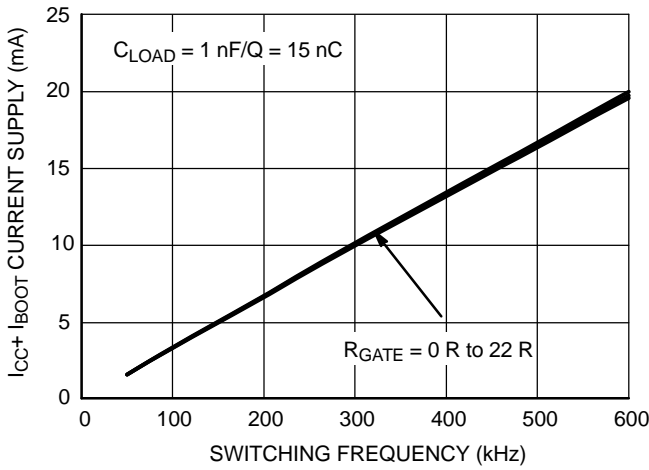

Figure 46. UVLO Shutdown Voltage vs. Temperature

# NCP5106A, NCP5106B

## CHARACTERIZATION CURVES



**Figure 47.  $I_{CC1}$  Consumption vs. Switching Frequency with 15 nC Load on Each Driver @  $V_{CC} = 15\text{ V}$**

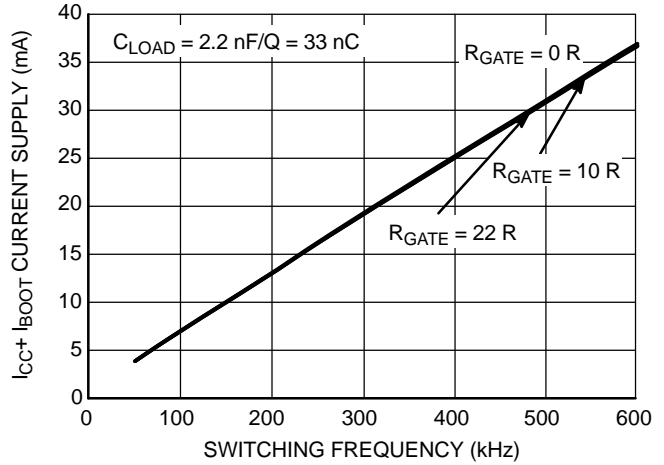

**Figure 48.  $I_{CC1}$  Consumption vs. Switching Frequency with 33 nC Load on Each Driver @  $V_{CC} = 15\text{ V}$**

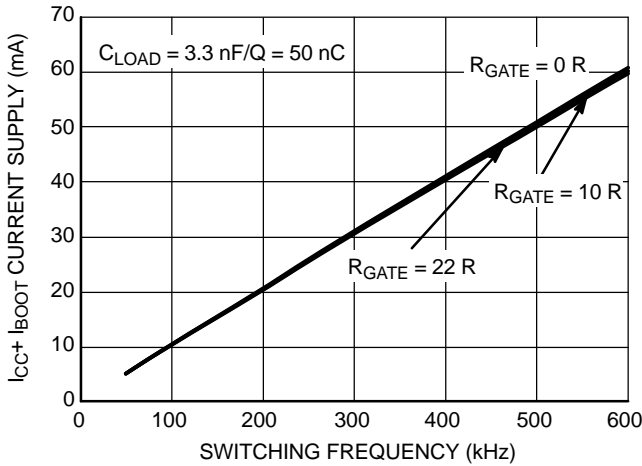

**Figure 49.  $I_{CC1}$  Consumption vs. Switching Frequency with 50 nC Load on Each Driver @  $V_{CC} = 15\text{ V}$**

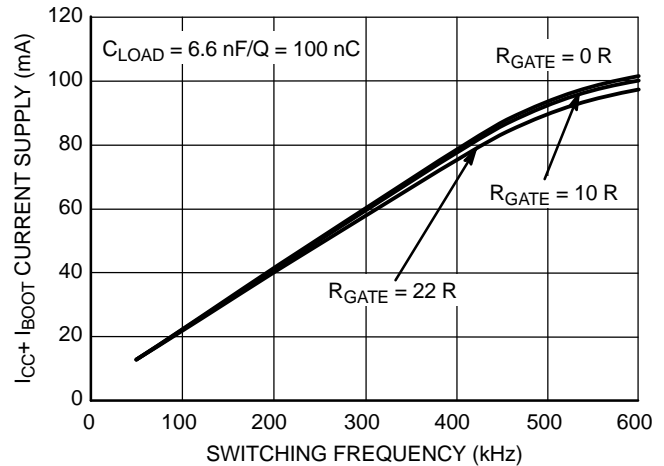

**Figure 50.  $I_{CC1}$  Consumption vs. Switching Frequency with 100 nC Load on Each Driver @  $V_{CC} = 15\text{ V}$**

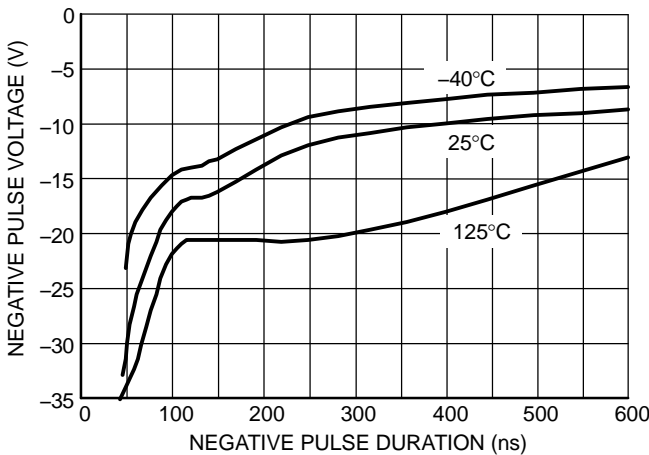

**Figure 51. NCP5106A, Negative Voltage Safe Operating Area on the Bridge Pin**

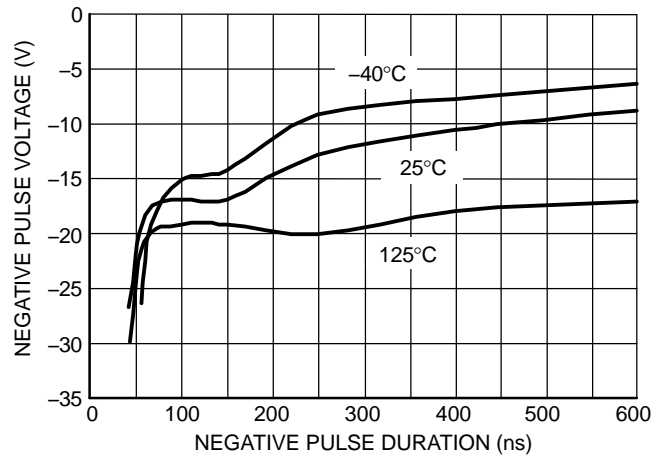

**Figure 52. NCP5106B, Negative Voltage Safe Operating Area on the Bridge Pin**

# NCP5106A, NCP5106B

## APPLICATION INFORMATION

### Negative Voltage Safe Operating Area

When the driver is used in a half bridge configuration, it is possible to see negative voltage appearing on the bridge pin (pin 6) during the power MOSFETs transitions. When the high-side MOSFET is switched off, the body diode of the low-side MOSFET starts to conduct. The negative voltage applied to the bridge pin thus corresponds to the forward voltage of the body diode. However, as pcb copper tracks and wire bonding introduce stray elements (inductance and capacitor), the maximum negative voltage of the bridge pin will combine the forward voltage and the oscillations created by the parasitic elements. As any CMOS device, the deep negative voltage of a selected pin can inject carriers into the substrate, leading to an erratic behavior of the concerned component. ON Semiconductor provides characterization data of its half-bridge driver to show the maximum negative voltage the driver can safely operate with. To prevent the negative injection, it is the designer duty to verify that the amount of negative voltage pertinent to his/her application does not exceed the characterization curve we provide, including some safety margin.

In order to estimate the maximum negative voltage accepted by the driver, this parameter has been characterized over full the temperature range of the component. A test fixture has been developed in which we purposely negatively bias the bridge pin during the freewheel period of a buck converter. When the upper gate voltage shows signs of an erratic behavior, we consider the limit has been reached.

Figure 51 (or 52), illustrates the negative voltage safe operating area. Its interpretation is as follows: assume a negative 10 V pulse featuring a 100 ns width is applied on the bridge pin, the driver will work correctly over the whole die temperature range. Should the pulse swing to -20 V, keeping the same width of 100 ns, the driver will not work properly or will be damaged for temperatures below 125°C.

Summary:

- If the negative pulse characteristic (negative voltage level & pulse width) is above the curves the driver runs in safe operating area.
- If the negative pulse characteristic (negative voltage level & pulse width) is below one or all curves the driver will NOT run in safe operating area.

Note, each curve of the Figure 51 (or 52) represents the negative voltage and width level where the driver starts to fail at the corresponding die temperature.

If in the application the bridge pin is too close of the safe operating limit, it is possible to limit the negative voltage to the bridge pin by inserting one resistor and one diode as follows:

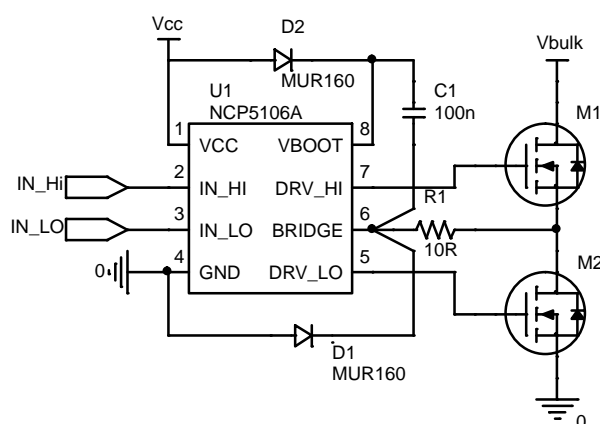

**Figure 53. R1 and D1 Improves the Robustness of the Driver**

R1 and D1 should be placed as close as possible of the driver. D1 should be connected directly between the bridge pin (pin 6) and the ground pin (pin 4). By this way the negative voltage applied to the bridge pin will be limited by D1 and R1 and will prevent any wrong behavior.

### ORDERING INFORMATION

Device	Package	Shipping†
NCP5106APG	PDIP-8 (Pb-Free)	50 Units / Rail
NCP5106ADR2G	SOIC-8 (Pb-Free)	2500 / Tape & Reel
NCP5106BPG	PDIP-8 (Pb-Free)	50 Units / Rail
NCP5106BDR2G	SOIC-8 (Pb-Free)	2500 / Tape & Reel
NCP5106AMNTWG	DFN10 (Pb-Free)	4000 / Tape & Reel
NCP5106BMNTWG	DFN10 (Pb-Free)	4000 / Tape & Reel

†For information on tape and reel specifications, including part orientation and tape sizes, please refer to our Tape and Reel Packaging Specifications Brochure, BRD8011/D.



# MECHANICAL CASE OUTLINE

## PACKAGE DIMENSIONS

ON Semiconductor®

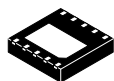

SCALE 2:1

### DFN10 4x4, 0.8P

#### CASE 506DJ

#### ISSUE 0

DATE 20 MAY 2016

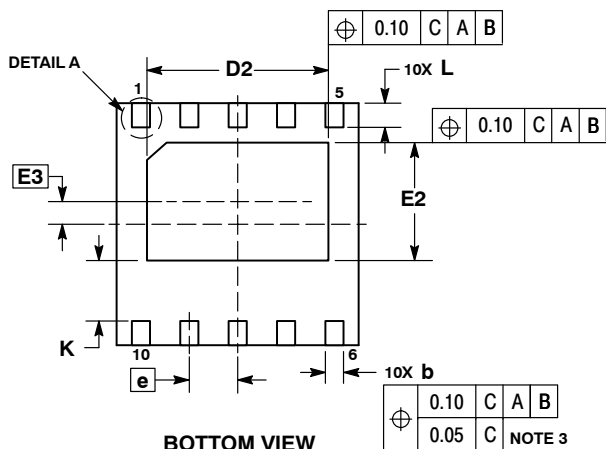
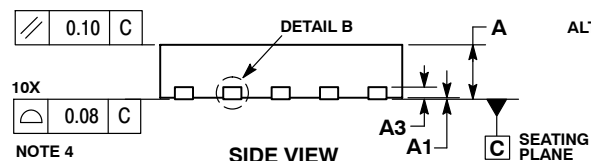
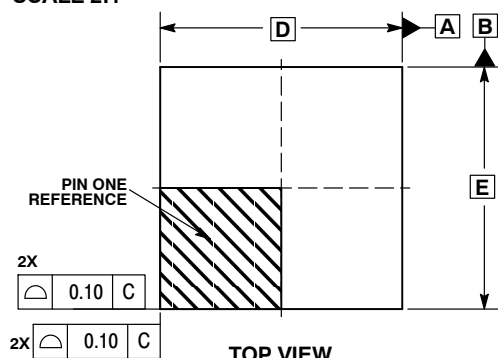

### RECOMMENDED MOUNTING FOOTPRINT

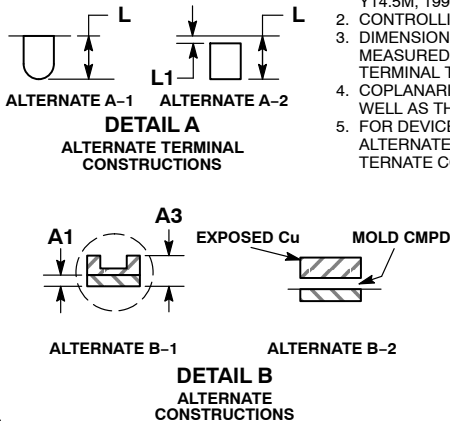
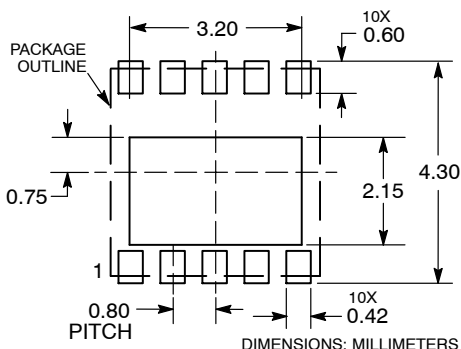

- NOTES:
1. DIMENSIONING AND TOLERANCING PER ASME Y14.5M, 1994.
  2. CONTROLLING DIMENSION: MILLIMETERS.
  3. DIMENSION b APPLIES TO PLATED TERMINAL AND IS MEASURED BETWEEN 0.25 AND 0.30 MM FROM THE TERMINAL TIP.
  4. COPLANARITY APPLIES TO THE EXPOSED PAD AS WELL AS THE TERMINALS.
  5. FOR DEVICE OPN CONTAINING W OPTION, DETAIL A ALTERNATE CONSTRUCTION A-2 AND DETAIL B ALTERNATE CONSTRUCTION B-2 ARE NOT APPLICABLE.

DIM	MILLIMETERS	
	MIN	MAX
A	0.80	1.00
A1	0.00	0.05
A3	0.20 REF	
b	0.25	0.35
D	4.00 BSC	
D2	2.90	3.10
E	4.00 BSC	
E2	1.85	2.05
E3	0.375 BSC	
e	0.80 BSC	
K	0.90	---
L	0.35	0.45
L1	0.00	0.15

### GENERIC MARKING DIAGRAM\*

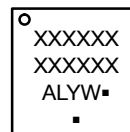

- XXXXX = Specific Device Code
- A = Assembly Location
- L = Wafer Lot
- Y = Year
- W = Work Week
- = Pb-Free Package

(Note: Microdot may be in either location)

\*This information is generic. Please refer to device data sheet for actual part marking. Pb-Free indicator, "G", may or not be present.

<b>DOCUMENT NUMBER:</b>	<b>98AON12037G</b>	Electronic versions are uncontrolled except when accessed directly from the Document Repository. Printed versions are uncontrolled except when stamped "CONTROLLED COPY" in red.
<b>DESCRIPTION:</b>	<b>DFN10 4X4, 0.8P</b>	<b>PAGE 1 OF 1</b>

ON Semiconductor and are trademarks of Semiconductor Components Industries, LLC dba ON Semiconductor or its subsidiaries in the United States and/or other countries. ON Semiconductor reserves the right to make changes without further notice to any products herein. ON Semiconductor makes no warranty, representation or guarantee regarding the suitability of its products for any particular purpose, nor does ON Semiconductor assume any liability arising out of the application or use of any product or circuit, and specifically disclaims any and all liability, including without limitation special, consequential or incidental damages. ON Semiconductor does not convey any license under its patent rights nor the rights of others.

# MECHANICAL CASE OUTLINE PACKAGE DIMENSIONS

ON Semiconductor®



SCALE 1:1

PDIP-8  
CASE 626-05  
ISSUE P

DATE 22 APR 2015



NOTES:

1. DIMENSIONING AND TOLERANCING PER ASME Y14.5M, 1994.
2. CONTROLLING DIMENSION: INCHES.
3. DIMENSIONS A, A1 AND L ARE MEASURED WITH THE PACKAGE SEATED IN JEDEC SEATING PLANE GAUGE GS-3.
4. DIMENSIONS D, D1 AND E1 DO NOT INCLUDE MOLD FLASH OR PROTRUSIONS. MOLD FLASH OR PROTRUSIONS ARE NOT TO EXCEED 0.10 INCH.
5. DIMENSION E IS MEASURED AT A POINT 0.015 BELOW DATUM PLANE H WITH THE LEADS CONSTRAINED PERPENDICULAR TO DATUM C.
6. DIMENSION eB IS MEASURED AT THE LEAD TIPS WITH THE LEADS UNCONSTRAINED.
7. DATUM PLANE H IS COINCIDENT WITH THE BOTTOM OF THE LEADS, WHERE THE LEADS EXIT THE BODY.
8. PACKAGE CONTOUR IS OPTIONAL (ROUNDED OR SQUARE CORNERS).

DIM	INCHES		MILLIMETERS	
	MIN	MAX	MIN	MAX
A	----	0.210	----	5.33
A1	0.015	----	0.38	----
A2	0.115	0.195	2.92	4.95
b	0.014	0.022	0.35	0.56
b2	0.060 TYP		1.52 TYP	
C	0.008	0.014	0.20	0.36
D	0.355	0.400	9.02	10.16
D1	0.005	----	0.13	----
E	0.300	0.325	7.62	8.26
E1	0.240	0.280	6.10	7.11
e	0.100 BSC		2.54 BSC	
eB	----	0.430	----	10.92
L	0.115	0.150	2.92	3.81
M	----	10°	----	10°

GENERIC MARKING DIAGRAM\*



- XXXX = Specific Device Code
- A = Assembly Location
- WL = Wafer Lot
- YY = Year
- WW = Work Week
- G = Pb-Free Package

\*This information is generic. Please refer to device data sheet for actual part marking. Pb-Free indicator, "G" or microdot "▪", may or may not be present.

- STYLE 1:  
PIN 1. AC IN  
2. DC + IN  
3. DC - IN  
4. AC IN  
5. GROUND  
6. OUTPUT  
7. AUXILIARY  
8. V<sub>CC</sub>

DOCUMENT NUMBER:	98ASB42420B	Electronic versions are uncontrolled except when accessed directly from the Document Repository. Printed versions are uncontrolled except when stamped "CONTROLLED COPY" in red.
DESCRIPTION:	PDIP-8	PAGE 1 OF 1

ON Semiconductor and ON are trademarks of Semiconductor Components Industries, LLC dba ON Semiconductor or its subsidiaries in the United States and/or other countries. ON Semiconductor reserves the right to make changes without further notice to any products herein. ON Semiconductor makes no warranty, representation or guarantee regarding the suitability of its products for any particular purpose, nor does ON Semiconductor assume any liability arising out of the application or use of any product or circuit, and specifically disclaims any and all liability, including without limitation special, consequential or incidental damages. ON Semiconductor does not convey any license under its patent rights nor the rights of others.

# MECHANICAL CASE OUTLINE PACKAGE DIMENSIONS



SCALE 1:1

SOIC-8 NB  
CASE 751-07  
ISSUE AK

DATE 16 FEB 2011



- NOTES:
1. DIMENSIONING AND TOLERANCING PER ANSI Y14.5M, 1982.
  2. CONTROLLING DIMENSION: MILLIMETER.
  3. DIMENSION A AND B DO NOT INCLUDE MOLD PROTRUSION.
  4. MAXIMUM MOLD PROTRUSION 0.15 (0.006) PER SIDE.
  5. DIMENSION D DOES NOT INCLUDE DAMBAR PROTRUSION. ALLOWABLE DAMBAR PROTRUSION SHALL BE 0.127 (0.005) TOTAL IN EXCESS OF THE D DIMENSION AT MAXIMUM MATERIAL CONDITION.
  6. 751-01 THRU 751-06 ARE OBSOLETE. NEW STANDARD IS 751-07.

DIM	MILLIMETERS		INCHES	
	MIN	MAX	MIN	MAX
A	4.80	5.00	0.189	0.197
B	3.80	4.00	0.150	0.157
C	1.35	1.75	0.053	0.069
D	0.33	0.51	0.013	0.020
G	1.27 BSC		0.050 BSC	
H	0.10	0.25	0.004	0.010
J	0.19	0.25	0.007	0.010
K	0.40	1.27	0.016	0.050
M	0°	8°	0°	8°
N	0.25	0.50	0.010	0.020
S	5.80	6.20	0.228	0.244

## GENERIC MARKING DIAGRAM\*

### SOLDERING FOOTPRINT\*

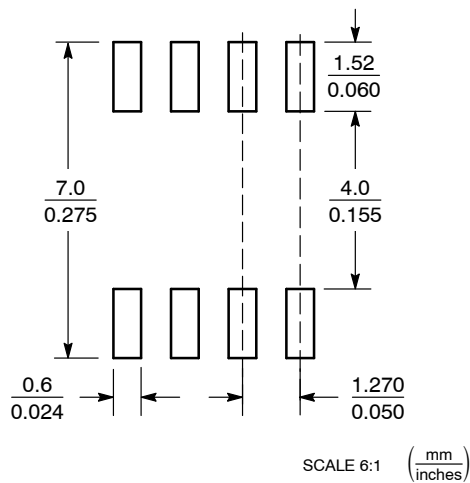

XXXXX = Specific Device Code  
A = Assembly Location  
L = Wafer Lot  
Y = Year  
W = Work Week  
▪ = Pb-Free Package

XXXXXX = Specific Device Code  
A = Assembly Location  
Y = Year  
WW = Work Week  
▪ = Pb-Free Package

\*This information is generic. Please refer to device data sheet for actual part marking. Pb-Free indicator, "G" or microdot "▪", may or may not be present. Some products may not follow the Generic Marking.

\*For additional information on our Pb-Free strategy and soldering details, please download the ON Semiconductor Soldering and Mounting Techniques Reference Manual, SOLDERRM/D.

## STYLES ON PAGE 2

DOCUMENT NUMBER:	98ASB42564B	Electronic versions are uncontrolled except when accessed directly from the Document Repository. Printed versions are uncontrolled except when stamped "CONTROLLED COPY" in red.
DESCRIPTION:	SOIC-8 NB	PAGE 1 OF 2

onsemi and ONSEMI are trademarks of Semiconductor Components Industries, LLC dba onsemi or its subsidiaries in the United States and/or other countries. onsemi reserves the right to make changes without further notice to any products herein. onsemi makes no warranty, representation or guarantee regarding the suitability of its products for any particular purpose, nor does onsemi assume any liability arising out of the application or use of any product or circuit, and specifically disclaims any and all liability, including without limitation special, consequential or incidental damages. onsemi does not convey any license under its patent rights nor the rights of others.

**SOIC-8 NB**  
**CASE 751-07**  
**ISSUE AK**

DATE 16 FEB 2011

- |  |   |   |   |
|--|---|---|---|
| <p><b>STYLE 1:</b><br/>         PIN 1. EMITTER<br/>         2. COLLECTOR<br/>         3. COLLECTOR<br/>         4. EMITTER<br/>         5. EMITTER<br/>         6. BASE<br/>         7. BASE<br/>         8. EMITTER</p>   | <p><b>STYLE 2:</b><br/>         PIN 1. COLLECTOR, DIE, #1<br/>         2. COLLECTOR, #1<br/>         3. COLLECTOR, #2<br/>         4. COLLECTOR, #2<br/>         5. BASE, #2<br/>         6. EMITTER, #2<br/>         7. BASE, #1<br/>         8. EMITTER, #1</p>               | <p><b>STYLE 3:</b><br/>         PIN 1. DRAIN, DIE #1<br/>         2. DRAIN, #1<br/>         3. DRAIN, #2<br/>         4. DRAIN, #2<br/>         5. GATE, #2<br/>         6. SOURCE, #2<br/>         7. GATE, #1<br/>         8. SOURCE, #1</p>                            | <p><b>STYLE 4:</b><br/>         PIN 1. ANODE<br/>         2. ANODE<br/>         3. ANODE<br/>         4. ANODE<br/>         5. ANODE<br/>         6. ANODE<br/>         7. ANODE<br/>         8. COMMON CATHODE</p>   |
| <p><b>STYLE 5:</b><br/>         PIN 1. DRAIN<br/>         2. DRAIN<br/>         3. DRAIN<br/>         4. DRAIN<br/>         5. GATE<br/>         6. GATE<br/>         7. SOURCE<br/>         8. SOURCE</p>   | <p><b>STYLE 6:</b><br/>         PIN 1. SOURCE<br/>         2. DRAIN<br/>         3. DRAIN<br/>         4. SOURCE<br/>         5. SOURCE<br/>         6. GATE<br/>         7. GATE<br/>         8. SOURCE</p>  | <p><b>STYLE 7:</b><br/>         PIN 1. INPUT<br/>         2. EXTERNAL BYPASS<br/>         3. THIRD STAGE SOURCE<br/>         4. GROUND<br/>         5. DRAIN<br/>         6. GATE 3<br/>         7. SECOND STAGE Vd<br/>         8. FIRST STAGE Vd</p>                    | <p><b>STYLE 8:</b><br/>         PIN 1. COLLECTOR, DIE #1<br/>         2. BASE, #1<br/>         3. BASE, #2<br/>         4. COLLECTOR, #2<br/>         5. COLLECTOR, #2<br/>         6. EMITTER, #2<br/>         7. EMITTER, #1<br/>         8. COLLECTOR, #1</p>                              |
| <p><b>STYLE 9:</b><br/>         PIN 1. EMITTER, COMMON<br/>         2. COLLECTOR, DIE #1<br/>         3. COLLECTOR, DIE #2<br/>         4. EMITTER, COMMON<br/>         5. EMITTER, COMMON<br/>         6. BASE, DIE #2<br/>         7. BASE, DIE #1<br/>         8. EMITTER, COMMON</p> | <p><b>STYLE 10:</b><br/>         PIN 1. GROUND<br/>         2. BIAS 1<br/>         3. OUTPUT<br/>         4. GROUND<br/>         5. GROUND<br/>         6. BIAS 2<br/>         7. INPUT<br/>         8. GROUND</p>  | <p><b>STYLE 11:</b><br/>         PIN 1. SOURCE 1<br/>         2. GATE 1<br/>         3. SOURCE 2<br/>         4. GATE 2<br/>         5. DRAIN 2<br/>         6. DRAIN 2<br/>         7. DRAIN 1<br/>         8. DRAIN 1</p>   | <p><b>STYLE 12:</b><br/>         PIN 1. SOURCE<br/>         2. SOURCE<br/>         3. SOURCE<br/>         4. GATE<br/>         5. DRAIN<br/>         6. DRAIN<br/>         7. DRAIN<br/>         8. DRAIN</p>   |
| <p><b>STYLE 13:</b><br/>         PIN 1. N.C.<br/>         2. SOURCE<br/>         3. SOURCE<br/>         4. GATE<br/>         5. DRAIN<br/>         6. DRAIN<br/>         7. DRAIN<br/>         8. DRAIN</p>  | <p><b>STYLE 14:</b><br/>         PIN 1. N-SOURCE<br/>         2. N-GATE<br/>         3. P-SOURCE<br/>         4. P-GATE<br/>         5. P-DRAIN<br/>         6. P-DRAIN<br/>         7. N-DRAIN<br/>         8. N-DRAIN</p>   | <p><b>STYLE 15:</b><br/>         PIN 1. ANODE 1<br/>         2. ANODE 1<br/>         3. ANODE 1<br/>         4. ANODE 1<br/>         5. CATHODE, COMMON<br/>         6. CATHODE, COMMON<br/>         7. CATHODE, COMMON<br/>         8. CATHODE, COMMON</p>               | <p><b>STYLE 16:</b><br/>         PIN 1. EMITTER, DIE #1<br/>         2. BASE, DIE #1<br/>         3. EMITTER, DIE #2<br/>         4. BASE, DIE #2<br/>         5. COLLECTOR, DIE #2<br/>         6. COLLECTOR, DIE #2<br/>         7. COLLECTOR, DIE #1<br/>         8. COLLECTOR, DIE #1</p> |
| <p><b>STYLE 17:</b><br/>         PIN 1. VCC<br/>         2. V2OUT<br/>         3. V1OUT<br/>         4. TXE<br/>         5. RXE<br/>         6. VEE<br/>         7. GND<br/>         8. ACC</p>  | <p><b>STYLE 18:</b><br/>         PIN 1. ANODE<br/>         2. ANODE<br/>         3. SOURCE<br/>         4. GATE<br/>         5. DRAIN<br/>         6. DRAIN<br/>         7. CATHODE<br/>         8. CATHODE</p>   | <p><b>STYLE 19:</b><br/>         PIN 1. SOURCE 1<br/>         2. GATE 1<br/>         3. SOURCE 2<br/>         4. GATE 2<br/>         5. DRAIN 2<br/>         6. MIRROR 2<br/>         7. DRAIN 1<br/>         8. MIRROR 1</p>   | <p><b>STYLE 20:</b><br/>         PIN 1. SOURCE (N)<br/>         2. GATE (N)<br/>         3. SOURCE (P)<br/>         4. GATE (P)<br/>         5. DRAIN<br/>         6. DRAIN<br/>         7. DRAIN<br/>         8. DRAIN</p>   |
| <p><b>STYLE 21:</b><br/>         PIN 1. CATHODE 1<br/>         2. CATHODE 2<br/>         3. CATHODE 3<br/>         4. CATHODE 4<br/>         5. CATHODE 5<br/>         6. COMMON ANODE<br/>         7. COMMON ANODE<br/>         8. CATHODE 6</p>  | <p><b>STYLE 22:</b><br/>         PIN 1. I/O LINE 1<br/>         2. COMMON CATHODE/VCC<br/>         3. COMMON CATHODE/VCC<br/>         4. I/O LINE 3<br/>         5. COMMON ANODE/GND<br/>         6. I/O LINE 4<br/>         7. I/O LINE 5<br/>         8. COMMON ANODE/GND</p> | <p><b>STYLE 23:</b><br/>         PIN 1. LINE 1 IN<br/>         2. COMMON ANODE/GND<br/>         3. COMMON ANODE/GND<br/>         4. LINE 2 IN<br/>         5. LINE 2 OUT<br/>         6. COMMON ANODE/GND<br/>         7. COMMON ANODE/GND<br/>         8. LINE 1 OUT</p> | <p><b>STYLE 24:</b><br/>         PIN 1. BASE<br/>         2. EMITTER<br/>         3. COLLECTOR/ANODE<br/>         4. COLLECTOR/ANODE<br/>         5. CATHODE<br/>         6. CATHODE<br/>         7. COLLECTOR/ANODE<br/>         8. COLLECTOR/ANODE</p>                                      |
| <p><b>STYLE 25:</b><br/>         PIN 1. VIN<br/>         2. N/C<br/>         3. REXT<br/>         4. GND<br/>         5. IOUT<br/>         6. IOUT<br/>         7. IOUT<br/>         8. IOUT</p>   | <p><b>STYLE 26:</b><br/>         PIN 1. GND<br/>         2. dv/dt<br/>         3. ENABLE<br/>         4. ILIMIT<br/>         5. SOURCE<br/>         6. SOURCE<br/>         7. SOURCE<br/>         8. VCC</p>  | <p><b>STYLE 27:</b><br/>         PIN 1. ILIMIT<br/>         2. OVLO<br/>         3. UVLO<br/>         4. INPUT+<br/>         5. SOURCE<br/>         6. SOURCE<br/>         7. SOURCE<br/>         8. DRAIN</p>  | <p><b>STYLE 28:</b><br/>         PIN 1. SW_TO_GND<br/>         2. DASIC_OFF<br/>         3. DASIC_SW_DET<br/>         4. GND<br/>         5. V_MON<br/>         6. VBULK<br/>         7. VBULK<br/>         8. VIN</p>  |
| <p><b>STYLE 29:</b><br/>         PIN 1. BASE, DIE #1<br/>         2. EMITTER, #1<br/>         3. BASE, #2<br/>         4. EMITTER, #2<br/>         5. COLLECTOR, #2<br/>         6. COLLECTOR, #2<br/>         7. COLLECTOR, #1<br/>         8. COLLECTOR, #1</p>                        | <p><b>STYLE 30:</b><br/>         PIN 1. DRAIN 1<br/>         2. DRAIN 1<br/>         3. GATE 2<br/>         4. SOURCE 2<br/>         5. SOURCE 1/DRAIN 2<br/>         6. SOURCE 1/DRAIN 2<br/>         7. SOURCE 1/DRAIN 2<br/>         8. GATE 1</p>                           |   |   |

<b>DOCUMENT NUMBER:</b>	<b>98ASB42564B</b>	Electronic versions are uncontrolled except when accessed directly from the Document Repository. Printed versions are uncontrolled except when stamped "CONTROLLED COPY" in red.
<b>DESCRIPTION:</b>	<b>SOIC-8 NB</b>	<b>PAGE 2 OF 2</b>

**onsemi** and **ONSEMI** are trademarks of Semiconductor Components Industries, LLC dba **onsemi** or its subsidiaries in the United States and/or other countries. **onsemi** reserves the right to make changes without further notice to any products herein. **onsemi** makes no warranty, representation or guarantee regarding the suitability of its products for any particular purpose, nor does **onsemi** assume any liability arising out of the application or use of any product or circuit, and specifically disclaims any and all liability, including without limitation special, consequential or incidental damages. **onsemi** does not convey any license under its patent rights nor the rights of others.

**onsemi**, **Onsemi**, and other names, marks, and brands are registered and/or common law trademarks of Semiconductor Components Industries, LLC dba "**onsemi**" or its affiliates and/or subsidiaries in the United States and/or other countries. **onsemi** owns the rights to a number of patents, trademarks, copyrights, trade secrets, and other intellectual property. A listing of **onsemi**'s product/patent coverage may be accessed at [www.onsemi.com/site/pdf/Patent-Marking.pdf](http://www.onsemi.com/site/pdf/Patent-Marking.pdf). **onsemi** reserves the right to make changes at any time to any products or information herein, without notice. The information herein is provided "as-is" and **onsemi** makes no warranty, representation or guarantee regarding the accuracy of the information, product features, availability, functionality, or suitability of its products for any particular purpose, nor does **onsemi** assume any liability arising out of the application or use of any product or circuit, and specifically disclaims any and all liability, including without limitation special, consequential or incidental damages. Buyer is responsible for its products and applications using **onsemi** products, including compliance with all laws, regulations and safety requirements or standards, regardless of any support or applications information provided by **onsemi**. "Typical" parameters which may be provided in **onsemi** data sheets and/or specifications can and do vary in different applications and actual performance may vary over time. All operating parameters, including "Typicals" must be validated for each customer application by customer's technical experts. **onsemi** does not convey any license under any of its intellectual property rights nor the rights of others. **onsemi** products are not designed, intended, or authorized for use as a critical component in life support systems or any FDA Class 3 medical devices or medical devices with a same or similar classification in a foreign jurisdiction or any devices intended for implantation in the human body. Should Buyer purchase or use **onsemi** products for any such unintended or unauthorized application, Buyer shall indemnify and hold **onsemi** and its officers, employees, subsidiaries, affiliates, and distributors harmless against all claims, costs, damages, and expenses, and reasonable attorney fees arising out of, directly or indirectly, any claim of personal injury or death associated with such unintended or unauthorized use, even if such claim alleges that **onsemi** was negligent regarding the design or manufacture of the part. **onsemi** is an Equal Opportunity/Affirmative Action Employer. This literature is subject to all applicable copyright laws and is not for resale in any manner.

## ADDITIONAL INFORMATION

### TECHNICAL PUBLICATIONS:

Technical Library: [www.onsemi.com/design/resources/technical-documentation](http://www.onsemi.com/design/resources/technical-documentation)  
onsemi Website: [www.onsemi.com](http://www.onsemi.com)

### ONLINE SUPPORT: [www.onsemi.com/support](http://www.onsemi.com/support)

For additional information, please contact your local Sales Representative at [www.onsemi.com/support/sales](http://www.onsemi.com/support/sales)