

Features

- Industry-Standard Pin-Out
- 4.5-V to 23-V Single-Supply Range
- Single Channel 5-A Peak Source and Sink-Drive Current
- TTL and CMOS Compatible Threshold
- Outputs Held Low During VDD-UVLO or Input Floating
- Low Propagation Delay (13-ns Typical)
- Fast Rise and Fall Times (7-ns and 6-ns Typical)
- ESD Protection Exceeds JESD 22 – 6-kV HBM, 1.5-kV CDM
- Available in SOT23-5 Package

Applications

- Switched-Mode Power Supplies
- DC-DC Converters
- Motor Control, Solar Inverters, UPS
- Gate & IGBT Drive

Description

The TPM27517 is a single-channel low-side gate-driver for MOSFET, IGBT and GaN power switches.

High sourcing and sinking current capability of 5-A allows improving switching efficiencies by minimizing slew time and switching loss. The device supports maximum 25-V supply voltage and -5 V input voltage. It improves system robustness especially in noisy industrial applications. Ultra-low propagation delay allows applications with tight timing requirements.

A small SOT23-5 package assists design for high density power supply.

Application Diagram

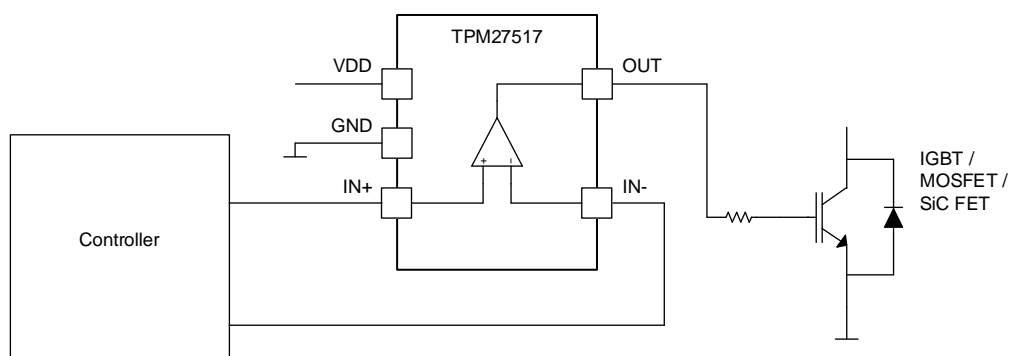

Table of Contents

Features	1
Applications	1
Description	1
Application Diagram	1
Revision History	3
Pin Configuration and Functions	4
Pin Functions	4
Specifications	5
Absolute Maximum Ratings	5
ESD, Electrostatic Discharge Protection	5
Recommended Operating Conditions	5
Thermal Information	5
Electrical Characteristics	6
Typical Performance Characteristics	7
Detailed Description	10
Overview	10
Functional Block Diagram	10
Feature Description	11
Package Outline Dimensions	12
SOT23-5	12
Order Information	13
IMPORTANT NOTICE AND DISCLAIMER	14

Revision History

Date	Revision	Notes
2021-09-08	Rev.A.0	First release version

Pin Configuration and Functions

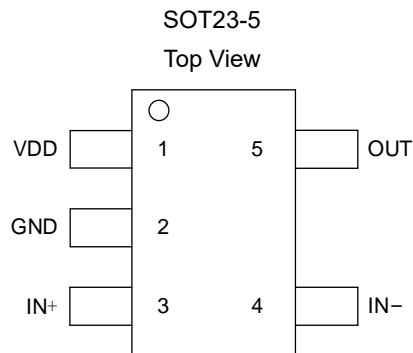

Pin Functions

Pin		I/O	Description
No.	Name		
2	GND	Ground	Device Ground
3	IN+	Input	Logic Non-inverting Input.
4	IN-	Input	Logic Inverting Input.
5	OUT	Output	Channel Output
1	VDD	Power	Power Supply Input

Specifications

Absolute Maximum Ratings

Parameter		Min	Max	Unit
V _{DD}	Power Supply Voltage	-0.3	25	V
OUT	Output Voltage Range	-0.3	V _{DD} + 0.3	V
	Output Voltage Range (200-ns pulse)	-2	V _{DD} + 0.3	V
IN+, IN-	Input Voltage Range	-5	20	V
	Continuous Output Channel Current OUT	-300	300	mA
	Pulsed Output Channel Current OUT (500 ns)	-5	5	A
T _J	Operating Junction Temperature Range	-40	150	°C
T _{STG}	Storage Temperature Range	-65	150	°C
T _L	Lead Temperature (Soldering 10 sec)		260	°C

(1) Stresses beyond those listed under Absolute Maximum Ratings may cause permanent damage to the device. Exposure to any Absolute Maximum Rating condition for extended periods may affect device reliability and lifetime.

(2) The inputs are protected by ESD protection diodes to each power supply. If the input extends more than 300 mV beyond the power supply, the input current should be limited to less than 10 mA.

(3) Power dissipation and thermal limits must be observed.

ESD, Electrostatic Discharge Protection

Symbol	Parameter	Condition	Minimum Level	Unit
HBM	Human Body Model ESD	ANSI/ESDA/JEDEC JS-001 ⁽¹⁾	±6	kV
CDM	Charged Device Model ESD	ANSI/ESDA/JEDEC JS-002 ⁽²⁾	±1.5	kV

(1) JEDEC document JEP155 states that 500-V HBM allows safe manufacturing with a standard ESD control process.

(2) JEDEC document JEP157 states that 250-V CDM allows safe manufacturing with a standard ESD control process.

Recommended Operating Conditions

Parameter	Min	Typ	Max	Unit
Power Supply Voltage, V _{DD}	4.5		23	V
Input Voltage Range IN+, IN-	0		20	V
Operating Ambient Temperature Range	-40		125	°C

Thermal Information

Package Type	θ _{JA}	θ _{JC}	Unit
SOT23-5	89.1	52.0	°C/W

Electrical Characteristics

All test condition is $V_{DD} = 12\text{ V}$, $T_J = -40^\circ\text{C} - 150^\circ\text{C}$, 1- μF capacitor between V_{DD} and GND, unless otherwise noted.

Symbol	Parameter	Conditions	Min	Typ	Max	Unit
$I_{DD(\text{off})}$	Start-up current,	$V_{DD} = 3.4\text{ V}$, $IN+ = H$, $IN- = L$		40	100	μA
		$V_{DD} = 3.4\text{ V}$, $IN+ = L$, $IN- = H$		40	100	
V_{ON}	Supply Under Voltage Lock Out rising threshold	$T_J = 25^\circ\text{C}$	3.91	4.2	4.5	V
		$T_J = -40^\circ\text{C} - 150^\circ\text{C}$	3.7	4.2	4.65	
V_{OFF}	Supply Under Voltage Lock Out falling threshold	$T_J = -40^\circ\text{C} - 150^\circ\text{C}$	3.4	3.9	4.4	V
V_{DD_H}	Supply Under Voltage Lock Out hysteresis		0.2	0.3	0.5	V
V_{IN_H}	IN- high threshold	IN- high threshold		1.9	2.3	V
V_{IN_L}	IN- low threshold	IN- low threshold	1	1.2		V
V_{IN_HYS}	IN- hysteresis		0.7	0.9	1.1	V
V_{IN+_H}	IN+ signal high threshold	IN+ high threshold		2.1	2.3	V
V_{IN+_L}	IN+ signal low threshold	IN+ low threshold	1	1.2		V
V_{IN+_HYS}	IN+ hysteresis		0.7	0.9	1.1	V
I_{OUT}	Output peak current	$C_{LOAD} = 0.22\ \mu\text{F}$, $F_{SW} = 1\ \text{kHz}$		± 5		A
$V_{DD} - V_{OH}$	Output high voltage	$I_{OUT} = -10\ \text{mA}$			40	mV
V_{OL}	Output low voltage	$I_{OUT} = 10\ \text{mA}$			10	mV
R_{OH}	Output pull-up Resistance, PMOS pull-up only	$I_{OUT} = -10\ \text{mA}$	1	1.6	3	Ω
R_{OL}	Output pull-down Resistance	$I_{OUT} = 10\ \text{mA}$	0.15	0.5	1	Ω
t_R	Output rise-time	$C_{LOAD} = 1.8\ \text{nF}$		7	18	ns
t_F	Output fall-time	$C_{LOAD} = 1.8\ \text{nF}$		6	10	ns
t_{PW}	Minimal pulse width			15	25	ns
t_{D1}	IN+ to output propagation delay	$C_{LOAD} = 1.8\ \text{nF}$, 5-V IN+ pulse	6	13	23	ns
t_{D2}	IN+ to output propagation delay	$C_{LOAD} = 1.8\ \text{nF}$, 5-V IN+ pulse	6	13	23	ns
t_{D3}	IN- to output propagation delay	$C_{LOAD} = 1.8\ \text{nF}$, 5-V IN- pulse	6	13	23	ns
t_{D4}	IN- to output propagation delay	$C_{LOAD} = 1.8\ \text{nF}$, 5-V IN- pulse	6	13	23	ns

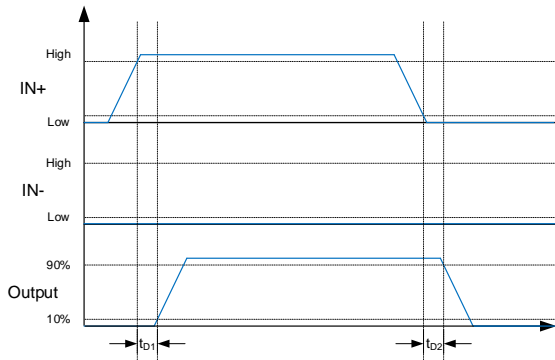

Figure 1 IN+ Timing Diagram

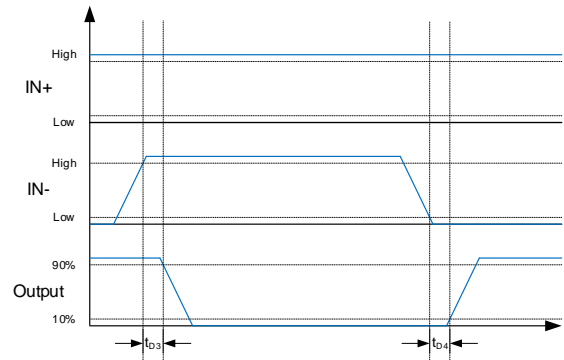
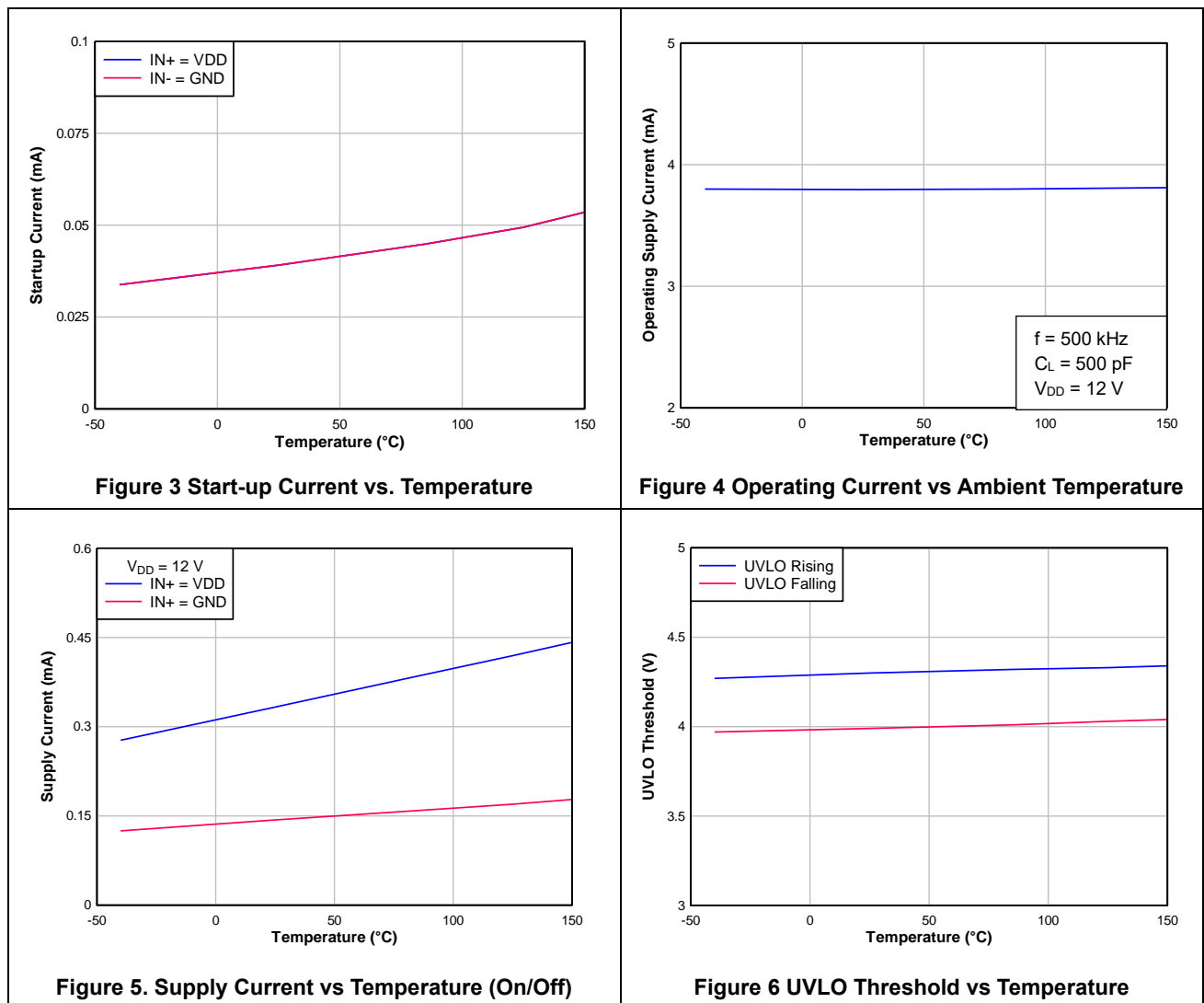

Figure 2 IN- Timing Diagram

Typical Performance Characteristics



Typical Performance Characteristics (Continued)

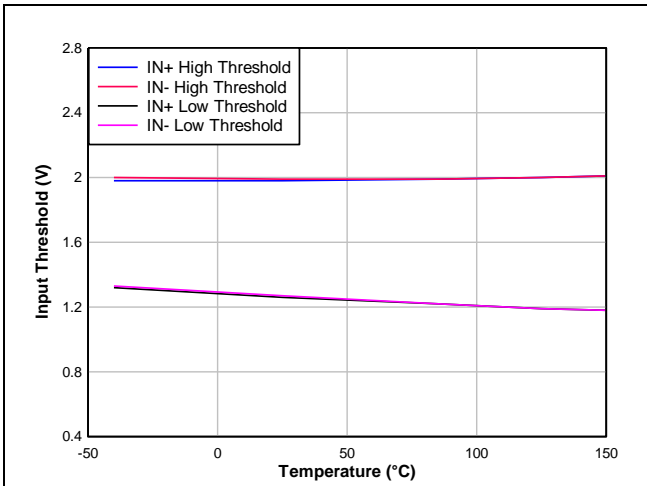

Figure 7 Input Threshold vs Temperature

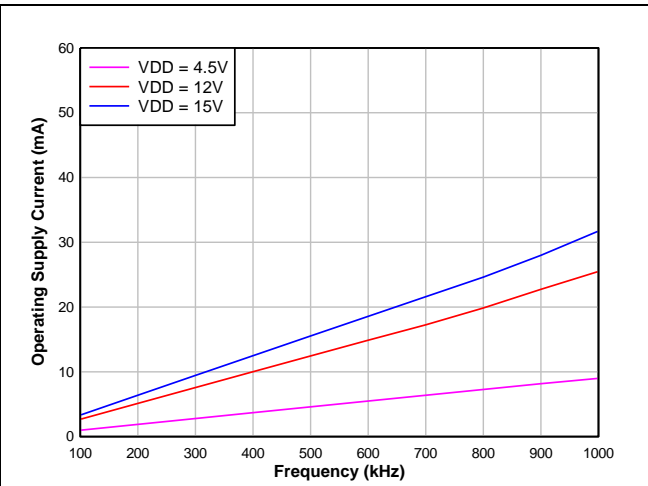

Figure 8 Operating Supply Current vs Frequency

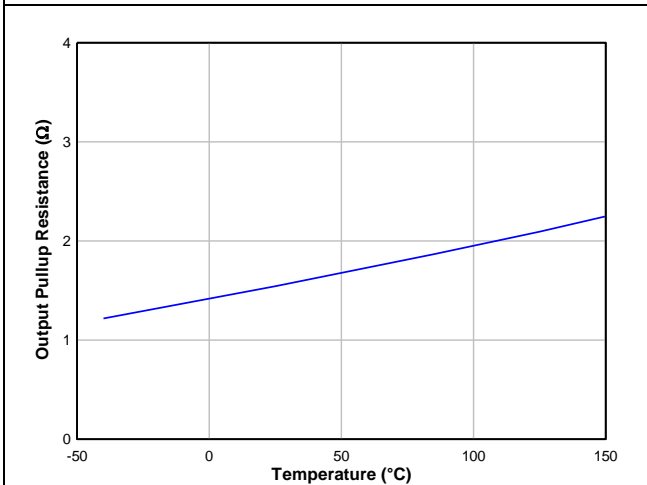

Figure 9 Output Pull-up Resistance vs Temperature

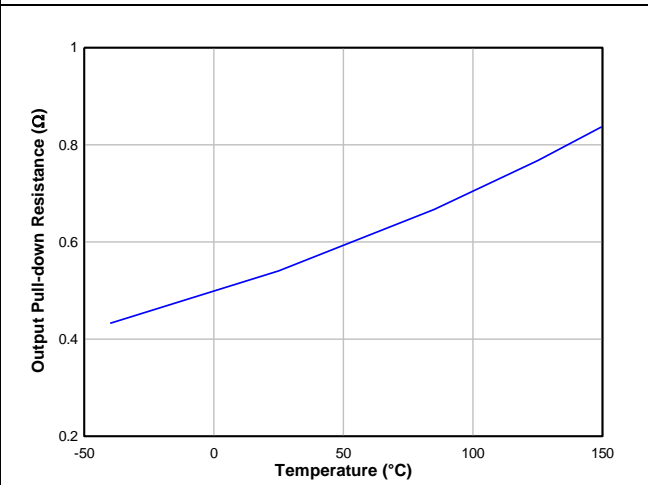

Figure 10. Output Pull-down Resistance vs Temperature

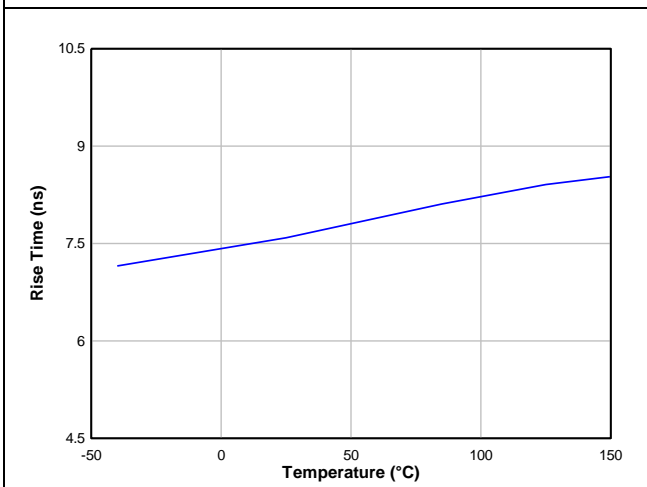

Figure 11 Rise-time vs Temperature

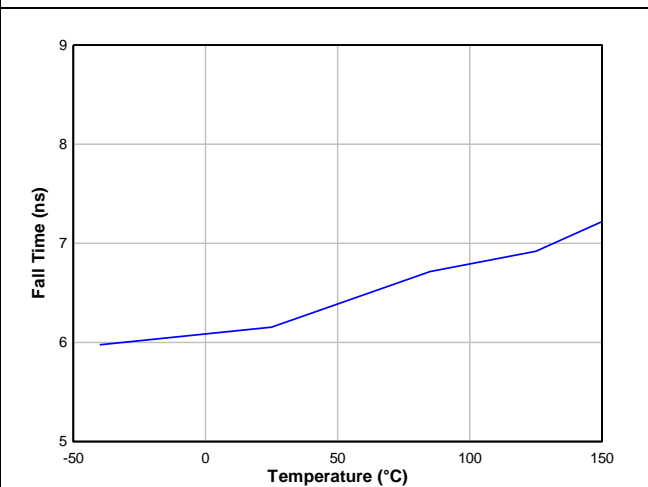

Figure 12. Fall-time vs Temperature

Typical Performance Characteristics (Continued)

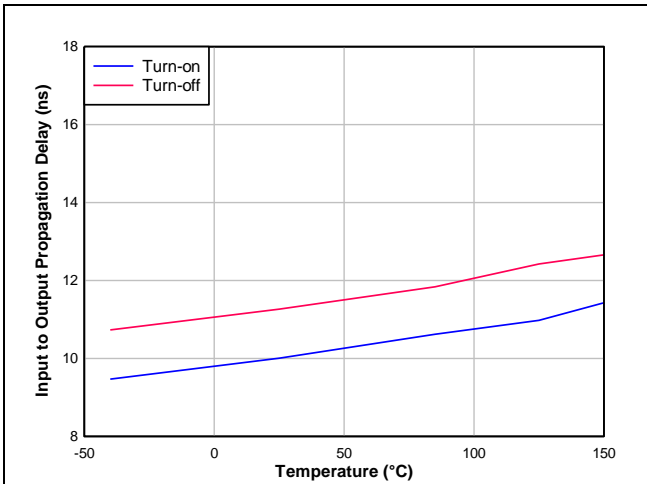

Figure 13 Input to Output Propagation Delay vs Temperature

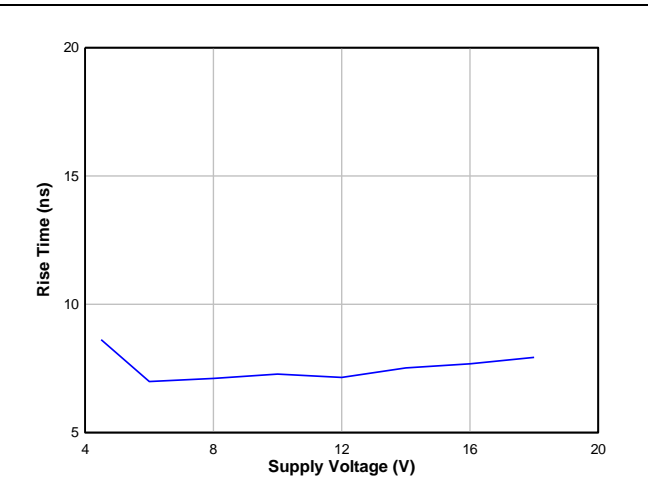

Figure 14 Rise-time vs Supply Voltage

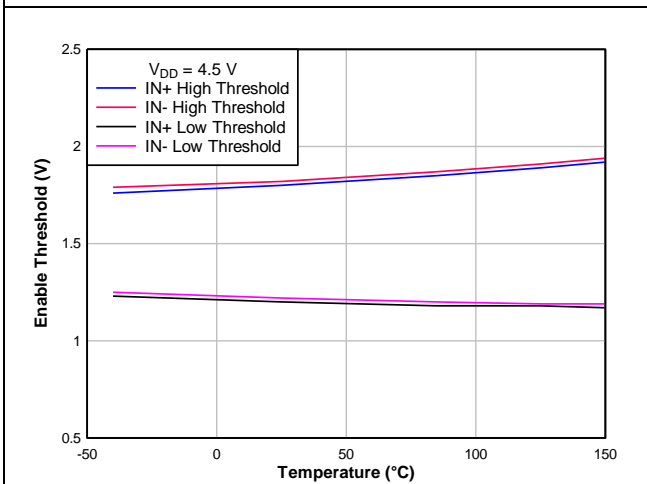

Figure 15 Enable Threshold vs Temperature

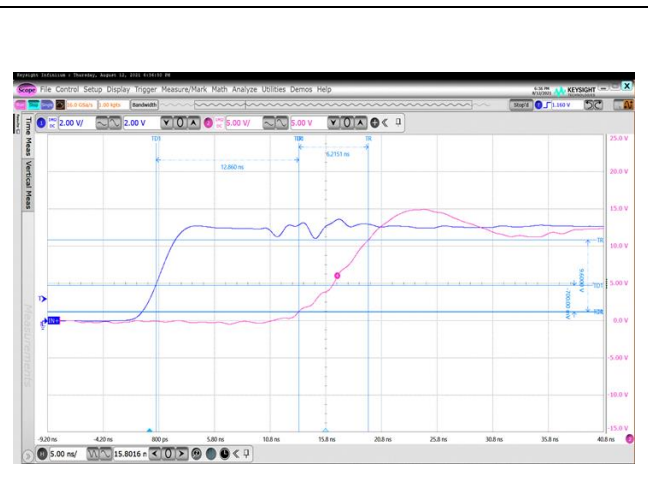

Figure 16 IN+ Rising Edge

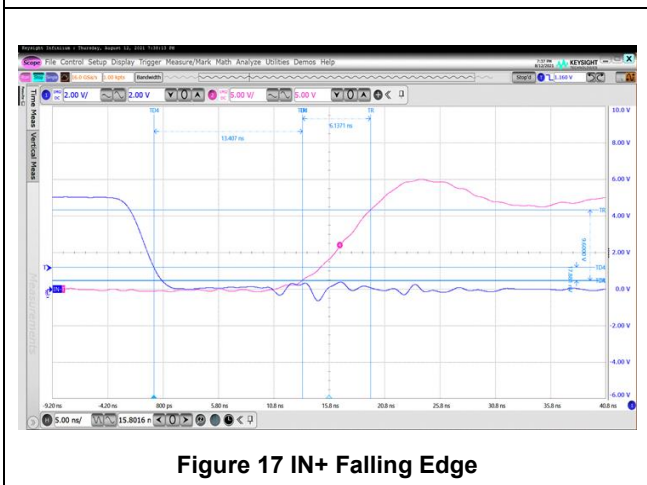

Figure 17 IN+ Falling Edge

Detailed Description

Overview

The TPM27517 single-channel low-side gate driver is designed for high performance power supplies, motor controls and inverters. Designed with the industrial standard of pin-out and package, the TPM27517 accelerates design process. With extended voltage ranges on supply voltage and negative input voltage, the TPM27517 improves system level reliability. Its 5-A strong driving capability improves gate driver efficiency and lowers heat generation, especially in high-frequency switching applications.

Functional Block Diagram

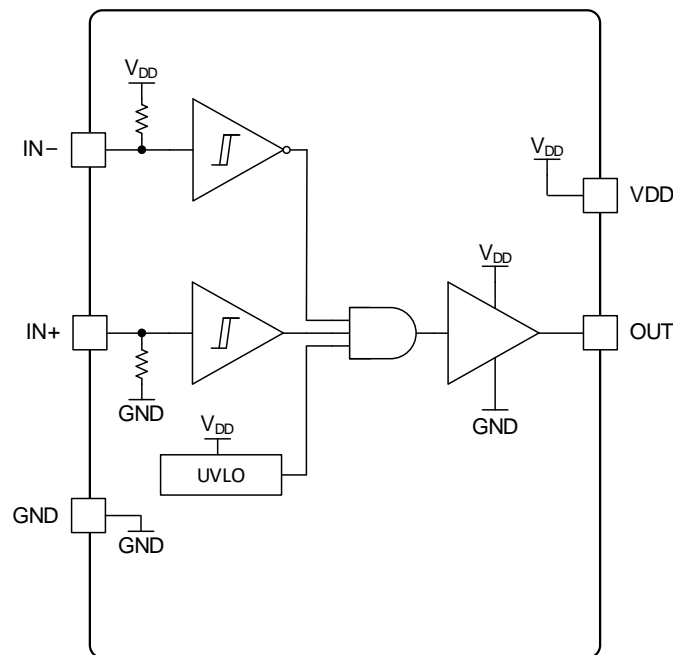

Figure 18 Functional Block Diagram

Feature Description

Low Propagation Delay Driver Output

The low-propagation-delay design between the device input and output allows the device to achieve the industrial leading performance. The low delay enhances the driver performance in high frequency switching regulators.

Supply and UVLO

The device monitors supply voltage with under-voltage lock-out (UVLO). When the supply voltage is below the UVLO threshold, the output is held low in UVLO to avoid glitches during power rising and falling. The device quiescent current and operating current are measured as shown in Figure 5. The current is related to internal quiescent current consumption as well as output current. The output current can be calculated using external transistor gate charge times switching frequency f_{sw} .

Channel Input

The input of the TPM27517 gate driver supports TTL and CMOS input with threshold voltage independent of supply voltage. The threshold is also designed as temperature independent to support a wide range of ambient temperature. Wide hysteresis enhances system level noise immunity. The integrated pull-down resistor sets the device in low state when the inputs are floating. The inputs can withstand DC -5 V to improve robustness on ground bouncing.

Output Stage

The TPM27517 output stage can deliver high current sourcing and sinking up to 5-A with low propagation delay.

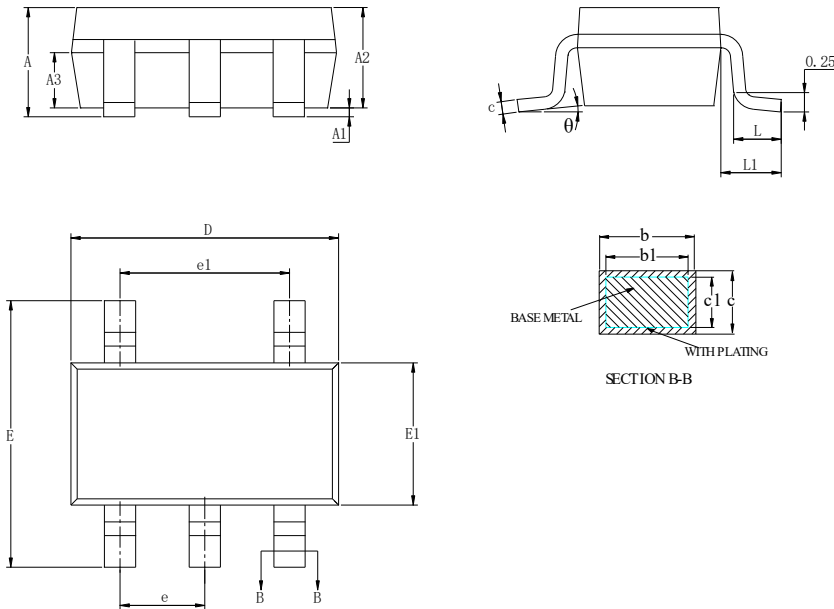
Package Outline Dimensions
SOT23-5

SYMBOL	MILLIMETER		
	MIN	NOM	MAX
A	—	—	1.25
A1	0.04	—	0.10
A2	1.00	1.10	1.20
A3	0.60	0.65	0.70
b	0.33	—	0.41
b1	0.32	0.35	0.38
c	0.15	—	0.19
c1	0.14	0.15	0.16
D	2.82	2.92	3.02
E	2.60	2.80	3.00
E1	1.50	1.60	1.70
e	0.95BSC		
e1	1.90BSC		
L	0.30	—	0.60
L1	0.60REF		
θ	0	—	8°

Single-Channel 5-A High-Speed, Low-Side Gate Driver**Order Information**

Order Number	Operating Temperature Range	Package	Marking Information	MSL	Transport Media, Quantity	Eco Plan
TPM27517-S5TR	-40°C – 125°C ⁽¹⁾	SOT23-5	M57	MSL3	3000	Green

(1) Ambient temperature indicates device operation condition range. Application thermal behavior needs to be taken care of when operating in high temperature scenarios.

Green: 3PEAK defines "Green" to mean RoHS compatible and free of halogen substances.

IMPORTANT NOTICE AND DISCLAIMER

Copyright© 3PEAK 2012-2023. All rights reserved.

Trademarks. Any of the 思瑞浦 or 3PEAK trade names, trademarks, graphic marks, and domain names contained in this document /material are the property of 3PEAK. You may NOT reproduce, modify, publish, transmit or distribute any Trademark without the prior written consent of 3PEAK.

Performance Information. Performance tests or performance range contained in this document/material are either results of design simulation or actual tests conducted under designated testing environment. Any variation in testing environment or simulation environment, including but not limited to testing method, testing process or testing temperature, may affect actual performance of the product.

Disclaimer. 3PEAK provides technical and reliability data (including data sheets), design resources (including reference designs), application or other design recommendations, networking tools, security information and other resources "As Is". 3PEAK makes no warranty as to the absence of defects, and makes no warranties of any kind, express or implied, including without limitation, implied warranties as to merchantability, fitness for a particular purpose or non-infringement of any third-party's intellectual property rights. Unless otherwise specified in writing, products supplied by 3PEAK are not designed to be used in any life-threatening scenarios, including critical medical applications, automotive safety-critical systems, aviation, aerospace, or any situations where failure could result in bodily harm, loss of life, or significant property damage. 3PEAK disclaims all liability for any such unauthorized use.