

Carbon Dioxide (CO₂) Transmitter (3-wired type) Operation Manual CD-300(G) / CD-300L(G)



CD-300(G)



CD-300L(G)
(with LCD Display)

General

CD-300(G) and CD-300L(G) Transmitter type models of CO₂ Sensor, which are for 0-20mA, 4-20mA Current output module or 0-10V, 2-10V Voltage output module (Jumper select). These models give 3-wired input power (2 PWR lines, 1 Common GND line).

Features

- **Non-Dispersive Infrared (NDIR) technology**
- **Either of four (2 Set of Analog Voltage or 2 set Current) output can be chosen by Jumper.** (4~20mA/2~10V/0~20mA/0~10V)
- **Customer could select multiple functions**
 - Factory calibration mode is available.
 - 10 minutes manual recalibration or weekly Auto-Calibration is settable.
- **Simple maintenance** (S-300(G) sensor is detachable from main board, which gives easier manipulation on sensor module.)
- **Size** : 123 x 69 x 40 (mm)

CD-300(G)/CD-300L(G) Transmitter Specifications

General Performance

Operating Temperature range

-10°C ~ 60°C

Operating Humidity range

0 ~ 95% RH (Non-condensing)

'G':0~99% RH(Non-condensing)

Storage Temperature

-30°C ~70°C

CO₂ Measurement

Sensing Method

NDIR (Non-dispersive Infrared)

Measurement Range

0 to 2,000 / 3,000 / 5,000 / 10,000ppm

(Jumper selectable)

(2%/3%/5%/7% are available)

Accuracy

±30ppm ±5%

Response Time(90%)

150 seconds

Sampling Interval

3 sec.

Operation mode selection

Factory calibration mode should be used
(Automatic calibration mode is only Indoor Air
Quality Monitoring).

Two manual recalibration methods are available with manual recalibration by change of J2 & J4 or by using TRB-100ST Jig (TRB-100ST Jig : On Sale)

Electrical Data

Input Power

24VDC ± 20% (3-Wired)

Output Signals

4 ~ 20mA or 2 ~ 10VDC

0 ~ 20mA or 0 ~ 10VDC

, (Jumper selectable

-voltage output or current output)

Dimensions (unit : mm)

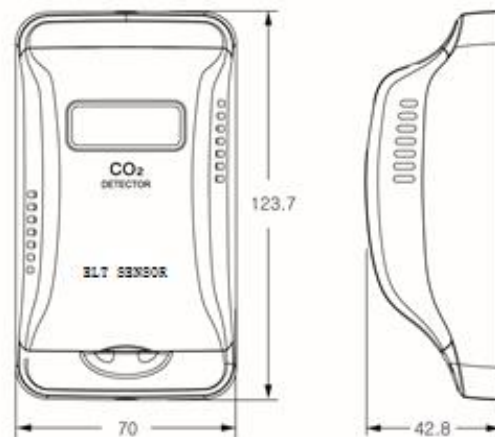

Front Inside View

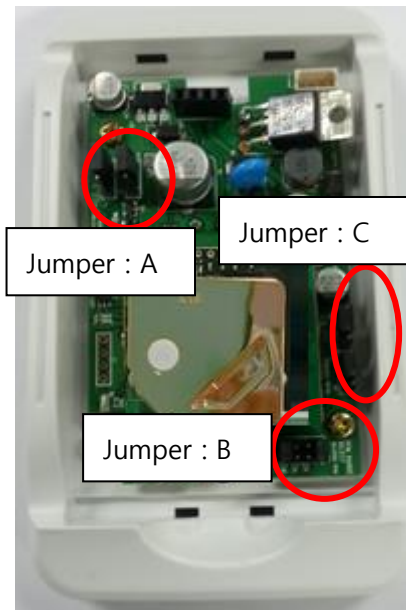

Rear View



Jumper Function Descriptions

■ **Jumper A (J7, J3) group : Voltage, Current output and range selection.**

V : Analog Voltage output

I : Current output

0~20mA : 0~20mA output @ Current.

0~10V output @ Voltage

4~20mA : 4~20mA output @ Current.

2~10V output @ Voltage.

● **[J7,J3] Output Mode**

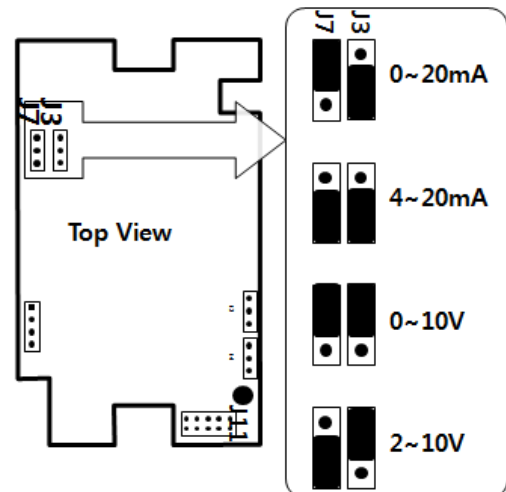

Example setting :



⇒ Current output and 0~ 20mA output

■ Jumper B(J11) group : CO2 Measurement range selection.

- 10K ppm : 0 ~ 10,000ppm CO2
- 5K ppm : 0 ~ 5,000ppm CO2
- 3K ppm : 0 ~ 3,000ppm CO2
- 2K ppm : 0 ~ 2,000ppm CO2

● [J11] PPM Measurement Range (Low range)

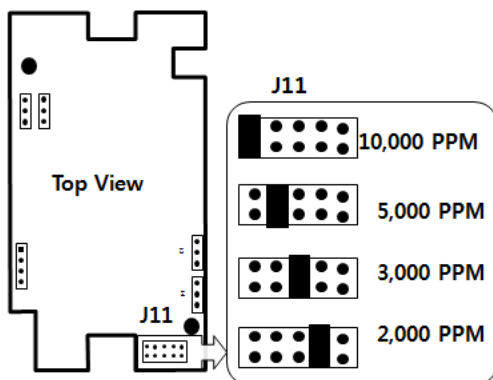

■ Jumper B(J11) group for High CO2 Measurement range selection.

- 70K ppm : 0 ~ 70,000ppm CO2
- 50K ppm : 0 ~ 50,000ppm CO2
- 30K ppm : 0 ~ 30,000ppm CO2
- 20K ppm : 0 ~ 20,000ppm CO2

● [J11] PPM Measurement Range (High range)

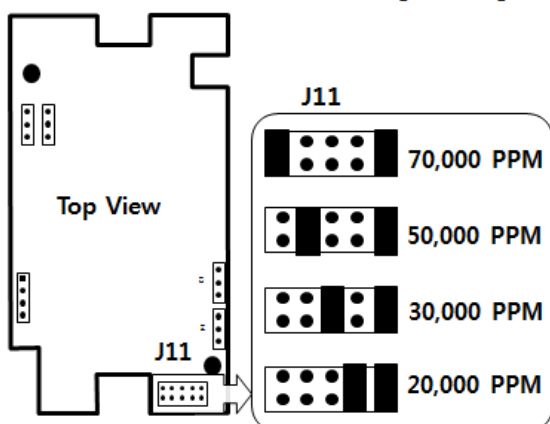

● [J2,J4] Operation Mode Selection with S-300(G) module

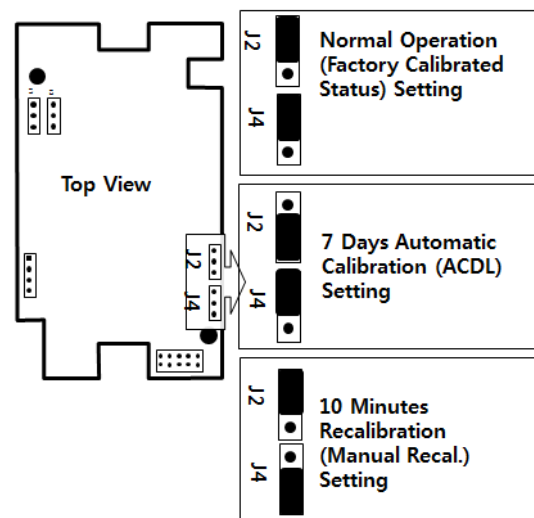

Example setting :



⇒ Weekly Auto-calibration or 10 minutes Manual-Calibration setting is available

Wiring Method

1. VIN+: 24VDC+,
2. VIN- : Common GND
3. A-OUT: Output signal

(Voltage or Current).

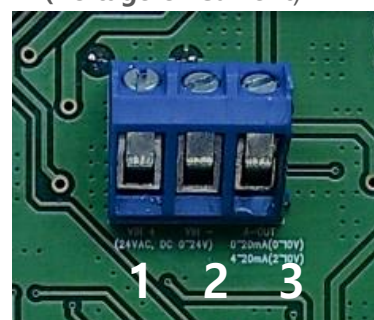

● [J13] Wiring Connector

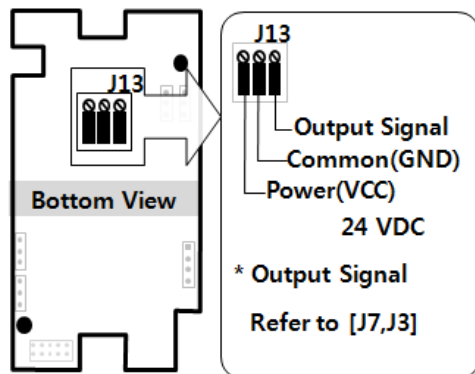

Output signal calculation examples

Ex) 3,000ppm range 0~10V mode.

Read voltage 3.234V

$$3,000\text{ppm} / 10\text{V} * 3.234 = 970 \text{ ppm.}$$

Ex) 3,000ppm range 2~10V mode.

Read voltage 3.234V

$$(3.234\text{V} - 2\text{V}) * (3000\text{ppm} / 8) = 462 \text{ ppm.}$$