

TYS Low Profile SMD Power Inductors

CATALOGUE



Laird[™]

ABOUT LAIRD TECHNOLOGIES

Laird Technologies designs and manufactures customized, performance-critical products for wireless and other advanced electronics applications.

The company is a global market leader in the design and supply of electromagnetic interference (EMI) shielding, thermal management products, mechanical actuation systems, signal integrity components, and wireless antennae solutions, as well as radio frequency (RF) modules and systems.

Laird Technologies partners with its customers to customize product solutions for applications in many industries including:

- Network Equipment
- Handsets
- Telecommunications
- Data Transfer & Information Technology
- Computers
- Automotive Electronics
- Aerospace
- Defense
- Medical Equipment
- Consumer Electronics
- Industrial

Laird Technologies offers its customers unique product solutions, dedication to research and development, as well as a seamless network of manufacturing and customer support facilities across the globe.



TABLE OF CONTENTS

Features and Applications	4
Part Number Explanation	4
Electrical Specifications	4
Product Selection Guide	5
Shapes and Dimensions	6
TYS Series 3010/3012/3015	7
TYS Series 4012/4018/4020/4030	9
TYS Series 5020/5040	11
TYS Series 6020/6028/6045	13
TYS Series 8040	15
Temperature Profile of Reflow Soldering	15
Packaging Information	16
Sample Kit Lists	17
Notes	18
Notes	19



All parts listed in this catalog are lead free and RoHS compliant.

NOTICE

Laird Technologies' products or subcomponents are not specifically designed or tested by Laird Technologies for use in any medical applications, surgical applications, medical device manufacturing, or any similar procedure or process requiring approval, testing, or certification by the United States food and drug administration or other similar Governmental entity. Applications with unusual environmental requirements such as military, medical, life-support or Life-sustaining equipment are specifically not recommended without additional testing for such application.

FEATURES AND APPLICATIONS

FEATURES

- Magnetic shielded structure
- Low DCR and high efficiency
- Low profile and small size
- High reliability

APPLICATIONS

- DC-DC converters and power suppliers
- LCD TV's, Blu-ray and gaming consoles
- Tablets, notebooks, servers and printers
- Smart phones, GPS, set top box and base stations
- LED lighting

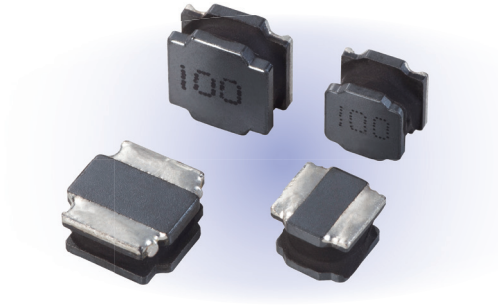

PART NUMBER EXPLANATION

T Y S	3 0 1 0	4 R 7	M	-	1 0
Product series code	Part size code	Inductance value code (i.e. 4R7: 4.7μH)	Tolerance % (i.e. M: ±20% , N:±30%)		Standard catalog part

Note:

Please contact territory sales for automotive inquiry and confirmation on an automotive grade component. If it is available, a new customized part number will be assigned for an automotive application.

ELECTRICAL SPECIFICATIONS

- Electrical specifications at 20°C
- Tolerance: M: ±20%, N:±30%
- Inductance tested at 100KHz, 1V
- RMS Current is defined based on temperature rise 40°C from 20°C ambient.
- Saturation Current is the DC current at which the inductance drops approximate 30% from its value without current.
- Operate temperature range: -40°C ~ +125°C(including self-heating temperature rise)
- Storage temperature range (packaging conditions):-10°C ~ 40°C and RH 70%(MAX.)

Note: RMS current is tested on a typical PCB and apply a constant current in still air. The temperature rise is dependent on the application system condition including PCB PAD pattern, trace width and thickness and adjacent components etc. It's suggest to verify the temperature rise of the component under the real operation application conditions.

TYS SERIES PRODUCT SELECTION GUIDE



PART SIZE CODE	DIMENSIONS	Inductance Range						PG NO.
		0.1 μ H	1 μ H	10 μ H	100 μ H	200 μ H	330 μ H	
3010	3.0 x 3.0 x 1.0	0.22	1 μ H — 47 μ H	1.4				7
3012	3.0 x 3.0 x 1.2	0.21	1 μ H — 100 μ H	1.87				7
3015	3.0 x 3.0 x 1.5	0.35	1 μ H — 47 μ H	2.32				7
4012	4.0 x 4.0 x 1.2	0.25	1 μ H — 100 μ H	2.61				9
4018	4.0 x 4.0 x 1.8	0.27	1 μ H — 220 μ H	4.8				9
4020	4.0 x 4.0 x 2.0	0.25	1 μ H — 100 μ H	4.78				9
4030	4.0 x 4.0 x 3.0	0.55	1 μ H — 120 μ H	5.26				9
5020	5.0 x 5.0 x 2.0		1 μ H — 22 μ H	1.15	4.1			11
5040	5.0 x 5.0 x 4.0		1 μ H — 100 μ H	0.75	7.35			11
6020	6.0 x 6.0 x 2.0		1 μ H — 22 μ H	1.05	4.15			13
6028	6.0 x 6.0 x 2.8		1 μ H — 100 μ H	0.65	5.75			13
6045	6.0 x 6.0 x 4.5		1 μ H — 330 μ H	0.57	9.85			13
8040	8.0 x 8.0 x 4.0		1 μ H — 330 μ H	0.68	9.85			15

SATURATION Current (A)

TYS SERIES SHAPES AND DIMENSIONS

SERIES (UNIT: mm)	FIGURE	A	B	C	D	E	a	b	c
TYS3010	A	3.0±0.2	3.0±0.2	1.0 +0.2/-0.3	0.75±0.2	1.50±0.2	2.3	0.8	2.7
TYS3012				1.2 +0.2/-0.3					
TYS3015				1.5 +0.2/-0.3					
TYS4012	B	4.0±0.2	4.0±0.2	1.2 +0.2/-0.3	1.30±0.3	1.40±0.3	2.7	1.5	4.0
TYS4018				1.8 +0.2/-0.3					
TYS4020				2.0Max.	0.95±0.2	2.10±0.2	3.0	1.1	3.7
TYS4030				3.0Max.	1.30±0.3	1.40±0.3	2.7	1.5	4.0
TYS5020	B	5.0±0.2	5.0±0.2	2.0 +0.2/-0.3	1.25±0.2	2.5±0.2	3.75	1.4	5.0
TYS5040				4.0 +0.2/-0.3					
TYS6020	B	6.0±0.3	6.0±0.3	2.0 +0.2/-0.3	1.60±0.3	2.8±0.3	4.4	1.8	6.0
TYS6028				2.8 +0.2/-0.3					
TYS6045				4.5 +0.2/-0.3	1.80±0.3	2.4±0.3	4.2	2.0	6.0
TYS8040	B	8.0±0.3	8.0±0.3	4.0 +0.2/-0.3	2.45±0.3	3.1±0.3	5.5	2.5	8.0

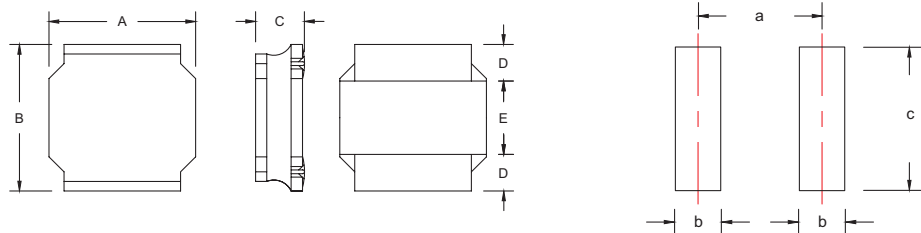
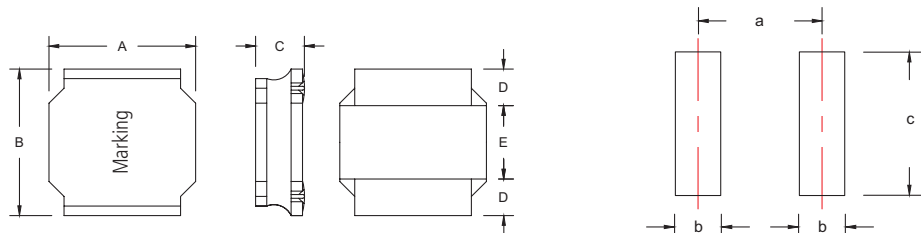
FIGURE A

FIGURE B

TYS SERIES 3010/3012/3015

ELECTRICAL SPECIFICATIONS

PART NO.	INDUCTANCE (μH)	R _{dc} (Ω) Max	SATURATION CURRENT (A)	RMS CURRENT (A)	SRF MHZ (REF)
TYS30101R0N-10	1	0.0850	1.40	1.45	180
TYS30101R5N-10	1.5	0.1040	1.27	1.30	120
TYS30102R2N-10	2.2	0.1430	1.15	1.09	100
TYS30103R3N-10	3.3	0.1890	0.97	0.96	74
TYS30104R7M-10	4.7	0.2930	0.75	0.77	59
TYS30106R8M-10	6.8	0.3970	0.55	0.66	42
TYS3010100M-10	10	0.5200	0.55	0.58	39
TYS3010150M-10	15	0.7930	0.42	0.47	30
TYS3010220M-10	22	1.2090	0.35	0.38	28
TYS3010330M-10	33	2.0150	0.29	0.30	18
TYS3010470M-10	47	2.5350	0.22	0.26	18
TYS30121R0N-10	1	0.0520	1.87	2.20	120
TYS30121R5N-10	1.5	0.0585	1.62	2.01	110
TYS30122R2N-10	2.2	0.0975	1.20	1.55	84
TYS30123R3M-10	3.3	0.1300	1.05	1.36	64
TYS30124R7M-10	4.7	0.1560	0.90	1.24	61
TYS30126R8M-10	6.8	0.2470	0.75	0.98	61
TYS3012100M-10	10	0.3445	0.60	0.83	42
TYS3012150M-10	15	0.5980	0.45	0.71	27
TYS3012220M-10	22	0.8385	0.42	0.53	23
TYS3012330M-10	33	1.1375	0.36	0.46	18
TYS3012470M-10	47	1.8850	0.27	0.35	14
TYS3012680M-10	68	2.1710	0.24	0.33	12
TYS3012101M-10	100	3.7180	0.21	0.25	12
TYS30151R0N-10	1	0.0450	2.32	2.35	150
TYS30151R5N-10	1.5	0.0650	2.30	1.70	100
TYS30152R2N-10	2.2	0.0780	1.60	1.60	86
TYS30153R3M-10	3.3	0.1140	1.32	1.36	68
TYS30154R7M-10	4.7	0.1625	1.10	1.09	46
TYS30156R8M-10	6.8	0.2600	0.85	0.85	39
TYS3015100M-10	10	0.3250	0.72	0.77	41
TYS3015150M-10	15	0.4940	0.66	0.65	30
TYS3015220M-10	22	0.5980	0.52	0.57	23
TYS3015330M-10	33	1.0660	0.44	0.43	20
TYS3015470M-10	47	1.6250	0.35	0.35	14

TYS SERIES 3010 / 3012 / 3015

TYPICAL ELECTRICAL CHARACTERISTICS

TYS3010 Typical L vs DC Current

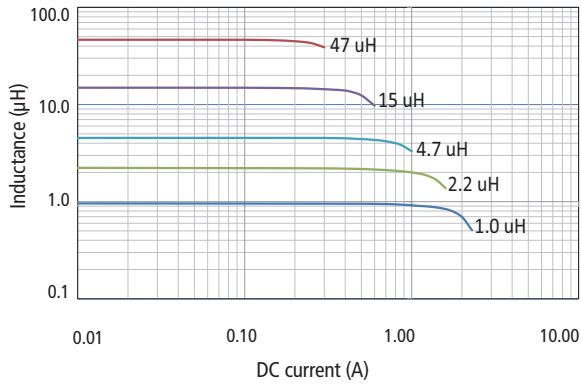

TYS3010 Temperature Rise vs DC Current

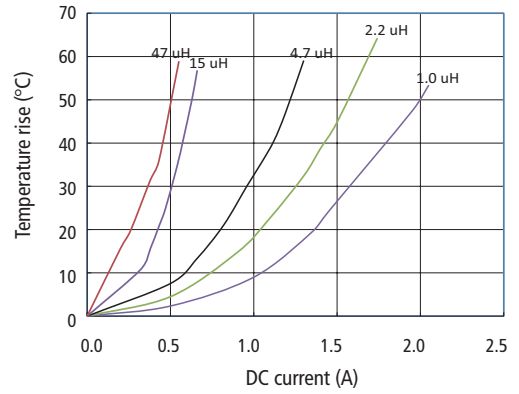

TYS3012 Typical L vs DC Current

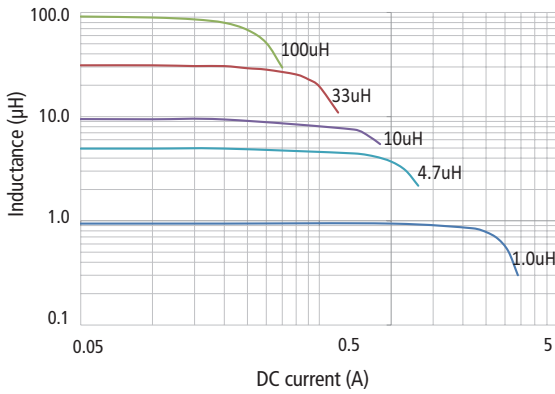

TYS3012 Temperature Rise vs DC Current

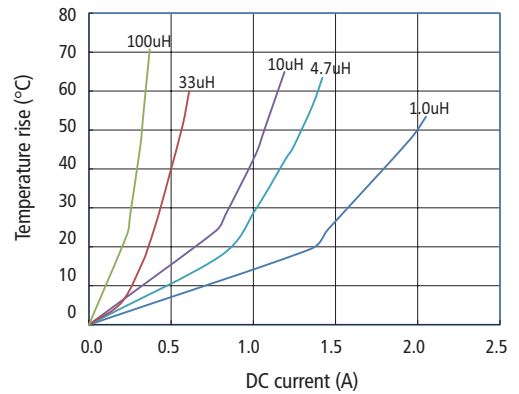

TYS3015 Typical L vs DC Current

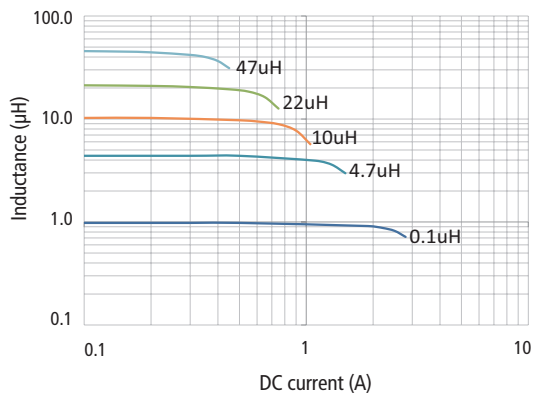

TYS3015 Temperature Rise vs DC Current

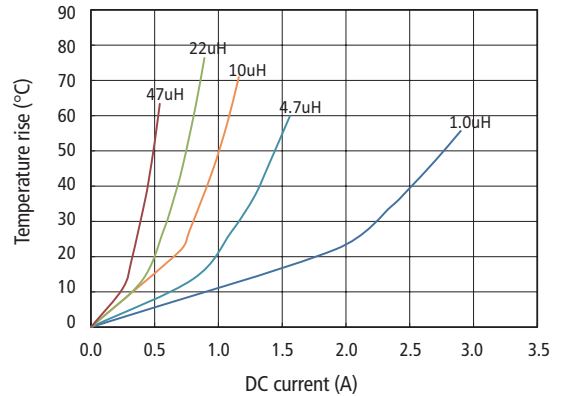

TYS SERIES 4012 / 4018 / 4020 / 4030

ELECTRICAL SPECIFICATIONS

PART NO.	INDUCTANCE (μH)	Rdc (Ω) Max	SATURATION CURRENT (A)	RMS CURRENT (A)	SRF MHZ (REF)
TYS40121R0N-10	1	0.0650	2.61	1.65	120
TYS40122R2N-10	2.2	0.1040	1.76	1.32	74
TYS40123R3N-10	3.3	0.1430	1.72	1.12	60
TYS40124R7N-10	4.7	0.1630	1.15	1.05	50
TYS40125R6N-10	5.6	0.1820	1.00	1.00	42
TYS40126R8M-10	6.8	0.2570	0.85	0.84	40
TYS4012100M-10	10	0.3450	0.80	0.77	33
TYS4012150M-10	15	0.4420	0.56	0.64	25
TYS4012220M-10	22	0.7630	0.46	0.49	20
TYS4012330M-10	33	1.0530	0.42	0.42	17
TYS4012470M-10	47	1.4300	0.35	0.37	12
TYS4012680M-10	68	2.5350	0.38	0.27	11
TYS4012101M-10	100	2.8730	0.25	0.25	9.4
TYS40181R0N-10	1	0.0325	4.80	2.00	80
TYS40182R2M-10	2.2	0.0590	2.70	1.65	52
TYS40184R7M-10	4.7	0.1170	1.70	1.20	34
TYS40186R8M-10	6.8	0.1430	1.45	1.06	29
TYS4018100M-10	10	0.2340	1.30	0.84	24
TYS4018150M-10	15	0.3250	0.94	0.65	19
TYS4018220M-10	22	0.4680	0.80	0.59	16
TYS4018330M-10	33	0.6890	0.65	0.49	12
TYS4018470M-10	47	0.8450	0.57	0.42	10
TYS4018680M-10	68	1.3000	0.47	0.32	8.3
TYS4018101M-10	100	2.2750	0.40	0.25	6.5
TYS4018151M-10	150	3.2500	0.31	0.22	5.5
TYS4018221M-10	220	5.2000	0.27	0.17	4
TYS40201R0N-10	1	0.0377	4.78	2.15	75
TYS40202R2N-10	2.2	0.0520	3.40	1.85	49
TYS40203R3M-10	3.3	0.0910	3.20	1.40	44
TYS40204R7M-10	4.7	0.0975	2.35	1.34	42
TYS40206R8M-10	6.8	0.1625	2.20	1.04	33
TYS4020100M-10	10	0.2145	1.60	0.90	26
TYS4020150M-10	15	0.2990	1.35	0.77	24
TYS4020220M-10	22	0.4550	1.05	0.62	15
TYS4020330M-10	33	0.7150	0.85	0.49	11
TYS4020470M-10	47	1.4300	0.35	0.37	12
TYS4020680M-10	68	2.5350	0.38	0.27	11
TYS4020101M-10	100	2.8370	0.25	0.25	9.4
TYS40301R0N-10	1	0.0182	5.26	4.15	70
TYS40301R5N-10	1.5	0.0260	4.84	3.34	62
TYS40302R2N-10	2.2	0.0390	4.90	2.95	52
TYS40303R3M-10	3.3	0.0520	3.30	2.40	38
TYS40304R7M-10	4.7	0.0780	2.90	2.00	31
TYS40306R8M-10	6.8	0.1170	2.75	1.60	24
TYS4030100M-10	10	0.1300	1.95	1.50	21
TYS4030150M-10	15	0.2470	1.65	1.11	16
TYS4030220M-10	22	0.2925	1.30	1.00	10
TYS4030330M-10	33	0.4290	1.10	0.84	10
TYS4030470M-10	47	0.6370	0.95	0.72	8.4
TYS4030680M-10	68	1.1284	0.72	0.52	7
TYS4030101M-10	100	1.4950	0.60	0.45	5.6
TYS4030121M-10	120	1.7550	0.55	0.42	5.4

TYS SERIES 4012 / 4018 / 4020 / 4030

TYPICAL ELECTRICAL CHARACTERISTICS

TYS4012 Typical L vs DC Current

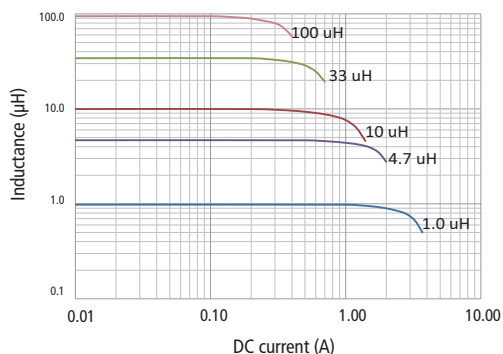

TYS4012 Temperature Rise vs DC Current

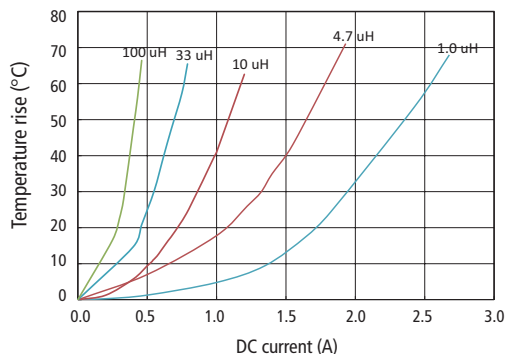

TYS4018 Typical L vs DC Current

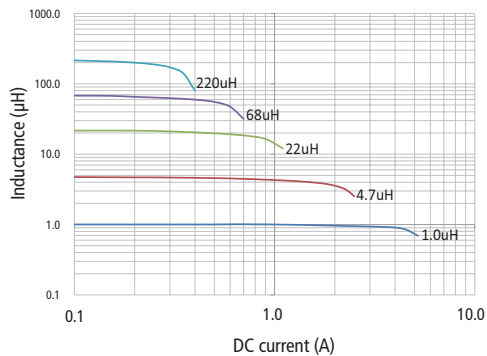

TYS4018 Temperature Rise vs DC Current

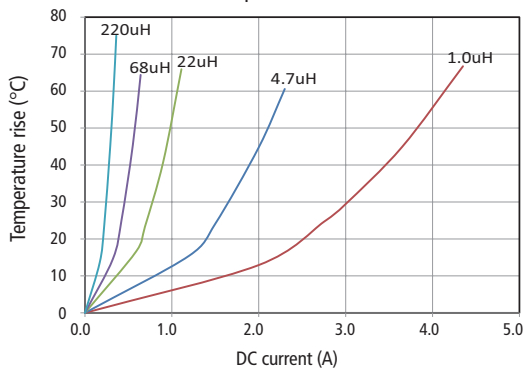

TYS4020 Typical L vs DC Current

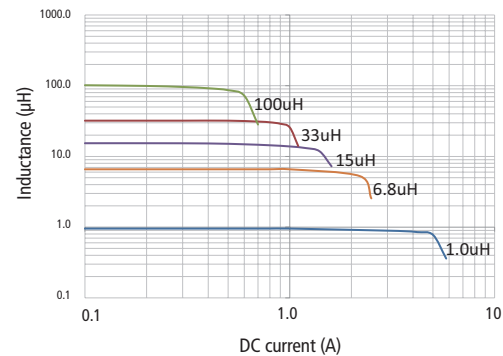

TYS4020 Temperature Rise vs DC Current

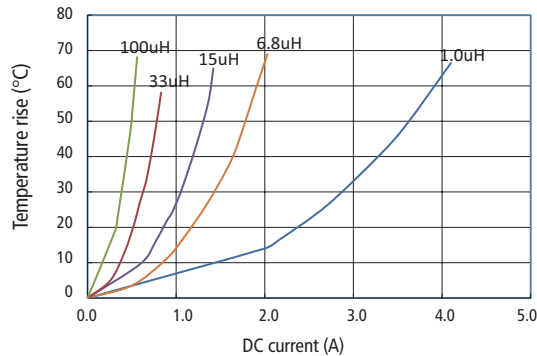

TYS4030 Typical L vs DC Current

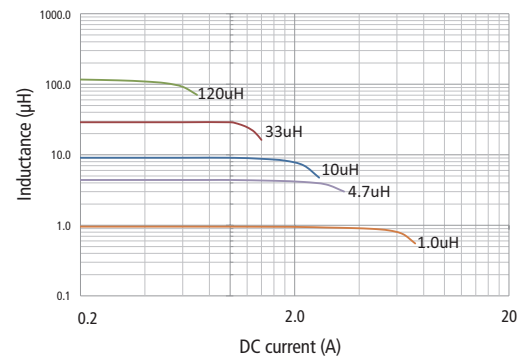

TYS4030 Temperature Rise vs DC Current

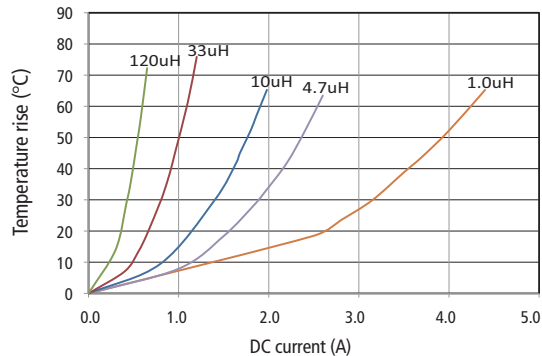

TYS SERIES 5020 / 5040

ELECTRICAL SPECIFICATIONS

PART NO.	INDUCTANCE (μ H)	R _{dc} (Ω) Max	SATURATION CURRENT (A)	RMS CURRENT (A)	SRF MHZ (REF)
TYS50201R0N-10	1	0.0260	4.10	3.80	114
TYS50201R5N-10	1.5	0.0340	4.10	3.20	68
TYS50202R2N-10	2.2	0.0416	3.20	2.90	57
TYS50203R3N-10	3.3	0.0560	2.55	2.50	46
TYS50203R6N-10	3.6	0.0560	2.80	2.50	43
TYS50204R7M-10	4.7	0.0740	2.50	2.20	37
TYS50206R8M-10	6.8	0.1080	2.05	1.80	30
TYS5020100M-10	10	0.1430	1.70	1.55	24
TYS5020150M-10	15	0.2150	1.35	1.25	20
TYS5020220M-10	22	0.2940	1.15	1.10	14
TYS50401R0N-10	1	0.0144	7.35	4.90	117
TYS50401R5N-10	1.5	0.0180	6.30	4.30	86
TYS50402R2N-10	2.2	0.0228	4.90	3.80	50
TYS50403R3N-10	3.3	0.0288	3.95	3.40	32
TYS50404R7N-10	4.7	0.0360	3.50	3.00	28
TYS50406R8M-10	6.8	0.0516	2.90	2.50	21
TYS5040100M-10	10	0.0768	2.35	2.10	18
TYS5040150M-10	15	0.1030	2.00	2.00	13
TYS5040220M-10	22	0.1550	1.60	1.50	11
TYS5040330M-10	33	0.2260	1.30	1.20	9.1
TYS5040470M-10	47	0.3260	1.10	1.00	6.7
TYS5040680M-10	68	0.4800	0.90	0.80	5.7
TYS5040101M-10	100	0.6720	0.75	0.70	4.7

TYS SERIES 5020 / 5040

TYPICAL ELECTRICAL CHARACTERISTICS

TYS5020 Typical L vs DC Current

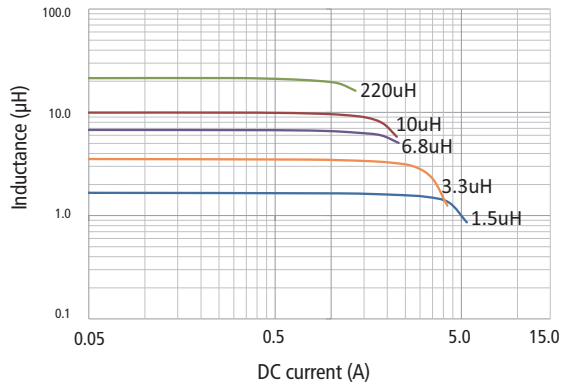

TYS5020 Temperature Rise vs DC Current

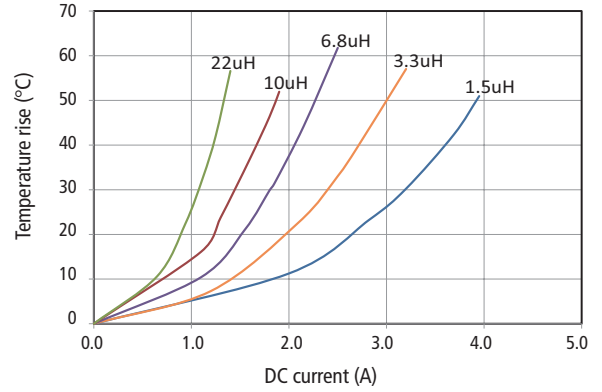

TYS5040 Typical L vs DC Current

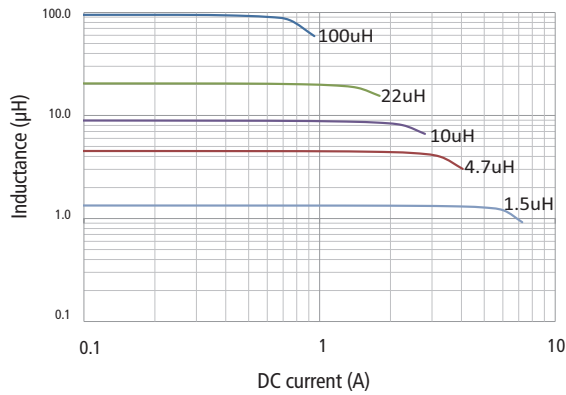

TYS5040 Temperature Rise vs DC Current

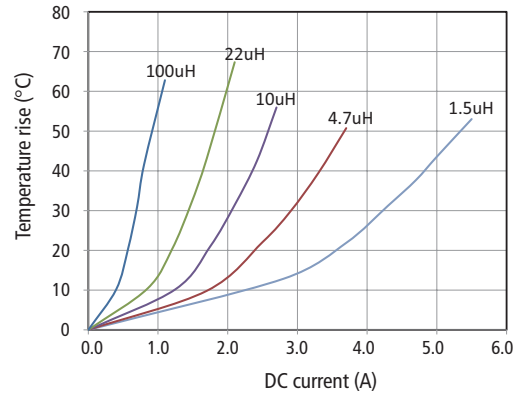

TYS SERIES 6020 / 6028 / 6045

ELECTRICAL SPECIFICATIONS

PART NO.	INDUCTANCE (μH)	Rdc (Ω) Max	SATURATION CURRENT (A)	RMS CURRENT (A)	SRF MHZ (REF)
TYS60201R0N-10	1	0.0260	4.15	3.50	100
TYS60201R5N-10	1.5	0.0286	4.25	3.20	79
TYS60202R2N-10	2.2	0.0364	3.75	2.75	61
TYS60203R3N-10	3.3	0.0455	3.15	2.60	51
TYS60204R7N-10	4.7	0.0754	3.00	2.00	41
TYS60206R8N-10	6.8	0.1027	2.20	1.80	31
TYS6020100M-10	10	0.1365	1.75	1.40	27
TYS6020220M-10	22	0.2652	1.05	1.00	16
TYS60281R0N-10	1	0.0130	5.75	5.20	70
TYS60281R3N-10	1.3	0.0169	6.00	4.58	65
TYS60281R5N-10	1.5	0.0169	6.00	4.58	65
TYS60282R2N-10	2.2	0.0260	5.10	3.75	48
TYS60283R3N-10	3.3	0.0325	4.15	3.48	41
TYS60284R7N-10	4.7	0.0390	3.00	3.08	35
TYS60286R8M-10	6.8	0.0611	2.60	2.40	27
TYS6028150M-10	15	0.1625	1.75	1.45	18
TYS6028220M-10	22	0.1820	1.45	1.40	14
TYS6028330M-10	33	0.2405	1.35	1.22	12
TYS6028470M-10	47	0.4095	1.15	1.06	9.5
TYS6028680M-10	68	0.4680	0.80	0.86	7.7
TYS6028101M-10	100	0.6500	0.65	0.70	7.1
TYS60451R0N-10	1	0.0143	9.85	5.14	100
TYS60451R3N-10	1.3	0.0130	8.35	5.40	100
TYS60451R5N-10	1.5	0.0156	8.80	4.95	65
TYS60451R8N-10	1.8	0.0156	7.60	4.95	74
TYS60452R2N-10	2.2	0.0182	6.75	4.60	52
TYS60452R3N-10	2.3	0.0273	6.00	3.50	60
TYS60453R0N-10	3	0.0260	5.60	3.80	35
TYS60453R3N-10	3.3	0.0273	5.90	3.70	32
TYS60454R5M-10	4.5	0.0338	4.97	3.30	24
TYS60454R7M-10	4.7	0.0338	4.97	3.30	24
TYS60456R3M-10	6.3	0.0455	4.43	3.00	26
TYS60456R8M-10	6.8	0.0403	3.90	3.00	20
TYS6045100M-10	10	0.0624	3.20	2.45	15
TYS6045150M-10	15	0.0884	2.50	2.05	12
TYS6045220M-10	22	0.1157	2.05	1.80	10
TYS6045470M-10	47	0.2600	1.40	1.20	6.4
TYS6045680M-10	68	0.3757	1.20	1.00	6.4
TYS6045101M-10	100	0.5630	0.95	0.80	4.2
TYS6045221M-10	220	1.0840	0.70	0.59	3.5
TYS6045331M-10	330	1.6510	0.57	0.57	2.8

TYS SERIES 6020 / 6028 / 6045

TYPICAL ELECTRICAL CHARACTERISTICS

TYS6020 Typical L vs DC Current

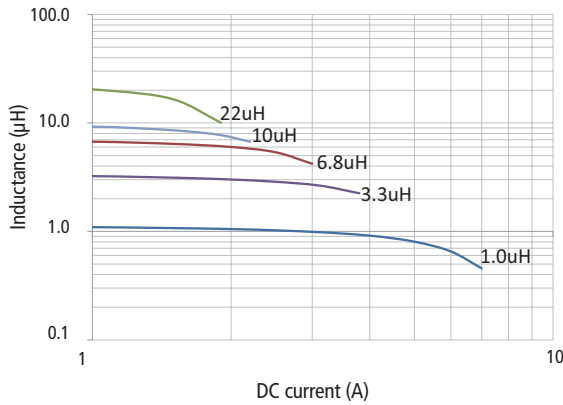

TYS6020 Temperature Rise vs DC Current

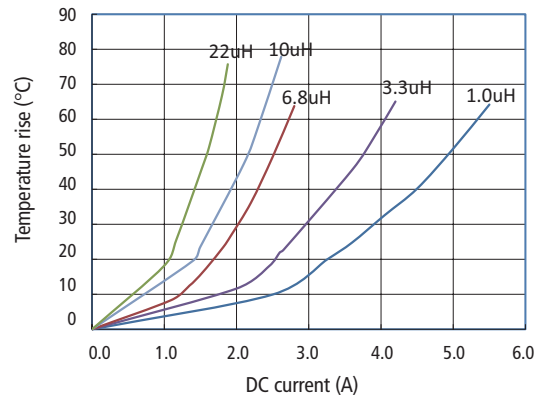

TYS6028 Typical L vs DC Current

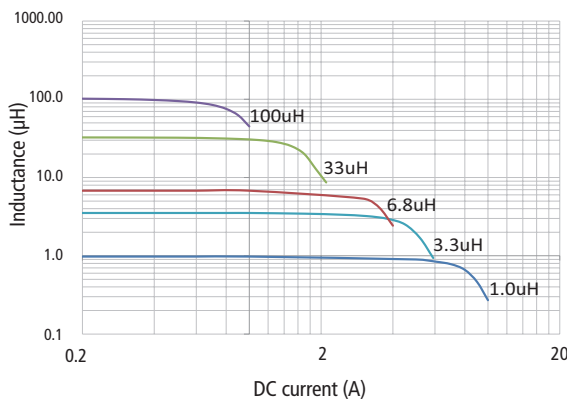

TYS6028 Temperature Rise vs DC Current

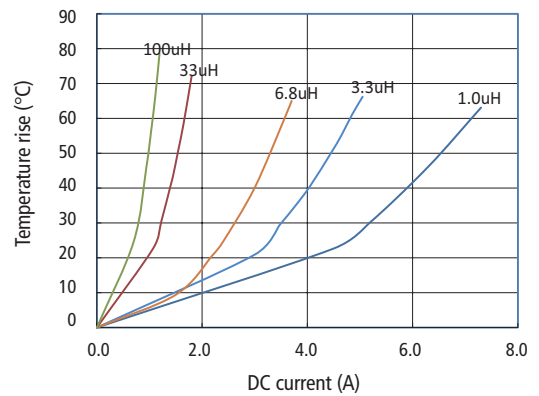

TYS6045 Typical L vs DC Current

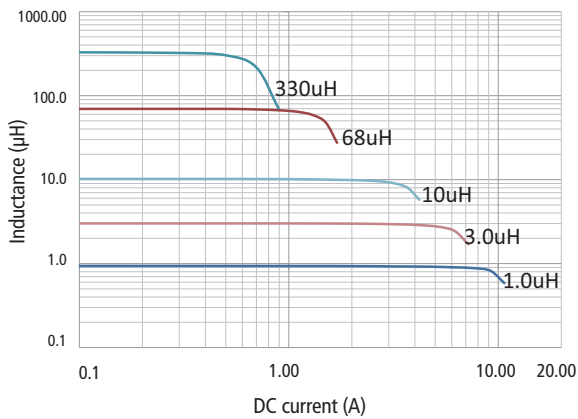

TYS6045 Temperature Rise vs DC Current

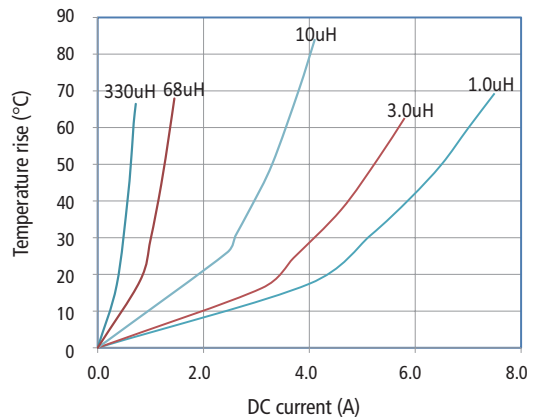

TYS SERIES 8040

ELECTRICAL SPECIFICATIONS

PART NO.	INDUCTANCE (μH)	Rdc (Ω) Max	SATURATION CURRENT (A)	RMS CURRENT (A)	SRF MHZ (REF)
TYS80401R0N-10	1	0.0104	9.85	6.30	89
TYS80401R4N-10	1.4	0.0130	8.15	5.65	67
TYS80402R0N-10	2	0.0156	9.25	5.15	43
TYS80402R2N-10	2.2	0.0156	7.10	5.15	41
TYS80403R3N-10	3.3	0.0221	6.50	4.40	27
TYS80403R6N-10	3.6	0.0221	7.52	4.35	30
TYS80404R7N-10	4.7	0.0247	5.90	4.10	24
TYS80406R8M-10	6.8	0.0312	4.55	3.60	20
TYS8040100M-10	10	0.0377	3.60	3.30	15
TYS8040220M-10	22	0.0897	2.40	2.10	9.5
TYS8040330M-10	33	0.1261	2.05	1.80	7.8
TYS8040470M-10	47	0.1768	1.75	1.55	6.4
TYS8040680M-10	68	0.2548	1.45	1.25	4.9
TYS8040101M-10	100	0.3770	1.15	1.00	4.2
TYS8040151M-10	150	0.5330	1.10	0.85	3.5
TYS8040221M-10	220	0.7787	0.85	0.80	3.5
TYS8040331M-10	330	1.1557	0.68	0.64	2.8

TYPICAL ELECTRICAL CHARACTERISTICS

TYS8040 Typical L vs DC Current

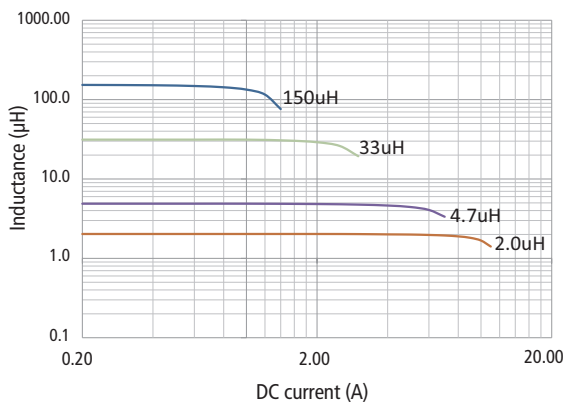

TYS8040 Temperature Rise vs DC Current

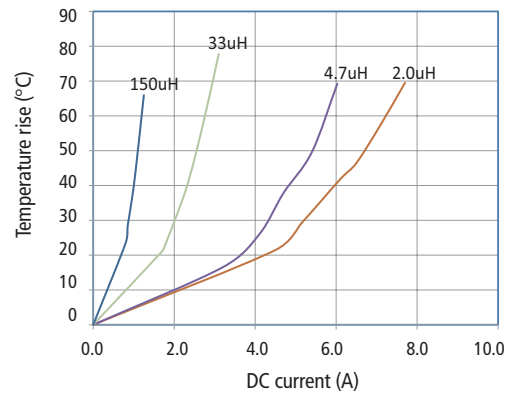

TEMPERATURE PROFILE OF REFLOW SOLDERING

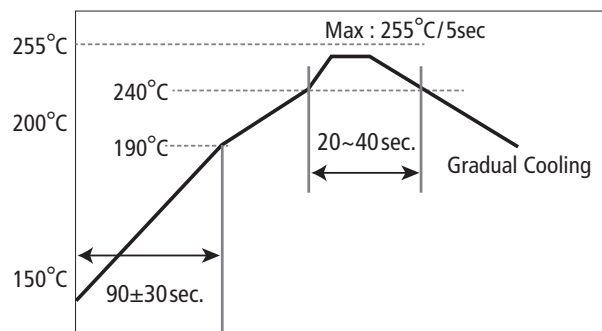

TYS SERIES PACKAGING INFORMATION

STANDARD QUANTITY

SERIES	TAPE AND REEL QUANTITY (PCS)
TYS3010	2000
TYS3012	2000
TYS3015	2000
TYS4012	4500
TYS4018	3000
TYS4020	3000
TYS4030	2000
TYS5020	2500
TYS5040	1500
TYS6020	2500
TYS6028	2000
TYS6045	1500
TYS8040	1000

TAPING DIMENSIONS

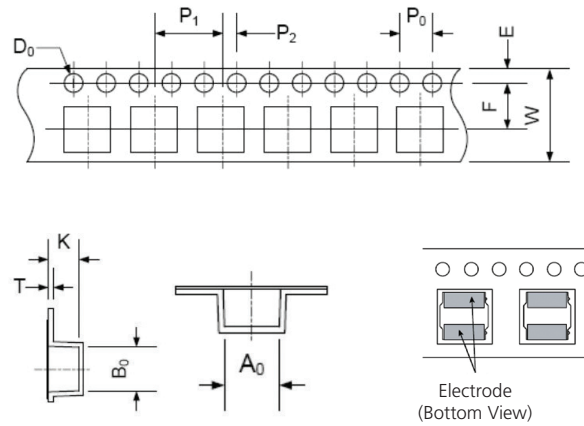

SERIES (UNIT: mm)	A ₀	B ₀	F	K	T	D ₀	P ₀	P ₁	P ₂	W	E		
TYS3010	3.3±0.1	3.3±0.1	3.5±0.05	1.4±0.1	0.25±0.03	1.5+0.1/-0	4±0.1	4±0.1	2±0.1	8±0.3	1.75±0.1		
TYS3012				1.6±0.1									
TYS3015				1.9±0.1									
TYS4012	4.3±0.1	4.3±0.1	5.5±0.05	1.4±0.1	0.35±0.03			4±0.1		8±0.1		2±0.1	12±0.3
TYS4018				2.1±0.1									
TYS4020				2.4±0.1									
TYS4030	5.4±0.1	5.4±0.1	5.5±0.1	3.2±0.1	0.4±0.03			4±0.1	8±0.1	2±0.1		12±0.3	
TYS5020				2.2±0.1									
TYS5040				4.2±0.1									
TYS6020	6.4±0.1	6.4±0.1	7.5±0.1	2.5±0.1	0.4±0.03			4±0.1	8±0.1	2±0.1		16±0.3	
TYS6028				3.3±0.1									
TYS6045				4.7±0.1									
TYS8040	8.35±0.1	8.35±0.1	8.35±0.1	4.4±0.1	4.4±0.1	4±0.1	8±0.1	2±0.1	16±0.3	1.75±0.1			

REEL DIMENSIONS

SERIES (UNIT: mm)	A	W1	W2	B	C	D	E	
TYS3010	178±2.0	8.4+1.5/-0.0	<14.4	58±2.0	2.45±0.2	/	13.5±0.2	
TYS3012								
TYS3015								
TYS4012	330	12.4+0.2/-0.0	<18.4	100	2.30±0.2	10.75±0.2	13.0+0.2/-0	
TYS4018								
TYS4020								
TYS4030								
TYS5020								
TYS5040								
TYS6020		16.4+0.2/-0.0	<22.4	<22.4	100	2.30±0.2	10.75±0.2	13.0+0.2/-0
TYS6028								
TYS6045								
TYS8040								

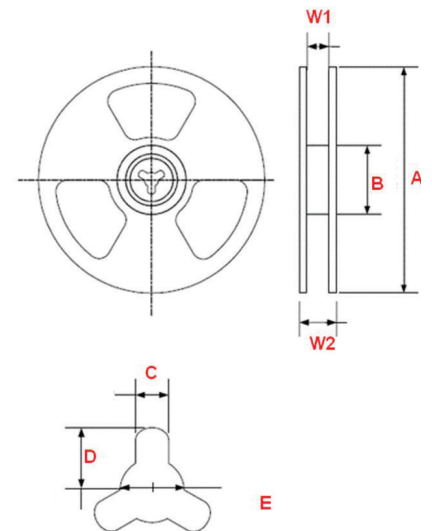

SAMPLE KIT LISTS

KIT NO:K-510 TYS IND

It contains parts of each single series as following lists

SERIES	PART NUMBER QTY	SAMPLE QTY / PN
TYS3010	11	5
TYS3012	13	5
TYS3015	11	5
TYS4012	13	5
TYS4018	13	5
TYS4020	12	5
TYS4030	14	5
TYS5020	10	5
TYS5040	13	5
TYS6020	8	5
TYS6028	13	5
TYS6045	20	5
TYS8040	17	3

NOTES



Americas: +1 800 634.2673 Option 1

Europe: +420 488.575277

Asia: +86 757.2563.8860

www.lairdtech.com

MCP-CAT-TYS SERIES 060117

Any information furnished by Laird Technologies, Inc. and its agents is believed to be accurate and reliable. All specifications are subject to change without notice. Responsibility for the use and application of Laird Technologies materials rests with the end user. Laird Technologies makes no warranties as to the fitness, merchantability, suitability or non-infringement of any Laird Technologies materials or products for any specific or general uses. Laird Technologies shall not be liable for incidental or consequential damages of any kind. All Laird Technologies products are sold pursuant to the Laird Technologies' Terms and Conditions of sale in effect from time to time, a copy of which will be furnished upon request. © Copyright 2016 Laird Technologies, Inc. All Rights Reserved. Laird, Laird Technologies, the Laird Technologies Logo, and other marks are trade marks or registered trade marks of Laird Technologies, Inc. or an affiliate company thereof. Other product or service names may be the property of third parties. Nothing herein provides a license under any Laird Technologies or any third party intellectual property rights. Version A02