

EFDKS

Metalized polypropylene film DC-link capacitors



Product features

- High capacitance density
- Self-healing property
- High ripple current and low loss
- High reliability

Applications

- Frequency converter, DC filtering
- Industrial power supply
- Solar inverter
- UPS
- AC Motor drive
- Air conditioner
- Switch mode power supplies (SMPS)

Environmental compliance and general specifications

- Operating temperature range: -40 °C to +105 °C



Part number system

EF	DK	S	45	K	505	G18	2L	H
Capacitor type	Family	Grade	Voltage (Vdc)	Tolerance	Capacitance (pF)	Size code	Terminal code	Lead length code
EF = film capacitors	Radial Leads DC Link	S = standard	45=450 55=550 60=600 70=700 80=800 90=900 1A=1000 1B=1100 1C=1200	J = ±5% K = ±10%	First two digits= significant figures, third digit = number of zeros example: 505 = 5000000 pF	Refer to size code table	Refer to terminal code table	Refer to lead length code table

Terminal code table

Digit one (Lead/terminal type)	Digit two (Lead Ipsilateral)	Lead length	Terminal code
2 leads for straight cut	2	10.2 mm	B
4 leads for straight cut	4	12.7 mm	G
		20.3 mm	D
		N/A	L

Lead length code table

Lead length	Terminal code
3.0±0.5 mm(Bulk)	D
3.5±0.5 mm(Bulk)	E
4.0±0.5 mm(Bulk)	F
4.5±0.5 mm(Bulk)	G
5.0±0.5 mm(Bulk)	H
5.5±0.5 mm(Bulk)	J
6.0±0.5 mm(Bulk)	K
6.5±0.5 mm(Bulk)	M
7.0±0.5 mm(Bulk)	N

Dimensions-mm

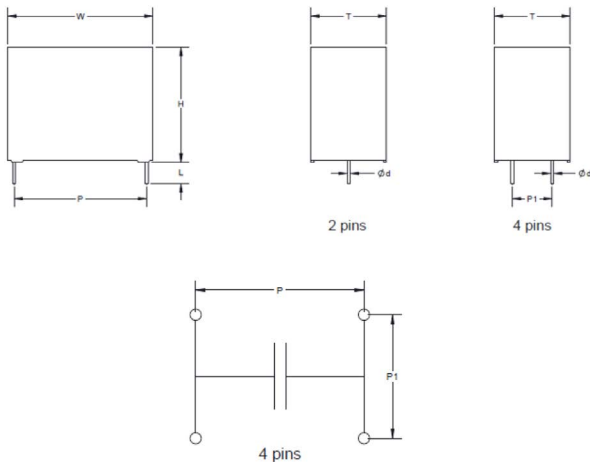

Part marking

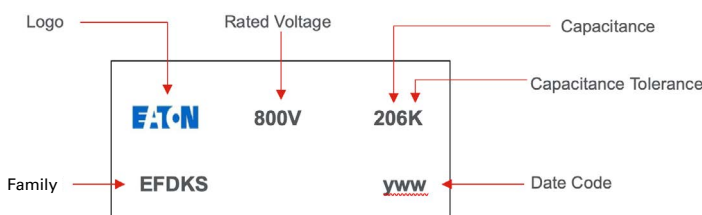

Size code table

Size	Dimension						Pitch				OD			Lead length
	Code	W	Tolerance (±)	H	Tolerance (±)	T	Tolerance (±)	P	Tolerance (±)	P1	Tolerance (±)	4 leads	2 leads	
D02	32	0.8	18	0.8	9	0.8	27.5	0.5	\	\	\	0.8	0.05	Refer to Lead Length Code Table
D03	32	0.8	20	0.8	11	0.8	27.5	0.5	\	\	\	0.8	0.05	
D04	32	0.8	22	0.8	13	0.8	27.5	0.5	\	\	\	0.8	0.05	
D06	32	0.8	24.5	0.8	13	0.8	27.5	0.5	\	\	\	0.8	0.05	
D07	32	0.8	24.5	0.8	15	0.8	27.5	0.5	\	\	\	0.8	0.05	
D08	32	0.8	28	0.8	14	0.8	27.5	0.5	\	\	\	0.8	0.05	
D10	32	0.8	30	0.8	16	0.8	27.5	0.5	\	\	\	0.8	0.05	
D12	32	0.8	33	0.8	18	0.8	27.5	0.5	\	\	\	0.8	0.05	
D13	32	0.8	37	0.8	22	0.8	27.5	0.5	10.2	0.5	1	0.8	0.05	
E07	42	1	30	1	17	1	37.5	0.5	\	\	\	1	0.05	
E10	42	1	32	1	19	1	37.5	0.5	\	\	\	1	0.05	
E11	42	1	37	1	22	1	37.5	0.5	10.2	0.5	1.2	1	0.05	
E12	42	1	37	1	28	1	37.5	0.5	10.2	0.5	1.2	1	0.05	
E13	42	1	40	1	20	1	37.5	0.5	10.2	0.5	1.2	1	0.05	
E14	42	1	43	1	28	1	37.5	0.5	10.2	0.5	1.2	1	0.05	
E15	42	1	44	1	24	1	37.5	0.5	10.2	0.5	1.2	1	0.05	
E16	42	1	45	1	30	1	37.5	0.5	20.3	0.5	1.2	1	0.05	
E17	42	1	50	1	35	1	37.5	0.5	20.3	0.5	1.2	1	0.05	
E18	42	1	55	1	40	1	37.5	0.5	20.3	0.5	1.2	1	0.05	
E19	42	1	60	1	45	1	37.5	0.5	20.3	0.5	1.2	1	0.05	
F01	57.5	1	45	1	25	1	52.5	0.5	10.2	0.5	1.2	1.2	0.05	
F02	57.5	1	45	1	30	1	52.5	0.5	20.3	0.5	1.2	1.2	0.05	
F03	57.5	1	50	1	35	1	52.5	0.5	20.3	0.5	1.2	1.2	0.05	
F04	57.5	1	55	1	45	1	52.5	0.5	20.3	0.5	1.2	1.2	0.05	
F06	57.5	1	65	1	45	1	52.5	0.5	20.3	0.5	1.2	1.2	0.05	

Remark: case color is black.

Rating and part number

Rated voltage 450 Vdc

Capacitance value (μF)	Dimensions					I _{rms} +70 °C, 10 kHz (A)	Peak current (A)	Surge current (A)	ESR 10 kHz (mΩ)	ESL (nH)	Thermal resistance (°C/W)	dv/dt (V/μs)	Lead wire diameter (mm)	Part number ¹
	W (mm)	H (mm)	T (mm)	P (mm)	P1 (mm)									
5	32	20	11	27.5	\	5.0	325	975	20	25	30	65	0.8	EFDKS45K505D032LH
10	32	24.5	15	27.5	\	7.0	650	1950	11	25	27.8	65	0.8	EFDKS45K106D072LH
15	32	33	18	27.5	\	11	975	2925	7.0	25	17.7	65	0.8	EFDKS45K156D122LH
22	32	37	22	27.5	\	11	1430	4290	5.0	27	24.8	65	0.8	EFDKS45K226D132LH
25	32	37	22	27.5	\	12	1625	4875	4.8	27	24.8	65	0.8	EFDKS45K256D132LH
30	42	40	20	37.5	10.2	12.5	1050	3150	7.5	30	12.8	35	1.2	EFDKS45K306E134BH
35	42	37	22	37.5	10.2	13.5	1225	3675	7.0	30	11.8	35	1.2	EFDKS45K356E114BH
40	42	37	28	37.5	10.2	14.5	1400	4200	6.2	30	11.5	35	1.2	EFDKS45K406E124BH
50	42	43	28	37.5	10.2	16	1750	5250	5.0	30	11.7	35	1.2	EFDKS45K506E144BH
50	42	45	30	37.5	20.3	16	1750	5250	5.0	30	11.7	35	1.2	EFDKS45K506E164DH
60	42	45	30	37.5	20.3	16.5	2100	6300	4.5	30	12.2	35	1.2	EFDKS45K606E164DH
80	42	50	35	37.5	20.3	20.5	2800	8400	3.8	30	12.2	35	1.2	EFDKS45K806E174DH
110	42	60	45	37.5	20.3	24.5	3850	11550	3.6	30	12.2	35	1.2	EFDKS45K117E194DH
130	42	60	45	37.5	20.3	28.5	4550	13650	3.0	30	12.2	35	1.2	EFDKS45K137E194DH
75	57.5	45	30	52.5	20.3	16.5	1500	4500	5.5	35	10	20	1.2	EFDKS45K756F024DH
80	57.5	45	30	52.5	20.3	17	1600	4800	5.0	35	10.4	20	1.2	EFDKS45K806F024DH
100	57.5	50	35	52.5	20.3	18	2000	6000	4.5	35	10.3	20	1.2	EFDKS45K107F034DH
110	57.5	50	35	52.5	20.3	19	2200	6600	4.0	35	10.4	20	1.2	EFDKS45K117F034DH
120	57.5	50	35	52.5	20.3	21.5	2400	7200	3.8	35	10.4	20	1.2	EFDKS45K127F034DH
160	57.5	55	45	52.5	20.3	28.5	3200	9600	3.0	35	10.4	20	1.2	EFDKS45K167F044DH
200	57.5	65	45	52.5	20.3	33	4000	12000	2.6	35	10.4	20	1.2	EFDKS45K207F064DH

1. Standard part numbers listed--addition configurations available for tolerance, terminal and lead length. See part number system for available tolerances and terminal and lead length tables for available options.

Rating and part number

Rated voltage 550 Vdc

Capacitance value (μF)	Dimensions					I _{rms} +70 °C, 10 kHz (A)	Peak current (A)	Surge current (A)	ESR 10 kHz (mΩ)	ESL (nH)	Thermal resistance (°C/W)	dv/dt (V/μs)	Lead wire diameter (mm)	Part number ¹
	W (mm)	H (mm)	T (mm)	P (mm)	P1 (mm)									
5	32	22	13	27.5	\	5.5	325	975	19.5	25	25.4	65	0.8	EFDKS55K505D042LH
10	32	33	18	27.5	\	7.5	650	1950	10.5	25	25.4	65	0.8	EFDKS55K106D122LH
15	32	37	22	27.5	\	11.5	975	2925	6.8	27	16.7	65	0.8	EFDKS55K156D132LH
22	32	37	22	27.5	\	11.5	1430	4290	4.9	27	23.1	65	0.8	EFDKS55K226D132LH
30	42	44	24	37.5	10.2	13	1050	3150	7.2	30	12.3	35	1.2	EFDKS55K306E154BH
35	42	45	30	37.5	20.3	13.8	1225	3675	6.8	30	11.6	35	1.2	EFDKS55K356E164DH
40	42	45	30	37.5	20.3	14.8	1400	4200	6.0	30	11.4	35	1.2	EFDKS55K406E164DH
50	42	50	35	37.5	20.3	17	1750	5250	4.8	30	10.8	35	1.2	EFDKS55K506E174DH
60	42	50	35	37.5	20.3	18	2100	6300	4.2	30	11	35	1.2	EFDKS55K606E174DH
70	42	50	35	37.5	20.3	20.5	2450	7350	3.8	30	11	35	1.2	EFDKS55K706E174DH
110	42	60	45	37.5	20.3	24.5	3850	11550	3.6	30	11	35	1.2	EFDKS55K117E194DH
75	57.5	45	30	52.5	20.3	16.8	1500	4500	5.2	35	10.2	20	1.2	EFDKS55K756F024DH
100	57.5	50	35	52.5	20.3	18.5	2000	6000	4.3	35	10.2	20	1.2	EFDKS55K107F034DH
110	57.5	50	35	52.5	20.3	20	2200	6600	4.0	35	9.4	20	1.2	EFDKS55K117F034DH
140	57.5	55	45	52.5	20.3	26	2800	8400	3.5	35	6.3	20	1.2	EFDKS55K147F044DH
170	57.5	65	45	52.5	20.3	32	3400	10200	2.8	35	5.2	20	1.2	EFDKS55K177F064DH
180	57.5	65	45	52.5	20.3	33	3600	10800	2.6	35	5.2	20	1.2	EFDKS55K187F064DH

1. Standard part numbers listed---addition configurations available for tolerance, terminal and lead length. See part number system for available tolerances and terminal and lead length tables for available options.

Rating and part number

Rated voltage 600 Vdc

Capacitance value (μF)	Dimensions					I _{rms} +70 °C, 10 kHz (A)	Peak current (A)	Surge current (A)	ESR 10 kHz (mΩ)	ESL (nH)	Thermal resistance (°C/W)	dv/dt (V/μs)	Lead wire diameter (mm)	Part number ¹
	W (mm)	H	T (mm)	P (mm)	P1 (mm)									
2	32	18	9	27.5	\	2.9	130	390	40	25	44.6	65	0.8	EFDKS60K205D022LH
3	32	20	11	27.5	\	4.0	195	585	28	25	33.5	65	0.8	EFDKS60K305D032LH
4	32	20	11	27.5	\	5.5	260	780	23	25	21.6	65	0.8	EFDKS60K405D032LH
5	32	22	13	27.5	\	7.0	325	975	14.5	25	21.1	65	0.8	EFDKS60K505D042LH
6	32	24.5	15	27.5	\	7.3	390	1170	13.	25	21.7	65	0.8	EFDKS60K605D072LH
7	32	24.5	15	27.5	\	8.5	455	1365	12	25	17.3	65	0.8	EFDKS60K705D072LH
8	32	28	14	27.5	\	9.5	520	1560	11	25	15.1	65	0.8	EFDKS60K805D082LH
9	32	30	16	27.5	\	10.5	585	1755	10.5	25	13	65	0.8	EFDKS60K905D102LH
10	32	30	16	27.5	\	11	650	1950	10	25	12.4	65	0.8	EFDKS60K106D102LH
12	32	33	18	27.5	\	12	780	2340	9.5	25	11	65	0.8	EFDKS60K126D122LH
15	32	37	22	27.5	\	12	975	2925	9.5	27	11	65	0.8	EFDKS60K156D132LH
15	32	37	22	27.5	10.2	14.5	975	2925	7.0	27	10.2	65	1	EFDKS60K156D134BH
18	32	37	22	27.5	\	12.5	1170	3510	9.0	27	10.7	65	0.8	EFDKS60K186D132LH
18	32	37	22	27.5	10.2	16.5	1170	3510	6.0	27	9.2	65	1	EFDKS60K186D134BH
10	42	30	17	37.5	\	7.0	350	1050	18	28	17	35	1	EFDKS60K106E072LH
12	42	30	17	37.5	\	8.0	420	1260	12	28	19.5	35	1	EFDKS60K126E072LH
15	42	32	19	37.5	\	9.5	525	1575	11	28	15.1	35	1	EFDKS60K156E102LH
20	42	40	20	37.5	10.2	12.5	700	2100	9.0	30	10.7	35	1.2	EFDKS60K206E134BH
22	42	40	20	37.5	10.2	13.5	770	2310	8.0	30	10.3	35	1.2	EFDKS60K226E134BH
25	42	40	20	37.5	10.2	15.5	875	2625	7.0	30	8.9	35	1.2	EFDKS60K256E134BH
30	42	44	24	37.5	10.2	16.5	1050	3150	6.5	30	8.5	35	1.2	EFDKS60K306E154BH
35	42	45	30	37.5	20.3	18.5	1225	3675	6.0	30	7.3	35	1.2	EFDKS60K356E164DH
40	42	45	30	37.5	20.3	20.5	1400	4200	5.0	30	7.1	35	1.2	EFDKS60K406E164DH
45	42	50	35	37.5	20.3	23	1575	4725	4.5	30	6.3	35	1.2	EFDKS60K456E174DH
50	42	50	35	37.5	20.3	25	1750	5250	4.0	30	6.0	35	1.2	EFDKS60K506E174DH
60	42	55	40	37.5	20.3	27	2100	6300	3.8	30	5.4	35	1.2	EFDKS60K606E184DH
70	42	55	40	37.5	20.3	29	2450	7350	3.5	30	5.1	35	1.2	EFDKS60K706E184DH
75	42	60	45	37.5	20.3	30	2625	7875	3.0	30	5.6	35	1.2	EFDKS60K756E194DH
80	42	60	45	37.5	20.3	32	2800	8400	2.8	30	5.2	35	1.2	EFDKS60K806E194DH
85	42	60	45	37.5	20.3	34	2975	8925	2.5	30	5.2	35	1.2	EFDKS60K856E194DH
40	57.5	45	25	52.5	10.2	13.5	800	2400	8.0	35	10.3	20	1.2	EFDKS60K406F014BH
45	57.5	45	25	52.5	10.2	14	900	2700	7.5	35	10.2	20	1.2	EFDKS60K456F014BH
50	57.5	45	25	52.5	10.2	15.5	1000	3000	7.0	35	8.9	20	1.2	EFDKS60K506F014BH
55	57.5	45	30	52.5	20.3	17	1100	3300	6.2	35	8.4	20	1.2	EFDKS60K556F024DH
60	57.5	45	30	52.5	20.3	18.5	1200	3600	6.0	35	7.3	20	1.2	EFDKS60K606F024DH
65	57.5	50	35	52.5	20.3	20	1300	3900	5.5	35	6.8	20	1.2	EFDKS60K656F034DH

1. Standard part numbers listed---addition configurations available for tolerance, terminal and lead length. See part number system for available tolerances and terminal and lead length tables for available options.

Rating and part number

Rated voltage 600 Vdc

Capacitance value (μF)	Dimensions					I _{rms} +70 °C, 10 kHz (A)	Peak current (A)	Surge current (A)	ESR 10 kHz (mΩ)	ESL (nH)	Thermal resistance (°C/W)	dv/dt (V/μs)	Lead wire diameter (mm)	Part number ¹
	W (mm)	H (mm)	T (mm)	P (mm)	P1 (mm)									
70	57.5	50	35	52.5	20.3	21.5	1400	4200	5.0	35	6.5	20	1.2	EFDKS60K706F034DH
75	57.5	50	35	52.5	20.3	23.5	1500	4500	4.5	35	6.0	20	1.2	EFDKS60K756F034DH
80	57.5	50	35	52.5	20.3	24.5	1600	4800	4.2	35	5.9	20	1.2	EFDKS60K806F034DH
90	57.5	55	45	52.5	20.3	26	1800	5400	4.0	35	5.5	20	1.2	EFDKS60K906F044DH
100	57.5	55	45	52.5	20.3	29	2000	6000	3.4	35	5.2	20	1.2	EFDKS60K107F044DH
110	57.5	55	45	52.5	20.3	30	2200	6600	3.0	35	5.6	20	1.2	EFDKS60K117F044DH
120	57.5	65	45	52.5	20.3	32	2400	7200	2.8	35	5.2	20	1.2	EFDKS60K127F064DH
130	57.5	65	45	52.5	20.3	33	2600	7800	2.6	35	5.3	20	1.2	EFDKS60K137F064DH
140	57.5	65	45	52.5	20.3	34	2800	8400	2.5	35	5.2	20	1.2	EFDKS60K147F064DH

1. Standard part numbers listed--addition configurations available for tolerance, terminal and lead length. See part number system for available tolerances and terminal and lead length tables for available options.

Rating and part number

Rated voltage 700 Vdc

Capacitance value (μF)	Dimensions					I _{rms} +70 °C, 10 kHz (A)	Peak current (A)	Surge current (A)	ESR 10 kHz (mΩ)	ESL (nH)	Thermal resistance (°C/W)	dv/dt (V/μs)	Lead wire diameter (mm)	Part number ¹
	W (mm)	H (mm)	T (mm)	P (mm)	P1 (mm)									
2	32	18	9	27.5	\	2.9	130	390	40	25	44.6	65	0.8	EFDKS70K205D022LH
3	32	20	11	27.5	\	4.0	195	585	28	25	33.5	65	0.8	EFDKS70K305D032LH
4	32	20	11	27.5	\	5.5	260	780	23	25	21.6	65	0.8	EFDKS70K405D032LH
5	32	22	13	27.5	\	7.0	325	975	14.5	25	21.1	65	0.8	EFDKS70K505D042LH
6	32	24.5	15	27.5	\	7.3	390	1170	13	25	21.7	65	0.8	EFDKS70K605D072LH
7	32	24.5	15	27.5	\	8.5	455	1365	12	25	17.3	65	0.8	EFDKS70K705D072LH
8	32	28	14	27.5	\	9.5	520	1560	11	25	15.1	65	0.8	EFDKS70K805D082LH
9	32	30	16	27.5	\	10.5	585	1755	10.5	25	13	65	0.8	EFDKS70K905D102LH
10	32	30	16	27.5	\	11.0	650	1950	10	25	12.4	65	0.8	EFDKS70K106D102LH
12	32	33	18	27.5	\	12.0	780	2340	9.5	25	11	65	0.8	EFDKS70K126D122LH
15	32	37	22	27.5	\	12.0	975	2925	9.5	27	11	65	0.8	EFDKS70K156D132LH
15	32	37	22	27.5	10.2	14.5	975	2925	7.0	27	10.2	65	1	EFDKS70K156D134BH
18	32	37	22	27.5	\	12.5	1170	3510	9.0	27	10.7	65	0.8	EFDKS70K186D132LH
18	32	37	22	27.5	10.2	16.5	1170	3510	6.0	27	9.2	65	1	EFDKS70K186D134BH
10	42	30	17	37.5	\	7.0	350	1050	18	28	17	35	1	EFDKS70K106E072LH
12	42	30	17	37.5	\	8.0	420	1260	12	28	19.5	35	1	EFDKS70K126E072LH
15	42	32	19	37.5	\	9.5	525	1575	11	28	15.1	35	1	EFDKS70K156E102LH
20	42	40	20	37.5	10.2	12.5	700	2100	9.0	30	10.7	35	1.2	EFDKS70K206E134BH
22	42	40	20	37.5	10.2	13.5	770	2310	8.0	30	10.3	35	1.2	EFDKS70K226E134BH
25	42	40	20	37.5	10.2	15.5	875	2625	7.0	30	8.9	35	1.2	EFDKS70K256E134BH
30	42	44	24	37.5	10.2	16.5	1050	3150	6.5	30	8.5	35	1.2	EFDKS70K306E154BH
35	42	45	30	37.5	20.3	18.5	1225	3675	6.0	30	7.3	35	1.2	EFDKS70K356E164DH
40	42	45	30	37.5	20.3	20.5	1400	4200	5.0	30	7.1	35	1.2	EFDKS70K406E164DH
45	42	50	35	37.5	20.3	23	1575	4725	4.5	30	6.3	35	1.2	EFDKS70K456E174DH
50	42	50	35	37.5	20.3	25	1750	5250	4.0	30	6.0	35	1.2	EFDKS70K506E174DH
60	42	55	40	37.5	20.3	27	2100	6300	3.8	30	5.4	35	1.2	EFDKS70K606E184DH
70	42	55	40	37.5	20.3	29	2450	7350	3.5	30	5.1	35	1.2	EFDKS70K706E184DH
75	42	60	45	37.5	20.3	30	2625	7875	3.0	30	5.6	35	1.2	EFDKS70K756E194DH
80	42	60	45	37.5	20.3	32	2800	8400	2.8	30	5.2	35	1.2	EFDKS70K806E194DH
85	42	60	45	37.5	20.3	34	2975	8925	2.5	30	5.2	35	1.2	EFDKS70K856E194DH
40	57.5	45	25	52.5	10.2	13.5	800	2400	8.0	35	10.3	20	1.2	EFDKS70K406F014BH
45	57.5	45	25	52.5	10.2	14	900	2700	7.5	35	10.2	20	1.2	EFDKS70K456F014BH
50	57.5	45	25	52.5	10.2	15.5	1000	3000	7.0	35	8.9	20	1.2	EFDKS70K506F014BH
55	57.5	45	30	52.5	20.3	17	1100	3300	6.2	35	8.4	20	1.2	EFDKS70K556F024DH
60	57.5	45	30	52.5	20.3	18.5	1200	3600	6.0	35	7.3	20	1.2	EFDKS70K606F024DH

1. Standard part numbers listed--addition configurations available for tolerance, terminal and lead length. See part number system for available tolerances and terminal and lead length tables for available options.

Rating and part number

Rated voltage 700 Vdc

Capacitance value (μF)	Dimensions					I _{rms} +70 °C, 10 kHz (A)	Peak current (A)	Surge current (A)	ESR 10 kHz (mΩ)	ESL (nH)	Thermal resistance (°C/W)	dv/dt (V/μs)	Lead wire diameter (mm)	Part number ¹
	W (mm)	H (mm)	T (mm)	P (mm)	P1 (mm)									
65	57.5	50	35	52.5	20.3	20	1300	3900	5.5	35	6.8	20	1.2	EFDKS70K656F034DH
70	57.5	50	35	52.5	20.3	21.5	1400	4200	5.0	35	6.5	20	1.2	EFDKS70K706F034DH
75	57.5	50	35	52.5	20.3	23.5	1500	4500	4.5	35	6.0	20	1.2	EFDKS70K756F034DH
80	57.5	50	35	52.5	20.3	24.5	1600	4800	4.2	35	5.9	20	1.2	EFDKS70K806F034DH
90	57.5	55	45	52.5	20.3	26	1800	5400	4.0	35	5.5	20	1.2	EFDKS70K906F044DH
100	57.5	55	45	52.5	20.3	29	2000	6000	3.4	35	5.2	20	1.2	EFDKS70K107F044DH
110	57.5	55	45	52.5	20.3	30	2200	6600	3.0	35	5.6	20	1.2	EFDKS70K117F044DH
120	57.5	65	45	52.5	20.3	32	2400	7200	2.8	35	5.2	20	1.2	EFDKS70K127F064DH
130	57.5	65	45	52.5	20.3	33	2600	7800	2.6	35	5.3	20	1.2	EFDKS70K137F064DH
140	57.5	65	45	52.5	20.3	34	2800	8400	2.5	35	5.2	20	1.2	EFDKS70K147F064DH

1. Standard part numbers listed---addition configurations available for tolerance, terminal and lead length. See part number system for available tolerances and terminal and lead length tables for available options.

Rating and part number

Rated voltage 800 Vdc

Capacitance value (μF)	Dimensions					I _{rms} +70 °C, 10 kHz (A)	Peak current (A)	Surge current (A)	ESR 10 kHz (mΩ)	ESL (nH)	Thermal resistance (°C/W)	dv/dt (V/μs)	Lead wire diameter (mm)	Part number ¹
	W (mm)	H (mm)	T (mm)	P (mm)	P1 (mm)									
2	32	18	9	27.5	\	2.9	130	390	40	25	44.6	65	0.8	EFDKS80K205D022LH
3	32	20	11	27.5	\	4.5	195	585	26	25	28.5	65	0.8	EFDKS80K305D032LH
4	32	24.5	13	27.5	\	5.8	260	780	22	25	20.3	65	0.8	EFDKS80K405D062LH
5	32	24.5	15	27.5	\	7.5	325	975	14	25	19.0	65	0.8	EFDKS80K505D072LH
6	32	30	16	27.5	\	8.5	390	1170	12	25	17.3	65	0.8	EFDKS80K605D102LH
7	32	30	16	27.5	\	9.5	455	1365	11	25	15.1	65	0.8	EFDKS80K705D102LH
8	32	33	18	27.5	\	10.5	520	1560	10.5	25	13	65	0.8	EFDKS80K805D122LH
9	32	33	18	27.5	\	11.5	585	1755	10.2	25	11.1	65	0.8	EFDKS80K905D122LH
10	32	37	22	27.5	\	12	650	1950	9.5	25	11	65	0.8	EFDKS80K106D132LH
10	32	37	22	27.5	10.2	14	650	1950	8.5	25	9.0	65	1	EFDKS80K106D134BH
12	32	37	22	27.5	\	12	780	2340	9.5	25	11	65	0.8	EFDKS80K126D132LH
12	32	37	22	27.5	10.2	15	780	2340	8.0	25	8.3	65	1	EFDKS80K126D134BH
14	32	37	22	27.5	\	12	910	2730	9.5	25	11	65	0.8	EFDKS80K146D132LH
14	32	37	22	27.5	10.2	16	910	2730	7.5	25	7.8	65	1	EFDKS80K146D134BH
8	42	30	17	37.5	\	5.5	280	840	22.5	28	22	35	1	EFDKS80K805E072LH
9	42	30	17	37.5	\	6.0	315	945	21.5	28	19.4	35	1	EFDKS80K905E072LH
10	42	32	19	37.5	\	7.0	350	1050	18	28	17	35	1	EFDKS80K106E102LH
12	42	32	19	37.5	\	8.0	420	1260	12	28	19.5	35	1	EFDKS80K126E102LH
14	42	32	19	37.5	\	9.5	490	1470	11	28	15.1	35	1	EFDKS80K146E102LH
15	42	40	20	37.5	10.2	12.5	525	1575	9.0	30	10.7	35	1.2	EFDKS80K156E134BH
20	42	44	24	37.5	10.2	13.5	700	2100	8.0	30	10.3	35	1.2	EFDKS80K206E154BH
25	42	44	24	37.5	10.2	16.5	875	2625	6.5	30	8.5	35	1.2	EFDKS80K256E154BH
30	42	45	30	37.5	20.3	20	1050	3150	5.8	30	6.5	35	1.2	EFDKS80K306E164DH
35	42	50	35	37.5	20.3	22	1225	3675	5.5	30	5.6	35	1.2	EFDKS80K356E174DH
40	42	50	35	37.5	20.3	25	1400	4200	4.8	30	5.0	35	1.2	EFDKS80K406E174DH
45	42	55	40	37.5	20.3	28	1575	4725	4.0	30	4.8	35	1.2	EFDKS80K456E184DH
50	42	55	40	37.5	20.3	31	1750	5250	3.6	30	4.3	35	1.2	EFDKS80K506E184DH
55	42	60	45	37.5	20.3	32.5	1925	5775	3.4	30	4.2	35	1.2	EFDKS80K556E194DH
60	42	60	45	37.5	20.3	34	2100	6300	3.2	30	4.1	35	1.2	EFDKS80K606E194DH
65	42	60	45	37.5	20.3	35	2275	6825	2.8	30	4.4	35	1.2	EFDKS80K656E194DH
25	57.5	45	25	52.5	10.2	8.5	500	1500	12	35	17.3	20	1.2	EFDKS80K256F014BH
30	57.5	45	25	52.5	10.2	10	600	1800	10.5	35	14.3	20	1.2	EFDKS80K306F014BH
35	57.5	45	25	52.5	10.2	12	700	2100	9.5	35	11	20	1.2	EFDKS80K356F014BH
40	57.5	45	30	52.5	20.3	14	800	2400	8.5	35	9.0	20	1.2	EFDKS80K406F024DH
45	57.5	45	30	52.5	20.3	15.5	900	2700	7.0	35	8.9	20	1.2	EFDKS80K456F024DH

1. Standard part numbers listed--addition configurations available for tolerance, terminal and lead length. See part number system for available tolerances and terminal and lead length tables for available options.

Rating and part number

Rated voltage 800 Vdc

Capacitance value (μF)	Dimensions					I _{rms} +70 °C, 10 kHz (A)	Peak current (A)	Surge current (A)	ESR 10 kHz (mΩ)	ESL (nH)	Thermal resistance (°C/W)	dv/dt (V/μs)	Lead wire diameter (mm)	Part number ¹
	W (mm)	H (mm)	T (mm)	P (mm)	P1 (mm)									
50	57.5	50	35	52.5	20.3	17	1000	3000	5.8	35	8.9	20	1.2	EFDKS80K506F034DH
55	57.5	50	35	52.5	20.3	19	1100	3300	5.5	35	7.6	20	1.2	EFDKS80K556F034DH
60	57.5	50	35	52.5	20.3	21	1200	3600	4.8	35	7.1	20	1.2	EFDKS80K606F034DH
65	57.5	55	45	52.5	20.3	22.5	1300	3900	4.6	35	6.4	20	1.2	EFDKS80K656F044DH
70	57.5	55	45	52.5	20.3	24	1400	4200	4.5	35	5.8	20	1.2	EFDKS80K706F044DH
75	57.5	55	45	52.5	20.3	25.5	1500	4500	4.3	35	5.4	20	1.2	EFDKS80K756F044DH
80	57.5	55	45	52.5	20.3	26	1600	4800	4.2	35	5.3	20	1.2	EFDKS80K806F044DH
90	57.5	55	45	52.5	20.3	27.5	1800	5400	4.0	35	5.0	20	1.2	EFDKS80K906F044DH
100	57.5	65	45	52.5	20.3	31.5	2000	6000	3.2	35	4.7	20	1.2	EFDKS80K107F064DH
110	57.5	65	45	52.5	20.3	34	2200	6600	3.0	35	4.3	20	1.2	EFDKS80K117F064DH

1. Standard part numbers listed--additional configurations available for tolerance, terminal and lead length. See part number system for available tolerances and terminal and lead length tables for available options.

Rating and part number

Rated voltage 900 Vdc

Capacitance value (μF)	Dimensions					I _{rms} +70 °C, 10 kHz (A)	Peak current (A)	Surge current (A)	ESR 10 kHz (mΩ)	ESL (nH)	Thermal resistance (°C/W)	dv/dt (V/μs)	Lead wire diameter (mm)	Part number ¹
	W (mm)	H (mm)	T (mm)	P (mm)	P1 (mm)									
1	32	18	9	27.5	\	2.0	70	210	65.0	25	57.7	70	0.8	EFDKS90K105D022LH
2	32	20	11	27.5	\	3.2	140	420	38	25	38.5	70	0.8	EFDKS90K205D032LH
3	32	22	13	27.5	\	4.8	210	630	30	25	21.7	70	0.8	EFDKS90K305D042LH
4	32	24.5	15	27.5	\	6.0	280	840	20.5	25	20.3	70	0.8	EFDKS90K405D072LH
5	32	30	16	27.5	\	7.5	350	1050	12	25	22.2	70	0.8	EFDKS90K505D102LH
6	32	33	18	27.5	\	7.8	420	1260	11.5	25	21.4	70	0.8	EFDKS90K605D122LH
7	32	33	18	27.5	\	10.5	490	1470	10.2	25	13.3	70	0.8	EFDKS90K705D122LH
8	32	37	22	27.5	\	11.5	560	1680	9.5	25	11.9	70	0.8	EFDKS90K805D132LH
8	32	37	22	27.5	10.2	12.5	560	1680	9.0	25	10.7	70	1	EFDKS90K805D134BH
9	32	37	22	27.5	\	11.8	630	1890	9.7	25	11.1	70	0.8	EFDKS90K905D132LH
9	32	37	22	27.5	10.2	14.0	630	1890	7.8	25	9.8	70	1	EFDKS90K905D134BH
10	32	37	22	27.5	\	12.0	700	2100	9.5	25	11	70	0.8	EFDKS90K106D132LH
10	32	37	22	27.5	10.2	15.5	700	2100	7.2	25	8.7	70	1	EFDKS90K106D134BH
5	42	30	17	37.5	\	3.8	175	525	28	28	37.1	35	1	EFDKS90K505E072LH
6	42	30	17	37.5	\	4.5	210	630	25	28	29.6	35	1	EFDKS90K605E072LH
7	42	30	17	37.5	\	5.0	245	735	22	28	27.3	35	1	EFDKS90K705E072LH
8	42	32	19	37.5	\	6.0	280	840	19.5	28	21.4	35	1	EFDKS90K805E102LH
10	42	40	20	37.5	10.2	7.5	350	1050	13	30	20.5	35	1.2	EFDKS90K106E134BH
12	42	37	22	37.5	10.2	9.0	420	1260	11.5	30	16.1	35	1.2	EFDKS90K126E114BH
15	42	44	24	37.5	10.2	10.5	525	1575	10.5	30	13	35	1.2	EFDKS90K156E154BH
18	42	44	24	37.5	10.2	13	630	1890	8.8	30	10.1	35	1.2	EFDKS90K186E154BH
20	42	44	24	37.5	10.2	14.5	700	2100	7.5	30	9.5	35	1.2	EFDKS90K206E154BH
25	42	45	30	37.5	20.3	17.5	875	2625	6.2	30	7.9	35	1.2	EFDKS90K256E164DH
30	42	50	35	37.5	20.3	21.5	1050	3150	5.0	30	6.5	35	1.2	EFDKS90K306E174DH
35	42	55	40	37.5	20.3	23	1225	3675	4.6	30	6.2	35	1.2	EFDKS90K356E184DH
40	42	55	40	37.5	20.3	26.5	1400	4200	3.9	30	5.5	35	1.2	EFDKS90K406E184DH
45	42	60	45	37.5	20.3	30	1575	4725	3.4	30	4.9	35	1.2	EFDKS90K456E194DH
50	42	60	45	37.5	20.3	33.5	1750	5250	3.0	30	4.5	35	1.2	EFDKS90K506E194DH
15	57.5	45	25	52.5	10.2	5.5	300	900	22	35	22.5	20	1.2	EFDKS90K156F014BH
20	57.5	45	25	52.5	10.2	7.5	400	1200	13.5	35	19.8	20	1.2	EFDKS90K206F014BH
25	57.5	45	25	52.5	10.2	9.0	500	1500	11.5	35	16.1	20	1.2	EFDKS90K256F014BH
30	57.5	45	30	52.5	20.3	11	600	1800	10	35	12.4	20	1.2	EFDKS90K306F024DH
35	57.5	45	30	52.5	20.3	12.5	700	2100	9.0	35	10.7	20	1.2	EFDKS90K356F024DH
40	57.5	50	35	52.5	20.3	14.5	800	2400	7.5	35	9.5	20	1.2	EFDKS90K406F034DH
45	57.5	50	35	52.5	20.3	16	900	2700	6.8	35	8.6	20	1.2	EFDKS90K456F034DH
50	57.5	50	35	52.5	20.3	18	1000	3000	6.4	35	7.2	20	1.2	EFDKS90K506F034DH

1. Standard part numbers listed---addition configurations available for tolerance, terminal and lead length. See part number system for available tolerances and terminal and lead length tables for available options.

Rating and part number

Rated voltage 900 Vdc

Capacitance value (μF)	Dimensions					I _{rms} +70 °C, 10 kHz (A)	Peak current (A)	Surge current (A)	ESR 10 kHz (mΩ)	ESL (nH)	Thermal resistance (°C/W)	dv/dt (V/μs)	Lead wire diameter (mm)	Part number ¹
	W (mm)	H (mm)	T (mm)	P (mm)	P1 (mm)									
55	57.5	55	45	52.5	20.3	20	1100	3300	5.6	35	6.7	20	1.2	EFDKS90K556F044DH
60	57.5	55	45	52.5	20.3	21.5	1200	3600	4.8	35	6.8	20	1.2	EFDKS90K606F044DH
65	57.5	55	45	52.5	20.3	23.0	1300	3900	4.5	35	6.3	20	1.2	EFDKS90K656F044DH
70	57.5	65	45	52.5	20.3	25.0	1400	4200	4.0	35	6.0	20	1.2	EFDKS90K706F064DH
75	57.5	65	45	52.5	20.3	25.5	1500	4500	3.9	35	5.9	20	1.2	EFDKS90K756F064DH
80	57.5	65	45	52.5	20.3	26.5	1600	4800	3.8	35	5.6	20	1.2	EFDKS90K806F064DH
85	57.5	65	45	52.5	20.3	28.5	1700	5100	3.6	35	5.1	20	1.2	EFDKS90K856F064DH

1. Standard part numbers listed---addition configurations available for tolerance, terminal and lead length. See part number system for available tolerances and terminal and lead length tables for available options.

Rating and part number

Rated voltage 1000 Vdc

Capacitance value (μF)	Dimensions					I _{rms} +70 °C, 10 kHz (A)	Peak current (A)	Surge current (A)	ESR 10 kHz (mΩ)	ESL (nH)	Thermal resistance (°C/W)	dv/dt (V/μs)	Lead wire diameter (mm)	Part number ¹
	W (mm)	H (mm)	T (mm)	P (mm)	P1 (mm)									
1	32	18	9	27.5	\	2.0	75	225	65	25	57.7	75	0.8	EFDKS1AK105D022LH
2	32	22	13	27.5	\	3.5	150	450	38	25	32.2	75	0.8	EFDKS1AK205D042LH
3	32	24.5	15	27.5	\	5.0	225	675	22	25	27.3	75	0.8	EFDKS1AK305D072LH
4	32	30	16	27.5	\	7.0	300	900	16.5	25	18.6	75	0.8	EFDKS1AK405D102LH
5	32	33	18	27.5	\	8.5	375	1125	12.5	25	16.6	75	0.8	EFDKS1AK505D122LH
6	32	33	18	27.5	\	9.0	450	1350	11.5	25	16.1	75	0.8	EFDKS1AK605D122LH
7	32	37	22	27.5	\	9.5	525	1575	11	25	15.1	75	0.8	EFDKS1AK705D132LH
7	32	37	22	27.5	10.2	11.5	525	1575	9.8	25	11.6	75	1	EFDKS1AK705D134BH
8	32	37	22	27.5	\	10.5	600	1800	10.5	25	13.0	75	0.8	EFDKS1AK805D132LH
8	32	37	22	27.5	10.2	13	600	1800	8.8	25	10.1	75	1	EFDKS1AK805D134BH
5	42	30	17	37.5	\	3.8	175	525	28	28	37.1	35	1	EFDKS1AK505E072LH
6	42	30	17	37.5	\	4.5	210	630	25	28	29.6	35	1	EFDKS1AK605E072LH
7	42	30	17	37.5	\	5.0	245	735	22	28	27.3	35	1	EFDKS1AK705E072LH
8	42	32	19	37.5	\	6.0	280	840	19.5	28	21.4	35	1	EFDKS1AK805E102LH
10	42	40	20	37.5	10.2	7.5	350	1050	13.0	30	20.5	35	1.2	EFDKS1AK106E134BH
12	42	37	22	37.5	10.2	9.0	420	1260	11.5	30	16.1	35	1.2	EFDKS1AK126E114BH
15	42	44	24	37.5	10.2	11.5	525	1575	10	30	11.3	35	1.2	EFDKS1AK156E154BH
18	42	45	30	37.5	20.3	14	630	1890	7.8	30	9.8	35	1.2	EFDKS1AK186E164DH
20	42	45	30	37.5	20.3	15.5	700	2100	7.0	30	8.9	35	1.2	EFDKS1AK206E164DH
25	42	50	35	37.5	20.3	19.5	875	2625	5.5	30	7.2	35	1.2	EFDKS1AK256E174DH
30	42	55	40	37.5	20.3	23	1050	3150	4.6	30	6.2	35	1.2	EFDKS1AK306E184DH
35	42	55	40	37.5	20.3	25	1225	3675	4.0	30	6.0	35	1.2	EFDKS1AK356E184DH
40	42	60	45	37.5	20.3	28.5	1400	4200	3.6	30	5.1	35	1.2	EFDKS1AK406E194DH
15	57.5	45	25	52.5	10.2	5.8	300	900	19.8	35	22.5	20	1.2	EFDKS1AK156F014BH
20	57.5	45	25	52.5	10.2	7.5	400	1200	13.5	35	19.8	20	1.2	EFDKS1AK206F014BH
25	57.5	45	25	52.5	10.2	9.5	500	1500	11	35	15.1	20	1.2	EFDKS1AK256F014BH
30	57.5	45	30	52.5	20.3	11.5	600	1800	9.8	35	11.6	20	1.2	EFDKS1AK306F024DH
35	57.5	45	30	52.5	20.3	13.5	700	2100	8.0	35	10.3	20	1.2	EFDKS1AK356F024DH
40	57.5	50	35	52.5	20.3	15.5	800	2400	7.0	35	8.9	20	1.2	EFDKS1AK406F034DH
45	57.5	55	45	52.5	20.3	17.5	900	2700	6.2	35	7.9	20	1.2	EFDKS1AK456F044DH
50	57.5	55	45	52.5	20.3	19.5	1000	3000	5.8	35	6.8	20	1.2	EFDKS1AK506F044DH
55	57.5	55	45	52.5	20.3	21	1100	3300	5.0	35	6.8	20	1.2	EFDKS1AK556F044DH
60	57.5	65	45	52.5	20.3	23	1200	3600	4.6	35	6.2	20	1.2	EFDKS1AK606F064DH
65	57.5	65	45	52.5	20.3	25	1300	3900	4.2	35	5.7	20	1.2	EFDKS1AK656F064DH
70	57.5	65	45	52.5	20.3	27	1400	4200	3.8	35	5.4	20	1.2	EFDKS1AK706F064DH

1. Standard part numbers listed--addition configurations available for tolerance, terminal and lead length. See part number system for available tolerances and terminal and lead length tables for available options.

Rating and part number

Rated voltage 1100 Vdc

Capacitance value (μF)	Dimensions					I _{rms} +70 °C, 10 kHz (A)	Peak current (A)	Surge current (A)	ESR 10 kHz (mΩ)	ESL (nH)	Thermal resistance (°C/W)	dv/dt (V/μs)	Lead wire diameter (mm)	Part number ¹
	W (mm)	H (mm)	T (mm)	P (mm)	P1 (mm)									
1	32	20	11	27.5	\	2.2	80	240	65	25	47.7	80	0.8	EFDKS1BK105D032LH
1.5	32	22	13	27.5	\	2.5	120	360	46	25	52.2	80	0.8	EFDKS1BK155D042LH
2	32	24.5	13	27.5	\	4.8	160	480	24.5	25	26.6	80	0.8	EFDKS1BK205D062LH
3	32	30	16	27.5	\	6.5	240	720	18.5	25	19.2	80	0.8	EFDKS1BK305D102LH
4	32	33	18	27.5	\	8.5	320	960	12.5	25	16.6	80	0.8	EFDKS1BK405D122LH
5	32	37	22	27.5	\	9.8	400	1200	10.8	25	14.5	80	0.8	EFDKS1BK505D132LH
5	32	37	22	27.5	10.2	10.5	400	1200	10.5	25	13.0	80	1	EFDKS1BK505D134BH
6	32	37	22	27.5	\	10.5	480	1440	10.5	25	13.0	80	0.8	EFDKS1BK605D132LH
6	32	37	22	27.5	10.2	13	480	1440	8.8	25	10.1	80	1	EFDKS1BK605D134BH
3	42	30	17	37.5	\	2.5	120	360	46	28	52.2	40	1	EFDKS1BK305E072LH
4	42	30	17	37.5	\	3.5	160	480	32.5	28	37.7	40	1	EFDKS1BK405E072LH
4.7	42	32	19	37.5	\	4.0	188	564	28	28	33.5	40	1	EFDKS1BK475E102LH
5	42	32	19	37.5	\	4.2	200	600	26	28	32.7	40	1	EFDKS1BK505E102LH
6	42	32	19	37.5	\	5.0	240	720	23.5	28	25.5	40	1	EFDKS1BK605E102LH
7	42	40	20	37.5	10.2	6.0	280	840	18.5	30	22.5	40	1.2	EFDKS1BK705E134BH
8	42	37	22	37.5	10.2	6.5	320	960	16.5	30	21.5	40	1.2	EFDKS1BK805E114BH
9	42	37	22	37.5	10.2	7.5	360	1080	13	30	20.5	40	1.2	EFDKS1BK905E114BH
10	42	44	24	37.5	10.2	8.5	400	1200	12	30	17.3	40	1.2	EFDKS1BK106E154BH
12	42	44	24	37.5	10.2	10	480	1440	10.8	30	13.9	40	1.2	EFDKS1BK126E154BH
14	42	45	30	37.5	20.3	12	560	1680	9.5	30	11.0	40	1.2	EFDKS1BK146E164DH
15	42	45	30	37.5	20.3	13	600	1800	8.5	30	10.4	40	1.2	EFDKS1BK156E164DH
18	42	50	35	37.5	20.3	15	720	2160	7.0	30	9.5	40	1.2	EFDKS1BK186E174DH
20	42	50	35	37.5	20.3	16.5	800	2400	6.5	30	8.5	40	1.2	EFDKS1BK206E174DH
25	42	55	40	37.5	20.3	20.5	1000	3000	5.0	30	7.1	40	1.2	EFDKS1BK256E184DH
30	42	60	45	37.5	20.3	24.5	1200	3600	4.3	30	5.8	40	1.2	EFDKS1BK306E194DH
15	57.5	45	25	52.5	10.2	6.5	300	900	16.5	35	21.5	20	1.2	EFDKS1BK156F014BH
20	57.5	45	30	52.5	20.3	9.0	400	1200	11.5	35	16.1	20	1.2	EFDKS1BK206F024DH
25	57.5	50	35	52.5	20.3	11	500	1500	10	35	12.4	20	1.2	EFDKS1BK256F034DH
30	57.5	50	35	52.5	20.3	13	600	1800	8.6	35	10.3	20	1.2	EFDKS1BK306F034DH
35	57.5	55	45	52.5	20.3	14.5	700	2100	7.5	35	9.5	20	1.2	EFDKS1BK356F044DH
40	57.5	55	45	52.5	20.3	16	800	2400	6.8	35	8.6	20	1.2	EFDKS1BK406F044DH
45	57.5	55	45	52.5	20.3	17.5	900	2700	6.2	35	7.9	20	1.2	EFDKS1BK456F044DH
50	57.5	65	45	52.5	20.3	19.5	1000	3000	5.6	35	7.0	20	1.2	EFDKS1BK506F064DH
55	57.5	65	45	52.5	20.3	21.5	1100	3300	4.8	35	6.8	20	1.2	EFDKS1BK556F064DH

1. Standard part numbers listed--addition configurations available for tolerance, terminal and lead length. See part number system for available tolerances and terminal and lead length tables for available options.

Rating and part number

Rated voltage 1200 Vdc

Capacitance value (μF)	Dimensions					I _{rms} +70 °C, 10 kHz (A)	Peak current (A)	Surge current (A)	ESR 10 kHz (mΩ)	ESL (nH)	Thermal resistance (°C/W)	dv/dt (V/μs)	Lead wire diameter (mm)	Part number ¹
	W (mm)	H (mm)	T (mm)	P (mm)	P1 (mm)									
1	32	20	11	27.5	\	3.5	90	270	35	25	35	90	0.8	EFDKS1CK105D032LH
2	32	24.5	15	27.5	\	5.0	180	540	24	25	25	90	0.8	EFDKS1CK205D072LH
3	32	30	16	27.5	\	7.5	270	810	13	25	20.5	90	0.8	EFDKS1CK305D102LH
4	32	33	18	27.5	\	9.5	360	1080	11	25	15.1	90	0.8	EFDKS1CK405D122LH
5	32	37	22	27.5	\	10.5	450	1350	10.5	25	13	90	0.8	EFDKS1CK505D132LH
5	32	37	22	27.5	10.2	12	450	1350	9.5	25	11	90	1	EFDKS1CK505D134BH
3	42	30	17	37.5	\	3.2	135	405	35	28	41.9	45	1	EFDKS1CK305E072LH
4	42	30	17	37.5	\	4.2	180	540	28	28	30.4	45	1	EFDKS1CK405E072LH
5	42	32	19	37.5	\	5.5	225	675	21.5	28	23.1	45	1	EFDKS1CK505E102LH
6	42	40	20	37.5	10.2	6.5	270	810	16.5	30	21.5	45	1.2	EFDKS1CK605E134BH
7	42	37	22	37.5	10.2	7.5	315	945	13	30	20.5	45	1.2	EFDKS1CK705E114BH
8	42	44	24	37.5	10.2	8.5	360	1080	12	30	17.3	45	1.2	EFDKS1CK805E154BH
9	42	44	24	37.5	10.2	10	405	1215	10.8	30	13.9	45	1.2	EFDKS1CK905E154BH
10	42	44	24	37.5	10.2	11	450	1350	10	30	12.4	45	1.2	EFDKS1CK106E154BH
12	42	45	30	37.5	20.3	13	540	1620	8.5	30	10.4	45	1.2	EFDKS1CK126E164DH
15	42	50	35	37.5	20.3	16	675	2025	6.8	30	8.6	45	1.2	EFDKS1CK156E174DH
18	42	50	35	37.5	20.3	18	810	2430	6.2	30	7.5	45	1.2	EFDKS1CK186E174DH
20	42	55	40	37.5	20.3	20	900	2700	5.5	30	6.8	45	1.2	EFDKS1CK206E184DH
25	42	60	45	37.5	20.3	25	1125	3375	4.3	30	5.6	45	1.2	EFDKS1CK256E194DH
12	57.5	45	25	52.5	10.2	6.5	300	900	16.5	35	21.5	25	1.2	EFDKS1CK126F014BH
15	57.5	45	25	52.5	10.2	7.5	375	1125	13	35	20.5	25	1.2	EFDKS1CK156F014BH
20	57.5	45	30	52.5	20.3	11	500	1500	10	35	12.4	25	1.2	EFDKS1CK206F024DH
25	57.5	50	35	52.5	20.3	13	625	1875	8.6	35	10.3	25	1.2	EFDKS1CK256F034DH
30	57.5	55	45	52.5	20.3	14.5	750	2250	7.5	35	9.5	25	1.2	EFDKS1CK306F044DH
35	57.5	55	45	52.5	20.3	16	875	2625	6.8	35	8.6	25	1.2	EFDKS1CK356F044DH
40	57.5	65	45	52.5	20.3	20	1000	3000	5.5	35	6.8	25	1.2	EFDKS1CK406F064DH
45	57.5	65	45	52.5	20.3	22.5	1125	3375	4.8	35	6.2	25	1.2	EFDKS1CK456F064DH

1. Standard part numbers listed---addition configurations available for tolerance, terminal and lead length. See part number system for available tolerances and terminal and lead length tables for available options.

General information

Application	DC Link / DC Filtering
Dielectric	Metallized Polypropylene Film
Reference standard	IEC 61071/EN 61071
Climatic category	40/105/56 IEC60068-1
Operating temperature range	-40 °C to +105 °C, (derate working voltage [U_R] by 1.25% for +85 °C to +105 °C)
Protection	Solvent resistant plastic case UL94 V-0, Thermosetting resin sealing UL 94V-0 compliant
Installation	Any position
Packaging	Packed in cardboard boxes with protection for the terminals
Storage conditions	Storage time: <24 months from the date marked on the package label, Average relative humidity per year <70%, RH<85% for 30 days in one year, Dew is absent, Temperature: -40 °C to +85 °C
RoHS compliant	Compliant with the restricted substance requirements of Directive 2011/65/EU
Flame retardant grade	Flame retardant performance accords with horizontal combustion grade HB and vertical combustion grade V-0
Application note and limiting conditions	These capacitors are designed only for DC voltage so should not be used for AC line. The continuous peak voltage shall not exceed the rated DC voltage rating

Construction

Metallized film	OPP & Al/Zn
Metal sprayed	Sn/Zn Alloy
Connection electrode	Tinned copper wires
Plastic case	Plastic Case (UL94V-0)
Filling	Epoxy Resin (UL94V-0)

Film construction

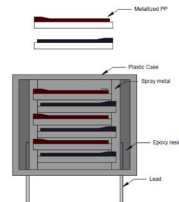

Electrical and general characteristics

Voltage range (U_R)	450 Vdc to 1200 Vdc
Capacitance range	1.0 μ F to 200 μ F
Capacitance tolerance	\pm 5% or \pm 10% at +20 °C
Capacitance	Measuring frequency at 1 kHz, +20 °C Measuring voltage: 1.0 \pm 0.2 V
Standard atmospheric conditions for static test	Ambient temperature +15 °C to +35 °C. Relative humidity 45% to 75% Air pressure 86 kPa to 106 kPa.
Withstanding DC voltage between terminals U_{TT}	1.5 x U_R for 10 seconds (between terminations) @ +20 °C \pm 5 °C
Withstanding AC voltage between terminal and case U_{TC}	3000 Vac, 50/60 Hz 60 s (at +20 \pm 5 °C)
Dissipation factor	\leq 20 x 10 ⁻⁴ at 1 kHz; C \leq 20 μ F at +20 °C \leq 30 x 10 ⁻⁴ at 1 kHz; 20 μ F < C \leq 80 μ F at +20 °C \leq 40 x 10 ⁻⁴ at 1 kHz; C >80 μ F at +20 °C
Insulation resistance	RC between leads, at 100 V +20 °C; 1 minute > 30,000 M Ω * μ F
Self-inductance	<1 nH per mm of lead spacing
Life expectancy	100,000 hours (U_R hotspot = +85 °C) (Δ C/C \leq 5%)
Failure rate	100 Fit
Maximum altitude	2000 m
Overtolerance	Maximum duration within one day: Apply 110% of rated voltage 30% of on-load duration Apply 115% of rated voltage 30 minutes Apply 120% of rated voltage 5 minutes Apply 130% of rated voltage 1 minute

Characteristics curves

Expected life curve

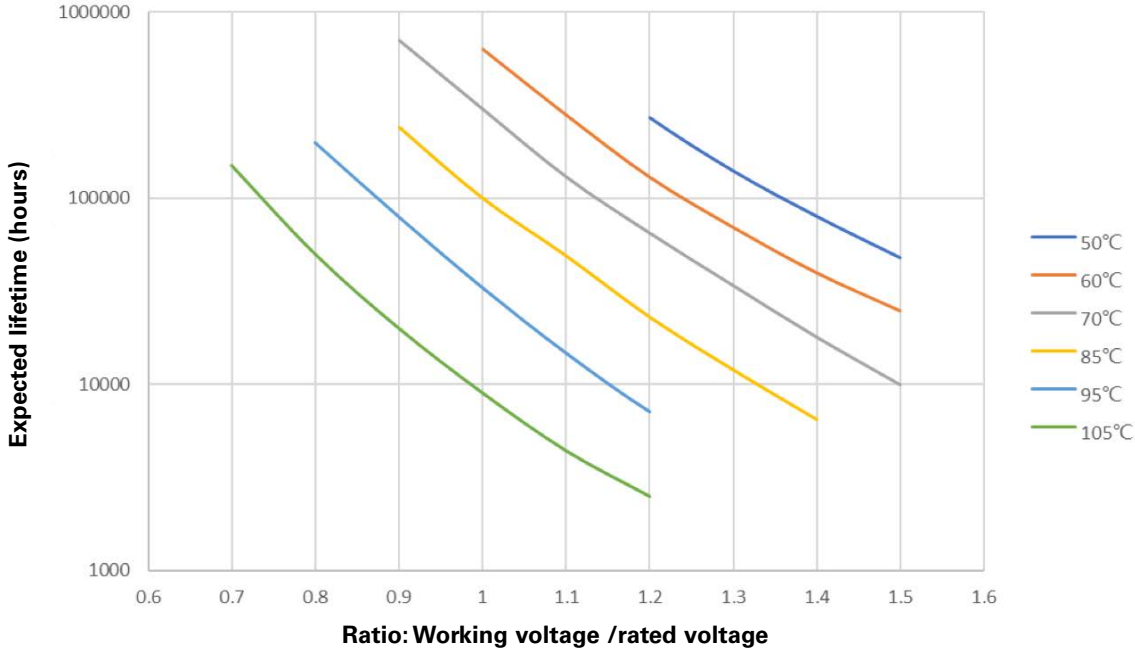

Derating of U_R vs temperature

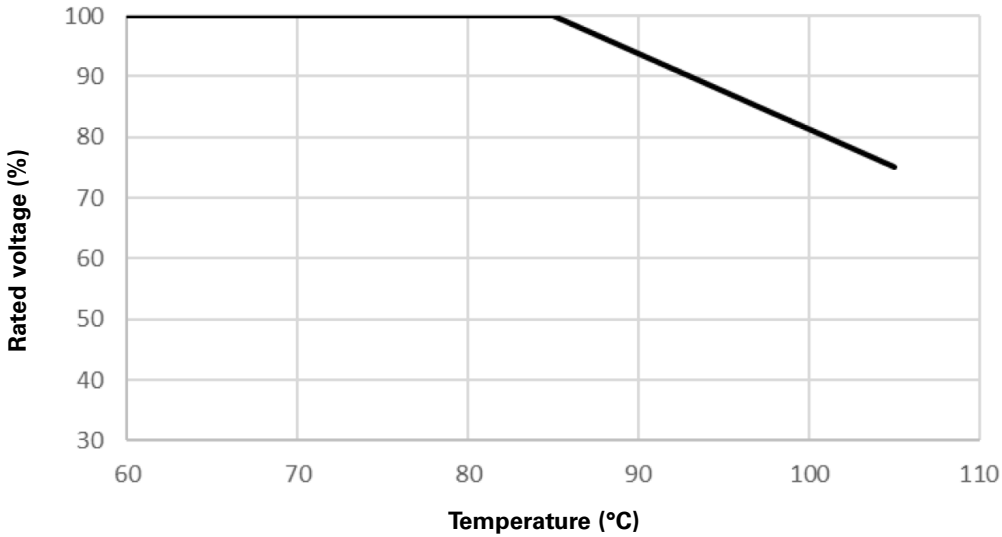

Characteristics curves

Derating of I_{rms} vs temperature

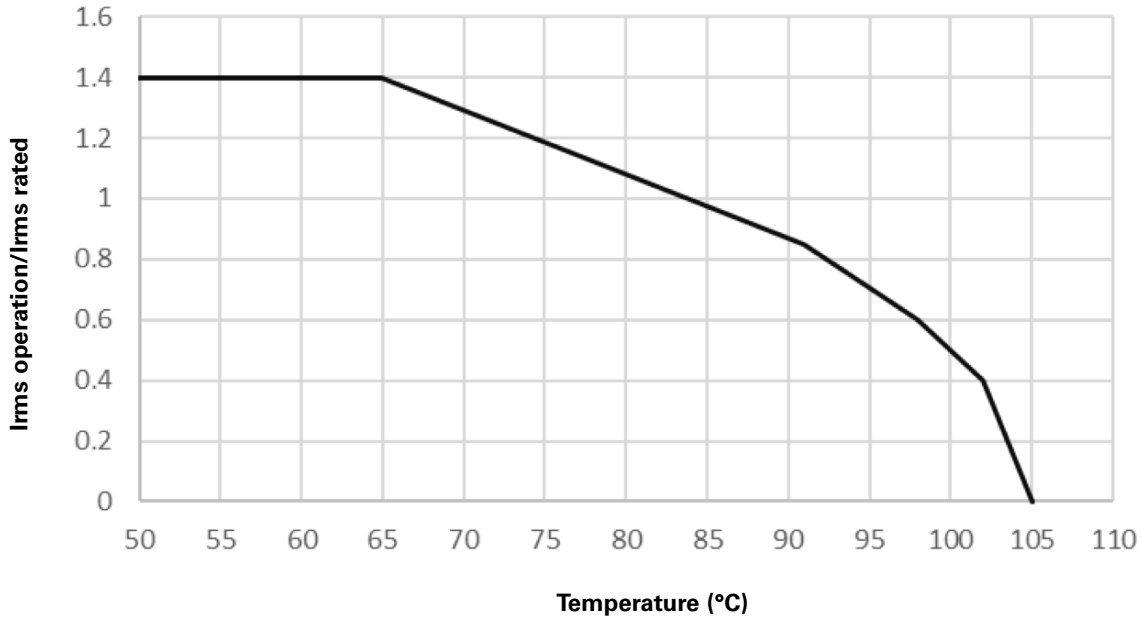

Impedance vs frequency

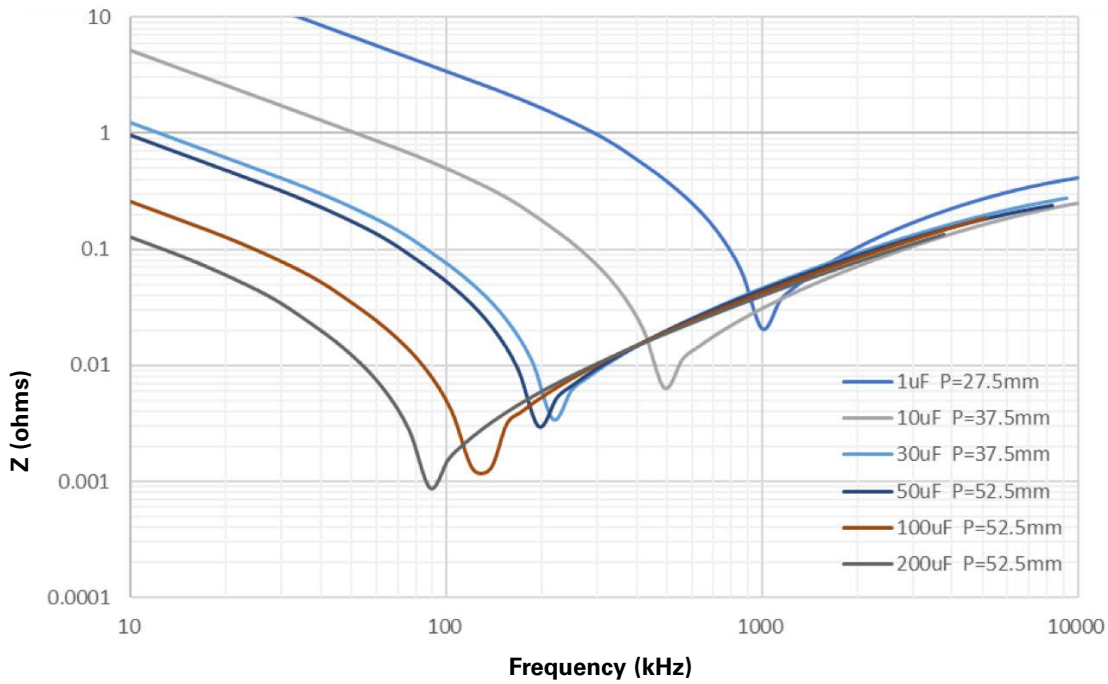

Environmental test

Test	Test condition	Performance
Rapid temperature change	Test temperature cycle: Total 5 cycles High temperature: +105 ±5 °C for 30 minutes Low temperature: -40 ±5 °C for 30 minutes	Capacitance change rate ($\Delta C/C$): ≤±2% DF change ($\Delta tg \delta$): ≤50*10 ⁻⁴ at 1 kHz Insulation resistance: ≥50% of initial limit (T-T) test voltage: 1.5 x U _R /10 s (T-C) test voltage: 3000 Vac/60 s ESR change rate ($\Delta ESR / ESR$): ≤±300%
High temperature loading	Testing method per IEC 61071. Test temperature: +85 ±2 °C. Apply 130% of rated voltage for 1,000 +24/-0 hours. Test temperature: +105 ±2 °C. Apply 130% * 75% of rated voltage for 1,000 +24/-0 hours. Duration: 500 hours,1000 charges and discharges At 1.4 x I peak (maximum respective peak current in continuous operation)	Capacitance change rate ($\Delta C/C$): ≤±5% DF change ($\Delta tg \delta$): ≤50*10 ⁻⁴ at 1 kHz Insulation resistance: ≥50% of initial limit (T-T) test voltage: 1.5 x U _R /10 s (T-C) test voltage: 3000 Vac/60 s ESR change rate ($\Delta ESR / ESR$): ≤±300%
High temperature features	Test Temperature: +105 ±2 °C Test Duration: 16 +1/-0 hours	Capacitance change rate ($\Delta C/C$): -0 to -5% DF change ($\Delta tg \delta$): ≤50*10 ⁻⁴ at 1 kHz Insulation resistance: ≥50% of initial limit (T-T) test voltage: 1.5 x U _R /10 s (T-C) test voltage: 3000 Vac/60 s ESR change rate ($\Delta ESR / ESR$): ≤±300%
Low temperature features	Test Temperature: -40 ±2 °C Test Duration: 2 +1/-0 hrs.	Capacitance change rate ($\Delta C/C$): +0 to +5% DF change ($\Delta tg \delta$): ≤50*10 ⁻⁴ at 1 kHz Insulation resistance: ≥50% of initial limit (T-T) test voltage: 1.5 x U _R /10 s (T-C) test voltage: 3000 Vac/60 s ESR change rate ($\Delta ESR / ESR$): ≤±300%
Solderability	Testing method per IEC 60068-2-20 Ta Soldering temperature: +245 ±5 °C Immersion duration: 2 +/-0.5 seconds	More than 95% of circumferential surface of lead wire shall be covered with new solder. Insulation Resistance: ≥50% of initial limit (T-T) test voltage: 1.5 x U _R /10 s (T-C) test voltage: 3000 Vac/60 s
Soldering heat resistance	Flow soldering: Preheat temperature +100 °C to +120 °C Preheat Duration: 100 seconds maximum Soldering Temperature: +260 ±5 °C Immersion Duration: ≤10 seconds Immersion Depth: 1.5 +/- 0.5 mm from roots.	Capacitance change rate ($\Delta C/C$): ≤±0.5% DF change ($\Delta tg \delta$): ≤50*10 ⁻⁴ at 1 kHz Insulation resistance: ≥50% of initial limit (T-T) test voltage: 1.5 x U _R /10 s (T-C) test voltage: 3000 Vac/60 s ESR change rate ($\Delta ESR / ESR$): ≤±300%
Humidity resistance	Testing method per IEC 60068-2-3 Ca Test Temperature: +40 +/-2°C Test Humidity: 90% to 95% R.H. Test Duration: 1344 +24/-0 hours	Capacitance change rate ($\Delta C/C$): ≤±5% DF change ($\Delta tg \delta$): ≤50*10 ⁻⁴ at 1 kHz Insulation resistance: ≥50% of initial limit (T-T) test voltage: 1.5 x U _R /10 s (T-C) test voltage: 3000 Vac/60 s ESR change rate ($\Delta ESR / ESR$): ≤±300%

Electrical test

Test	Test condition	Performance
Self-healing test	Apply 150% of rated voltage Duration: 10 seconds Number of clearings ≤ 5 Clearing = voltage drop of 5 % increase the voltage at 100 V/s till 5 clearings occur with a maximum of $2.5 \times U_{NDC}$ for a duration of 10 seconds	Capacitance change rate ($\Delta C/C$): $\leq \pm 0.5\%$ DF change ($\Delta tg \delta$): $\leq 50 \times 10^{-4}$ at 1 kHz Insulation resistance: $\geq 50\%$ of initial limit (T-T) test voltage: $1.5 \times U_R/10$ s (T-C) test voltage: 3000 Vac/60 s ESR change rate ($\Delta ESR / ESR$): $\leq \pm 300\%$
Surge discharge test	Five charges and discharges in ten minutes. Test voltage: 1.1 U Test current: 1.1 times the maximum impulse current The interelectrode withstand voltage was tested within five minutes after the test.	Capacitance change rate ($\Delta C/C$): $\leq \pm 1.0\%$ DF change ($\Delta tg \delta$): $\leq 50 \times 10^{-4}$ at 1 kHz Insulation resistance: $\geq 50\%$ of initial limit (T-T) test voltage: $1.5 \times U_R/10$ s (T-C) test voltage: 3000 Vac/60 s ESR change rate ($\Delta ESR / ESR$): $\leq \pm 300\%$
Thermal stability	Temperature: ambient temperature Test current: 1.1 Irms Test frequency: 10 kHz Test time: 48 h During, the last 6h, the temperature of the case near of the top rise shall be measured per 1.5 h.	Capacitance change rate ($\Delta C/C$): $\leq \pm 2.0\%$ DF change ($\Delta tg \delta$): $\leq 50 \times 10^{-4}$ at 1 kHz Insulation resistance: $\geq 50\%$ of initial limit (T-T) test voltage: $1.5 \times U_R/10$ s (T-C) test voltage: 3000 Vac/60 s ESR change rate ($\Delta ESR / ESR$): $\leq \pm 300\%$

Mechanical test

Test	Test condition	Performance
Resistance to solvent	IEC 60068-2-45 test XA method 1 Solvent: propanol (isopropyl-alcohol) Temperature: $+23 \pm 5^\circ\text{C}$ Immersion time: 5 ± 0.5 minutes Drying time: 5 minutes Mechanical treatment: 10 rubbing (with cotton-wool)	Capacitance change rate ($\Delta C/C$): $\leq \pm 1.0\%$ DF change ($\Delta tg \delta$): $\leq 50 \times 10^{-4}$ at 1 kHz Insulation resistance: $\geq 50\%$ of initial limit (T-T) test voltage: $1.5 \times U_R/10$ s (T-C) test voltage: 3000 Vac/60 s ESR change rate ($\Delta ESR / ESR$): $\leq \pm 300\%$
Terminal strength	Tension: $0.50 < D \leq 0.80$, 10N $0.80 < D \leq 1.25$, 20N Bending test : Bending force: $0.50 < D \leq 0.80$, 5N $0.80 < D \leq 1.25$, 10N Make two successive bends in each direction	No visible damage to appearance
Vibration resistance	Testing method per IEC 60068-2-6 Fc. Frequency Change: 10—55—10 Hz. Vibration Distance : 1.5 mm Test Direction : X, Y, Z Test Duration: 2 +1/- 0 hours each direction	Capacitance change rate ($\Delta C/C$): $\leq \pm 0.5\%$ DF change ($\Delta tg \delta$): $\leq 50 \times 10^{-4}$ at 1 kHz Insulation resistance: $\geq 50\%$ of initial limit (T-T) test voltage: $1.5 \times U_R/10$ s (T-C) test voltage: 3000 Vac/60 s ESR change rate ($\Delta ESR / ESR$): $\leq \pm 300\%$
Bump	1000 times, Acceleration: 400 m/s^2 Pulse duration: 6 ms	Capacitance change rate ($\Delta C/C$): $\leq \pm 0.5\%$ DF change ($\Delta tg \delta$): $\leq 50 \times 10^{-4}$ at 1 kHz Insulation resistance: $\geq 50\%$ of initial limit (T-T) test voltage: $1.5 \times U_R/10$ s (T-C) test voltage: 3000 Vac/60 s ESR change rate ($\Delta ESR / ESR$): $\leq \pm 300\%$

Packaging information

Pitch mm	Size	Dimension			Package quantity
	Code	W	H	T	Bulk pack/box
27.5	D02	32	18	9	340
	D03	32	20	11	280
	D04	32	22	13	230
	D06	32	24.5	13	230
	D07	32	24.5	15	200
	D08	32	28	14	220
	D10	32	30	16	190
	D12	32	33	18	170
	D13	32	37	22	140
37.5	E07	42	30	17	126
	E10	42	32	19	112
	E11	42	37	22	98
	E12	42	37	28	77
	E13	42	40	20	105
	E14	42	43	28	77
	E15	42	44	24	91
	E16	42	45	30	70
	E17	42	50	35	63
52.5	E18	42	55	40	49
	E19	42	60	45	49
	F01	57.5	45	25	60
	F02	57.5	45	30	50
	F03	57.5	50	35	45
	F04	57.5	55	45	35
	F06	57.5	65	45	35

Wave solder profile

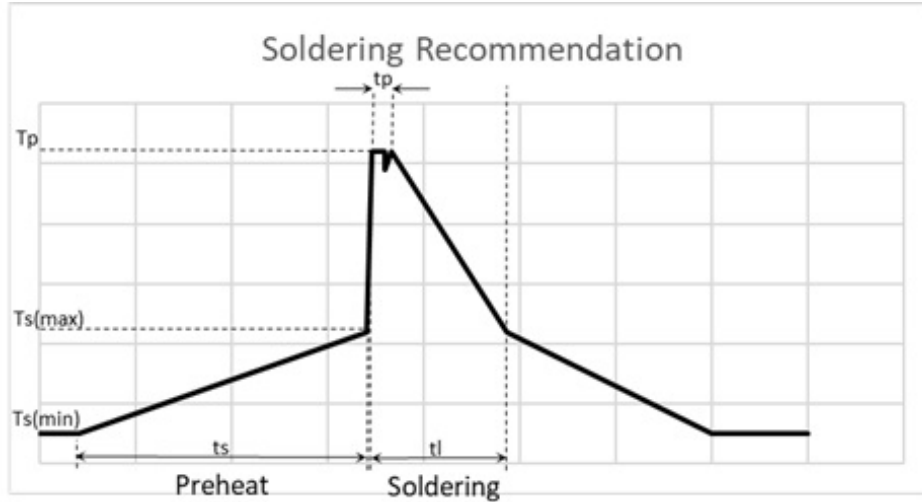

Profile feature

Preheat	• T_s maximum	110 °C
	• T_s minimum	NA
	• t_s	< 150 seconds
Solder	• T_p	260 °C \pm 5 °C
	• t_p	< 10 seconds
	• t_l	\leq 60 seconds

Capacitor body maximum temperature at wave soldering \leq 120 °C

Manual solder

+400 °C, 3 seconds maximum by soldering iron, generally manual, hand soldering is not recommended

Life Support Policy: Eaton does not authorize the use of any of its products for use in life support devices or systems without the express written approval of an officer of the Company. Life support systems are devices which support or sustain life, and whose failure to perform, when properly used in accordance with instructions for use provided in the labeling, can be reasonably expected to result in significant injury to the user.

Eaton reserves the right, without notice, to change design or construction of any products and to discontinue or limit distribution of any products. Eaton also reserves the right to change or update, without notice, any technical information contained in this bulletin.

Eaton
Electronics Division
1000 Eaton Boulevard
Cleveland, OH 44122
United States
Eaton.com/electronics

© 2023 Eaton
All Rights Reserved
Printed in USA
Publication No. ELX1260 BU-ELX22124
May 2023

Eaton is a registered trademark.

All other trademarks are property of their respective owners.

Follow us on social media to get the latest product and support information.

