

0.5mm Pitch
SERIES

6288

0.5mmピッチ RA SMT 下接点 ワンタッチロック
0.5mmPitch RA SMT Bottom contact One-touch lock

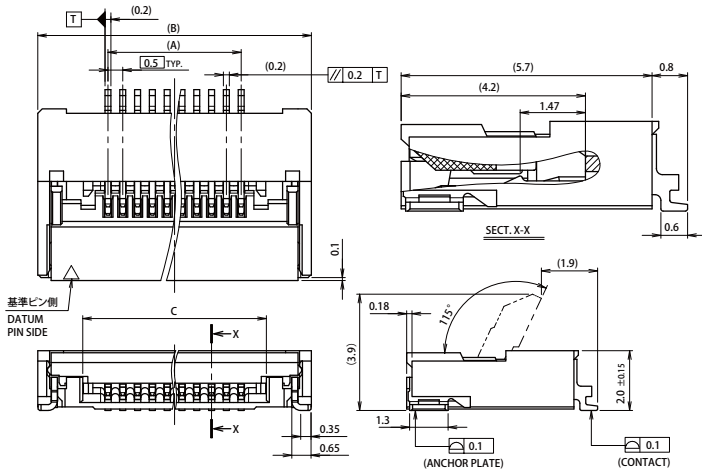

極数 NO. OF POS.	A	B	C	D	E
8	3.5	8.2	5.2	6.0	9.6
9	4.0	8.7	5.7	6.5	10.1
10	4.5	9.2	6.2	7.0	10.6
11	5.0	9.7	6.7	7.5	11.1
12	5.5	10.2	7.2	8.0	11.6
13	6.0	10.7	7.7	8.5	12.1
14	6.5	11.2	8.2	9.0	12.6
15	7.0	11.7	8.7	9.5	13.1
16	7.5	12.2	9.2	10.0	13.6
17	8.0	12.7	9.7	10.5	14.1
18	8.5	13.2	10.2	11.0	14.6
19	9.0	13.7	10.7	11.5	15.1
20	9.5	14.2	11.2	12.0	15.6
21	10.0	14.7	11.7	12.5	16.1
22	10.5	15.2	12.2	13.0	16.6
23	11.0	15.7	12.7	13.5	17.1
24	11.5	16.2	13.2	14.0	17.6
25	12.0	16.7	13.7	14.5	18.1
26	12.5	17.2	14.2	15.0	18.6
27	13.0	17.7	14.7	15.5	19.1
28	13.5	18.2	15.2	16.0	19.6
29	14.0	18.7	15.7	16.5	20.1
30	14.5	19.2	16.2	17.0	20.6

極数 NO. OF POS.	A	B	C	D	E
31	15.0	19.7	16.7	17.5	21.1
32	15.5	20.2	17.2	18.0	21.6
33	16.0	20.7	17.7	18.5	22.1
34	16.5	21.2	18.2	19.0	22.6
35	17.0	21.7	18.7	19.5	23.1
36	17.5	22.2	19.2	20.0	23.6
37	18.0	22.7	19.7	20.5	24.1
38	18.5	23.2	20.2	21.0	24.6
39	19.0	23.7	20.7	21.5	25.1
40	19.5	24.2	21.2	22.0	25.6
41	20.0	24.7	21.7	22.5	26.1
42	20.5	25.2	22.2	23.0	26.6
43	21.0	25.7	22.7	23.5	27.1
44	21.5	26.2	23.2	24.0	27.6
45	22.0	26.7	23.7	24.5	28.1
46	22.5	27.2	24.2	25.0	28.6
47	23.0	27.7	24.7	25.5	29.1
48	23.5	28.2	25.2	26.0	29.6
49	24.0	28.7	25.7	26.5	30.1
50	24.5	29.2	26.2	27.0	30.6
51	25.0	29.7	26.7	27.5	31.1
52	25.5	30.2	27.2	28.0	31.6
53	26.0	30.7	27.7	28.5	32.1
54	26.5	31.2	28.2	29.0	32.6
55	27.0	31.7	28.7	29.5	33.1
56	27.5	32.2	29.2	30.0	33.6
57	28.0	32.7	29.7	30.5	34.1
58	28.5	33.2	30.2	31.0	34.6
59	29.0	33.7	30.7	31.5	35.1
60	29.5	34.2	31.2	32.0	35.6
64	31.5	36.2	33.2	34.0	37.6
68	33.5	38.2	35.2	36.0	39.6
70	34.5	39.2	36.2	37.0	40.6
80	39.5	44.2	41.2	42.0	45.6

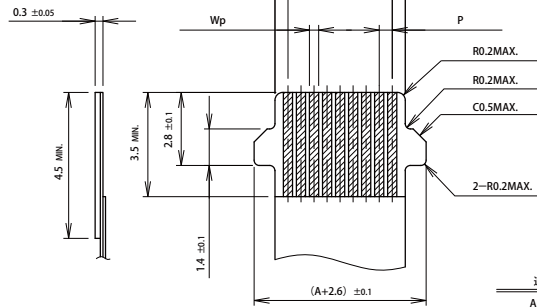
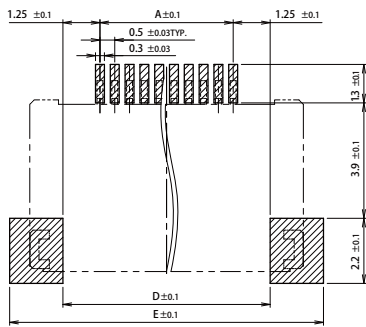

	FFC	
	1	2
M	0.5±0.07	0.5±0.08
P	0.5±0.03	0.5±0.05
A	A±0.05	A±0.05
W	W±0.07	W±0.07
Wp	0.35±0.03	0.32±0.03

通用FFC寸法は1か2を選択のこと。
SELECT AN APPLICABLE
FFC FROM 1 OR 2.

通用 FFC/FFC 寸法
APPLICABLE FFC/FFC

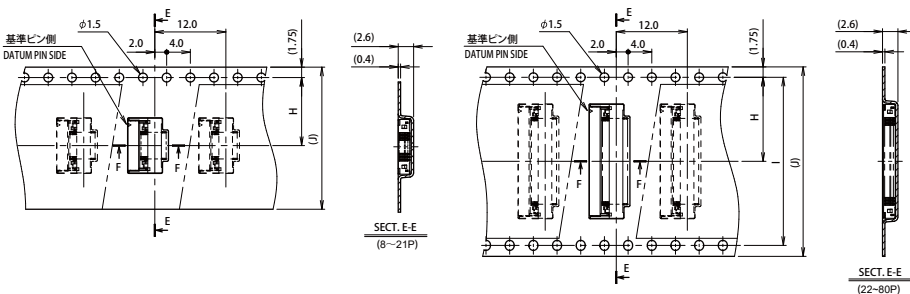

極数 NO. OF POS.	H	I	J
8-9	7.5	—	16.0
10-21	11.5	—	24.0
22-33	14.2	28.4	42.0
34-49	20.2	40.4	44.0
50-80	26.2	52.4	56.0

注文コード ORDERING CODE

04 6288 0XX X00 846+

RoHS 対応品

RoHS Compliant Product

金めっき Au Plated

0 : 使用温度範囲 Operating Temperature Range : -40 to +105°C

6 : 使用温度範囲 Operating Temperature Range : -40 to +125°C

極数 NUMBER OF POSITIONS

生産対応可能極数については、営業部に
ご確認願います。

Feel free to contact our sales department
for available numbers of positions.

梱包数量 2000個/リール
PACKING QUANTITY : 2000/Reel