

MOSFET – Dual, N-Channel, Asymmetric, POWER TRENCH[®], Power Stage

FDMS3669S

General Description

This device features two specialized N-Channel MOSFETs in a dual PQFN package. The switch node has been internally connected to enable easy placement and routing of synchronous buck converters. The control MOSFET (Q1) and synchronous SyncFET™ (Q2) have been designed to provide optimal power efficiency.

Features

- Q1: N-Channel
 - ◆ Max $R_{DS(on)}$ = 10 mΩ at $V_{GS} = 10\text{ V}$, $I_D = 13\text{ A}$
 - ◆ Max $R_{DS(on)}$ = 14.5 mΩ at $V_{GS} = 4.5\text{ V}$, $I_D = 10\text{ A}$
- Q2: N-Channel
 - ◆ Max $R_{DS(on)}$ = 5 mΩ at $V_{GS} = 10\text{ V}$, $I_D = 18\text{ A}$
 - ◆ Max $R_{DS(on)}$ = 5.2 mΩ at $V_{GS} = 4.5\text{ V}$, $I_D = 17\text{ A}$
- Low Inductance Packaging Shortens Rise/Fall Times, Resulting in Lower Switching Losses
- MOSFET Integration Enables Optimum Layout for Lower Circuit Inductance and Reduced Switch Node Ringing
- This Device is Pb-Free, Halide Free and is RoHS Compliant

Applications

- Computing
- Communications
- General Purpose Point of Load
- Notebook VCORE

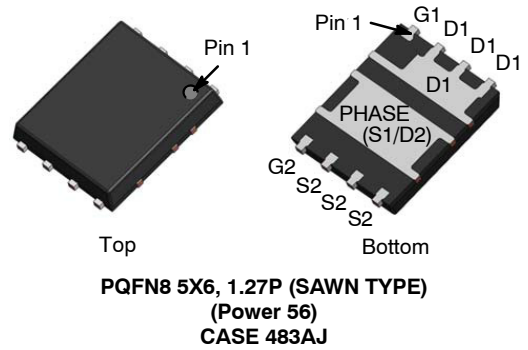

MARKING DIAGRAM



&Z = Assembly Plant Code
&3 = 3-Digit Date Code
&K = 2-Digits Lot Run Code
9ACF21CD = Specific Device Code

PIN CONNECTIONS

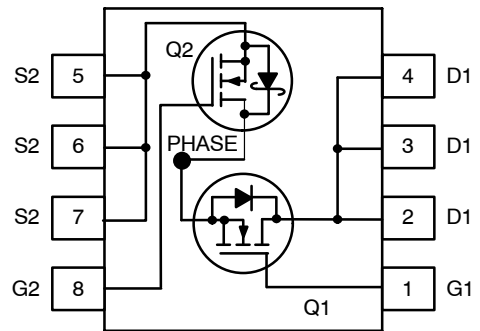

ORDERING INFORMATION

See detailed ordering and shipping information on page 14 of this data sheet.

FDMS3669S

MOSFET MAXIMUM RATINGS ($T_A = 25^\circ\text{C}$ unless otherwise noted)

Symbol	Parameter	Q1	Q2	Unit	
V_{DS}	Drain to Source Voltage	30	30	V	
V_{GS}	Gate to Source Voltage (Note 3)	± 20	± 12	V	
I_D	Drain Current	- Continuous (Package Limited) $T_C = 25^\circ\text{C}$	24	60	A
		- Continuous (Silicon Limited) $T_C = 25^\circ\text{C}$	43	75	
		- Continuous $T_A = 25^\circ\text{C}$	13 (Note 1a)	18 (Note 1b)	
		- Pulsed (Note 6)	50	60	
E_{AS}	Single Pulse Avalanche Energy	61 (Note 4)	48 (Note 5)	mJ	
P_D	Power Dissipation for Single Operation	$T_A = 25^\circ\text{C}$	2.2 (Note 1a)	2.5 (Note 1b)	W
		$T_A = 25^\circ\text{C}$	1.0 (Note 1c)	1.0 (Note 1d)	
T_J, T_{STG}	Operating and Storage Junction Temperature Range	-55 to +150		$^\circ\text{C}$	

Stresses exceeding those listed in the Maximum Ratings table may damage the device. If any of these limits are exceeded, device functionality should not be assumed, damage may occur and reliability may be affected.

THERMAL CHARACTERISTICS

Symbol	Characteristic	Q1	Q2	Unit
$R_{\theta JA}$	Thermal Resistance, Junction to Ambient	57 (Note 1a)	50 (Note 1b)	$^\circ\text{C}/\text{W}$
$R_{\theta JA}$	Thermal Resistance, Junction to Ambient	125 (Note 1c)	120 (Note 1d)	
$R_{\theta JC}$	Thermal Resistance, Junction to Case	5.0	2.8	

ELECTRICAL CHARACTERISTICS ($T_J = 25^\circ\text{C}$ unless otherwise noted)

Symbol	Parameter	Test Condition	Type	Min	Typ	Max	Unit
OFF CHARACTERISTICS							
BV_{DSS}	Drain to Source Breakdown Voltage	$I_D = 250 \mu\text{A}, V_{GS} = 0 \text{ V}$ $I_D = 1 \text{ mA}, V_{GS} = 0 \text{ V}$	Q1 Q2	30 30	- -	- -	V
$\frac{\Delta BV_{DSS}}{\Delta T_J}$	Breakdown Voltage Temperature Coefficient	$I_D = 250 \mu\text{A}$, referenced to 25°C $I_D = 10 \text{ mA}$, referenced to 25°C	Q1 Q2	- -	16 20	- -	$\text{mV}/^\circ\text{C}$
I_{DSS}	Zero Gate Voltage Drain Current	$V_{DS} = 24 \text{ V}, V_{GS} = 0 \text{ V}$	Q1 Q2	- -	- -	1 500	μA
I_{GSS}	Gate to Source Leakage Current	$V_{GS} = 20 \text{ V}, V_{DS} = 0 \text{ V}$ $V_{GS} = 12 \text{ V}, V_{DS} = 0 \text{ V}$	Q1 Q2	- -	- -	100 100	nA

ON CHARACTERISTICS

$V_{GS(th)}$	Gate to Source Threshold Voltage	$V_{GS} = V_{DS}, I_D = 250 \mu\text{A}$ $V_{GS} = V_{DS}, I_D = 1 \text{ mA}$	Q1 Q2	1.1 1.1	2 1.5	2.7 2.5	V
$\frac{\Delta V_{GS(th)}}{\Delta T_J}$	Gate to Source Threshold Voltage Temperature Coefficient	$I_D = 250 \mu\text{A}$, referenced to 25°C $I_D = 10 \text{ mA}$, referenced to 25°C	Q1 Q2	- -	-6 -3	- -	$\text{mV}/^\circ\text{C}$
$R_{DS(on)}$	Drain to Source On Resistance	$V_{GS} = 10 \text{ V}, I_D = 13 \text{ A}$ $V_{GS} = 4.5 \text{ V}, I_D = 10 \text{ A}$ $V_{GS} = 10 \text{ V}, I_D = 13 \text{ A}, T_J = 125^\circ\text{C}$	Q1	- - -	8.1 12 11	10 14.5 14.5	m Ω
		$V_{GS} = 10 \text{ V}, I_D = 18 \text{ A}$ $V_{GS} = 4.5 \text{ V}, I_D = 17 \text{ A}$ $V_{GS} = 10 \text{ V}, I_D = 18 \text{ A}, T_J = 125^\circ\text{C}$	Q2	- - -	2.8 3.5 4.0	5.0 5.2 7.1	
g _{FS}	Forward Transconductance	$V_{DS} = 5 \text{ V}, I_D = 13 \text{ A}$	Q1	-	53	-	S
		$V_{DS} = 5 \text{ V}, I_D = 18 \text{ A}$	Q2	-	113	-	

FDMS3669S

ELECTRICAL CHARACTERISTICS (T_J = 25°C unless otherwise noted) (continued)

Symbol	Parameter	Test Condition	Type	Min	Typ	Max	Unit
DYNAMIC CHARACTERISTICS							
C _{iss}	Input Capacitance	Q1: V _{DS} = 15 V, V _{GS} = 0 V, f = 1 MHz	Q1 Q2	– –	1205 1469	1605 2060	pF
C _{oss}	Output Capacitance	Q2: V _{DS} = 15 V, V _{GS} = 0 V, f = 1 MHz	Q1 Q2	– –	370 485	495 680	pF
C _{rss}	Reverse Transfer Capacitance		Q1 Q2	– –	35 59	55 90	pF
R _g	Gate Resistance		Q1 Q2	0.3 0.2	1.6 1.4	3.2 3.0	Ω

SWITCHING CHARACTERISTICS

t _{d(on)}	Turn-On Delay Time	Q1: V _{DD} = 15 V, I _D = 13 A, R _{GEN} = 6 Ω	Q1 Q2	– –	9 7	18 14	ns
t _r	Rise Time	Q2: V _{DD} = 15 V, I _D = 18 A, R _{GEN} = 6 Ω	Q1 Q2	– –	3 3	10 10	ns
t _{d(off)}	Turn-Off Delay Time		Q1 Q2	– –	20 24	36 40	ns
t _f	Fall Time		Q1 Q2	– –	3 3	10 10	ns
Q _{g(Tot)}	Total Gate Charge	V _{GS} = 0 V to 10 V Q1 V _{DD} = 15 V, I _D = 13 A Q2 V _{DD} = 15 V, I _D = 18 A	Q1 Q2	– –	17 24	24 34	nC
Q _{g(Tot)}	Total Gate Charge	V _{GS} = 0 V to 4.5 V Q1 V _{DD} = 15 V, I _D = 13 A Q2 V _{DD} = 15 V, I _D = 18 A	Q1 Q2	– –	7.5 12	12 17	nC
Q _{gs}	Gate to Source Gate Charge	Q1 V _{DD} = 15 V, I _D = 13 A	Q1 Q2	– –	3.9 3.3	– –	nC
Q _{gd}	Gate to Drain "Miller" Charge	Q2 V _{DD} = 15 V, I _D = 18 A	Q1 Q2	– –	2.0 3.6	– –	nC

DRAIN-SOURCE CHARACTERISTICS

V _{SD}	Source to Drain Diode Forward Voltage	V _{GS} = 0 V, I _S = 13 A (Note 2) V _{GS} = 0 V, I _S = 2 A (Note 2) V _{GS} = 0 V, I _S = 18 A (Note 2) V _{GS} = 0 V, I _S = 2 A (Note 2)	Q1 Q1 Q2 Q2	– –	0.8 0.7 0.8 0.7	1.2 1.2 1.2 1.2	V
t _{rr}	Reverse Recovery Time	Q1 I _F = 13 A, di/dt = 100 A/μs	Q1 Q2	– –	24 21	38 33	ns
Q _{rr}	Reverse Recovery Charge	Q2 I _F = 18 A, di/dt = 300 A/μs	Q1 Q2	– –	8 16	15 31	nC

Product parametric performance is indicated in the Electrical Characteristics for the listed test conditions, unless otherwise noted. Product performance may not be indicated by the Electrical Characteristics if operated under different conditions.

FDMS3669S

NOTES:

- $R_{\theta JA}$ is determined with the device mounted on a 1 in² pad 2 oz copper pad on a 1.5 x 1.5 in. board of FR-4 material. $R_{\theta JC}$ is guaranteed by design while $R_{\theta CA}$ is determined by the user's board design.

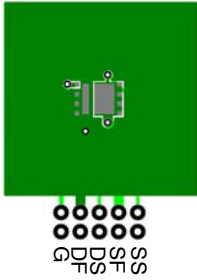

a. 57°C/W when mounted on a 1 in² pad of 2 oz copper

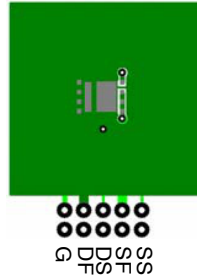

b. 50°C/W when mounted on a 1 in² pad of 2 oz copper



c. 125°C/W when mounted on a minimum pad of 2 oz copper



d. 120°C/W when mounted on a minimum pad of 2 oz copper

- Pulse Test: Pulse Width < 300 μ s, Duty cycle < 2.0%.
- As an N-ch device, the negative Vgs rating is for low duty cycle pulse occurrence only. No continuous rating is implied with the negative Vgs rating.
- E_{AS} of 61 mJ is based on starting $T_J = 25^\circ\text{C}$; N-ch: $L = 3$ mH, $I_{AS} = 6.4$ A, $V_{DD} = 30$ V, $V_{GS} = 10$ V. 100% test at $L = 0.1$ mH, $I_{AS} = 20$ A.
- E_{AS} of 48 mJ is based on starting $T_J = 25^\circ\text{C}$; N-ch: $L = 3$ mH, $I_{AS} = 5.7$ A, $V_{DD} = 30$ V, $V_{GS} = 10$ V. 100% test at $L = 0.1$ mH, $I_{AS} = 17$ A.
- Pulsed Id limited by junction temperature, $t_d \leq 10$ μ s. Please refer to SOA curve for more details.

TYPICAL CHARACTERISTICS (Q1 N-CHANNEL)

($T_J = 25^\circ\text{C}$ unless otherwise noted)

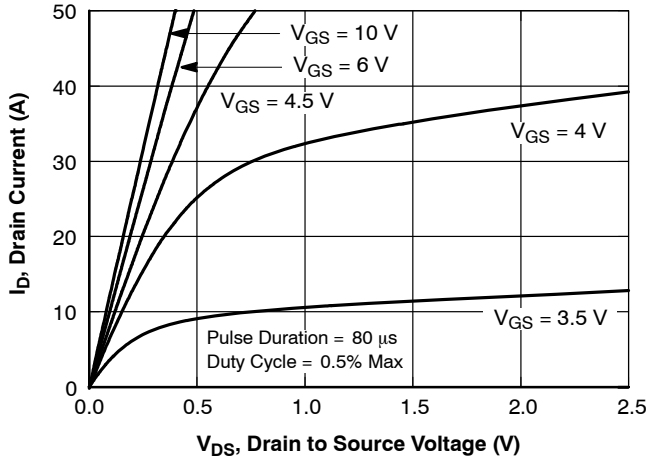

Figure 1. On Region Characteristics

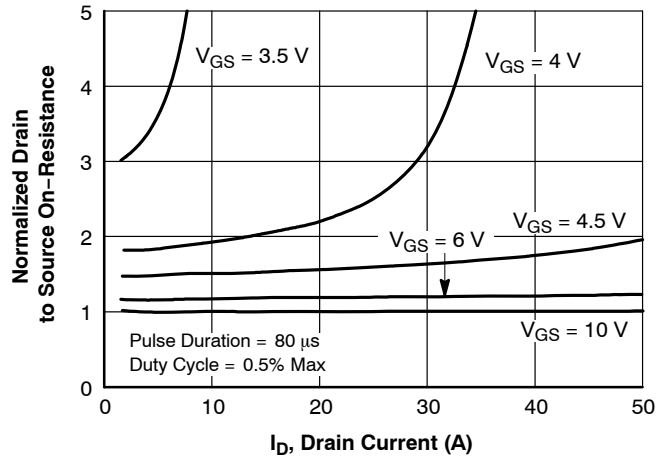

Figure 2. Normalized On-Resistance vs. Drain Current and Gate Voltage

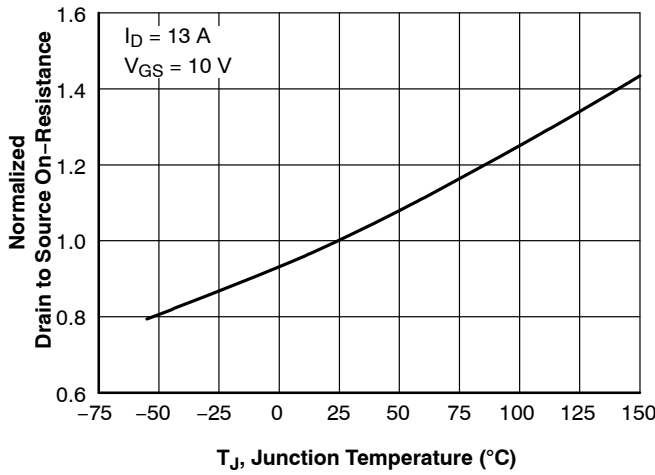

Figure 3. Normalized On Resistance vs. Junction Temperature

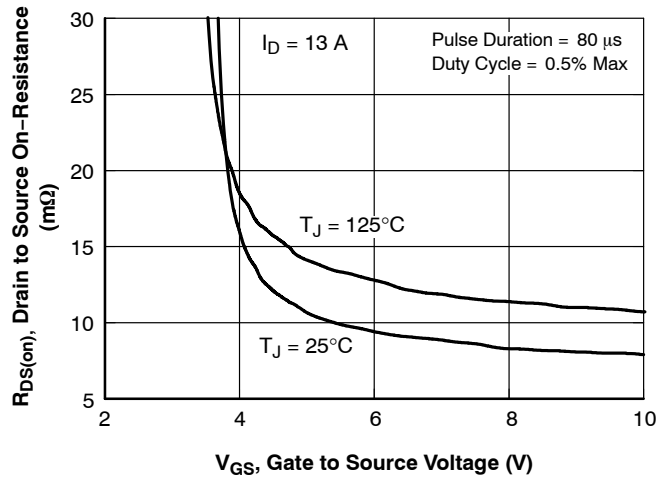

Figure 4. On-Resistance vs. Gate to Source Voltage

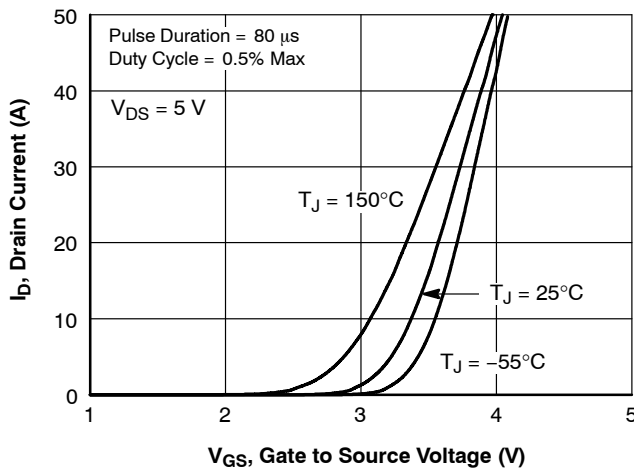

Figure 5. Transfer Characteristics

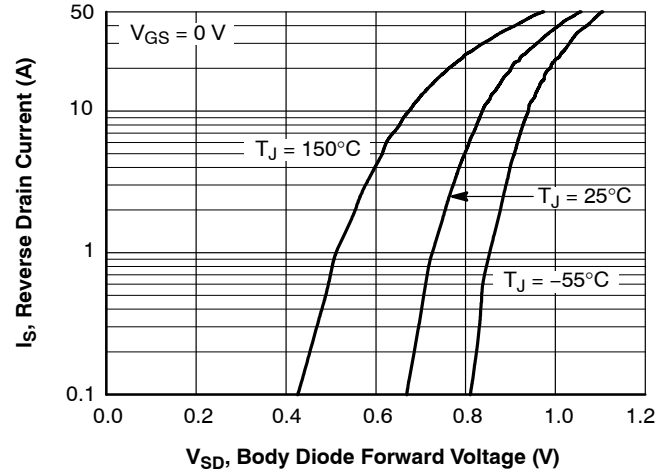

Figure 6. Source to Drain Diode Forward Voltage vs. Source Current

TYPICAL CHARACTERISTICS (Q1 N-CHANNEL) (continued)

($T_J = 25^\circ\text{C}$ unless otherwise noted)

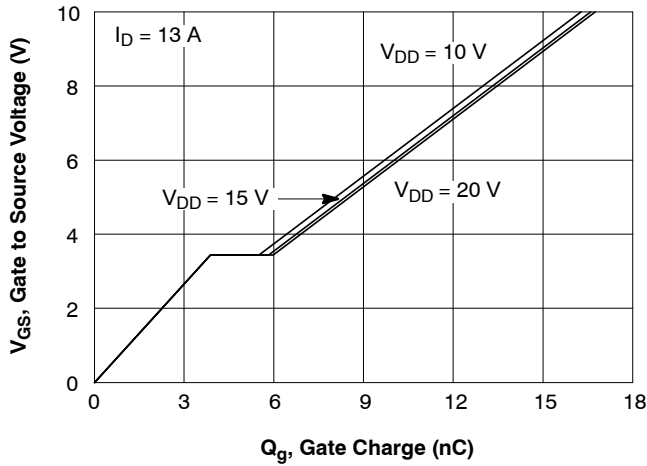

Figure 7. Gate Charge Characteristics

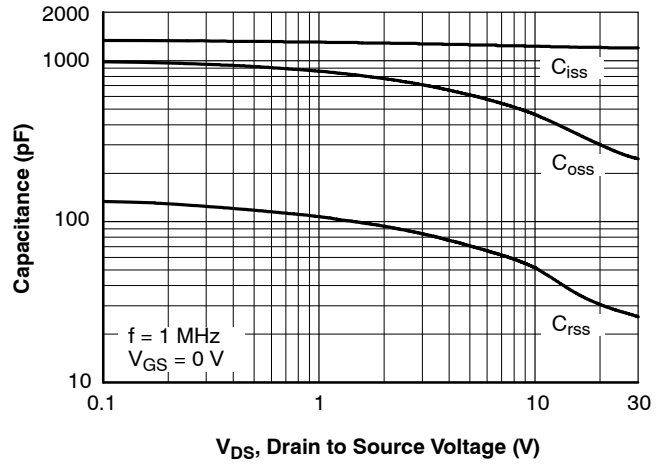

Figure 8. Capacitance vs. Drain to Source Voltage

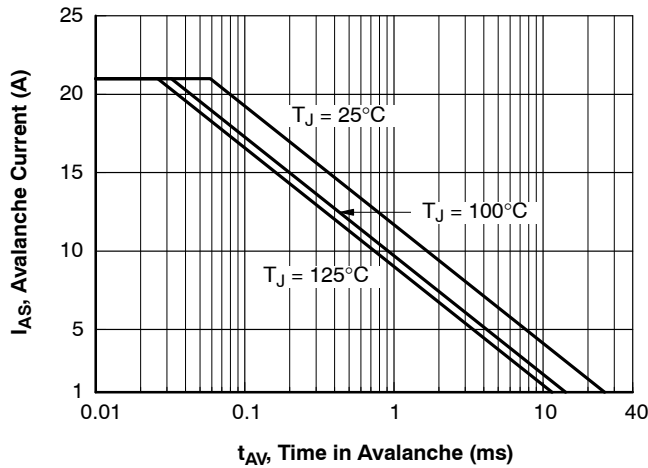

Figure 9. Unclamped Inductive Switching Capability

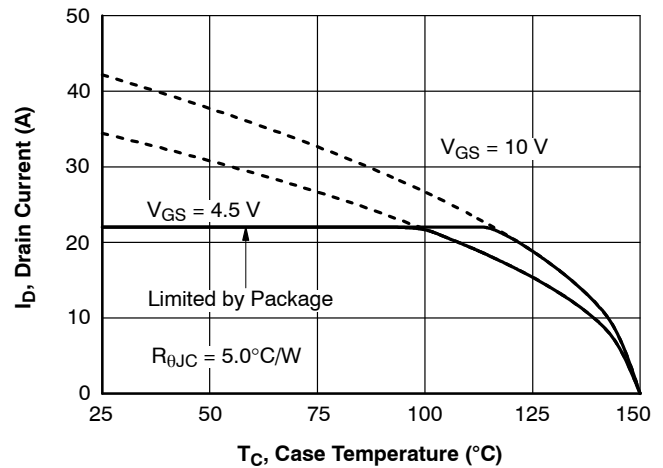

Figure 10. Maximum Continuous Drain Current vs. Case Temperature

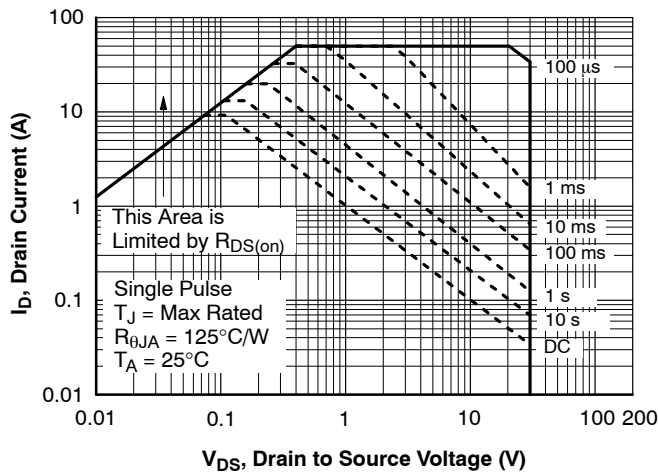

Figure 11. Forward Bias Safe Operating Area

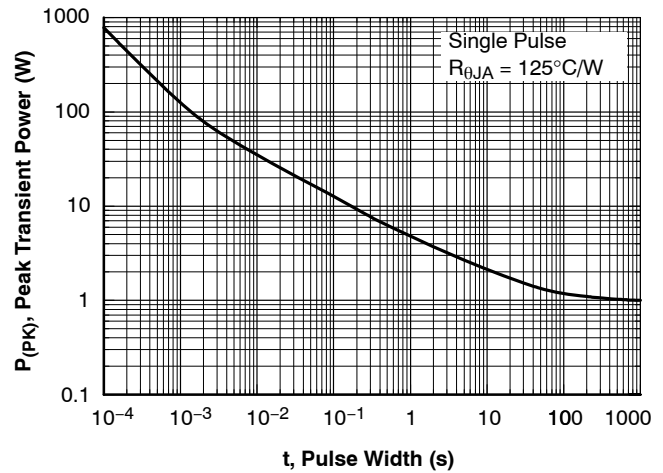

Figure 12. Single Pulse Maximum Power Dissipation

TYPICAL CHARACTERISTICS (Q1 N-CHANNEL) (continued)

($T_J = 25^\circ\text{C}$ unless otherwise noted)

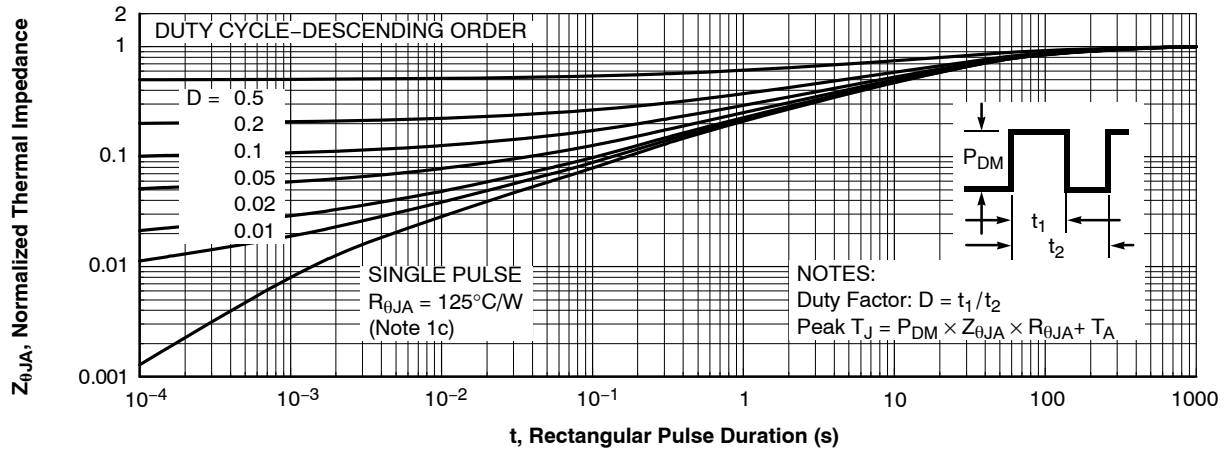

Figure 13. Junction-to-Ambient Transient Thermal Response Curve

TYPICAL CHARACTERISTICS (Q2 N-CHANNEL)

($T_J = 25^\circ\text{C}$ unless otherwise noted)

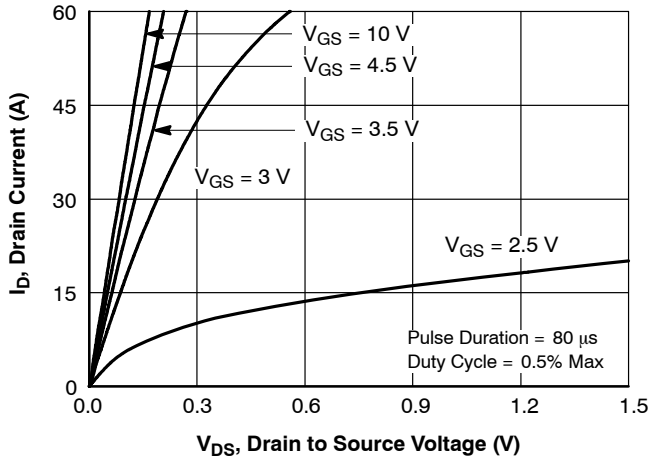

Figure 14. On Region Characteristics

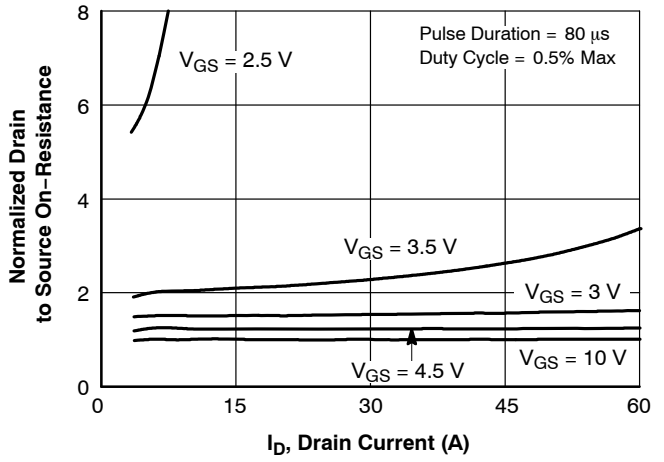

Figure 15. Normalized On-Resistance vs. Drain Current and Gate Voltage

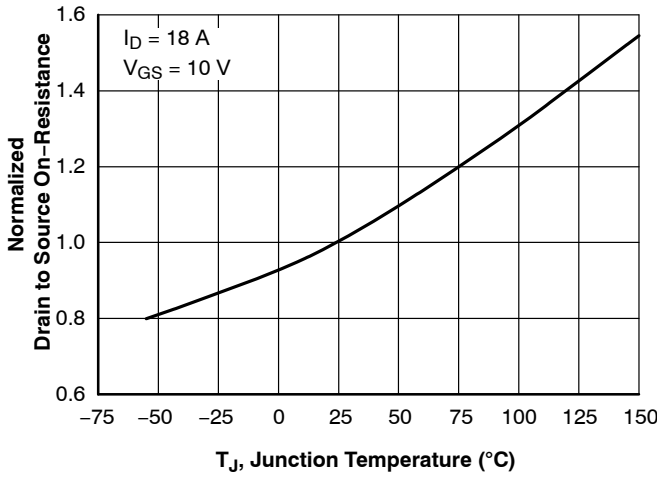

Figure 16. Normalized On Resistance vs. Junction Temperature

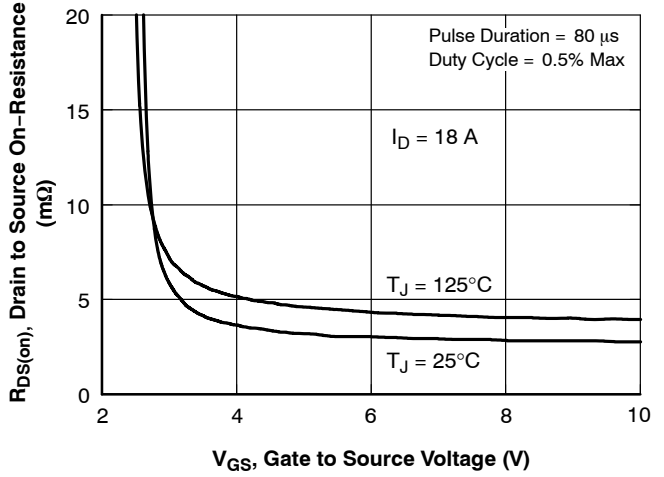

Figure 17. On-Resistance vs. Gate to Source Voltage

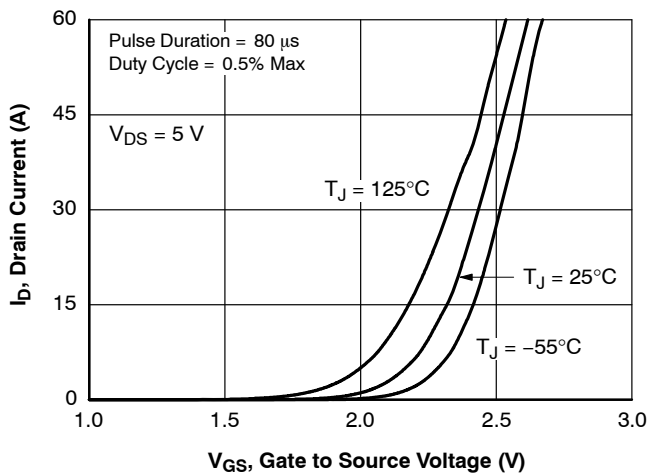

Figure 18. Transfer Characteristics

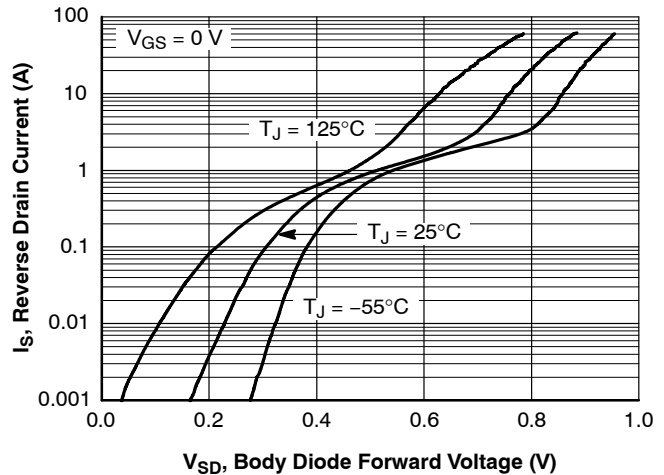

Figure 19. Source to Drain Diode Forward Voltage vs. Source Current

TYPICAL CHARACTERISTICS (Q2 N-CHANNEL) (continued)

($T_J = 25^\circ\text{C}$ unless otherwise noted) (continued)

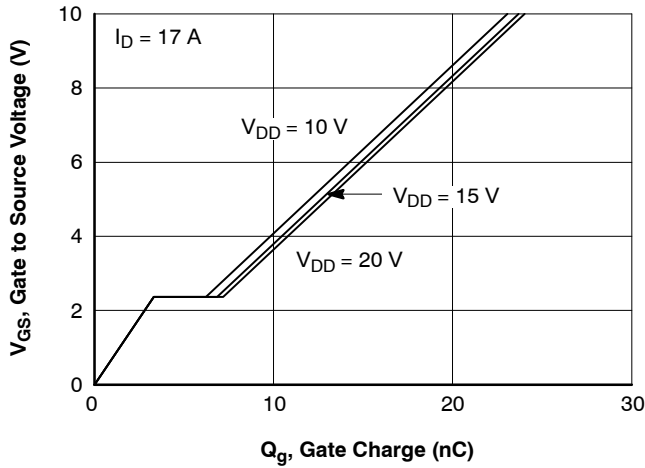

Figure 20. Gate Charge Characteristics

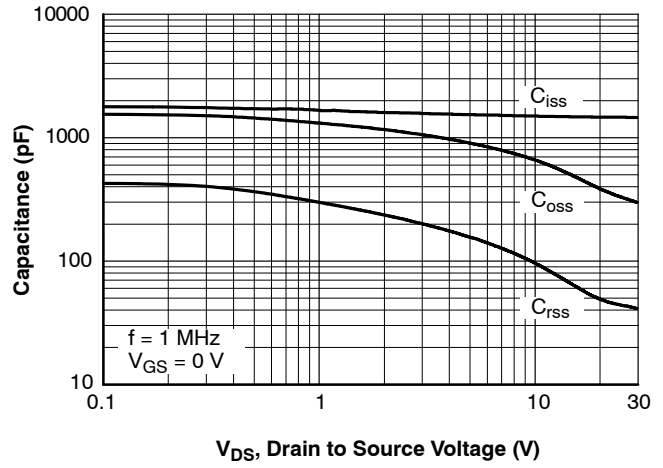

Figure 21. Capacitance vs. Drain to Source Voltage

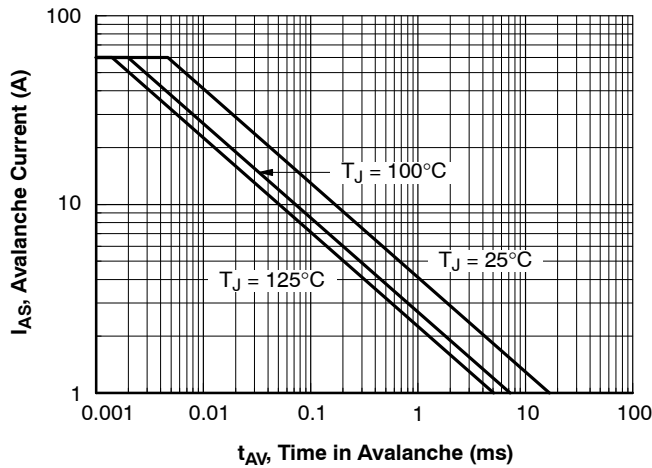

Figure 22. Unclamped Inductive Switching Capability

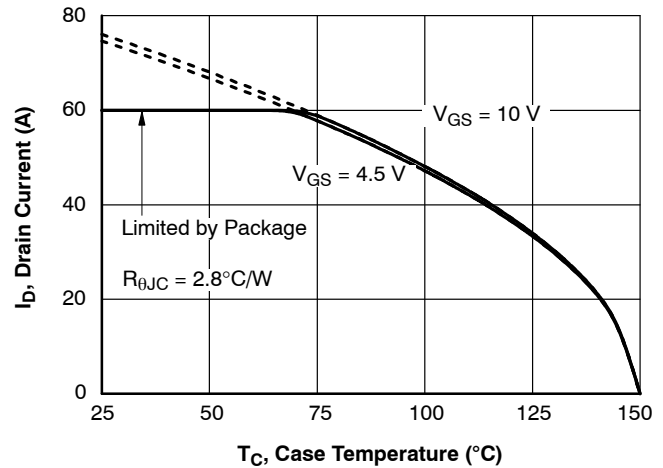

Figure 23. Maximum Continuous Drain Current vs. Case Temperature

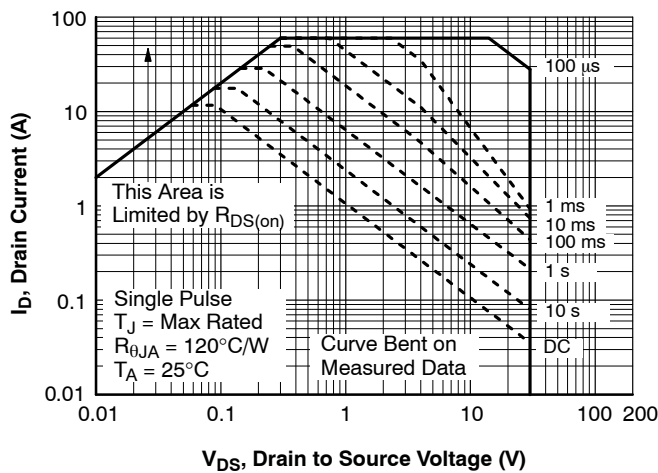

Figure 24. Forward Bias Safe Operating Area

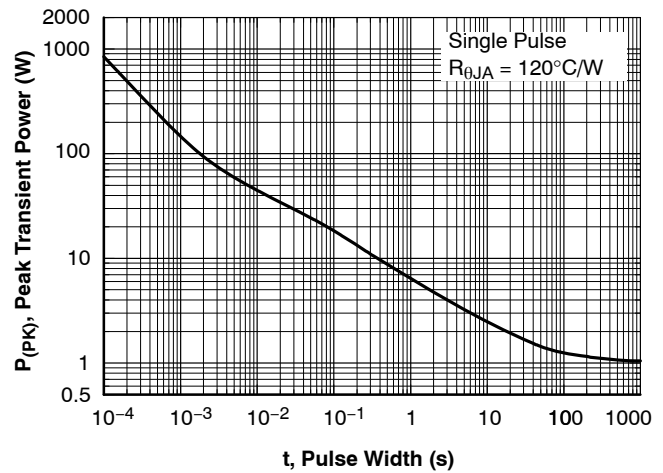

Figure 25. Single Pulse Maximum Power Dissipation

TYPICAL CHARACTERISTICS (Q2 N-CHANNEL) (continued)

($T_J = 25^\circ\text{C}$ unless otherwise noted)

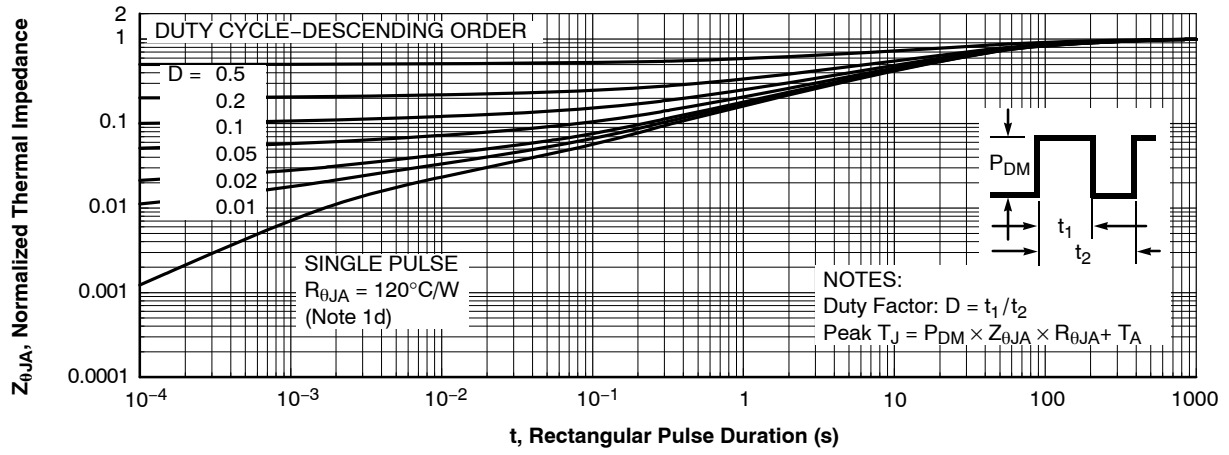

Figure 26. Junction-to-Ambient Transient Thermal Response Curve

TYPICAL CHARACTERISTICS (continued)

SyncFET Schottky Body Diode Characteristics

onsemi's SyncFET process embeds a Schottky diode in parallel with POWERTRENCH MOSFET. This diode exhibits similar characteristics to a discrete external Schottky diode in parallel with a MOSFET. Figure 27 shows the reverse recovery characteristic of the FDMS3669S.

Schottky barrier diodes exhibit significant leakage at high temperature and high reverse voltage. This will increase the power in the device.

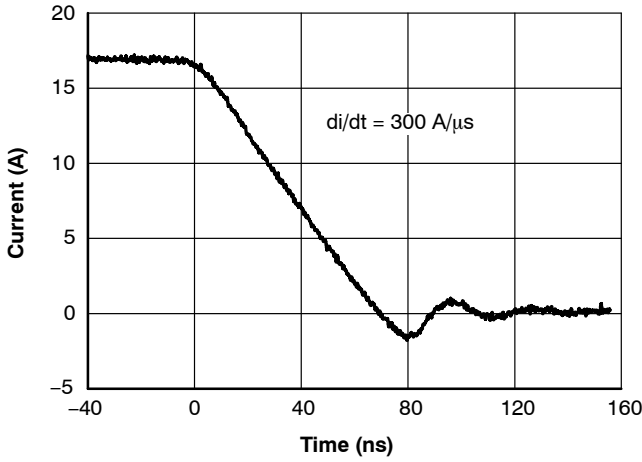

Figure 27. FDMS3669S SyncFET Body Diode Reverse Recovery Characteristics

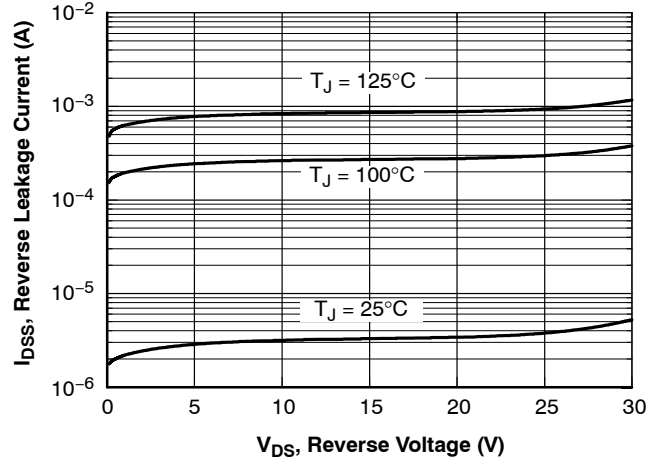

Figure 28. SyncFET Body Diode Reverse Leakage vs. Drain-Source Voltage

APPLICATION INFORMATION

Switch Node Ringing Suppression

onsemi's Power Stage products incorporate a proprietary design* that minimizes the peak overshoot, ringing voltage on the switch node (PHASE) without the need of any

external snubbing components in a buck converter. As shown in the Figure 29, the Power Stage solution rings significantly less than competitor solutions under the same set of test conditions.

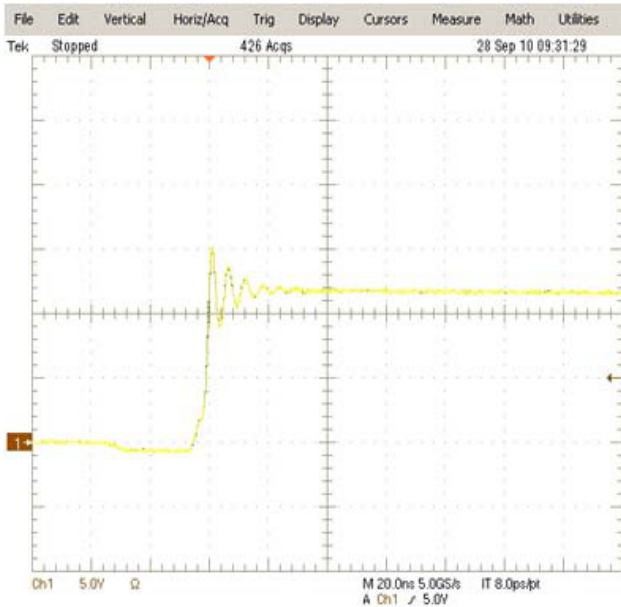

Power Stage Device

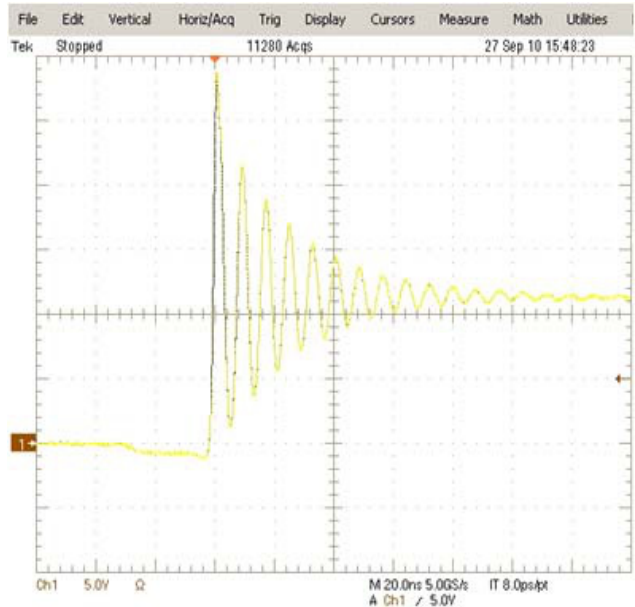

Competitors Solution

Figure 29. Power Stage Phase Node Rising Edge, High Side Turn On

*Patent Pending

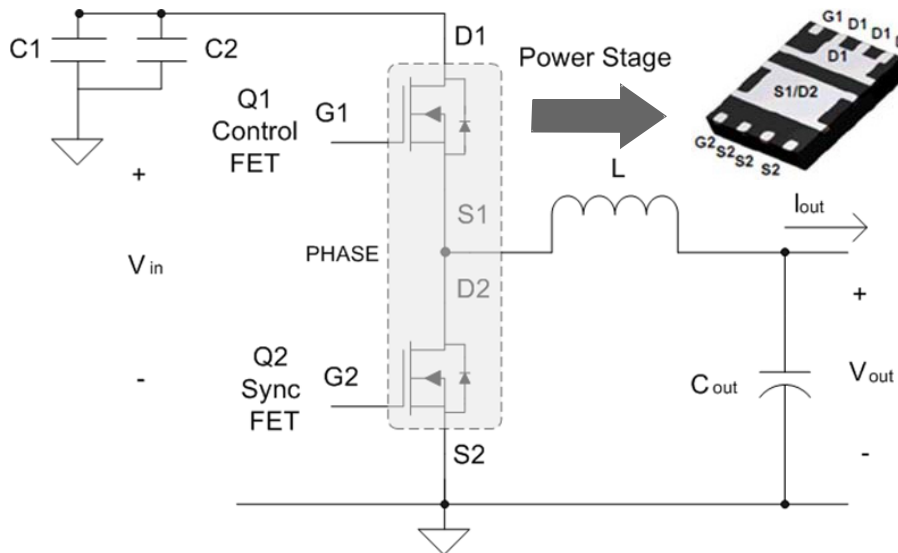

Figure 30. Shows the Power Stage in a Buck Converter Topology

Recommended PCB Layout Guidelines

As a PCB designer, it is necessary to address critical issues in layout to minimize losses and optimize the performance of the power train. Power Stage is a high power density solution and all high current flow paths, such as VIN (D1), PHASE

(S1/D2) and GND (S2), should be short and wide for better and stable current flow, heat radiation and system performance. A recommended layout procedure is discussed below to maximize the electrical and thermal performance of the part.

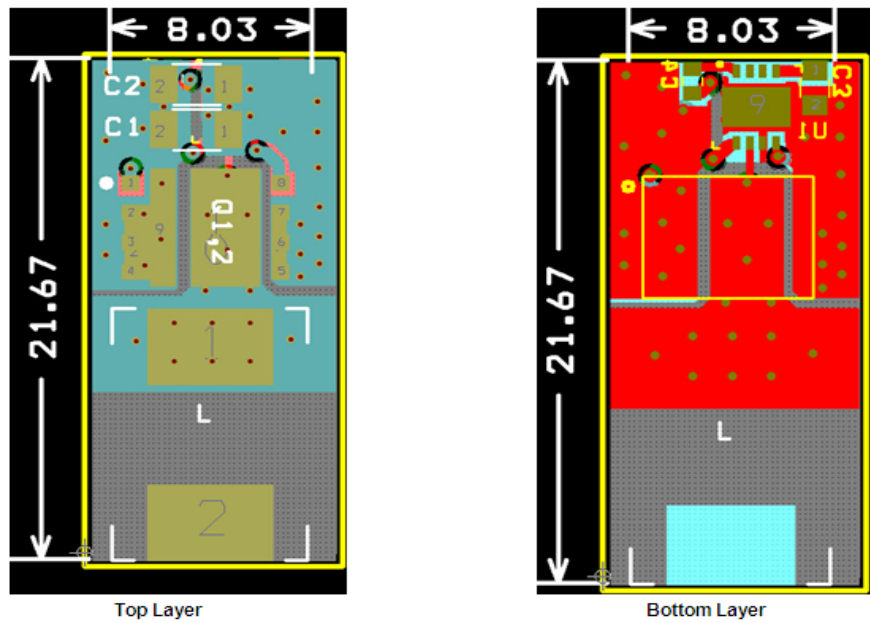

Figure 31. Recommended PCB Layout

Following is a guideline, not a requirement which the PCB designer should consider:

1. Input ceramic bypass capacitors C1 and C2 must be placed close to the D1 and S2 pins of Power Stage to help reduce parasitic inductance and High Frequency conduction loss induced by switching operation. C1 and C2 show the bypass capacitors placed close to the part between D1 and S2. Input capacitors should be connected in parallel close to the part. Multiple input caps can be connected depending upon the application.
2. The PHASE copper trace serves two purposes; In addition to being the current path from the Power Stage package to the output inductor (L), it also serves as heat sink for the lower FET in the Power Stage package. The trace should be short and wide enough to present a low resistance path for the high current flow between the Power Stage and the inductor. This is done to minimize conduction losses and limit temperature rise. Please note that the PHASE node is a high voltage and high frequency switching node with high noise potential. Care should be taken to minimize coupling to adjacent traces. The reference layout in Figure 31 shows a good balance between the thermal and electrical performance of Power Stage.
3. Output inductor location should be as close as possible to the Power Stage device for lower power

- loss due to copper trace resistance. A shorter and wider PHASE trace to the inductor reduces the conduction loss. Preferably the Power Stage should be directly in line (as shown in Figure 31) with the inductor for space savings and compactness.
4. The POWER TRENCH Technology MOSFETs used in the Power Stage are effective at minimizing phase node ringing. It allows the part to operate well within the breakdown voltage limits. This eliminates the need to have an external snubber circuit in most cases. If the designer chooses to use an RC snubber, it should be placed close to the part between the PHASE pad and S2 pins to dampen the high-frequency ringing.
5. The driver IC should be placed close to the Power Stage part with the shortest possible paths for the High Side gate and Low Side gates through a wide trace connection. This eliminates the effect of parasitic inductance and resistance between the driver and the MOSFET and turns the devices on and off as efficiently as possible. At higher-frequency operation this impedance can limit the gate current trying to charge the MOSFET input capacitance. This will result in slower rise and fall times and additional switching losses. Power Stage has both the gate pins on the same side of the package which allows for back mounting of the driver IC to the board. This provides a very compact path for the drive signals and improves efficiency of the part.

FDMS3669S

- S2 pins should be connected to the GND plane with multiple vias for a low impedance grounding. Poor grounding can create a noise transient offset voltage level between S2 and driver ground. This could lead to faulty operation of the gate driver and MOSFET.
- Use multiple vias on each copper area to interconnect top, inner and bottom layers to help smooth current flow and heat conduction. Vias

should be relatively large, around 8 mils to 10 mils, and of reasonable inductance. Critical high frequency components such as ceramic bypass caps should be located close to the part and on the same side of the PCB. If not feasible, they should be connected from the backside via a network of low inductance vias.

PACKAGE MARKING AND ORDERING INFORMATION

Device	Device Marking	Package Type	Reel Size	Tape Width	Shipping [†]
FDMS3669S	9ACF 21CD	PQFN8 5X6, 1.27P (Power 56) (Pb-Free, Halide Free)	13"	12 mm	3000 / Tape & Reel

[†]For information on tape and reel specifications, including part orientation and tape sizes, please refer to our Tape and Reel Packaging Specifications Brochure, BRD8011/D.

POWERTRENCH is registered trademark of Semiconductor Components Industries, LLC dba "onsemi" or its affiliates and/or subsidiaries in the United States and/or other countries.

SyncFET is trademark of Semiconductor Components Industries, LLC dba "onsemi" or its affiliates and/or subsidiaries in the United States and/or other countries.

MECHANICAL CASE OUTLINE

PACKAGE DIMENSIONS

ON Semiconductor®

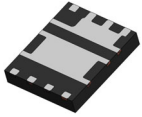

PQFN8 5X6, 1.27P (SAWN TYPE)

CASE 483AJ
ISSUE A

DATE 08 FEB 2021

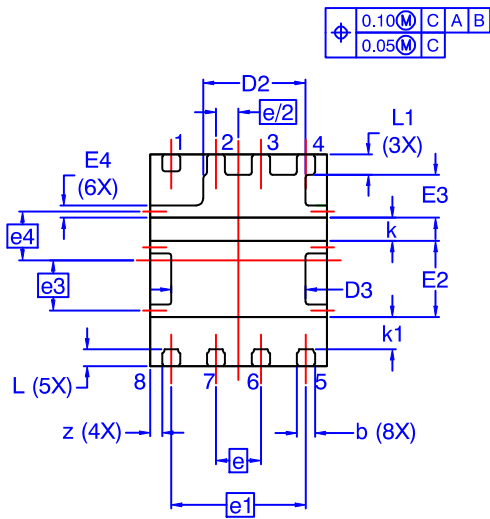
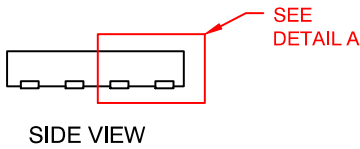
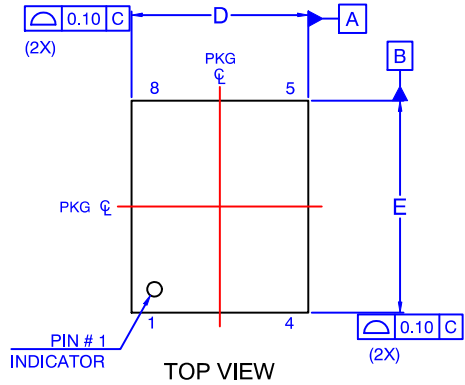

OPTION - A (SAWN TYPE)

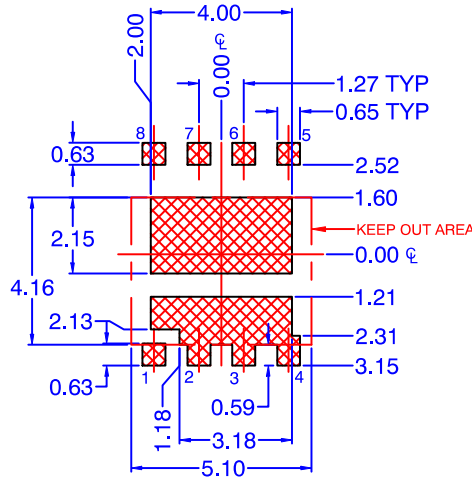

*FOR ADDITIONAL INFORMATION ON OUR PB-FREE STRATEGY AND SOLDERING DETAILS, PLEASE DOWNLOAD THE ON SEMICONDUCTOR SOLDERING AND MOUNTING TECHNIQUES REFERENCE MANUAL, SOLDERRM/D.

DIM	MILLIMETERS		
	MIN.	NOM.	MAX.
A	0.90	1.00	1.10
A1	0.00	-	0.05
b	0.31	0.51	0.61
c	0.10	0.20	0.30
D	4.90	5.00	5.10
D2	2.80	2.90	3.16
D3	3.70	3.80	4.08
E	5.90	6.00	6.25
E2	2.05	2.15	2.25
E3	1.12	1.22	1.34
E4	0.25	0.35	0.45
e	1.27 BSC		
e1	3.81 BSC		
e/2	0.635 BSC		
e3	1.43 BSC		
e4	1.38 BSC		
k	0.61	0.66	0.71
k1	0.82	0.92	1.02
L	0.38	0.48	0.65
L1	0.48	0.58	0.68
z	0.34 REF		

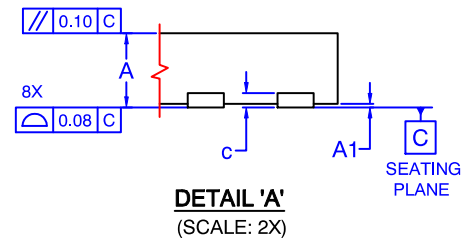

DOCUMENT NUMBER:	98AON13659G	Electronic versions are uncontrolled except when accessed directly from the Document Repository. Printed versions are uncontrolled except when stamped "CONTROLLED COPY" in red.
DESCRIPTION:	PQFN8 5X6, 1.27P	PAGE 1 OF 2

ON Semiconductor and ON are trademarks of Semiconductor Components Industries, LLC dba ON Semiconductor or its subsidiaries in the United States and/or other countries. ON Semiconductor reserves the right to make changes without further notice to any products herein. ON Semiconductor makes no warranty, representation or guarantee regarding the suitability of its products for any particular purpose, nor does ON Semiconductor assume any liability arising out of the application or use of any product or circuit, and specifically disclaims any and all liability, including without limitation special, consequential or incidental damages. ON Semiconductor does not convey any license under its patent rights nor the rights of others.

MECHANICAL CASE OUTLINE

PACKAGE DIMENSIONS

ON Semiconductor®



PQFN8 5X6, 1.27P (PUNCHED TYPE)

CASE 483AJ
ISSUE A

DATE 08 FEB 2021

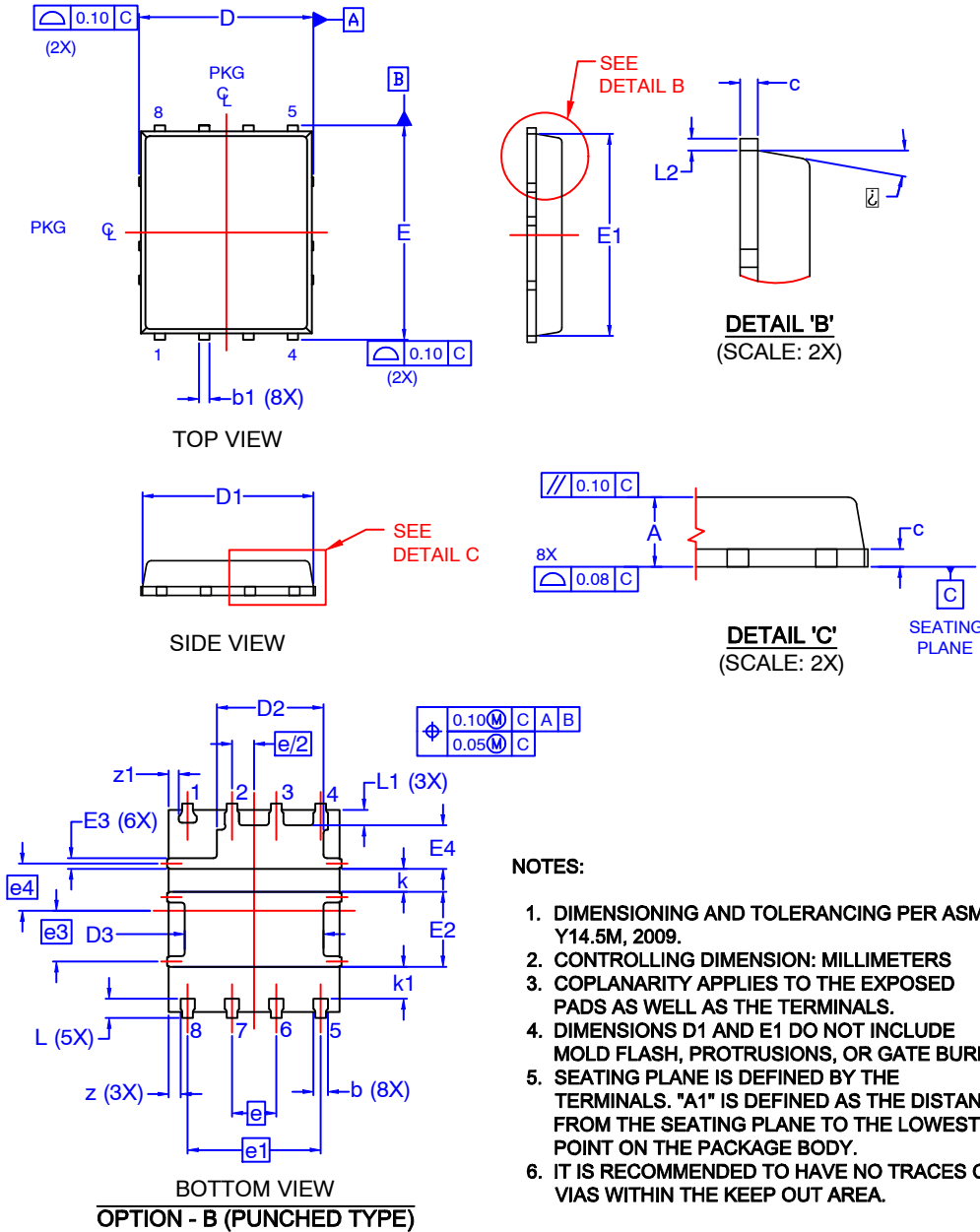

DIM	MILLIMETERS		
	MIN.	NOM.	MAX.
A	0.90	1.00	1.10
b	0.31	0.51	0.61
b1	0.21	0.31	0.41
c	0.15	0.25	0.35
D	4.90	5.00	5.10
D1	4.80	4.90	5.00
D2	2.80	3.06	3.16
D3	3.70	3.98	4.08
E	5.90	6.00	6.25
E1	5.70	5.80	5.90
E2	2.05	2.15	2.25
E3	0.25	0.33	0.45
E4	1.12	1.24	1.34
e	1.27 BSC		
e1	3.81 BSC		
e/2	0.635 BSC		
e3	1.45 BSC		
e4	1.36 BSC		
k	0.61	0.66	0.71
k1	0.82	0.92	1.02
L	0.38	0.55	0.65
L1	0.35	0.45	0.55
L2	0.08	0.18	0.28
z	0.34 REF		
z1	0.28 REF		
θ	0°	-	10°

NOTES:

1. DIMENSIONING AND TOLERANCING PER ASME Y14.5M, 2009.
2. CONTROLLING DIMENSION: MILLIMETERS
3. COPLANARITY APPLIES TO THE EXPOSED PADS AS WELL AS THE TERMINALS.
4. DIMENSIONS D1 AND E1 DO NOT INCLUDE MOLD FLASH, PROTRUSIONS, OR GATE BURRS.
5. SEATING PLANE IS DEFINED BY THE TERMINALS. "A1" IS DEFINED AS THE DISTANCE FROM THE SEATING PLANE TO THE LOWEST POINT ON THE PACKAGE BODY.
6. IT IS RECOMMENDED TO HAVE NO TRACES OR VIAS WITHIN THE KEEP OUT AREA.

DOCUMENT NUMBER:	98AON13659G	Electronic versions are uncontrolled except when accessed directly from the Document Repository. Printed versions are uncontrolled except when stamped "CONTROLLED COPY" in red.
DESCRIPTION:	PQFN8 5X6, 1.27P	PAGE 2 OF 2

ON Semiconductor and ON are trademarks of Semiconductor Components Industries, LLC dba ON Semiconductor or its subsidiaries in the United States and/or other countries. ON Semiconductor reserves the right to make changes without further notice to any products herein. ON Semiconductor makes no warranty, representation or guarantee regarding the suitability of its products for any particular purpose, nor does ON Semiconductor assume any liability arising out of the application or use of any product or circuit, and specifically disclaims any and all liability, including without limitation special, consequential or incidental damages. ON Semiconductor does not convey any license under its patent rights nor the rights of others.

onsemi, **Onsemi**, and other names, marks, and brands are registered and/or common law trademarks of Semiconductor Components Industries, LLC dba "**onsemi**" or its affiliates and/or subsidiaries in the United States and/or other countries. **onsemi** owns the rights to a number of patents, trademarks, copyrights, trade secrets, and other intellectual property. A listing of **onsemi**'s product/patent coverage may be accessed at www.onsemi.com/site/pdf/Patent-Marking.pdf. **onsemi** reserves the right to make changes at any time to any products or information herein, without notice. The information herein is provided "as-is" and **onsemi** makes no warranty, representation or guarantee regarding the accuracy of the information, product features, availability, functionality, or suitability of its products for any particular purpose, nor does **onsemi** assume any liability arising out of the application or use of any product or circuit, and specifically disclaims any and all liability, including without limitation special, consequential or incidental damages. Buyer is responsible for its products and applications using **onsemi** products, including compliance with all laws, regulations and safety requirements or standards, regardless of any support or applications information provided by **onsemi**. "Typical" parameters which may be provided in **onsemi** data sheets and/or specifications can and do vary in different applications and actual performance may vary over time. All operating parameters, including "Typicals" must be validated for each customer application by customer's technical experts. **onsemi** does not convey any license under any of its intellectual property rights nor the rights of others. **onsemi** products are not designed, intended, or authorized for use as a critical component in life support systems or any FDA Class 3 medical devices or medical devices with a same or similar classification in a foreign jurisdiction or any devices intended for implantation in the human body. Should Buyer purchase or use **onsemi** products for any such unintended or unauthorized application, Buyer shall indemnify and hold **onsemi** and its officers, employees, subsidiaries, affiliates, and distributors harmless against all claims, costs, damages, and expenses, and reasonable attorney fees arising out of, directly or indirectly, any claim of personal injury or death associated with such unintended or unauthorized use, even if such claim alleges that **onsemi** was negligent regarding the design or manufacture of the part. **onsemi** is an Equal Opportunity/Affirmative Action Employer. This literature is subject to all applicable copyright laws and is not for resale in any manner.

ADDITIONAL INFORMATION

TECHNICAL PUBLICATIONS:

Technical Library: www.onsemi.com/design/resources/technical-documentation
onsemi Website: www.onsemi.com

ONLINE SUPPORT: www.onsemi.com/support

For additional information, please contact your local Sales Representative at www.onsemi.com/support/sales