



qBox DIY IOT Enclosure Plus Kits

User Manual

Abstract

User Manual describing the qBox DIY IOT Enclosure Plus Kits.
Kits features, content and project ideas provided.

IBT-QBX-CON-X-UM

www.iot-bots.com





Table of Contents

Revision History	2
Overview.....	3
Features.....	3
Description	3
qBox Enclosure Plus Kit (No SMA)	4
qBox Enclosure Plus Kit (One SMA)	5
qBox Enclosure Plus Kit (Two SMAs)	6
qBox Enclosure Plus Kit parts	7
Specification	13
qBox Enclosure Plus Kit content.....	14
Project ideas	14
Abbreviations.....	15
Trademark notice.....	15
Ordering info	15



Revision History

NoNo	Version	Date	Author	Description
1	1.0	05.25.2020	lotbotscom	Initial
2	1.1	11.03.2020	lotbotscom	Brand Identity Update
3				



Overview

Perfect for any DIY IOT project, qBox Enclosure Plus Kit series is the part of the newest HW platform designed to help hobbyists, makers and all DIYers to build environmental ready IOT solutions.

Features

- Flanged IP65 waterproof enclosure: Sealed, made of high-quality ABS material suitable for indoor and outdoor DIY IOT projects;
- Incorporated PG7 cable glands: Two cable inputs securely allow bringing the power in and connecting sensors and actuators;
- Perfect fit PCB: High-quality double-sided PCB with 0.1" hole spacing for DIP integrated circuits, modules, and main controller board;
- Fixed placement for controller board: Well-designed PCB allows to carry a variety of MCU boards like Adafruit Feather Compatible, Arduino MKR Compatible, NodeMCU, etc;
- Built in SMA connectors: Up to two SMA Straight Female to IPEX (u.FL) adapter cables give external antennas connections to your wireless board;
- Dedicated Connectors positions: Terminal blocks, Grove and 0.1" DIP power and interface connectors could be easily soldered onto the PCB;
- Arduino UNO compatible board carrier capability: Arduino UNO compatible board could be mounted at the top of PCB with fasteners kit included;
- Prototyping connectors set included: All necessary connectors included, saving time and allows to build IOT device right away.

Description

Each qBox Enclosure Plus Kit consists of durable waterproof IP65 enclosure with installed PG7 glands, double sided PCB with dedicated placements for IOT controller and connectors and integrated SMA to u.FL adapter cable (up to two, depending on kit model) and connectors set.

qBox Enclosure Plus Kit (No SMA)

qBox Enclosure Plus Kit (No SMA) is the simplest member in qBox Enclosure Plus Kit family. It has no integrated SMA to u.FL adapter cable, but still able to keep wireless connectivity device with internal antennas.

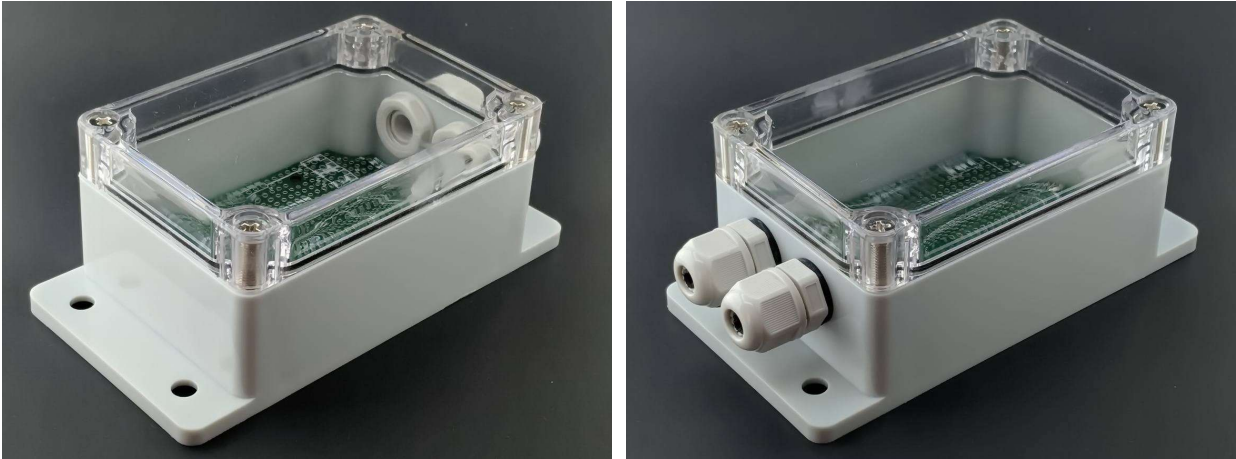

Pic.1. qBox Enclosure Plus Kit (No SMA) common view

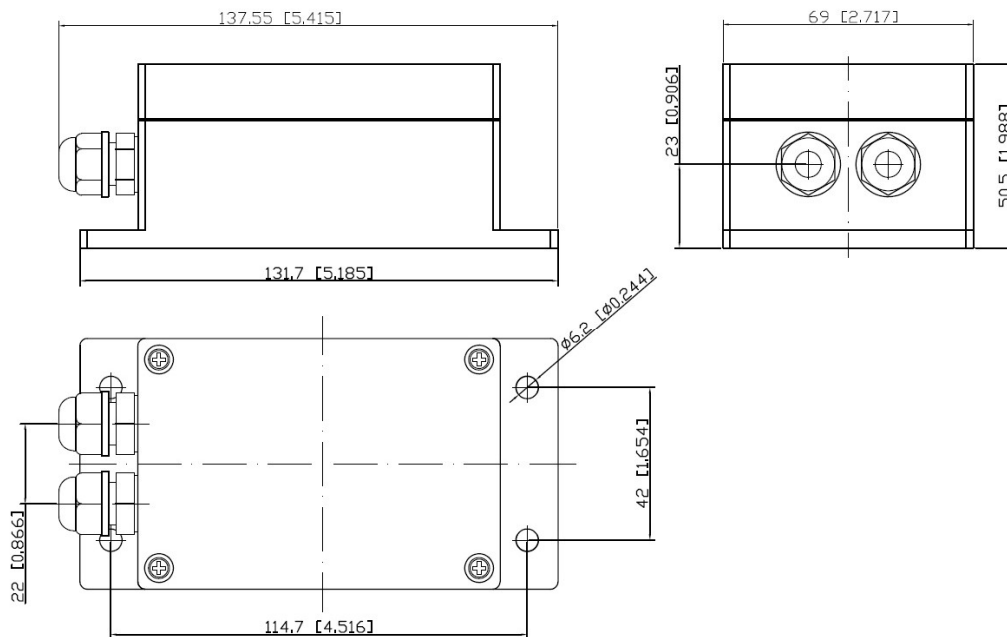

Pic. 2. qBox Enclosure Plus Kit (No SMA) dimensions

qBox Enclosure Plus Kit (One SMA)

qBox Enclosure Plus Kit (One SMA) is the member of qBox Enclosure Plus Kit family which is able to bring up to one external antenna signal to IOT device located inside. It has one integrated SMA to u.FL adapter cable.

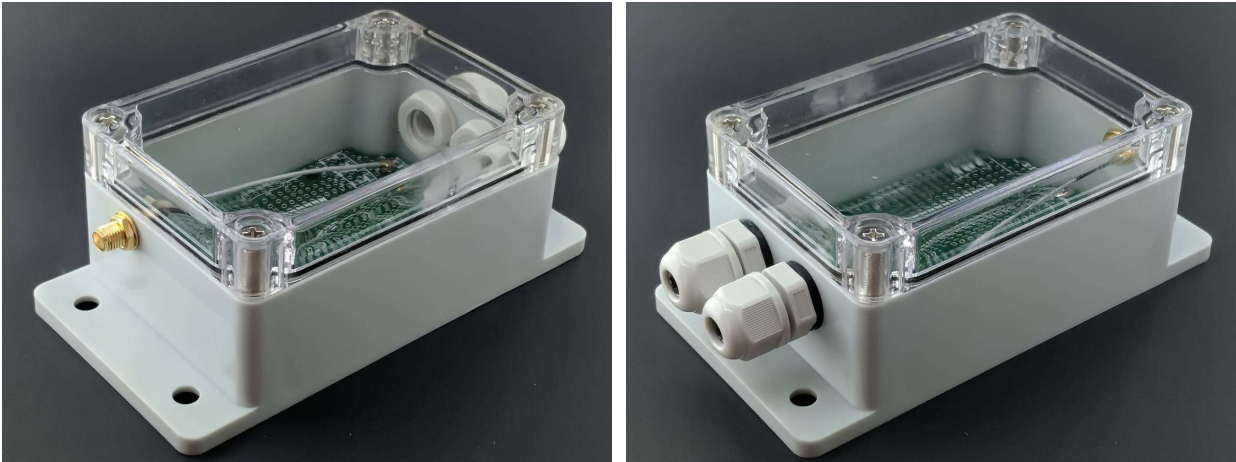

Pic.3. qBox Enclosure Plus Kit (One SMA) common view

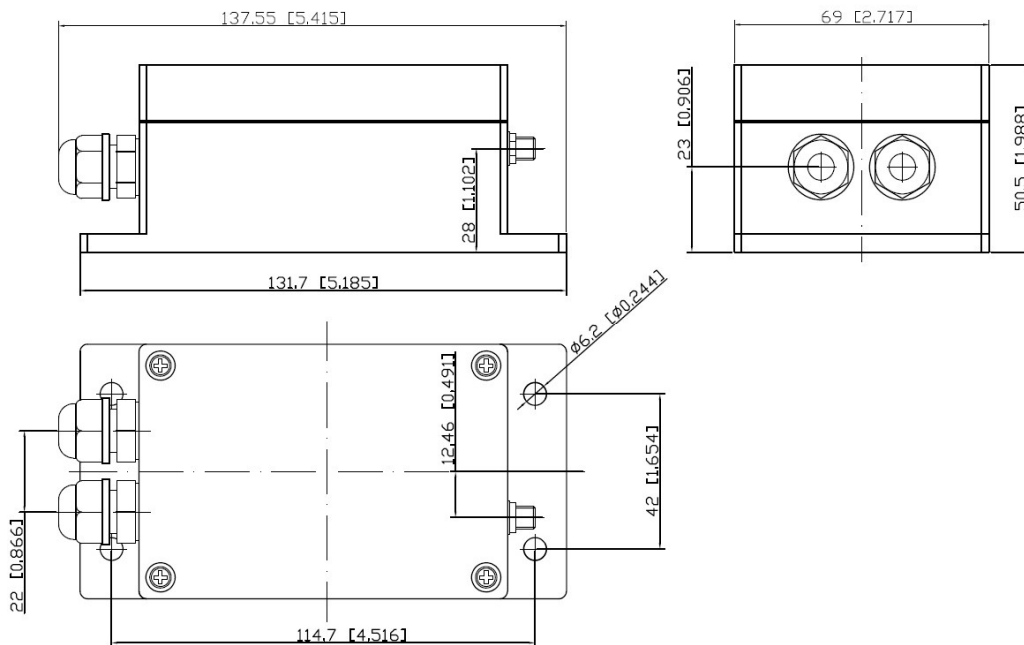

Pic. 4. qBox Enclosure Plus Kit (One SMA) dimensions

qBox Enclosure Plus Kit (Two SMA)

qBox Enclosure Plus Kit (Two SMA) is the most charged member of qBox Enclosure Plus Kit family which has got two integrated SMA to u.FL adapter cables.

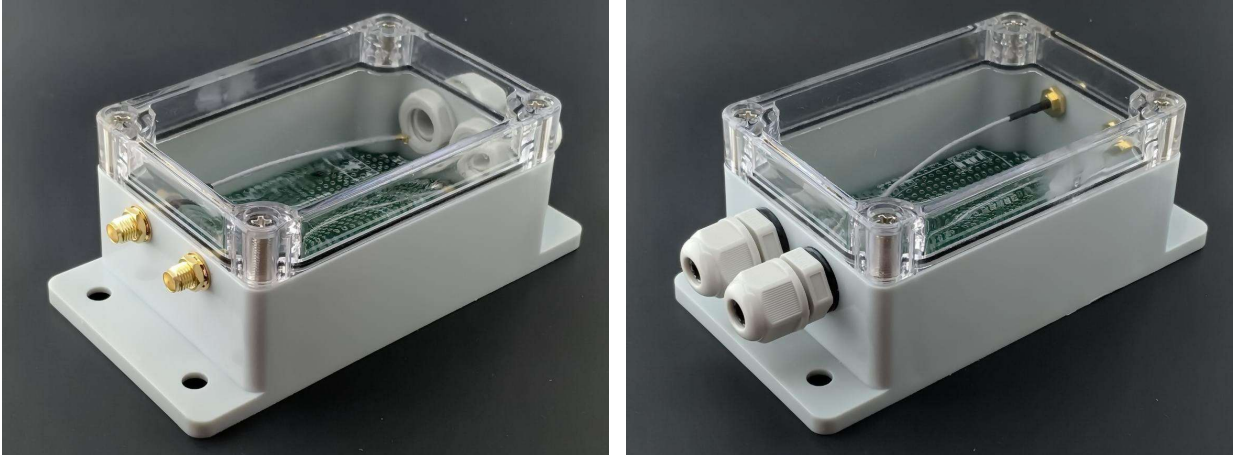

Pic.5. qBox Enclosure Plus Kit (Two SMA) common view

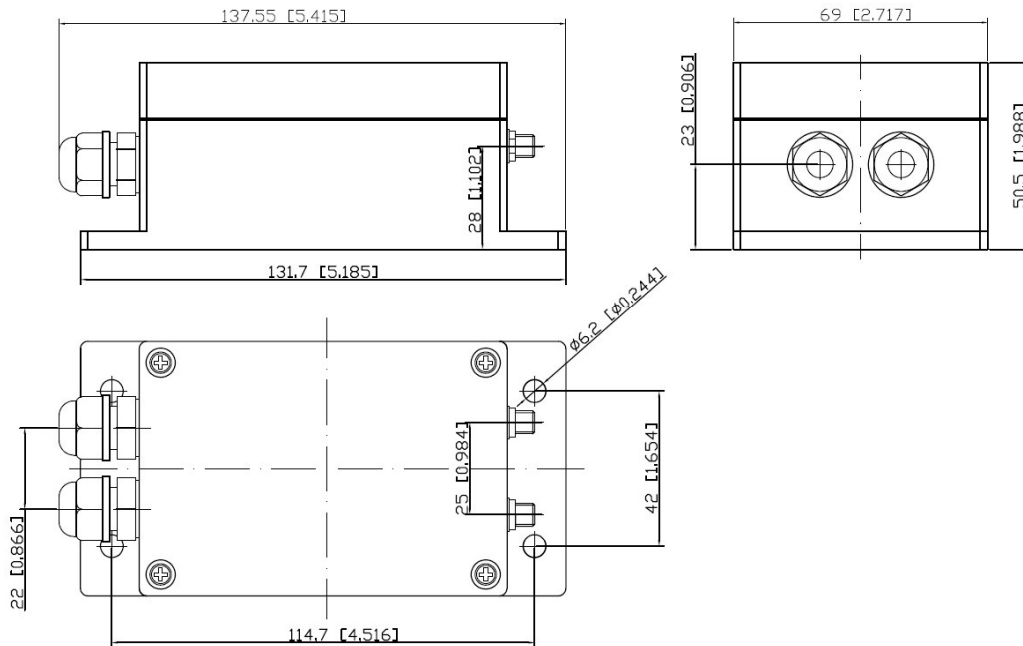

Pic. 6. qBox Enclosure Plus Kit (Two SMA) dimensions

qBox Enclosure Plus Kit parts

Each qBox Enclosure Plus Kit has got several parts built in.

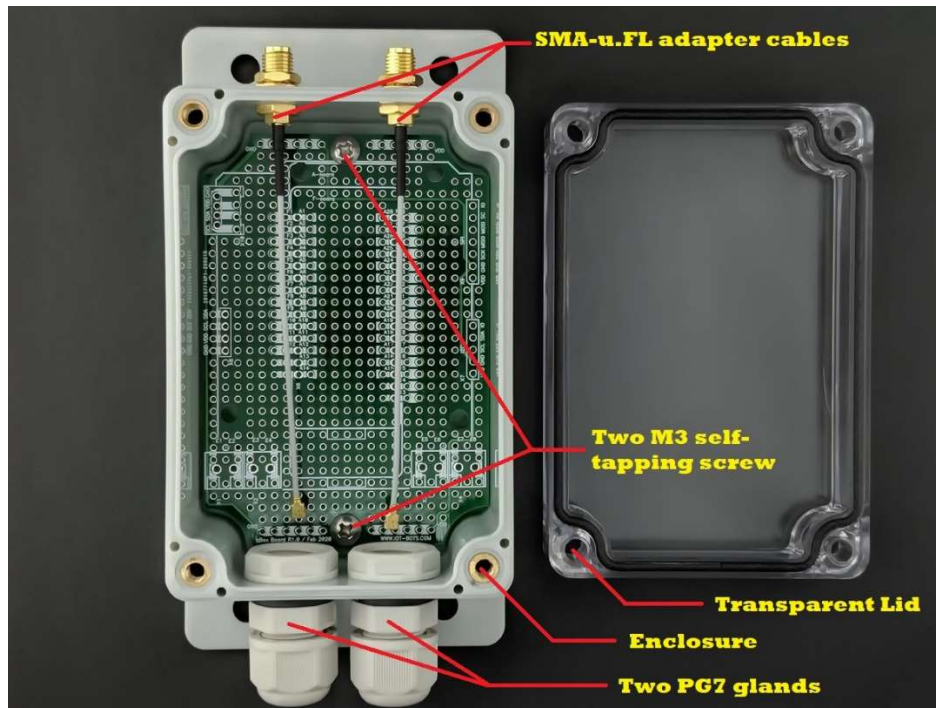

Pic.7. qBox Enclosure Plus Kit parts

External DC voltage from power adapter or solar system could be brought by cable through the one gland inner and another gland gives opportunity to connect external sensors or actuators.

Up to two (depending on kit type) GSM / LTE / WiFi / LoRa / etc. external antennas could be connected to wireless board u.FL PCB connector via SMA to IPEX (u.FL) adapter cables glued into enclosure wall.

Two M3 self-tapping screws securely attach the PCB to the enclosure. Same time board could be easily removed.

Enclosure has enough room to keep with or without stacking header one IOT controller board like Adafruit Feather Compatible (AFC) or Arduino MKR Compatible (AMC) or another IOT board, power supply (DC/DC), OLED display and sensor modules using plain grid proto holes.



Pic.8. qBox Enclosure Plus Kit with Arduino MKR Compatible (AMC) board installed



Pic.9. qBox Enclosure Plus Kit with Adafruit Feather Compatible (AFC) board installed

Up to four pluggable 3,5mm terminal blocks, one Grove and several DIP 0.1" I2C and SPI interface connectors could be populated. Two separate power traces for VDD and GND along short PCB sides allow bring the power to sensor boards.

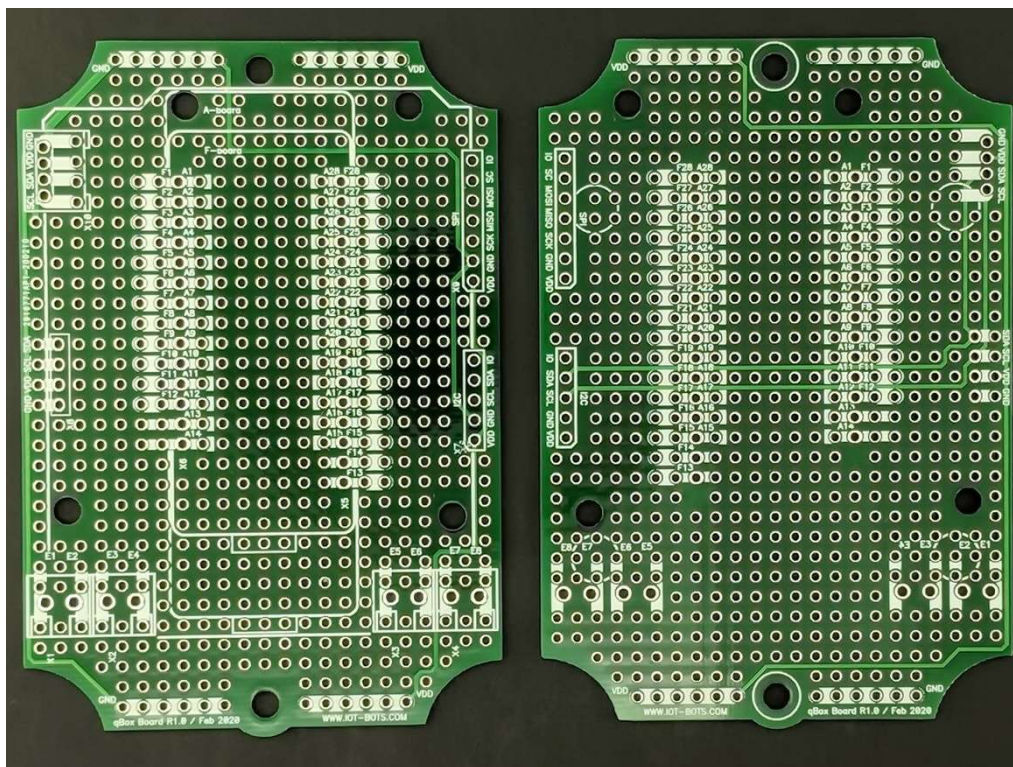

Pic.10. qBox Enclosure Plus Kit PCB common view (Front and Back)

Each connector pin has got a trace with DIP contacts that wires from other modules could be easily soldering.

There is example of connectors proposal:

- X1: External power connection through pluggable 3,5mm terminal block;
- X2...X4: External Input / Output sensor / actuator connections through pluggable 3,5mm terminal blocks;
- X5, X6: IOT board connectors could be located (0,1" DIP);
- X7: I2C sensors connector placement (0,1" DIP) with pins: VDD, GND, SCL, SDA, IO;
- X8: OLED I2C connector placement (0,1" DIP) with pins: VDD, GND, SCL, SDA;
- X9: SPI sensors connector placement (0,1" DIP) with pins: VDD, GND, SCK, MISO, MOSI, CS, IO;
- X10: "Grove" I2C connector placement (2,0 mm DIP) with pins: VDD, GND, SCL, SDA.

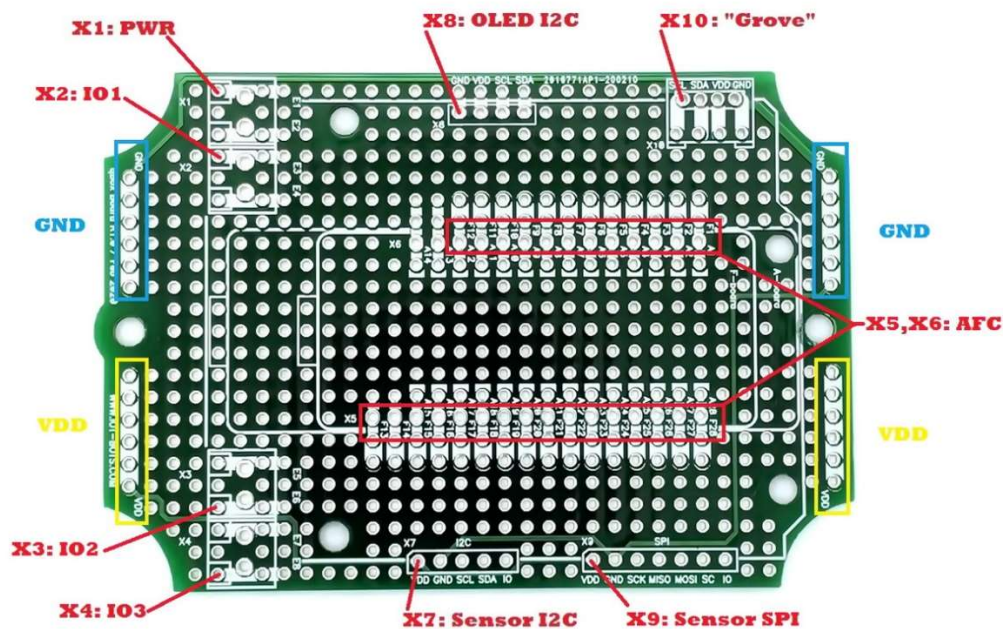

Pic.11. Connectors placement proposal: Adafruit Feather Compatible board based

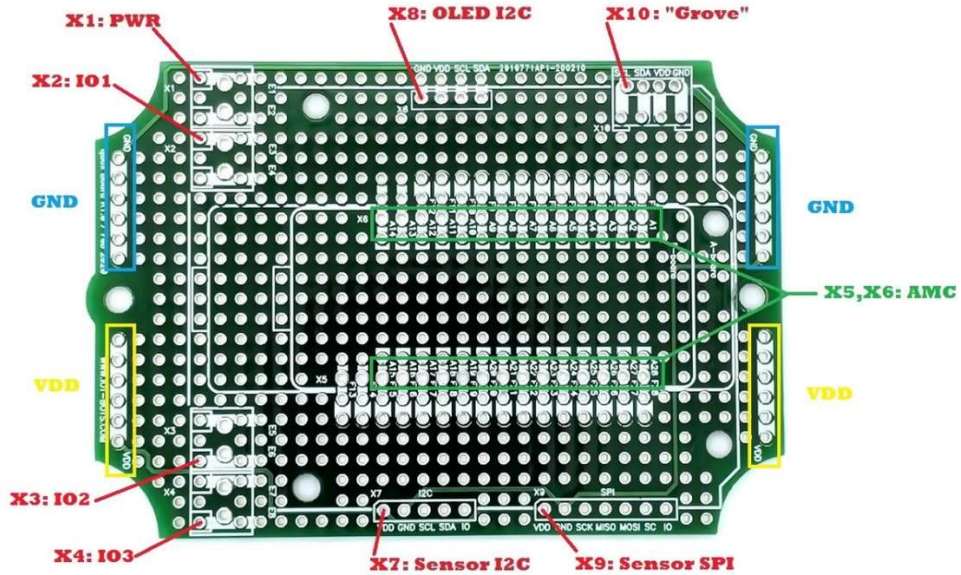

Pic.12. Connectors placement proposal: Arduino MKR Compatible board based

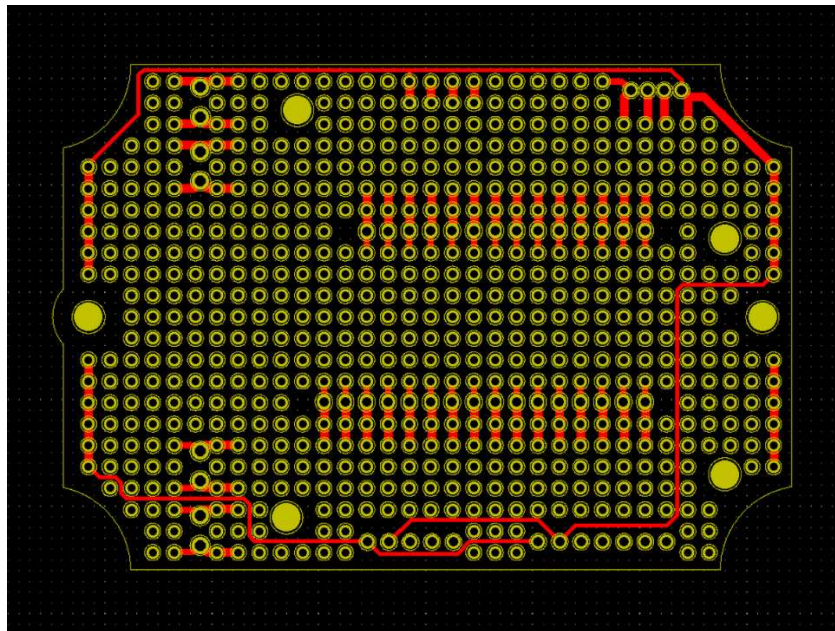

Pic.13. PCB Front Copper traces

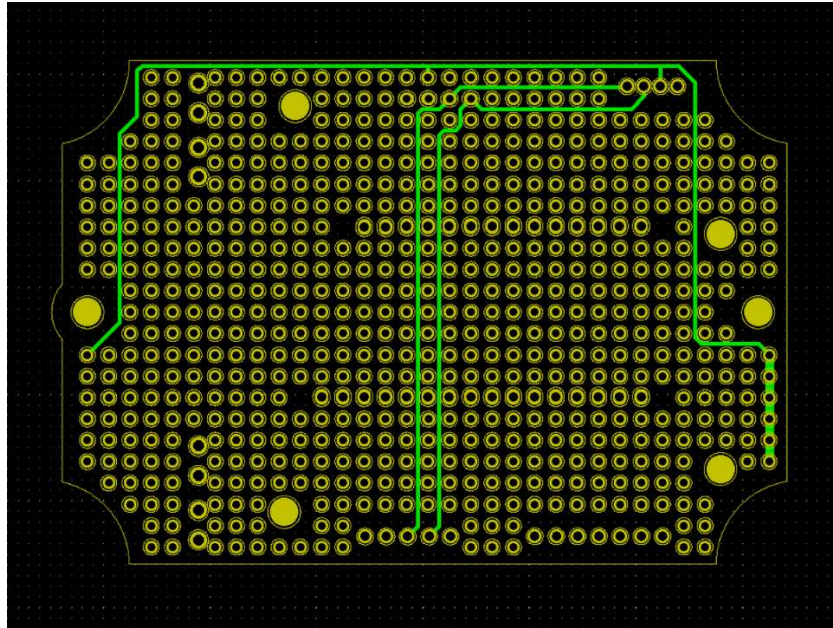

Pic.14. PCB Back Copper traces

IOT board connector pins have conditional names: A1...A28 for AMC boards, F1...F28 for AFC board.

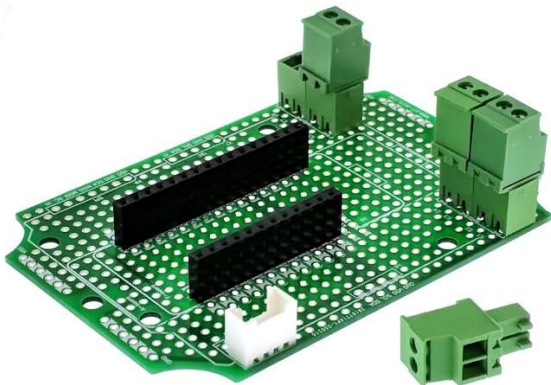

Pic.15. qBox Enclosure Plus Kit PCB with connectors setup for Adafruit Feather Compatible board

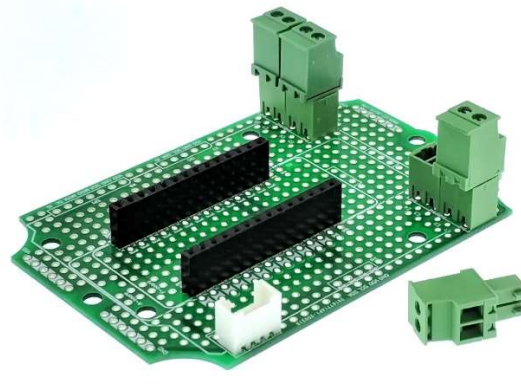

Pic.16. qBox Enclosure Plus Kit PCB with connectors setup for Arduino MKR Compatible board

qBoxMini Enclosure Plus Kits include connector set, that saves time and efforts for logistic and helps to build IOT device right out of the box.

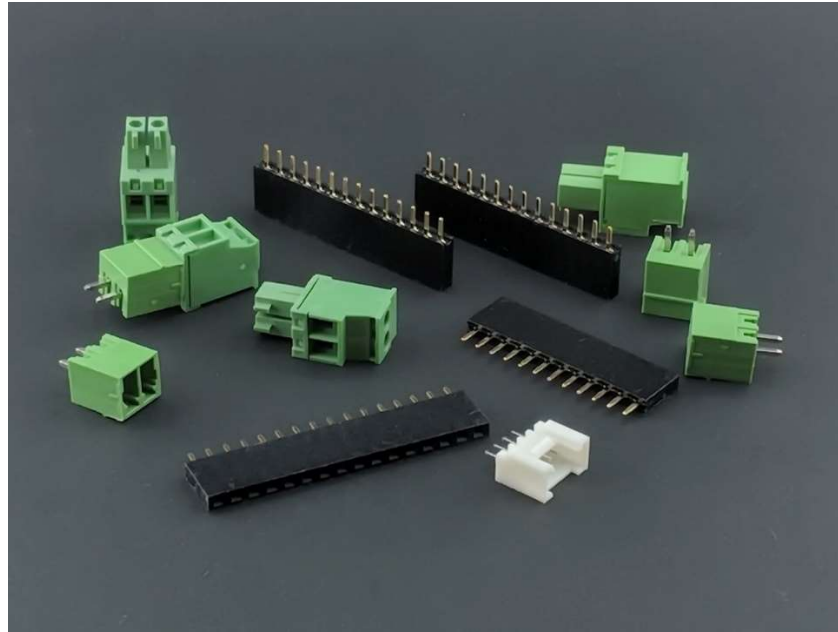

Pic.17. PCB Back Copper trace

Four additional holes and fasteners kit allow to mount Arduino Uno compatible board at the top of PCB.

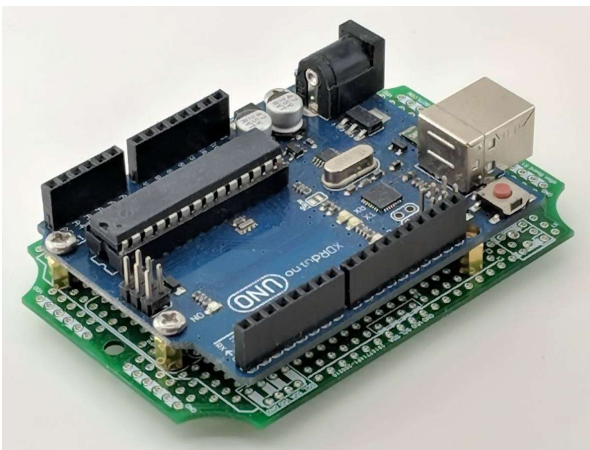

Pic.18. qBox Enclosure Plus Kit PCB with connectors setup for Adafruit Feather Compatible board



Pic.19. qBox Enclosure Plus Kit PCB with connectors setup for Adafruit for Arduino MKR Compatible board

Transparent lid allows to see internal parts, electronics, LEDs and even display and is able to hold LiPol battery or battery holder to be applied to the internal surface.

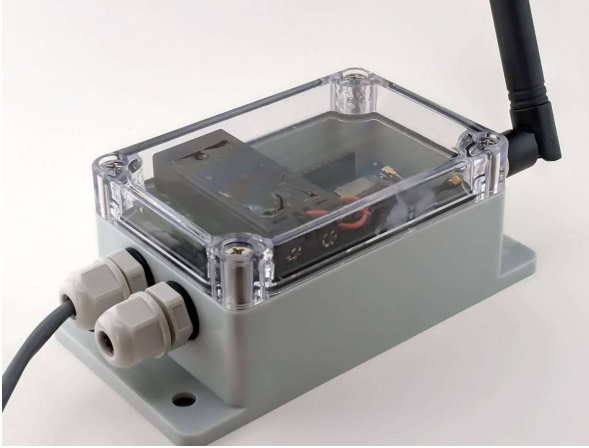

Pic. 20. 2xAAA battery holder applied to a transparent lid (assembled view)

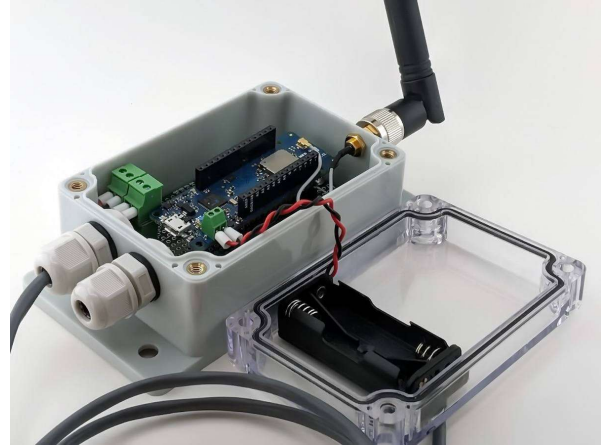

Pic. 21. 2xAAA battery holder applied to a transparent lid (inside view)

Specification

Housing Material: ABS

Water and Dust Proof: IP65

Enclosure Outer Size: 5.42"x2.72"x1.99" (L*W*H)

Enclosure Inner Size: 3.69"x2.42"x1.7" (L*W*H)

Gland model: PG7

Cables with diameters: 0.12-0.25"

PCB size: 3.46"x2.36"

Arduino UNO Compatible board fasteners kit:

- M3 brass hex standoff: 4 pcs
- M3 Stainless Steel Screw: 4 pcs
- M3 Stainless Steel Nuts: 4 pcs

Connectors set:

- Arduino MKR Compatible board female header set (two 0,1" pitch 1x14 pins connectors);
- Adafruit Feather Compatible board female header set (0,1" pitch 1x12 and 1x16 pins connectors);



- Four 3,5mm 2 pins terminal blocks with plugs;
- Seed Grove 2mm DIP connector.

qBox Enclosure Plus Kit content

- IP65 waterproof enclosure with two PG7 glands installed and up to two SMA u.FL adapter cables glued (depending on kit type);
- High quality prototyping double sided PCB mounted with two M3 self-tapping screws;
- Arduino UNO Compatible board fasteners kit;
- Connectors set (**connectors are NOT populated onto PCB**);
- Packaging bag and shipping box.

Project ideas

Using qBox Enclosure Plus Kits the variety of IOT DIY and POC projects could be done, like LoRa-based soil moisture monitoring project, home WiFi garage door opener, NB-IOT beehive monitoring system, GSM GPS asset tracking solution and many others.



Pic. 22. Arduino MKR LoRa controller



Pic. 23. WiFi ESP8266 No SMA project



Pic. 24. LTE GPS BG96 tracker with RS485 port



Pic. 25. Beehive LoRa monitoring system

Abbreviations

NoNo	Abbreviation	Explanation
1	AFC	Adafruit Feather Compatible
2	AMC	Arduino MKR Compatible

Trademark notice

All referenced brands, product names, service names, and trademarks are the property of their respective owners.

Ordering info

NoNo	Item	SKU
1	qBox DIY IOT Enclosure Plus Kit (No SMA)	IBT-QBX-CON-0
2	qBox DIY IOT Enclosure Plus Kit (One SMA)	IBT-QBX-CON-1
3	qBox DIY IOT Enclosure Plus Kit (Two SMAs)	IBT-QBX-CON-2