

X-LRQ-E Series Datasheet



- 75, 150, 300, 450, 600 mm travel
- Up to 840 mm/s speed and up to 300 N thrust
- 100 kg load capacity
- Ball screw and lead screw configurations
- Inline and parallel drive configurations
- Integrated, 500 CPR, motor mounted encoder provides slip/stall detection and recovery
- Built-in controller; daisy-chains with other Zaber products
- Custom versions available

X-LRQ-E Series Overview

Zaber's X-LRQ-E Series devices are computer-controlled, motorized linear stages with high stiffness, load, and lifetime capabilities in a compact size. Each device is available in either an inline or parallel drive configuration. They are stand-alone units requiring only a standard 24 V or 48 V power supply. The built-in motor encoder allows closed-loop operation and slip/stall recovery features. An optional indexed knob provides convenient manual control for versatile operation even without a computer.

These stages connect to the RS-232 port or USB port of any computer, and they can be daisy-chained with any other Zaber products. The daisy-chain also shares power, making it possible for multiple X-Series products to share a single power supply. Convenient locking, 4-pin, M8 connectors on the unit allow for secure connection between units.

At only 36 mm high, these stages are excellent for applications where a low profile is required. The X-LRQ-E's innovative design allows speeds up to 840 mm/s and loads up to 100 kg. Like all of Zaber's products, the X-LRQ-E Series is designed to be 'plug and play' and very easy to set up and operate. These stages can bolt together into XY and XYZ systems. Some multi axis configurations may require additional accessories, please contact Zaber Technical Support to ensure the correct ones are selected.

For more information visit: <https://www.zaber.com/products/linear-stages/X-LRQ-E>

X-LRQ-E Series Part Numbering & Options

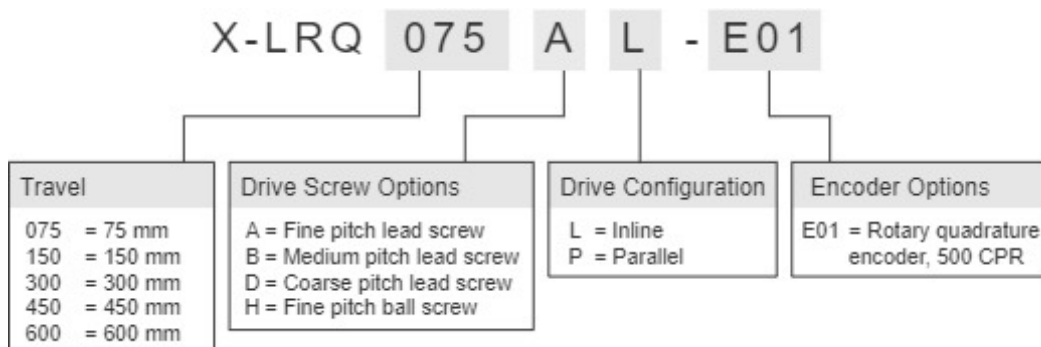

X-LRQ-E Series Drawings

ZABER

X-LRQxL-E Motorized Linear Stage
 dimensions in mm

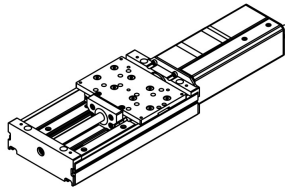

Model Number*	Travel	A	B
X-LRQ075xL-E	75.0	344.9	167.0
X-LRQ150xL-E	150.0	419.9	242.0
X-LRQ300xL-E	300.0	569.9	392.0
X-LRQ450xL-E	450.0	719.9	542.0
X-LRQ600xL-E	600.0	869.9	692.0

*See product page for complete list of available models at www.zaber.com

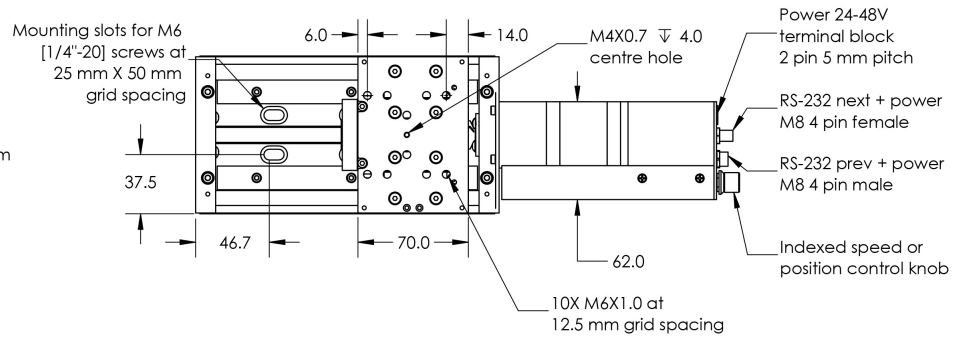

Recommended fastener for side T-slots: standard M2.5 nuts
 Note: Do not mount stage using these side T-slots. For accessories only

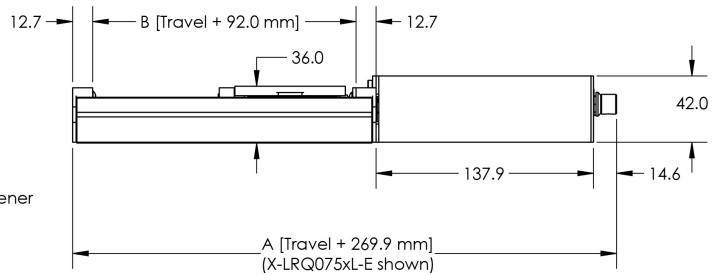
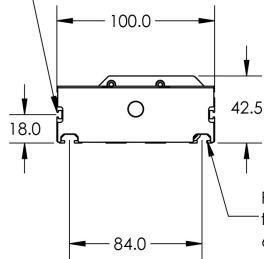

ZABER

X-LRQxP-E Motorized Linear Stage

dimensions in mm

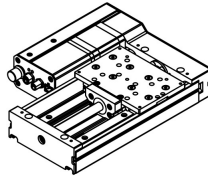

Model Number*	Travel	A	B
X-LRQ075xP-E	75.0	209.8	167.0
X-LRQ150xP-E	150.0	284.8	242.0
X-LRQ300xP-E	300.0	434.8	392.0
X-LRQ450xP-E	450.0	584.8	542.0
X-LRQ600xP-E	600.0	734.8	692.0

*See product page for complete list of available models at www.zaber.com

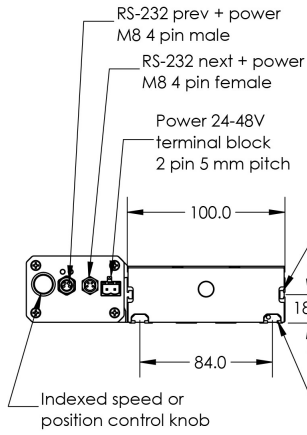

Recommended fastener
for side T-slots:
standard M2.5 nuts
Note: Do not mount stage
using these side T-slots.
For accessories only

Recommended fastener
for bottom T-slots:
6mm T-nuts

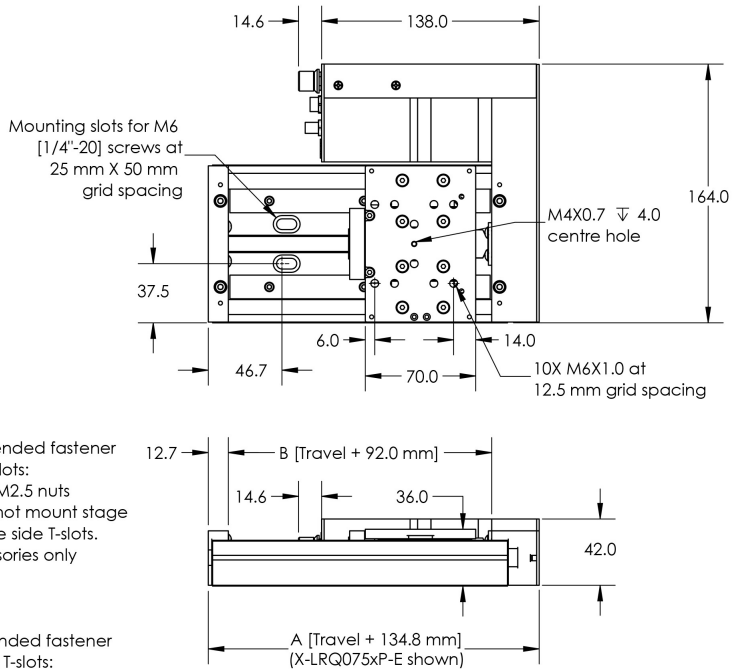

X-LRQ-E Series Specifications

Built-in Controller	
Encoder Resolution	500 CPR (2000 states/rev)
Encoder Type	Rotary quadrature encoder
Communication Interface	RS-232
Communication Protocol	Zaber ASCII (Default), Zaber Binary
Data Cable Connection	Locking 4-pin M8
Maximum Centered Load	1000 N (224.3 lb)
Maximum Cantilever Load	3000 N-cm (4248.4 oz-in)
Guide Type	Recirculating Ball Linear Guide
Stiffness in Pitch	640 N-m/° (27 µrad/N-m)
Stiffness in Roll	1850 N-m/° (9 µrad/N-m)
Stiffness in Yaw	665 N-m/° (26 µrad/N-m)
Power Supply	24-48 VDC
Power Plug	2-pin screw terminal
Maximum Current Draw	1900 mA
Motor Steps Per Rev	200
Motor Type	Stepper (2 phase)
Motor Rated Current	2300 mA/phase
Inductance	2.8 mH/phase
Default Resolution	1/64 of a step
Limit or Home Sensing	Magnetic home sensor
Manual Control	Indexed knob with push switch
Axes of Motion	1
LED Indicators	Yes
Mounting Interface	M6 and M3 threaded holes
Operating Temperature Range	0 to 50 °C
RoHS Compliant	Yes
CE Compliant	Yes
Vacuum Compatible	No

Part Number	Microstep Size (Default Resolution)	Travel Range	Accuracy (unidirectional)	Repeatability
X-LRQ075AL-E01	0.09921875 µm	75 mm (2.953")	23 µm (0.000906")	< 2.5 µm (< 0.000098")
X-LRQ075BL-E01	0.49609375 µm	75 mm (2.953")	15 µm (0.000591")	< 2.5 µm (< 0.000098")
X-LRQ075DL-E01	1.984375 µm	75 mm (2.953")	48 µm (0.001890")	< 3 µm (< 0.000118")
X-LRQ075HL-E01	0.1953125 µm	75 mm (2.953")	17.5 µm (0.000689")	< 5 µm (< 0.000197")
X-LRQ150AL-E01	0.09921875 µm	150 mm (5.905")	45 µm (0.001772")	< 2.5 µm (< 0.000098")
X-LRQ150BL-E01	0.49609375 µm	150 mm (5.905")	25 µm (0.000984")	< 2.5 µm (< 0.000098")
X-LRQ150DL-E01	1.984375 µm	150 mm (5.905")	55 µm (0.002165")	< 3 µm (< 0.000118")
X-LRQ150HL-E01	0.1953125 µm	150 mm (5.905")	30 µm (0.001181")	< 5 µm (< 0.000197")
X-LRQ300AL-E01	0.09921875 µm	300 mm (11.811")	90 µm (0.003543")	< 2.5 µm (< 0.000098")
X-LRQ300BL-E01	0.49609375 µm	300 mm (11.811")	35 µm (0.001378")	< 2.5 µm (< 0.000098")
X-LRQ300DL-E01	1.984375 µm	300 mm (11.811")	70 µm (0.002756")	< 3 µm (< 0.000118")
X-LRQ300HL-E01	0.1953125 µm	300 mm (11.811")	55 µm (0.002165")	< 5 µm (< 0.000197")
X-LRQ450AL-E01	0.09921875 µm	450 mm (17.716")	135 µm (0.005315")	< 2.5 µm (< 0.000098")
X-LRQ450BL-E01	0.49609375 µm	450 mm (17.716")	60 µm (0.002362")	< 2.5 µm (< 0.000098")
X-LRQ450DL-E01	1.984375 µm	450 mm (17.716")	85 µm (0.003346")	< 3 µm (< 0.000118")
X-LRQ450HL-E01	0.1953125 µm	450 mm (17.716")	85 µm (0.003346")	< 5 µm (< 0.000197")
X-LRQ600AL-E01	0.09921875 µm	600 mm (23.622")	150 µm (0.005905")	< 2.5 µm (< 0.000098")
X-LRQ600BL-E01	0.49609375 µm	600 mm (23.622")	90 µm (0.003543")	< 2.5 µm (< 0.000098")
X-LRQ600DL-E01	1.984375 µm	600 mm (23.622")	100 µm (0.003937")	< 3 µm (< 0.000118")
X-LRQ600HL-E01	0.1953125 µm	600 mm (23.622")	115 µm (0.004528")	< 5 µm (< 0.000197")
X-LRQ075AP-E01	0.09921875 µm	75 mm (2.953")	23 µm (0.000906")	< 2.5 µm (< 0.000098")
			15 µm	< 2.5 µm

Part Number	Microstep Size (Default Resolution)	Travel Range	Accuracy (unidirectional)	Repeatability
X-LRQ075BP-E01	0.49609375 µm	75 mm (2.953")	(0.000591")	(< 0.000098")
X-LRQ075DP-E01	1.984375 µm	75 mm (2.953")	48 µm (0.001890")	< 3 µm (< 0.000118")
X-LRQ075HP-E01	0.1953125 µm	75 mm (2.953")	27.5 µm (0.001083")	< 5 µm (< 0.000197")
X-LRQ150AP-E01	0.09921875 µm	150 mm (5.905")	45 µm (0.001772")	< 2.5 µm (< 0.000098")
X-LRQ150BP-E01	0.49609375 µm	150 mm (5.905")	25 µm (0.000984")	< 2.5 µm (< 0.000098")
X-LRQ150DP-E01	1.984375 µm	150 mm (5.905")	55 µm (0.002165")	< 3 µm (< 0.000118")
X-LRQ150HP-E01	0.1953125 µm	150 mm (5.905")	40 µm (0.001575")	< 5 µm (< 0.000197")
X-LRQ300AP-E01	0.09921875 µm	300 mm (11.811")	90 µm (0.003543")	< 2.5 µm (< 0.000098")
X-LRQ300BP-E01	0.49609375 µm	300 mm (11.811")	35 µm (0.001378")	< 2.5 µm (< 0.000098")
X-LRQ300DP-E01	1.984375 µm	300 mm (11.811")	70 µm (0.002756")	< 3 µm (< 0.000118")
X-LRQ300HP-E01	0.1953125 µm	300 mm (11.811")	65 µm (0.002559")	< 5 µm (< 0.000197")
X-LRQ450AP-E01	0.09921875 µm	450 mm (17.716")	135 µm (0.005315")	< 2.5 µm (< 0.000098")
X-LRQ450BP-E01	0.49609375 µm	450 mm (17.716")	60 µm (0.002362")	< 2.5 µm (< 0.000098")
X-LRQ450DP-E01	1.984375 µm	450 mm (17.716")	85 µm (0.003346")	< 3 µm (< 0.000118")
X-LRQ450HP-E01	0.1953125 µm	450 mm (17.716")	95 µm (0.003740")	< 5 µm (< 0.000197")
X-LRQ600AP-E01	0.09921875 µm	600 mm (23.622")	150 µm (0.005905")	< 2.5 µm (< 0.000098")
X-LRQ600BP-E01	0.49609375 µm	600 mm (23.622")	90 µm (0.003543")	< 2.5 µm (< 0.000098")
X-LRQ600DP-E01	1.984375 µm	600 mm (23.622")	100 µm (0.003937")	< 3 µm (< 0.000118")
X-LRQ600HP-E01	0.1953125 µm	600 mm (23.622")	125 µm (0.004921")	< 5 µm (< 0.000197")

Part Number	Backlash	Maximum Speed	Minimum Speed	Speed Resolution
-------------	----------	---------------	---------------	------------------

Part Number	Backlash	Maximum Speed	Minimum Speed	Speed Resolution
X-LRQ075AL-E01	< 8 μm (< 0.000315")	54 mm/s (2.126"/s)	0.000061 mm/s (0.000002"/s)	0.000061 mm/s (0.000002"/s)
X-LRQ075BL-E01	< 21 μm (< 0.000827")	270 mm/s (10.630"/s)	0.000303 mm/s (0.000012"/s)	0.000303 mm/s (0.000012"/s)
X-LRQ075DL-E01	< 60 μm (< 0.002362")	840 mm/s (33.071"/s)	0.001212 mm/s (0.000048"/s)	0.001212 mm/s (0.000048"/s)
X-LRQ075HL-E01	< 30 μm (< 0.001181")	110 mm/s (4.331"/s)	0.000119 mm/s (0.000005"/s)	0.000119 mm/s (0.000005"/s)
X-LRQ150AL-E01	< 8 μm (< 0.000315")	54 mm/s (2.126"/s)	0.000061 mm/s (0.000002"/s)	0.000061 mm/s (0.000002"/s)
X-LRQ150BL-E01	< 21 μm (< 0.000827")	270 mm/s (10.630"/s)	0.000303 mm/s (0.000012"/s)	0.000303 mm/s (0.000012"/s)
X-LRQ150DL-E01	< 60 μm (< 0.002362")	840 mm/s (33.071"/s)	0.001212 mm/s (0.000048"/s)	0.001212 mm/s (0.000048"/s)
X-LRQ150HL-E01	< 30 μm (< 0.001181")	110 mm/s (4.331"/s)	0.000119 mm/s (0.000005"/s)	0.000119 mm/s (0.000005"/s)
X-LRQ300AL-E01	< 8 μm (< 0.000315")	54 mm/s (2.126"/s)	0.000061 mm/s (0.000002"/s)	0.000061 mm/s (0.000002"/s)
X-LRQ300BL-E01	< 21 μm (< 0.000827")	270 mm/s (10.630"/s)	0.000303 mm/s (0.000012"/s)	0.000303 mm/s (0.000012"/s)
X-LRQ300DL-E01	< 60 μm (< 0.002362")	840 mm/s (33.071"/s)	0.001212 mm/s (0.000048"/s)	0.001212 mm/s (0.000048"/s)
X-LRQ300HL-E01	< 30 μm (< 0.001181")	110 mm/s (4.331"/s)	0.000119 mm/s (0.000005"/s)	0.000119 mm/s (0.000005"/s)
X-LRQ450AL-E01	< 8 μm (< 0.000315")	54 mm/s (2.126"/s)	0.000061 mm/s (0.000002"/s)	0.000061 mm/s (0.000002"/s)
X-LRQ450BL-E01	< 21 μm (< 0.000827")	270 mm/s (10.630"/s)	0.000303 mm/s (0.000012"/s)	0.000303 mm/s (0.000012"/s)
X-LRQ450DL-E01	< 60 μm (< 0.002362")	840 mm/s (33.071"/s)	0.001212 mm/s (0.000048"/s)	0.001212 mm/s (0.000048"/s)
X-LRQ450HL-E01	< 30 μm (< 0.001181")	110 mm/s (4.331"/s)	0.000119 mm/s (0.000005"/s)	0.000119 mm/s (0.000005"/s)
X-LRQ600AL-E01	< 8 μm (< 0.000315")	54 mm/s (2.126"/s)	0.000061 mm/s (0.000002"/s)	0.000061 mm/s (0.000002"/s)
X-LRQ600BL-E01	< 21 μm (< 0.000827")	270 mm/s (10.630"/s)	0.000303 mm/s (0.000012"/s)	0.000303 mm/s (0.000012"/s)
X-LRQ600DL-E01	< 60 μm (< 0.002362")	840 mm/s (33.071"/s)	0.001212 mm/s (0.000048"/s)	0.001212 mm/s (0.000048"/s)
X-LRQ600HL-E01	< 30 μm (< 0.001181")	110 mm/s (4.331"/s)	0.000119 mm/s (0.000005"/s)	0.000119 mm/s (0.000005"/s)
X-LRQ075AP-E01	< 14 μm (< 0.000551")	54 mm/s (2.126"/s)	0.000061 mm/s (0.000002"/s)	0.000061 mm/s (0.000002"/s)

Part Number	Backlash	Maximum Speed	Minimum Speed	Speed Resolution
X-LRQ075BP-E01	< 27 μm (< 0.001063")	270 mm/s (10.630"/s)	0.000303 mm/s (0.000012"/s)	0.000303 mm/s (0.000012"/s)
X-LRQ075DP-E01	< 66 μm (< 0.002598")	840 mm/s (33.071"/s)	0.001212 mm/s (0.000048"/s)	0.001212 mm/s (0.000048"/s)
X-LRQ075HP-E01	< 30 μm (< 0.001181")	110 mm/s (4.331"/s)	0.000119 mm/s (0.000005"/s)	0.000119 mm/s (0.000005"/s)
X-LRQ150AP-E01	< 14 μm (< 0.000551")	54 mm/s (2.126"/s)	0.000061 mm/s (0.000002"/s)	0.000061 mm/s (0.000002"/s)
X-LRQ150BP-E01	< 27 μm (< 0.001063")	270 mm/s (10.630"/s)	0.000303 mm/s (0.000012"/s)	0.000303 mm/s (0.000012"/s)
X-LRQ150DP-E01	< 66 μm (< 0.002598")	840 mm/s (33.071"/s)	0.001212 mm/s (0.000048"/s)	0.001212 mm/s (0.000048"/s)
X-LRQ150HP-E01	< 30 μm (< 0.001181")	110 mm/s (4.331"/s)	0.000119 mm/s (0.000005"/s)	0.000119 mm/s (0.000005"/s)
X-LRQ300AP-E01	< 14 μm (< 0.000551")	54 mm/s (2.126"/s)	0.000061 mm/s (0.000002"/s)	0.000061 mm/s (0.000002"/s)
X-LRQ300BP-E01	< 27 μm (< 0.001063")	270 mm/s (10.630"/s)	0.000303 mm/s (0.000012"/s)	0.000303 mm/s (0.000012"/s)
X-LRQ300DP-E01	< 66 μm (< 0.002598")	840 mm/s (33.071"/s)	0.001212 mm/s (0.000048"/s)	0.001212 mm/s (0.000048"/s)
X-LRQ300HP-E01	< 30 μm (< 0.001181")	110 mm/s (4.331"/s)	0.000119 mm/s (0.000005"/s)	0.000119 mm/s (0.000005"/s)
X-LRQ450AP-E01	< 14 μm (< 0.000551")	54 mm/s (2.126"/s)	0.000061 mm/s (0.000002"/s)	0.000061 mm/s (0.000002"/s)
X-LRQ450BP-E01	< 27 μm (< 0.001063")	270 mm/s (10.630"/s)	0.000303 mm/s (0.000012"/s)	0.000303 mm/s (0.000012"/s)
X-LRQ450DP-E01	< 66 μm (< 0.002598")	840 mm/s (33.071"/s)	0.001212 mm/s (0.000048"/s)	0.001212 mm/s (0.000048"/s)
X-LRQ450HP-E01	< 30 μm (< 0.001181")	110 mm/s (4.331"/s)	0.000119 mm/s (0.000005"/s)	0.000119 mm/s (0.000005"/s)
X-LRQ600AP-E01	< 14 μm (< 0.000551")	54 mm/s (2.126"/s)	0.000061 mm/s (0.000002"/s)	0.000061 mm/s (0.000002"/s)
X-LRQ600BP-E01	< 27 μm (< 0.001063")	270 mm/s (10.630"/s)	0.000303 mm/s (0.000012"/s)	0.000303 mm/s (0.000012"/s)
X-LRQ600DP-E01	< 66 μm (< 0.002598")	840 mm/s (33.071"/s)	0.001212 mm/s (0.000048"/s)	0.001212 mm/s (0.000048"/s)
X-LRQ600HP-E01	< 30 μm (< 0.001181")	110 mm/s (4.331"/s)	0.000119 mm/s (0.000005"/s)	0.000119 mm/s (0.000005"/s)

Part Number	Peak Thrust	Back-driving Force	Maximum Continuous Thrust	Vertical Runout
				< 20 μm

Part Number	Peak Thrust	Back-driving Force	Maximum Continuous Thrust	Vertical Runout
X-LRQ075AL-E01	230 N (51.6 lb)	Non-back-driving	100 N (22.4 lb)	(< 0.000787")
X-LRQ075BL-E01	150 N (33.6 lb)	(± 30%) 93 N (20.9 lb)	100 N (22.4 lb)	< 20 µm (< 0.000787")
X-LRQ075DL-E01	35 N (7.8 lb)	(± 30%) 14 N (3.1 lb)	25 N (5.6 lb)	< 20 µm (< 0.000787")
X-LRQ075HL-E01	500 N (112.1 lb)	(± 30%) 93 N (20.9 lb)	200 N (44.9 lb)	< 20 µm (< 0.000787")
X-LRQ150AL-E01	230 N (51.6 lb)	Non-back-driving	100 N (22.4 lb)	< 25 µm (< 0.000984")
X-LRQ150BL-E01	150 N (33.6 lb)	(± 30%) 93 N (20.9 lb)	100 N (22.4 lb)	< 25 µm (< 0.000984")
X-LRQ150DL-E01	35 N (7.8 lb)	(± 30%) 14 N (3.1 lb)	25 N (5.6 lb)	< 25 µm (< 0.000984")
X-LRQ150HL-E01	500 N (112.1 lb)	(± 30%) 93 N (20.9 lb)	200 N (44.9 lb)	< 25 µm (< 0.000984")
X-LRQ300AL-E01	230 N (51.6 lb)	Non-back-driving	100 N (22.4 lb)	< 35 µm (< 0.001378")
X-LRQ300BL-E01	150 N (33.6 lb)	(± 30%) 93 N (20.9 lb)	100 N (22.4 lb)	< 35 µm (< 0.001378")
X-LRQ300DL-E01	35 N (7.8 lb)	(± 30%) 14 N (3.1 lb)	25 N (5.6 lb)	< 35 µm (< 0.001378")
X-LRQ300HL-E01	500 N (112.1 lb)	(± 30%) 93 N (20.9 lb)	200 N (44.9 lb)	< 35 µm (< 0.001378")
X-LRQ450AL-E01	230 N (51.6 lb)	Non-back-driving	100 N (22.4 lb)	< 45 µm (< 0.001772")
X-LRQ450BL-E01	150 N (33.6 lb)	(± 30%) 93 N (20.9 lb)	100 N (22.4 lb)	< 45 µm (< 0.001772")
X-LRQ450DL-E01	35 N (7.8 lb)	(± 30%) 14 N (3.1 lb)	25 N (5.6 lb)	< 45 µm (< 0.001772")
X-LRQ450HL-E01	500 N (112.1 lb)	(± 30%) 93 N (20.9 lb)	200 N (44.9 lb)	< 45 µm (< 0.001772")
X-LRQ600AL-E01	230 N (51.6 lb)	Non-back-driving	100 N (22.4 lb)	< 75 µm (< 0.002953")
X-LRQ600BL-E01	150 N (33.6 lb)	(± 30%) 93 N (20.9 lb)	100 N (22.4 lb)	< 75 µm (< 0.002953")
X-LRQ600DL-E01	35 N (7.8 lb)	(± 30%) 14 N (3.1 lb)	25 N (5.6 lb)	< 75 µm (< 0.002953")
X-LRQ600HL-E01	500 N (112.1 lb)	(± 30%) 93 N (20.9 lb)	200 N (44.9 lb)	< 75 µm (< 0.002953")
X-LRQ075AP-E01	230 N (51.6 lb)	Non-back-driving	100 N (22.4 lb)	< 20 µm (< 0.000787")

Part Number	Peak Thrust	Back-driving Force	Maximum Continuous Thrust	Vertical Runout
X-LRQ075BP-E01	150 N (33.6 lb)	(± 30%) 123 N (27.6 lb)	100 N (22.4 lb)	< 20 µm (< 0.000787")
X-LRQ075DP-E01	35 N (7.8 lb)	(± 30%) 45 N (10.1 lb)	25 N (5.6 lb)	< 20 µm (< 0.000787")
X-LRQ075HP-E01	500 N (112.1 lb)	(± 30%) 123 N (27.6 lb)	200 N (44.9 lb)	< 20 µm (< 0.000787")
X-LRQ150AP-E01	230 N (51.6 lb)	Non-back-driving	100 N (22.4 lb)	< 25 µm (< 0.000984")
X-LRQ150BP-E01	150 N (33.6 lb)	(± 30%) 123 N (27.6 lb)	100 N (22.4 lb)	< 25 µm (< 0.000984")
X-LRQ150DP-E01	35 N (7.8 lb)	(± 30%) 45 N (10.1 lb)	25 N (5.6 lb)	< 25 µm (< 0.000984")
X-LRQ150HP-E01	500 N (112.1 lb)	(± 30%) 123 N (27.6 lb)	200 N (44.9 lb)	< 25 µm (< 0.000984")
X-LRQ300AP-E01	230 N (51.6 lb)	Non-back-driving	100 N (22.4 lb)	< 35 µm (< 0.001378")
X-LRQ300BP-E01	150 N (33.6 lb)	(± 30%) 123 N (27.6 lb)	100 N (22.4 lb)	< 35 µm (< 0.001378")
X-LRQ300DP-E01	35 N (7.8 lb)	(± 30%) 45 N (10.1 lb)	25 N (5.6 lb)	< 35 µm (< 0.001378")
X-LRQ300HP-E01	500 N (112.1 lb)	(± 30%) 123 N (27.6 lb)	200 N (44.9 lb)	< 35 µm (< 0.001378")
X-LRQ450AP-E01	230 N (51.6 lb)	Non-back-driving	100 N (22.4 lb)	< 45 µm (< 0.001772")
X-LRQ450BP-E01	150 N (33.6 lb)	(± 30%) 123 N (27.6 lb)	100 N (22.4 lb)	< 45 µm (< 0.001772")
X-LRQ450DP-E01	35 N (7.8 lb)	(± 30%) 45 N (10.1 lb)	25 N (5.6 lb)	< 45 µm (< 0.001772")
X-LRQ450HP-E01	500 N (112.1 lb)	(± 30%) 123 N (27.6 lb)	200 N (44.9 lb)	< 45 µm (< 0.001772")
X-LRQ600AP-E01	230 N (51.6 lb)	Non-back-driving	100 N (22.4 lb)	< 75 µm (< 0.002953")
X-LRQ600BP-E01	150 N (33.6 lb)	(± 30%) 123 N (27.6 lb)	100 N (22.4 lb)	< 75 µm (< 0.002953")
X-LRQ600DP-E01	35 N (7.8 lb)	(± 30%) 45 N (10.1 lb)	25 N (5.6 lb)	< 75 µm (< 0.002953")
X-LRQ600HP-E01	500 N (112.1 lb)	(± 30%) 123 N (27.6 lb)	200 N (44.9 lb)	< 75 µm (< 0.002953")

Part Number	Horizontal Runout	Pitch	Roll	Yaw
	< 20 µm	0.025°	0.01°	0.02°

Part Number	Horizontal Runout	Pitch	Roll	Yaw
X-LRQ075AL-E01	(< 0.000787")	(0.436 mrad)	(0.174 mrad)	(0.349 mrad)
X-LRQ075BL-E01	< 20 µm (< 0.000787")	0.025° (0.436 mrad)	0.01° (0.174 mrad)	0.02° (0.349 mrad)
X-LRQ075DL-E01	< 20 µm (< 0.000787")	0.025° (0.436 mrad)	0.01° (0.174 mrad)	0.02° (0.349 mrad)
X-LRQ075HL-E01	< 20 µm (< 0.000787")	0.025° (0.436 mrad)	0.01° (0.174 mrad)	0.02° (0.349 mrad)
X-LRQ150AL-E01	< 20 µm (< 0.000787")	0.03° (0.523 mrad)	0.015° (0.262 mrad)	0.02° (0.349 mrad)
X-LRQ150BL-E01	< 20 µm (< 0.000787")	0.03° (0.523 mrad)	0.015° (0.262 mrad)	0.02° (0.349 mrad)
X-LRQ150DL-E01	< 20 µm (< 0.000787")	0.03° (0.523 mrad)	0.015° (0.262 mrad)	0.02° (0.349 mrad)
X-LRQ150HL-E01	< 20 µm (< 0.000787")	0.03° (0.523 mrad)	0.015° (0.262 mrad)	0.02° (0.349 mrad)
X-LRQ300AL-E01	< 30 µm (< 0.001181")	0.034° (0.593 mrad)	0.015° (0.262 mrad)	0.03° (0.523 mrad)
X-LRQ300BL-E01	< 30 µm (< 0.001181")	0.034° (0.593 mrad)	0.015° (0.262 mrad)	0.03° (0.523 mrad)
X-LRQ300DL-E01	< 30 µm (< 0.001181")	0.034° (0.593 mrad)	0.015° (0.262 mrad)	0.03° (0.523 mrad)
X-LRQ300HL-E01	< 30 µm (< 0.001181")	0.034° (0.593 mrad)	0.015° (0.262 mrad)	0.03° (0.523 mrad)
X-LRQ450AL-E01	< 40 µm (< 0.001575")	0.04° (0.698 mrad)	0.025° (0.436 mrad)	0.04° (0.698 mrad)
X-LRQ450BL-E01	< 40 µm (< 0.001575")	0.04° (0.698 mrad)	0.025° (0.436 mrad)	0.04° (0.698 mrad)
X-LRQ450DL-E01	< 40 µm (< 0.001575")	0.04° (0.698 mrad)	0.025° (0.436 mrad)	0.04° (0.698 mrad)
X-LRQ450HL-E01	< 40 µm (< 0.001575")	0.04° (0.698 mrad)	0.025° (0.436 mrad)	0.04° (0.698 mrad)
X-LRQ600AL-E01	< 60 µm (< 0.002362")	0.045° (0.785 mrad)	0.035° (0.611 mrad)	0.04° (0.698 mrad)
X-LRQ600BL-E01	< 60 µm (< 0.002362")	0.045° (0.785 mrad)	0.035° (0.611 mrad)	0.04° (0.698 mrad)
X-LRQ600DL-E01	< 60 µm (< 0.002362")	0.045° (0.785 mrad)	0.035° (0.611 mrad)	0.04° (0.698 mrad)
X-LRQ600HL-E01	< 60 µm (< 0.002362")	0.045° (0.785 mrad)	0.035° (0.611 mrad)	0.04° (0.698 mrad)
X-LRQ075AP-E01	< 20 µm (< 0.000787")	0.025° (0.436 mrad)	0.01° (0.174 mrad)	0.02° (0.349 mrad)
X-LRQ075BP-E01	< 20 µm	0.025°	0.01°	0.02°

Part Number	Horizontal Runout	Pitch	Roll	Yaw
	(< 0.000787")	(0.436 mrad)	(0.174 mrad)	(0.349 mrad)
X-LRQ075DP-E01	< 20 µm (< 0.000787")	0.025° (0.436 mrad)	0.01° (0.174 mrad)	0.02° (0.349 mrad)
X-LRQ075HP-E01	< 20 µm (< 0.000787")	0.025° (0.436 mrad)	0.01° (0.174 mrad)	0.02° (0.349 mrad)
X-LRQ150AP-E01	< 20 µm (< 0.000787")	0.03° (0.523 mrad)	0.015° (0.262 mrad)	0.02° (0.349 mrad)
X-LRQ150BP-E01	< 20 µm (< 0.000787")	0.03° (0.523 mrad)	0.015° (0.262 mrad)	0.02° (0.349 mrad)
X-LRQ150DP-E01	< 20 µm (< 0.000787")	0.03° (0.523 mrad)	0.015° (0.262 mrad)	0.02° (0.349 mrad)
X-LRQ150HP-E01	< 20 µm (< 0.000787")	0.03° (0.523 mrad)	0.015° (0.262 mrad)	0.02° (0.349 mrad)
X-LRQ300AP-E01	< 30 µm (< 0.001181")	0.034° (0.593 mrad)	0.015° (0.262 mrad)	0.03° (0.523 mrad)
X-LRQ300BP-E01	< 30 µm (< 0.001181")	0.034° (0.593 mrad)	0.015° (0.262 mrad)	0.03° (0.523 mrad)
X-LRQ300DP-E01	< 30 µm (< 0.001181")	0.034° (0.593 mrad)	0.015° (0.262 mrad)	0.03° (0.523 mrad)
X-LRQ300HP-E01	< 30 µm (< 0.001181")	0.034° (0.593 mrad)	0.015° (0.262 mrad)	0.03° (0.523 mrad)
X-LRQ450AP-E01	< 40 µm (< 0.001575")	0.04° (0.698 mrad)	0.025° (0.436 mrad)	0.04° (0.698 mrad)
X-LRQ450BP-E01	< 40 µm (< 0.001575")	0.04° (0.698 mrad)	0.025° (0.436 mrad)	0.04° (0.698 mrad)
X-LRQ450DP-E01	< 40 µm (< 0.001575")	0.04° (0.698 mrad)	0.025° (0.436 mrad)	0.04° (0.698 mrad)
X-LRQ450HP-E01	< 40 µm (< 0.001575")	0.04° (0.698 mrad)	0.025° (0.436 mrad)	0.04° (0.698 mrad)
X-LRQ600AP-E01	< 60 µm (< 0.002362")	0.045° (0.785 mrad)	0.035° (0.611 mrad)	0.04° (0.698 mrad)
X-LRQ600BP-E01	< 60 µm (< 0.002362")	0.045° (0.785 mrad)	0.035° (0.611 mrad)	0.04° (0.698 mrad)
X-LRQ600DP-E01	< 60 µm (< 0.002362")	0.045° (0.785 mrad)	0.035° (0.611 mrad)	0.04° (0.698 mrad)
X-LRQ600HP-E01	< 60 µm (< 0.002362")	0.045° (0.785 mrad)	0.035° (0.611 mrad)	0.04° (0.698 mrad)

Part Number	Linear Motion Per Motor Rev	Mechanical Drive System	Weight
X-LRQ075AL-E01	1.27 mm (0.050")	Precision lead screw	2.19 kg (4.828 lb)

Part Number	Linear Motion Per Motor Rev	Mechanical Drive System	Weight
X-LRQ075BL-E01	6.35 mm (0.250")	Precision lead screw	2.19 kg (4.828 lb)
X-LRQ075DL-E01	25.4 mm (1.000")	Precision lead screw	2.19 kg (4.828 lb)
X-LRQ075HL-E01	2.5 mm (0.098")	Precision ball screw	2.19 kg (4.828 lb)
X-LRQ150AL-E01	1.27 mm (0.050")	Precision lead screw	2.56 kg (5.644 lb)
X-LRQ150BL-E01	6.35 mm (0.250")	Precision lead screw	2.56 kg (5.644 lb)
X-LRQ150DL-E01	25.4 mm (1.000")	Precision lead screw	2.56 kg (5.644 lb)
X-LRQ150HL-E01	2.5 mm (0.098")	Precision ball screw	2.56 kg (5.644 lb)
X-LRQ300AL-E01	1.27 mm (0.050")	Precision lead screw	3.32 kg (7.319 lb)
X-LRQ300BL-E01	6.35 mm (0.250")	Precision lead screw	3.32 kg (7.319 lb)
X-LRQ300DL-E01	25.4 mm (1.000")	Precision lead screw	3.32 kg (7.319 lb)
X-LRQ300HL-E01	2.5 mm (0.098")	Precision ball screw	3.32 kg (7.319 lb)
X-LRQ450AL-E01	1.27 mm (0.050")	Precision lead screw	4.07 kg (8.973 lb)
X-LRQ450BL-E01	6.35 mm (0.250")	Precision lead screw	4.07 kg (8.973 lb)
X-LRQ450DL-E01	25.4 mm (1.000")	Precision lead screw	4.07 kg (8.973 lb)
X-LRQ450HL-E01	2.5 mm (0.098")	Precision ball screw	4.07 kg (8.973 lb)
X-LRQ600AL-E01	1.27 mm (0.050")	Precision lead screw	4.78 kg (10.538 lb)
X-LRQ600BL-E01	6.35 mm (0.250")	Precision lead screw	4.78 kg (10.538 lb)
X-LRQ600DL-E01	25.4 mm (1.000")	Precision lead screw	4.78 kg (10.538 lb)
X-LRQ600HL-E01	2.5 mm (0.098")	Precision ball screw	4.78 kg (10.538 lb)
X-LRQ075AP-E01	1.27 mm (0.050")	Precision lead screw	2.33 kg (5.137 lb)
X-LRQ075BP-E01	6.35 mm (0.250")	Precision lead screw	2.33 kg (5.137 lb)
X-LRQ075DP-E01	25.4 mm (1.000")	Precision lead screw	2.33 kg (5.137 lb)
X-LRQ075HP-E01	2.5 mm (0.098")	Precision ball screw	2.33 kg (5.137 lb)
X-LRQ150AP-E01	1.27 mm (0.050")	Precision lead screw	2.70 kg (5.952 lb)
X-LRQ150BP-E01	6.35 mm (0.250")	Precision lead screw	2.70 kg (5.952 lb)
X-LRQ150DP-E01	25.4 mm (1.000")	Precision lead screw	2.70 kg (5.952 lb)
X-LRQ150HP-E01	2.5 mm (0.098")	Precision ball screw	2.70 kg (5.952 lb)
X-LRQ300AP-E01	1.27 mm (0.050")	Precision lead screw	3.46 kg (7.628 lb)
X-LRQ300BP-E01	6.35 mm (0.250")	Precision lead screw	3.46 kg (7.628 lb)
X-LRQ300DP-E01	25.4 mm (1.000")	Precision lead screw	3.46 kg (7.628 lb)
X-LRQ300HP-E01	2.5 mm (0.098")	Precision ball screw	3.46 kg (7.628 lb)
X-LRQ450AP-E01	1.27 mm (0.050")	Precision lead screw	4.21 kg (9.281 lb)
X-LRQ450BP-E01	6.35 mm (0.250")	Precision lead screw	4.21 kg (9.281 lb)

Part Number	Linear Motion Per Motor Rev	Mechanical Drive System	Weight
X-LRQ450DP-E01	25.4 mm (1.000")	Precision lead screw	4.21 kg (9.281 lb)
X-LRQ450HP-E01	2.5 mm (0.098")	Precision ball screw	4.21 kg (9.281 lb)
X-LRQ600AP-E01	1.27 mm (0.050")	Precision lead screw	4.92 kg (10.847 lb)
X-LRQ600BP-E01	6.35 mm (0.250")	Precision lead screw	4.92 kg (10.847 lb)
X-LRQ600DP-E01	25.4 mm (1.000")	Precision lead screw	4.92 kg (10.847 lb)
X-LRQ600HP-E01	2.5 mm (0.098")	Precision ball screw	4.92 kg (10.847 lb)

X-LRQ-E Series Charts

Thrust Speed Performance

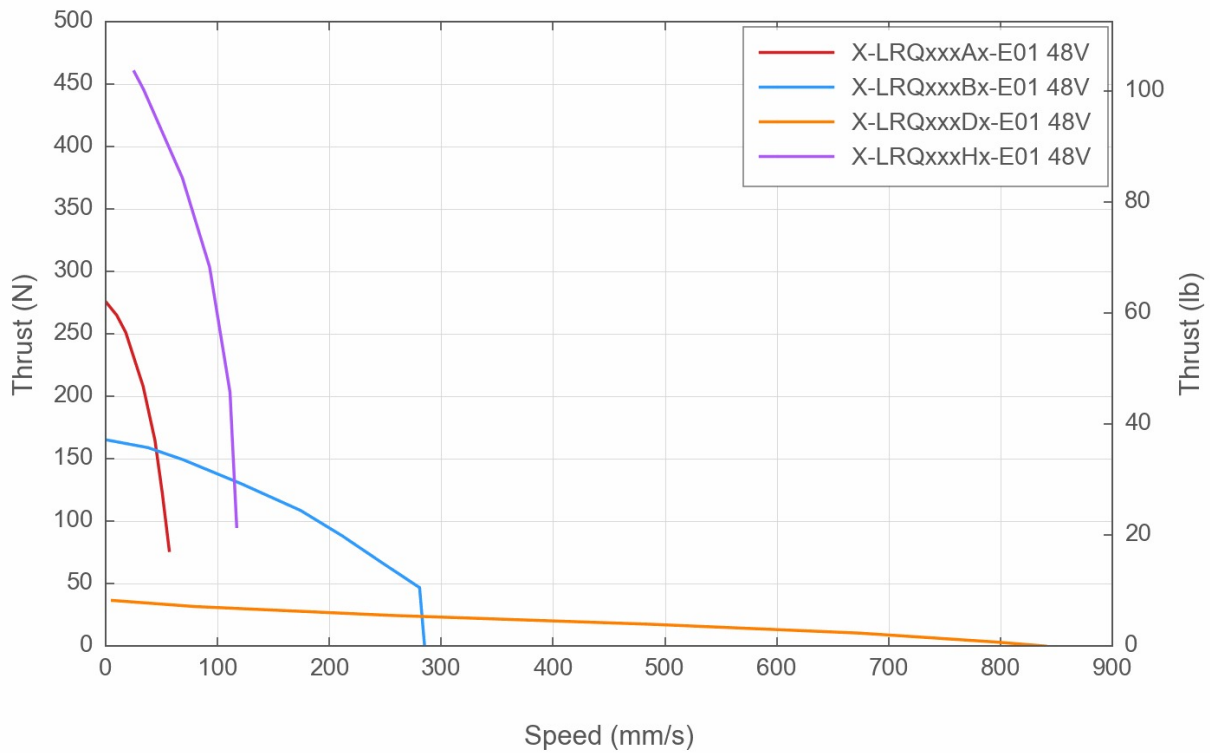

Thrust Speed Performance

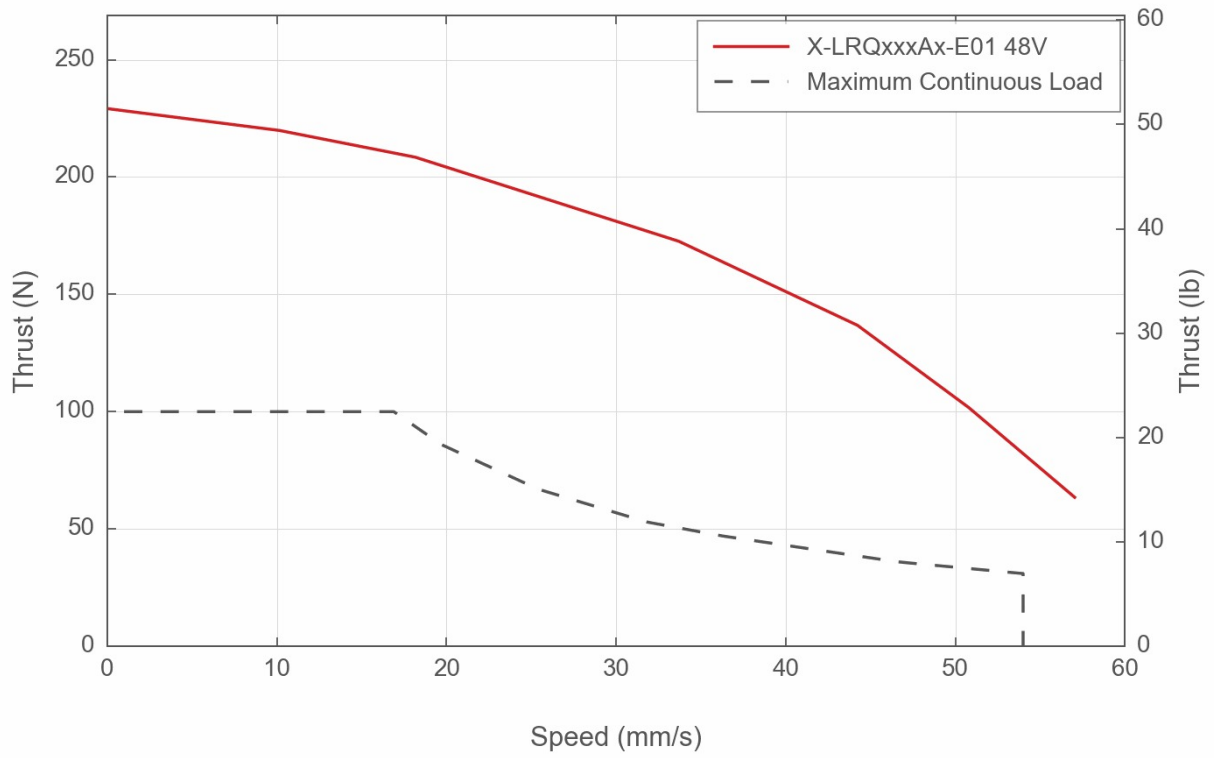

Thrust Speed Performance

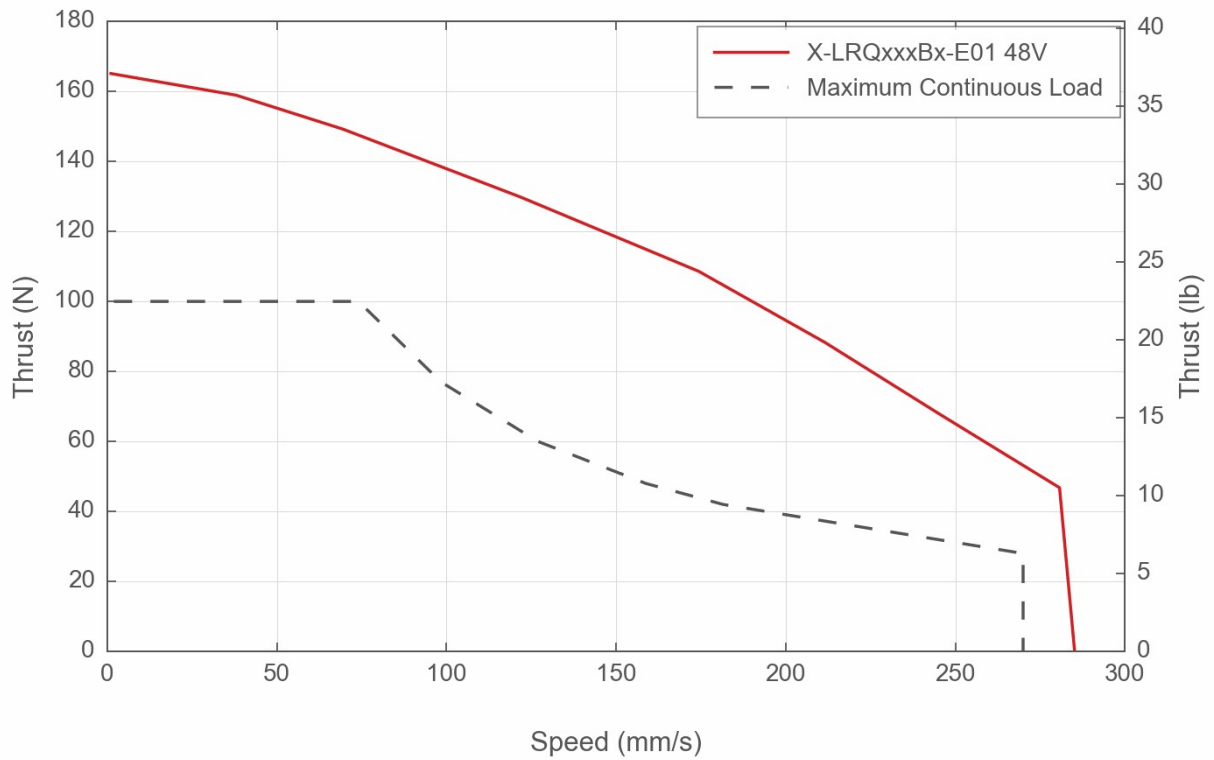

Thrust Speed Performance

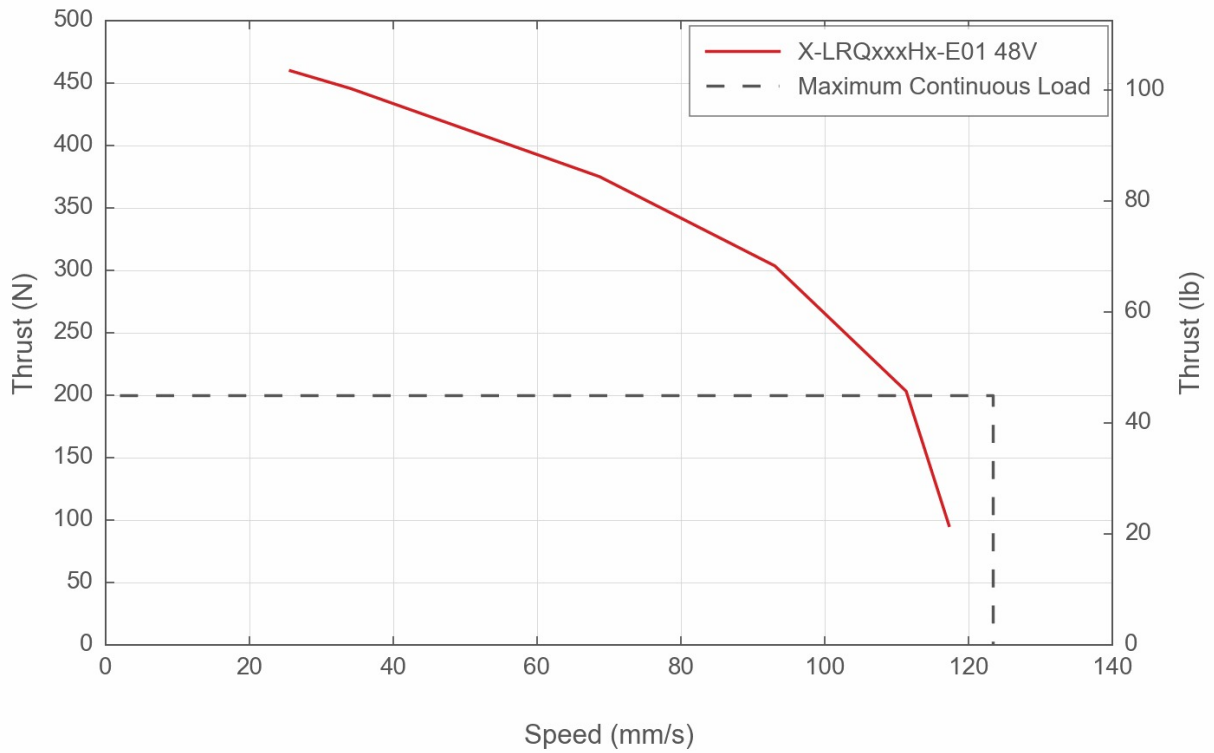

LRQ Linear Bearing Lifetime

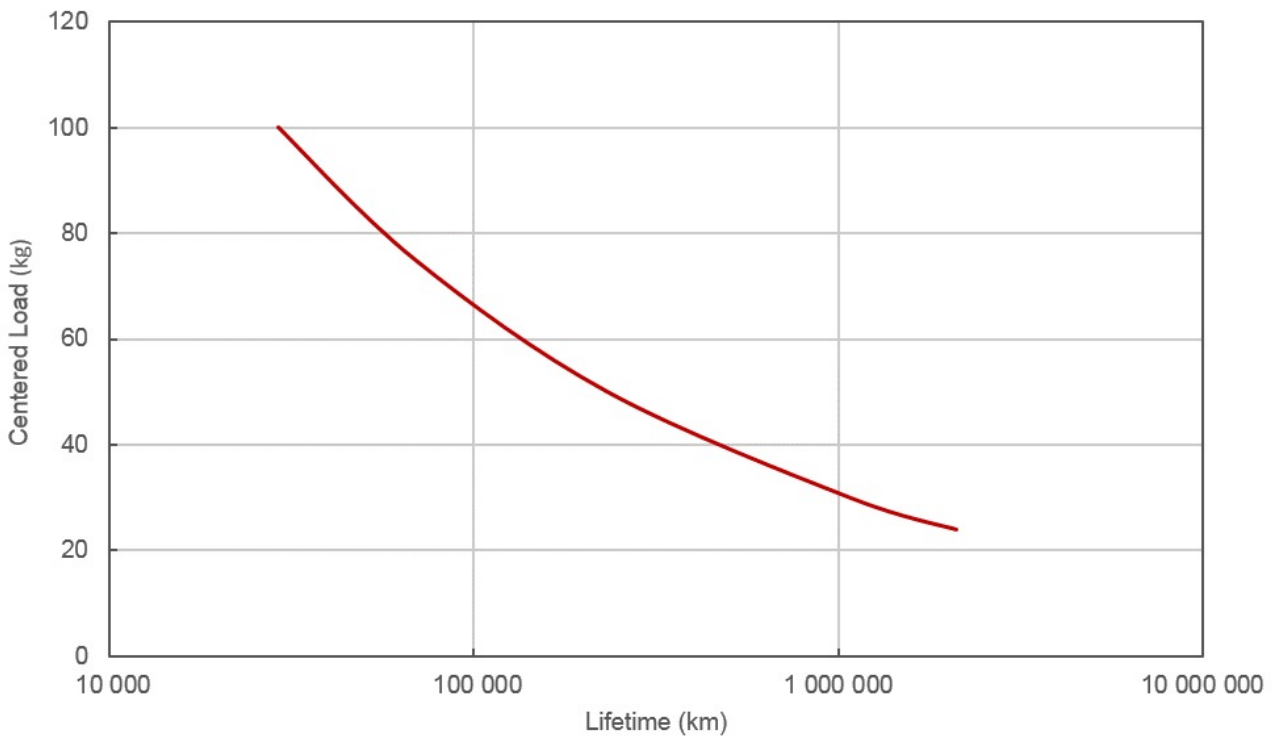

Thrust Speed Performance

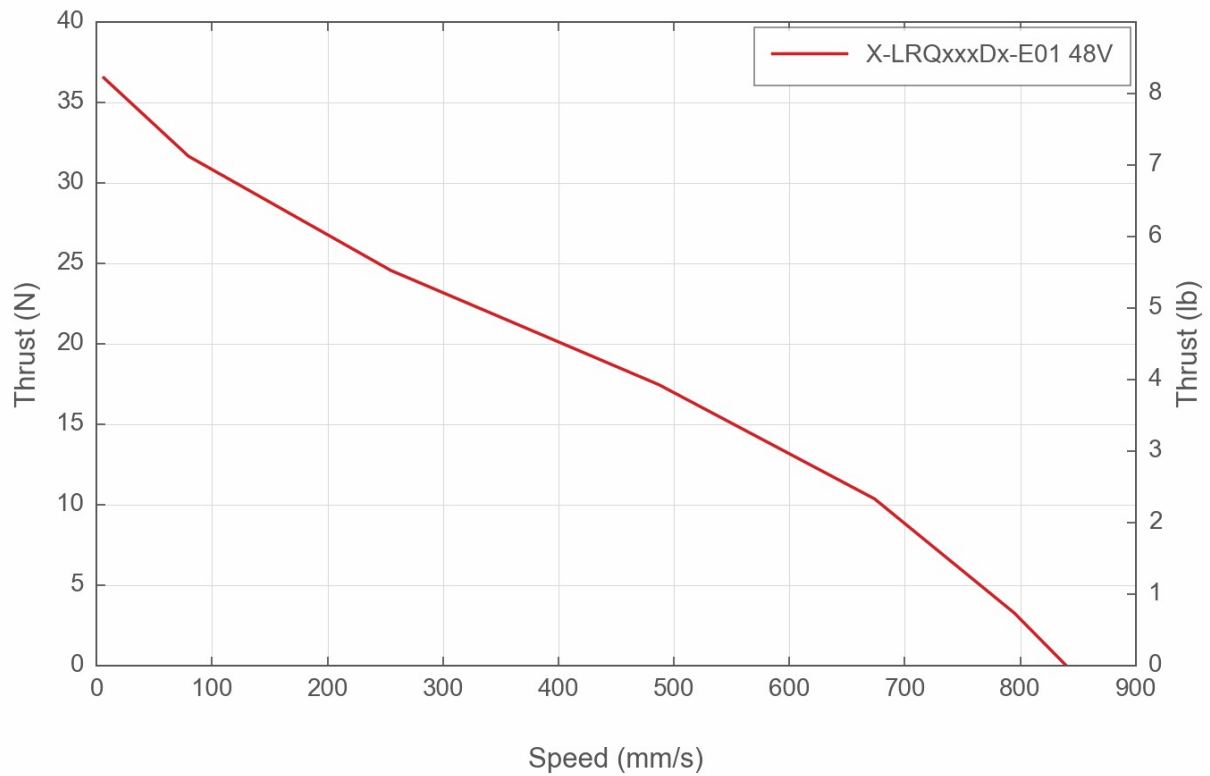

Contact

Email: contact@zaber.com

Phone (toll free Canada/USA): 1-888-276-8033

Phone (direct): 1-604-569-3780

Fax: 1-604-648-8033

Zaber Technologies Inc.

#2 - 605 West Kent Ave. N.

Vancouver, British Columbia

Canada, V6P 6T7

<https://www.zaber.com>