

1-1825006-3 ✓ ACTIVE

Alcoswitch | Alcoswitch DIP, Alcoswitch DIP GDS

TE Internal #: 1-1825006-3

DIP & SIP Switches, Gold, Black, Polyphenylene Sulfide (PPS), Sealed Device, 8 Switch, -30 - 85 °C, DIP, Slide Actuator Style, Alcoswitch DIP

[View on TE.com >](#)



Switches > DIP & SIP Switches

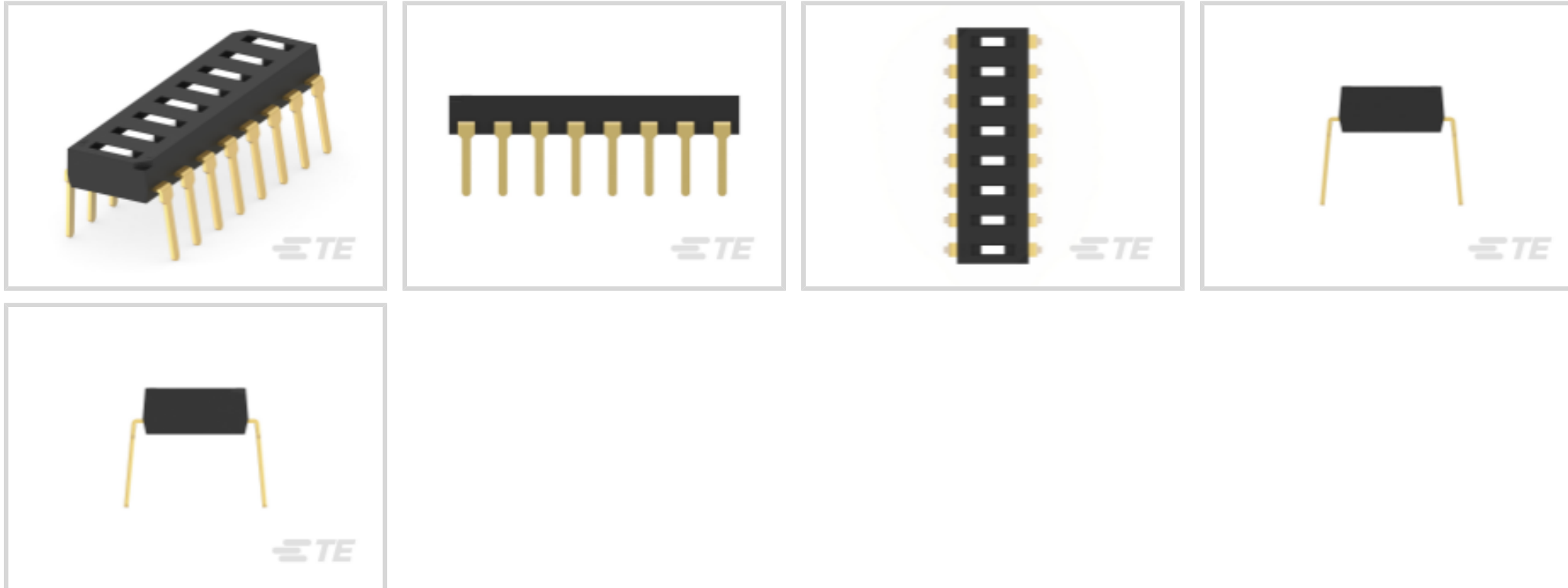

Switch Contact Plating Material: **Gold**

Case Color: **Black**

Case Material: **Polyphenylene Sulfide (PPS)**

Sealed Device: **Yes**

Number of Switches: **8**

Features

Product Type Features

Sealed Device	Yes
DIP & SIP Switch Type	DIP
Actuator Style	Slide

Configuration Features

Number of Positions	8
Number of Switches	8
Configuration (Pole-Throw)	Single Pole - Single Throw

Electrical Characteristics

Contact Current Rating	.1 A
Operating Voltage	50 VDC

Body Features

Actuator Color	White
Sealing Method	Sealing Tape
Product Orientation	Vertical



Case Color	Black
Case Material	Polyphenylene Sulfide (PPS)

Contact Features

	10 µin
Contact Underplating Material	Nickel
PCB Contact Termination Area Plating Material	Gold
Switch Contact Plating Material	Gold
Contact Base Material	Copper Alloy

Termination Features

Termination Post & Tail Length	4.3 mm[.169 in]
Termination Method to Printed Circuit Board	Through Hole - Solder

Housing Features

Low Profile	Yes
Centerline (Pitch)	2.54 mm[.1 in]

Dimensions

Product Length	20.17 mm[.794 in]
Product Height	2.7 mm[.106 in]

Usage Conditions

Operating Temperature Range	-30 - 85 °C
-----------------------------	-------------

Operation/Application

Assembly Process Feature	Auto-Insert Packaging
--------------------------	-----------------------

Industry Standards

UL Flammability Rating	UL 94V-0
------------------------	----------

Packaging Features

Packaging Quantity	20
Packaging Method	Tube

Product Compliance

[For compliance documentation, visit the product page on TE.com>](#)

EU RoHS Directive 2011/65/EU	Compliant
EU ELV Directive 2000/53/EC	Compliant



China RoHS 2 Directive MIIT Order No 32, 2016	No Restricted Materials Above Threshold
EU REACH Regulation (EC) No. 1907/2006	Current ECHA Candidate List: JAN 2024 (240) Candidate List Declared Against: JAN 2024 (240) Does not contain REACH SVHC
Halogen Content	Low Halogen - Br, Cl, F, I < 900 ppm per homogenous material. Also BFR/CFR/PVC Free
Solder Process Capability	Wave solder capable to 265°C

Product Compliance Disclaimer

This information is provided based on reasonable inquiry of our suppliers and represents our current actual knowledge based on the information they provided. This information is subject to change. The part numbers that TE has identified as EU RoHS compliant have a maximum concentration of 0.1% by weight in homogenous materials for lead, hexavalent chromium, mercury, PBB, PBDE, DBP, BBP, DEHP, DIBP, and 0.01% for cadmium, or qualify for an exemption to these limits as defined in the Annexes of Directive 2011/65/EU (RoHS2). Finished electrical and electronic equipment products will be CE marked as required by Directive 2011/65/EU. Components may not be CE marked. Additionally, the part numbers that TE has identified as EU ELV compliant have a maximum concentration of 0.1% by weight in homogenous materials for lead, hexavalent chromium, and mercury, and 0.01% for cadmium, or qualify for an exemption to these limits as defined in the Annexes of Directive 2000/53/EC (ELV). Regarding the REACH Regulation, the information TE provides on SVHC in articles for this part number is based on the latest European Chemicals Agency (ECHA) 'Guidance on requirements for substances in articles' posted at this URL: <https://echa.europa.eu/guidance-documents/guidance-on-reach>

Compatible Parts



TE Part # 1825006-7
GDS04S04=DIP SW,SLIDE,SMT



TE Part # 1825006-3
GDS02S04=DIP SW,SLIDE,SMT



TE Part # 1-1825006-5
GDS08S04=DIP SW,SLIDE,SMT



TE Part # 1-1825006-2
GDS06STR04=DIP SW,SLIDE,SMT,TR



TE Part # 1-1825006-6
GDS08STR04=DIP SW,SLIDE,SMT,TR

Also in the Series | [Alcoswitch DIP](#)

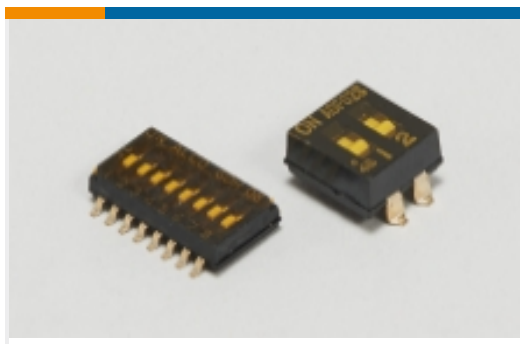

DIP & SIP Switches(185)



Rotary Switches(16)

Also in the Series | Alcoswitch DIP GDS

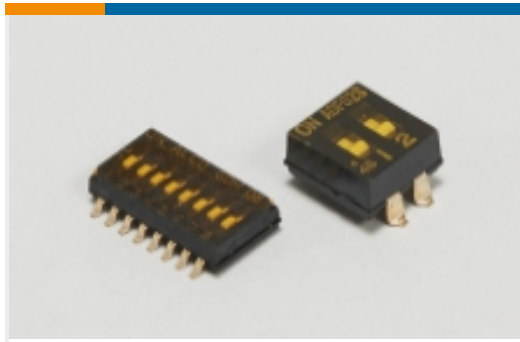

DIP & SIP Switches(15)

Customers Also Bought

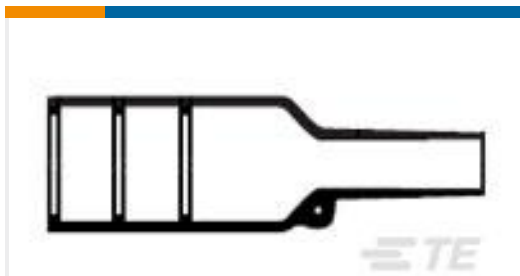

TE Part # 878497-000
202K153-25-0

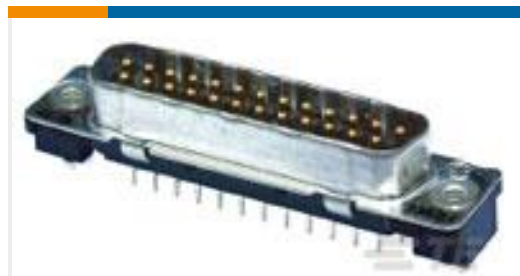

TE Part # 3-338310-2
15POS.HD20 PLUG ASS'Y

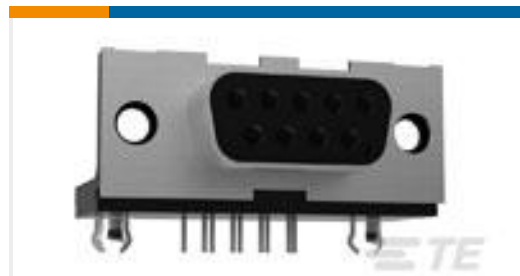

TE Part # 1-106505-2
9P.HDP20 REC.ASSY.

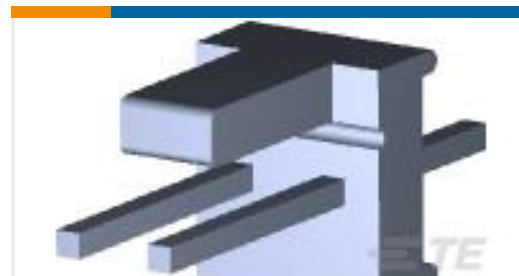

TE Part # 640454-2
02P MTA100 HDR ASSY SQ STR POL



TE Part # 5069824023
CGPT-3.2/1.6-0-SP



TE Part # 794894-1
02P MINI UMNL PLUGS WIRE HOLES



TE Part # 1825057-3
ADE0404=DIP SWITCH,EXT,THRU/HL



TE Part # 350825-1
03P UMNL HDR ASSY PC 94VO

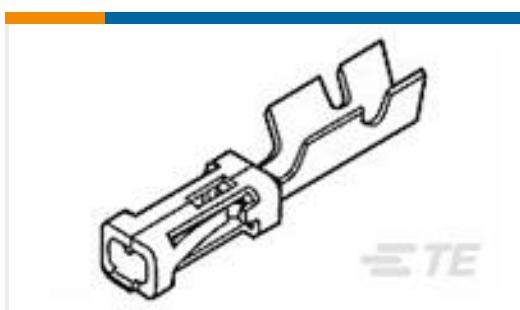

TE Part # 87046-4
MOD IV RECP LP



TE Part # 3518793001
55A0111-18-45



Documents

Product Drawings

[GDS0804=DIP SW,SLIDE,THRU/HL](#)

English

CAD Files

Customer View Model

[ENG_CVM_CVM_1-1825006-3_O.2d_dxf.zip](#)

English

3D PDF

3D

Customer View Model

[ENG_CVM_CVM_1-1825006-3_O.3d_igs.zip](#)

English

Customer View Model

[ENG_CVM_CVM_1-1825006-3_O.3d_stp.zip](#)

English

By downloading the CAD file I accept and agree to the [Terms and Conditions](#) of use.

Datasheets & Catalog Pages

[SWITCHES_CORE_PROGRAM_CATALOG](#)

English