

5.0 kV rms Dual Channel Digital Isolators

FEATURES

- ▶ High common-mode transient immunity: 100 kV/μs
- ▶ High robustness to radiated and conducted noise
- ▶ Low propagation delay: 13 ns maximum for 5 V operation, 15 ns maximum for 1.8 V operation
- ▶ 150 Mbps maximum data rate
- ▶ [Safety and regulatory approvals](#)
 - ▶ UL recognition: 5000 V rms for 1 minute per UL 1577
 - ▶ CSA certification per IEC 62368-1, IEC 61010-1, and IEC 60601-1
 - ▶ VDE certificate of conformity
 - ▶ DIN V VDE V 0884-10 (VDE V 0884-10):2006-12
 - ▶ $V_{IORM} = 849$ V peak
 - ▶ 10,000 V peak surge/impulse voltage rating
 - ▶ CQC Certification per GB4943.1-2011
- ▶ Low dynamic power consumption
- ▶ 1.8 V to 5 V level translation
- ▶ High temperature operation: 125°C maximum
- ▶ Fail-safe high or low options
- ▶ [8-lead/16-lead, RoHS compliant SOIC packages](#)
- ▶ AEC-Q100 qualified for automotive applications

APPLICATIONS

- ▶ General-purpose multichannel isolation
- ▶ Industrial field bus isolation
- ▶ Automotive systems

GENERAL DESCRIPTION

The ADuM220N/ADuM221N/ADuM225N/ADuM226N¹ are dual-channel digital isolators based on Analog Devices, Inc., *iCoupler*® technology. Combining high speed, complementary metal-oxide semiconductor (CMOS) and monolithic air core transformer technology, these isolation components provide outstanding performance characteristics superior to alternatives such as optocoupler devices and other integrated couplers. The maximum propagation delay is 13 ns with a pulse width distortion (PWD) of less than 3 ns at 5 V operation. Channel matching is tight at 3.0 ns maximum.

The ADuM220N/ADuM221N/ADuM225N/ADuM226N data channels are independent and are available in a variety of configurations with a withstand voltage rating of 5.0 kV rms (see the [Ordering Guide](#)). The devices operate with the supply voltage on either side ranging from 1.8 V to 5 V, providing compatibility with lower voltage systems as well as enabling voltage translation functionality across the isolation barrier. Unlike other optocoupler alternatives, dc correctness is ensured in the absence of input logic transitions. Two different fail-safe options are available, in which the outputs transition to a predetermined state when the input power supply is not applied or the inputs are disabled. The ADuM220N0 is pin compatible with the [ADuM2210](#) RW-16 package. The ADuM220N1 is pin compatible with the [ADuM2200](#) RW-16 package. The ADuM221N0 is pin compatible with the [ADuM2211](#) RW-16 package. The ADuM221N1 is pin compatible with the [ADuM2201](#) RW-16 package.

¹ Protected by U.S. Patents 5,952,849; 6,873,065; 6,903,578; and 7,075,329. Other patents are pending.

TABLE OF CONTENTS

| | | | |
|--|----|---|----|
| Features..... | 1 | Maximum Continuous Working Voltage..... | 14 |
| Applications..... | 1 | Truth Table..... | 15 |
| General Description..... | 1 | Pin Configurations and Function Descriptions..... | 16 |
| Functional Block Diagrams..... | 3 | Typical Performance Characteristics..... | 19 |
| Specifications..... | 4 | Theory of Operation..... | 20 |
| Electrical Characteristics—5 V Operation..... | 4 | Overview..... | 20 |
| Electrical Characteristics—3.3 V Operation..... | 5 | Applications Information..... | 21 |
| Electrical Characteristics—2.5 V Operation..... | 7 | PCB Layout..... | 21 |
| Electrical Characteristics—1.8 V Operation..... | 8 | Propagation Delay Related Parameters..... | 21 |
| Insulation and Safety Related Specifications... .. | 10 | Jitter Measurement..... | 21 |
| Package Characteristics..... | 11 | Insulation Lifetime..... | 21 |
| Regulatory Information..... | 11 | Outline Dimensions..... | 24 |
| DIN V VDE V 0884-10 (VDE V 0884-10) | | Ordering Guide..... | 25 |
| Insulation Characteristics..... | 12 | No. of Inputs, V_{DD1} and V_{DD2} Side Options..... | 25 |
| Recommended Operating Conditions..... | 13 | Withstand Voltage Rating (kV rms) and Fail-Safe Output State Options..... | 26 |
| Absolute Maximum Ratings..... | 14 | Automotive Products..... | 26 |
| ESD Caution..... | 14 | | |

REVISION HISTORY**12/2023—Rev. B to Rev. C**

| | |
|---|----|
| Changes to Features Section..... | 1 |
| Changes to Table 13..... | 11 |
| Changes to Table 14..... | 12 |
| Added No. of Inputs, V_{DD1} and V_{DD2} Side Options Section..... | 25 |
| Added Withstand Voltage Rating (kV rms) and Fail-Safe Output State Options Section..... | 26 |

FUNCTIONAL BLOCK DIAGRAMS

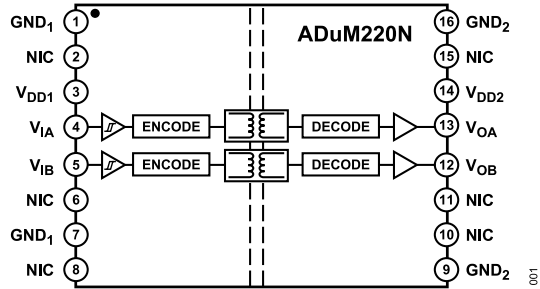

Figure 1.

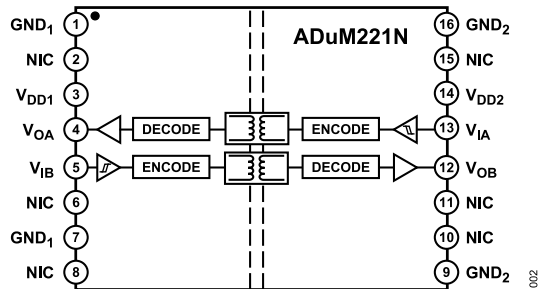

Figure 2.

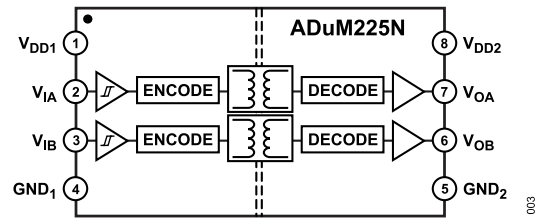

Figure 3.

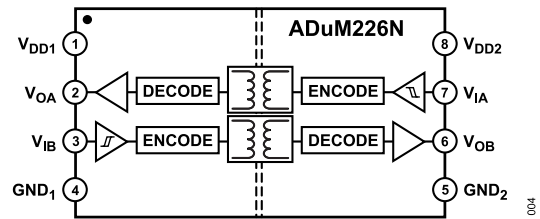

Figure 4.

SPECIFICATIONS

ELECTRICAL CHARACTERISTICS—5 V OPERATION

All typical specifications are at $T_A = 25^\circ\text{C}$, $V_{DD1} = V_{DD2} = 5\text{ V}$. Minimum/maximum specifications apply over the entire recommended operation range of $4.5\text{ V} \leq V_{DD1} \leq 5.5\text{ V}$, $4.5\text{ V} \leq V_{DD2} \leq 5.5\text{ V}$, and $-40^\circ\text{C} \leq T_A \leq +125^\circ\text{C}$, unless otherwise noted. Switching specifications are tested with $C_L = 15\text{ pF}$ and CMOS signal levels, unless otherwise noted. Supply currents are specified with 50% duty cycle signals.

Table 1.

| Parameter | Symbol | Min | Typ | Max | Unit | Test Conditions/Comments |
|---------------------------------|-----------------------|----------------------|-----------------|----------------------|----------------------|--|
| SWITCHING SPECIFICATIONS | | | | | | |
| Pulse Width | PW | 6.6 | | | ns | Within pulse width distortion (PWD) limit |
| Data Rate | | 150 | | | Mbps | Within PWD limit |
| Propagation Delay | t_{PHL} , t_{PLH} | 4.8 | 7.2 | 13 | ns | 50% input to 50% output |
| Pulse Width Distortion | PWD | | 0.5 | 3 | ns | $ t_{PLH} - t_{PHL} $ |
| Change vs. Temperature | | | 1.5 | | ps/ $^\circ\text{C}$ | |
| Propagation Delay Skew | t_{PSK} | | | 6.0 | ns | Between any two units at the same temperature, voltage, and load |
| Channel Matching | | | | | | |
| Codirectional | t_{PSKCD} | | 0.5 | 3.0 | ns | |
| Opposing Direction | t_{PSKOD} | | 0.5 | 3.0 | ns | |
| Jitter | | | 380 | | ps p-p | See the Jitter Measurement section |
| | | | 55 | | ps rms | See the Jitter Measurement section |
| DC SPECIFICATIONS | | | | | | |
| Input Threshold | | | | | | |
| Logic High | V_{IH} | $0.7 \times V_{DDx}$ | | | V | |
| Logic Low | V_{IL} | | | $0.3 \times V_{DDx}$ | V | |
| Output Voltage | | | | | | |
| Logic High | V_{OH} | $V_{DDx} - 0.1$ | V_{DDx} | | V | $I_{Ox}^1 = -20\ \mu\text{A}$, $V_{Ix} = V_{IxH}^2$ |
| | | $V_{DDx} - 0.4$ | $V_{DDx} - 0.2$ | | V | $I_{Ox}^1 = -4\ \text{mA}$, $V_{Ix} = V_{IxH}^2$ |
| Logic Low | V_{OL} | | 0.0 | 0.1 | V | $I_{Ox}^1 = 20\ \mu\text{A}$, $V_{Ix} = V_{IxL}^3$ |
| | | | 0.2 | 0.4 | V | $I_{Ox}^1 = 4\ \text{mA}$, $V_{Ix} = V_{IxL}^3$ |
| Input Current per Channel | I_I | -10 | +0.01 | +10 | μA | $0\text{ V} \leq V_{Ix} \leq V_{DDx}$ |
| Quiescent Supply Current | | | | | | |
| ADuM220N/ADuM225N | | | | | | |
| | $I_{DD1(Q)}$ | | 0.9 | 1.3 | mA | $V_I^4 = 0\ (N0)$, $1\ (N1)^5$ |
| | $I_{DD2(Q)}$ | | 1.3 | 1.8 | mA | $V_I^4 = 0\ (N0)$, $1\ (N1)^5$ |
| | $I_{DD1(Q)}$ | | 6.4 | 10.0 | mA | $V_I^4 = 1\ (N0)$, $0\ (N1)^5$ |
| | $I_{DD2(Q)}$ | | 1.4 | 1.9 | mA | $V_I^4 = 1\ (N0)$, $0\ (N1)^5$ |
| ADuM221N/ADuM226N | | | | | | |
| | $I_{DD1(Q)}$ | | 1.1 | 1.6 | mA | $V_I^4 = 0\ (N0)$, $1\ (N1)^5$ |
| | $I_{DD2(Q)}$ | | 1.1 | 1.5 | mA | $V_I^4 = 0\ (N0)$, $1\ (N1)^5$ |
| | $I_{DD1(Q)}$ | | 4.0 | 5.8 | mA | $V_I^4 = 1\ (N0)$, $0\ (N1)^5$ |
| | $I_{DD2(Q)}$ | | 4.9 | 6.4 | mA | $V_I^4 = 1\ (N0)$, $0\ (N1)^5$ |
| Dynamic Supply Current | | | | | | |
| Dynamic Input | $I_{DDI(D)}$ | | 0.01 | | mA/Mbps | Inputs switching, 50% duty cycle |
| Dynamic Output | $I_{DDO(D)}$ | | 0.02 | | mA/Mbps | Inputs switching, 50% duty cycle |
| Undervoltage Lockout | UVLO | | | | | |
| Positive V_{DDx} Threshold | V_{DDxUV+} | | 1.6 | | V | |
| Negative V_{DDx} Threshold | V_{DDxUV-} | | 1.5 | | V | |
| V_{DDx} Hysteresis | V_{DDxUVH} | | 0.1 | | V | |
| AC SPECIFICATIONS | | | | | | |
| Output Rise/Fall Time | t_R/t_F | | 2.5 | | ns | 10% to 90% |

SPECIFICATIONS

Table 1. (Continued)

| Parameter | Symbol | Min | Typ | Max | Unit | Test Conditions/Comments |
|---|-----------------|-----|-----|-----|-------|--|
| Common-Mode Transient Immunity ⁶ | CM _H | 75 | 100 | | kV/μs | V _{Ix} = V _{DDx} , V _{CM} = 1000 V, transient magnitude = 800 V |
| | CM _L | 75 | 100 | | kV/μs | V _{Ix} = 0 V, V _{CM} = 1000 V, transient magnitude = 800 V |

¹ I_{Ox} is the Channel x output current, where x is A or B.

² V_{IxH} is the input side logic high.

³ V_{IxL} is the input side logic low.

⁴ V_I is the voltage input.

⁵ N0 refers to the ADuM220N0/ADuM221N0/ADuM225N0/ADuM226N0 models, and N1 refers to the ADuM220N1/ADuM221N1/ADuM225N1/ADuM226N1 models. See the [Ordering Guide](#) section.

⁶ |CM_H| is the maximum common-mode voltage slew rate that can be sustained while maintaining the voltage output (V_O) > 0.8 V_{DDx}. |CM_L| is the maximum common-mode voltage slew rate that can be sustained while maintaining V_O > 0.8 V. The common-mode voltage slew rates apply to both rising and falling common-mode voltage edges.

Table 2. Total Supply Current vs. Data Throughput

| Parameter | Symbol | 1 Mbps | | | 25 Mbps | | | 100 Mbps | | | Unit |
|-----------------------|------------------|--------|-----|-----|---------|-----|-----|----------|-----|-----|------|
| | | Min | Typ | Max | Min | Typ | Max | Min | Typ | Max | |
| SUPPLY CURRENT | | | | | | | | | | | |
| ADuM220N/ADuM225N | | | | | | | | | | | |
| Supply Current Side 1 | I _{DD1} | | 3.7 | 6.8 | | 4.2 | 7.2 | | 6.2 | 9.3 | mA |
| Supply Current Side 2 | I _{DD2} | | 1.4 | 2.0 | | 2.2 | 3.2 | | 4.8 | 8.1 | mA |
| ADuM221N/ADuM226N | | | | | | | | | | | |
| Supply Current Side 1 | I _{DD1} | | 2.6 | 4.5 | | 3.2 | 5.4 | | 5.4 | 8.2 | mA |
| Supply Current Side 2 | I _{DD2} | | 3.0 | 4.9 | | 3.7 | 5.9 | | 5.9 | 8.6 | mA |

ELECTRICAL CHARACTERISTICS—3.3 V OPERATION

All typical specifications are at T_A = 25°C, V_{DD1} = V_{DD2} = 3.3 V. Minimum/maximum specifications apply over the entire recommended operation range: 3.0 V ≤ V_{DD1} ≤ 3.6 V, 3.0 V ≤ V_{DD2} ≤ 3.6 V, and -40°C ≤ T_A ≤ +125°C, unless otherwise noted. Switching specifications are tested with C_L = 15 pF and CMOS signal levels, unless otherwise noted. Supply currents are specified with 50% duty cycle signals.

Table 3.

| Parameter | Symbol | Min | Typ | Max | Unit | Test Conditions/Comments |
|--------------------------|-------------------------------------|------------------------|-----|------------------------|--------|--|
| SWITCHING SPECIFICATIONS | | | | | | |
| Pulse Width | PW | 6.6 | | | ns | Within PWD limit |
| Data Rate | | 150 | | | Mbps | Within PWD limit |
| Propagation Delay | t _{PHL} , t _{PLH} | 4.8 | 6.8 | 14 | ns | 50% input to 50% output |
| Pulse Width Distortion | PWD | | 0.7 | 3 | ns | t _{PLH} - t _{PHL} |
| Change vs. Temperature | | | 1.5 | | ps/°C | |
| Propagation Delay Skew | t _{PSK} | | | 7.0 | ns | Between any two units at the same temperature, voltage, and load |
| Channel Matching | | | | | | |
| Codirectional | t _{PSKCD} | | 0.7 | 3.0 | ns | |
| Opposing Direction | t _{PSKOD} | | 0.7 | 3.0 | ns | |
| Jitter | | | 290 | | ps p-p | See the Jitter Measurement section |
| | | | 45 | | ps rms | See the Jitter Measurement section |
| DC SPECIFICATIONS | | | | | | |
| Input Threshold | | | | | | |
| Logic High | V _{IH} | 0.7 × V _{DDx} | | | V | |
| Logic Low | V _{IL} | | | 0.3 × V _{DDx} | V | |

SPECIFICATIONS

Table 3. (Continued)

| Parameter | Symbol | Min | Typ | Max | Unit | Test Conditions/Comments |
|---|--------------|-----------------|-----------------|-----|-------------|---|
| Output Voltage | | | | | | |
| Logic High | V_{OH} | $V_{DDx} - 0.1$ | V_{DDx} | | V | $I_{Ox}^1 = -20 \mu A, V_{Ix} = V_{IxH}^2$ |
| | | $V_{DDx} - 0.4$ | $V_{DDx} - 0.2$ | | V | $I_{Ox}^1 = -2 \text{ mA}, V_{Ix} = V_{IxH}^2$ |
| Logic Low | V_{OL} | | 0.0 | 0.1 | V | $I_{Ox}^1 = 20 \mu A, V_{Ix} = V_{IxL}^3$ |
| | | | 0.2 | 0.4 | V | $I_{Ox}^1 = 2 \text{ mA}, V_{Ix} = V_{IxL}^3$ |
| Input Current per Channel | I_I | -10 | +0.01 | +10 | μA | $0 \text{ V} \leq V_{Ix} \leq V_{DDx}$ |
| Quiescent Supply Current | | | | | | |
| ADuM220N/ADuM225N | $I_{DD1(Q)}$ | | 0.8 | 1.3 | mA | $V_I^4 = 0 \text{ (N0)}, 1 \text{ (N1)}^5$ |
| | $I_{DD2(Q)}$ | | 1.2 | 1.8 | mA | $V_I^4 = 0 \text{ (N0)}, 1 \text{ (N1)}^5$ |
| | $I_{DD1(Q)}$ | | 6.3 | 9.7 | mA | $V_I^4 = 1 \text{ (N0)}, 0 \text{ (N1)}^5$ |
| | $I_{DD2(Q)}$ | | 1.3 | 1.8 | mA | $V_I^4 = 1 \text{ (N0)}, 0 \text{ (N1)}^5$ |
| ADuM221N/ADuM226N | $I_{DD1(Q)}$ | | 1.0 | 1.6 | mA | $V_I^4 = 0 \text{ (N0)}, 1 \text{ (N1)}^5$ |
| | $I_{DD2(Q)}$ | | 1.0 | 1.5 | mA | $V_I^4 = 0 \text{ (N0)}, 1 \text{ (N1)}^5$ |
| | $I_{DD1(Q)}$ | | 3.9 | 5.8 | mA | $V_I^4 = 1 \text{ (N0)}, 0 \text{ (N1)}^5$ |
| | $I_{DD2(Q)}$ | | 4.8 | 6.4 | mA | $V_I^4 = 1 \text{ (N0)}, 0 \text{ (N1)}^5$ |
| Dynamic Supply Current | | | | | | Inputs switching, 50% duty cycle |
| Dynamic Input | $I_{DDI(D)}$ | | 0.01 | | mA/Mbps | |
| Dynamic Output | $I_{DDO(D)}$ | | 0.01 | | mA/Mbps | |
| Undervoltage Lockout | UVLO | | | | | |
| Positive V_{DDx} Threshold | V_{DDxUV+} | | 1.6 | | V | |
| Negative V_{DDx} Threshold | V_{DDxUV-} | | 1.5 | | V | |
| V_{DDx} Hysteresis | V_{DDxUVH} | | 0.1 | | V | |
| AC SPECIFICATIONS | | | | | | |
| Output Rise/Fall Time | t_R/t_F | | 2.5 | | ns | 10% to 90% |
| Common-Mode Transient Immunity ⁶ | $ CM_H $ | 75 | 100 | | kV/ μs | $V_{Ix} = V_{DDx}, V_{CM} = 1000 \text{ V}$, transient magnitude = 800 V |
| | $ CM_L $ | 75 | 100 | | kV/ μs | $V_{Ix} = 0 \text{ V}, V_{CM} = 1000 \text{ V}$, transient magnitude = 800 V |

¹ I_{Ox} is the Channel x output current, where x is A or B.

² V_{IxH} is the input side logic high.

³ V_{IxL} is the input side logic low.

⁴ V_I is the voltage input.

⁵ N0 refers to the ADuM220N0/ADuM221N0/ADuM225N0/ADuM226N0 models, and N1 refers to the ADuM220N1/ADuM221N1/ADuM225N1/ADuM226N1 models. See the [Ordering Guide](#) section.

⁶ $|CM_H|$ is the maximum common-mode voltage slew rate that can be sustained while maintaining $V_O > 0.8 V_{DDx}$. $|CM_L|$ is the maximum common-mode voltage slew rate that can be sustained while maintaining $V_O > 0.8 \text{ V}$. The common-mode voltage slew rates apply to both rising and falling common-mode voltage edges.

Table 4. Total Supply Current vs. Data Throughput

| Parameter | Symbol | 1 Mbps | | | 25 Mbps | | | 100 Mbps | | | Unit |
|-----------------------|-----------|--------|-----|-----|---------|-----|-----|----------|-----|-----|------|
| | | Min | Typ | Max | Min | Typ | Max | Min | Typ | Max | |
| SUPPLY CURRENT | | | | | | | | | | | |
| ADuM220N/ADuM225N | | | | | | | | | | | |
| Supply Current Side 1 | I_{DD1} | | 3.6 | 6.2 | | 4.0 | 6.7 | | 5.6 | 9.1 | mA |
| Supply Current Side 2 | I_{DD2} | | 1.3 | 1.9 | | 2.1 | 3.1 | | 4.4 | 6.8 | mA |

SPECIFICATIONS

Table 4. Total Supply Current vs. Data Throughput (Continued)

| Parameter | Symbol | 1 Mbps | | | 25 Mbps | | | 100 Mbps | | | Unit |
|-----------------------|-----------|--------|-----|-----|---------|-----|-----|----------|-----|-----|------|
| | | Min | Typ | Max | Min | Typ | Max | Min | Typ | Max | |
| ADuM221N/ADuM226N | | | | | | | | | | | |
| Supply Current Side 1 | I_{DD1} | | 2.5 | 4.6 | | 3.0 | 5.5 | | 5.0 | 8.1 | mA |
| Supply Current Side 2 | I_{DD2} | | 2.9 | 4.8 | | 3.5 | 5.8 | | 5.4 | 8.3 | mA |

ELECTRICAL CHARACTERISTICS—2.5 V OPERATION

All typical specifications are at $T_A = 25^\circ\text{C}$, $V_{DD1} = V_{DD2} = 2.5\text{ V}$. Minimum/maximum specifications apply over the entire recommended operation range: $2.25\text{ V} \leq V_{DD1} \leq 2.75\text{ V}$, $2.25\text{ V} \leq V_{DD2} \leq 2.75\text{ V}$, $-40^\circ\text{C} \leq T_A \leq +125^\circ\text{C}$, unless otherwise noted. Switching specifications are tested with $C_L = 15\text{ pF}$ and CMOS signal levels, unless otherwise noted. Supply currents are specified with 50% duty cycle signals.

Table 5.

| Parameter | Symbol | Min | Typ | Max | Unit | Test Conditions/Comments |
|---------------------------|-----------------------|----------------------|-----------------|----------------------|----------------------|--|
| SWITCHING SPECIFICATIONS | | | | | | |
| Pulse Width | PW | 6.6 | | | ns | Within PWD limit |
| Data Rate | | 150 | | | Mbps | Within PWD limit |
| Propagation Delay | t_{PHL} , t_{PLH} | 5.0 | 7.0 | 14 | ns | 50% input to 50% output |
| Pulse Width Distortion | PWD | | 0.7 | 3 | ns | $ t_{PLH} - t_{PHL} $ |
| Change vs. Temperature | | | 1.5 | | ps/ $^\circ\text{C}$ | |
| Propagation Delay Skew | t_{PSK} | | | 7.0 | ns | Between any two units at the same temperature, voltage, and load |
| Channel Matching | | | | | | |
| Codirectional | t_{PSKCD} | | 0.7 | 3.0 | ns | |
| Opposing Direction | t_{PSKOD} | | 0.7 | 3.0 | ns | |
| Jitter | | | 320 | | ps p-p | See the Jitter Measurement section |
| | | | 65 | | ps rms | See the Jitter Measurement section |
| DC SPECIFICATIONS | | | | | | |
| Input Threshold | | | | | | |
| Logic High | V_{IH} | $0.7 \times V_{DDx}$ | | | V | |
| Logic Low | V_{IL} | | | $0.3 \times V_{DDx}$ | V | |
| Output Voltage | | | | | | |
| Logic High | V_{OH} | $V_{DDx} - 0.1$ | V_{DDx} | | V | $I_{Ox}^1 = -20\ \mu\text{A}$, $V_{Ix} = V_{IxH}^2$ |
| | | $V_{DDx} - 0.4$ | $V_{DDx} - 0.2$ | | V | $I_{Ox}^1 = -2\ \text{mA}$, $V_{Ix} = V_{IxH}^2$ |
| Logic Low | V_{OL} | | 0.0 | 0.1 | V | $I_{Ox}^1 = 20\ \mu\text{A}$, $V_{Ix} = V_{IxL}^3$ |
| | | | 0.2 | 0.4 | V | $I_{Ox}^1 = 2\ \text{mA}$, $V_{Ix} = V_{IxL}^3$ |
| Input Current per Channel | I_I | -10 | +0.01 | +10 | μA | $0\text{ V} \leq V_{Ix} \leq V_{DDx}$ |
| Quiescent Supply Current | | | | | | |
| ADuM220N/ADuM225N | | | | | | |
| | $I_{DD1(Q)}$ | | 0.8 | 1.2 | mA | $V_I^4 = 0\ (N0)$, $1\ (N1)^5$ |
| | $I_{DD2(Q)}$ | | 1.2 | 1.8 | mA | $V_I^4 = 0\ (N0)$, $1\ (N1)^5$ |
| | $I_{DD1(Q)}$ | | 6.2 | 9.5 | mA | $V_I^4 = 1\ (N0)$, $0\ (N1)^5$ |
| | $I_{DD2(Q)}$ | | 1.3 | 1.8 | mA | $V_I^4 = 1\ (N0)$, $0\ (N1)^5$ |
| ADuM221N/ADuM226N | | | | | | |
| | $I_{DD1(Q)}$ | | 1.0 | 1.5 | mA | $V_I^4 = 0\ (N0)$, $1\ (N1)^5$ |
| | $I_{DD2(Q)}$ | | 1.0 | 1.4 | mA | $V_I^4 = 0\ (N0)$, $1\ (N1)^5$ |
| | $I_{DD1(Q)}$ | | 3.9 | 5.8 | mA | $V_I^4 = 1\ (N0)$, $0\ (N1)^5$ |
| | $I_{DD2(Q)}$ | | 4.8 | 6.4 | mA | $V_I^4 = 1\ (N0)$, $0\ (N1)^5$ |
| Dynamic Supply Current | | | | | | |
| Dynamic Input | $I_{DDI(D)}$ | | 0.01 | | mA/Mbps | Inputs switching, 50% duty cycle |

SPECIFICATIONS

Table 5. (Continued)

| Parameter | Symbol | Min | Typ | Max | Unit | Test Conditions/Comments |
|---|--------------|-----|------|-----|-------------|---|
| Dynamic Output Undervoltage Lockout | $I_{DDO(D)}$ | | 0.01 | | mA/Mbps | |
| Positive V_{DDx} Threshold | V_{DDxUV+} | | 1.6 | | V | |
| Negative V_{DDx} Threshold | V_{DDxUV-} | | 1.5 | | V | |
| V_{DDx} Hysteresis | V_{DDxUVH} | | 0.1 | | V | |
| AC SPECIFICATIONS | | | | | | |
| Output Rise/Fall Time | t_R/t_F | | 2.5 | | ns | 10% to 90% |
| Common-Mode Transient Immunity ⁶ | $ CM_H $ | 75 | 100 | | kV/ μ s | $V_{IX} = V_{DDx}$, $V_{CM} = 1000$ V, transient magnitude = 800 V |
| | $ CM_L $ | 75 | 100 | | kV/ μ s | $V_{IX} = 0$ V, $V_{CM} = 1000$ V, transient magnitude = 800 V |

¹ I_{Ox} is the Channel x output current, where x is A or B.

² V_{IXH} is the input side logic high.

³ V_{IXL} is the input side logic low.

⁴ V_I is the voltage input.

⁵ N0 refers to the ADuM220N0/ADuM221N0/ADuM225N0/ADuM226N0 models, and N1 refers to the ADuM220N1/ADuM221N1/ADuM225N1/ADuM226N1 models. See the [Ordering Guide](#) section.

⁶ $|CM_H|$ is the maximum common-mode voltage slew rate that can be sustained while maintaining $V_O > 0.8 V_{DDx}$. $|CM_L|$ is the maximum common-mode voltage slew rate that can be sustained while maintaining $V_O > 0.8$ V. The common-mode voltage slew rates apply to both rising and falling common-mode voltage edges.

Table 6. Total Supply Current vs. Data Throughput

| Parameter | Symbol | 1 Mbps | | | 25 Mbps | | | 100 Mbps | | | Unit |
|-----------------------|-----------|--------|-----|-----|---------|-----|-----|----------|-----|-----|------|
| | | Min | Typ | Max | Min | Typ | Max | Min | Typ | Max | |
| SUPPLY CURRENT | | | | | | | | | | | |
| ADuM220N/ADuM225N | | | | | | | | | | | |
| Supply Current Side 1 | I_{DD1} | | 3.5 | 6.2 | | 3.9 | 6.6 | | 5.4 | 9.0 | mA |
| Supply Current Side 2 | I_{DD2} | | 1.3 | 1.9 | | 1.9 | 2.8 | | 3.6 | 5.8 | mA |
| ADuM221N/ADuM226N | | | | | | | | | | | |
| Supply Current Side 1 | I_{DD1} | | 2.4 | 4.7 | | 2.9 | 5.5 | | 4.5 | 8.0 | mA |
| Supply Current Side 2 | I_{DD2} | | 2.9 | 4.9 | | 3.3 | 5.7 | | 4.9 | 7.7 | mA |

ELECTRICAL CHARACTERISTICS—1.8 V OPERATION

All typical specifications are at $T_A = 25^\circ\text{C}$, $V_{DD1} = V_{DD2} = 1.8$ V. Minimum/maximum specifications apply over the entire recommended operation range: $1.7\text{ V} \leq V_{DD1} \leq 1.9\text{ V}$, $1.7\text{ V} \leq V_{DD2} \leq 1.9\text{ V}$, and $-40^\circ\text{C} \leq T_A \leq +125^\circ\text{C}$, unless otherwise noted. Switching specifications are tested with $C_L = 15$ pF and CMOS signal levels, unless otherwise noted. Supply currents are specified with 50% duty cycle signals.

Table 7.

| Parameter | Symbol | Min | Typ | Max | Unit | Test Conditions/Comments |
|--------------------------|-----------------------|-----|-----|-----|----------------------|--|
| SWITCHING SPECIFICATIONS | | | | | | |
| Pulse Width | PW | 6.6 | | | ns | Within PWD limit |
| Data Rate | | 150 | | | Mbps | Within PWD limit |
| Propagation Delay | t_{PHL} , t_{PLH} | 5.8 | 8.7 | 15 | ns | 50% input to 50% output |
| Pulse Width Distortion | PWD | | 0.7 | 3 | ns | $ t_{PLH} - t_{PHL} $ |
| Change vs. Temperature | | | 1.5 | | ps/ $^\circ\text{C}$ | |
| Propagation Delay Skew | t_{PSK} | | | 7.0 | ns | Between any two units at the same temperature, voltage, and load |
| Channel Matching | | | | | | |
| Codirectional | t_{PSKCD} | | 0.7 | 3.0 | ns | |

SPECIFICATIONS

Table 7. (Continued)

| Parameter | Symbol | Min | Typ | Max | Unit | Test Conditions/Comments |
|---|---------------|----------------------|-----------------|----------------------|-------------|---|
| Opposing Direction Jitter | t_{PSKOD} | | 0.7 | 3.0 | ns | |
| | | | 630 | | ps p-p | See the Jitter Measurement section |
| | | | 190 | | ps rms | See the Jitter Measurement section |
| DC SPECIFICATIONS | | | | | | |
| Input Threshold | | | | | | |
| Logic High | V_{IH} | $0.7 \times V_{DDx}$ | | | V | |
| Logic Low | V_{IL} | | | $0.3 \times V_{DDx}$ | V | |
| Output Voltage | | | | | | |
| Logic High | V_{OH} | $V_{DDx} - 0.1$ | V_{DDx} | | V | $I_{Ox}^1 = -20 \mu A, V_{Ix} = V_{IxH}^2$ |
| | | $V_{DDx} - 0.4$ | $V_{DDx} - 0.2$ | | V | $I_{Ox}^1 = -2 \text{ mA}, V_{Ix} = V_{IxH}^2$ |
| Logic Low | V_{OL} | | 0.0 | 0.1 | V | $I_{Ox}^1 = 20 \mu A, V_{Ix} = V_{IxL}^3$ |
| | | | 0.2 | 0.4 | V | $I_{Ox}^1 = 2 \text{ mA}, V_{Ix} = V_{IxL}^3$ |
| Input Current per Channel | I_i | -10 | +0.01 | +10 | μA | $0 V \leq V_{Ix} \leq V_{DDx}$ |
| Quiescent Supply Current | | | | | | |
| ADuM220N/ADuM225N | | | | | | |
| | $I_{DD1 (Q)}$ | | 0.7 | 1.2 | mA | $V_i^4 = 0 (N0), 1 (N1)^5$ |
| | $I_{DD2 (Q)}$ | | 1.2 | 1.8 | mA | $V_i^3 = 0 (N0), 1 (N1)^5$ |
| | $I_{DD1 (Q)}$ | | 6.2 | 9.6 | mA | $V_i^3 = 1 (N0), 0 (N1)^5$ |
| | $I_{DD2 (Q)}$ | | 1.3 | 1.8 | mA | $V_i^4 = 1 (N0), 0 (N1)^5$ |
| ADuM221N/ADuM226N | | | | | | |
| | $I_{DD1 (Q)}$ | | 1.0 | 1.5 | mA | $V_i^4 = 0 (N0), 1 (N1)^5$ |
| | $I_{DD2 (Q)}$ | | 1.0 | 1.4 | mA | $V_i^4 = 0 (N0), 1 (N1)^5$ |
| | $I_{DD1 (Q)}$ | | 3.8 | 5.8 | mA | $V_i^4 = 1 (N0), 0 (N1)^5$ |
| | $I_{DD2 (Q)}$ | | 4.7 | 6.4 | mA | $V_i^4 = 1 (N0), 0 (N1)^5$ |
| Dynamic Supply Current | | | | | | Inputs switching, 50% duty cycle |
| Dynamic Input | $I_{DDI (D)}$ | | 0.01 | | mA/Mbps | |
| Dynamic Output | $I_{DDO (D)}$ | | 0.01 | | mA/Mbps | |
| Undervoltage Lockout | UVLO | | | | | |
| Positive V_{DDx} Threshold | V_{DDxUV+} | | 1.6 | | V | |
| Negative V_{DDx} Threshold | V_{DDxUV-} | | 1.5 | | V | |
| V_{DDx} Hysteresis | V_{DDxUVH} | | 0.1 | | V | |
| AC SPECIFICATIONS | | | | | | |
| Output Rise/Fall Time | t_R/t_F | | 2.5 | | ns | 10% to 90% |
| Common-Mode Transient Immunity ⁶ | $ CM_H $ | 75 | 100 | | kV/ μs | $V_{Ix} = V_{DDx}, V_{CM} = 1000 \text{ V}$, transient magnitude = 800 V |
| | $ CM_L $ | 75 | 100 | | kV/ μs | $V_{Ix} = 0 \text{ V}, V_{CM} = 1000 \text{ V}$, transient magnitude = 800 V |

¹ I_{Ox} is the Channel x output current, where x is A or B.

² V_{IxH} is the input side logic high.

³ V_{IxL} is the input side logic low.

⁴ V_i is the voltage input.

⁵ N0 refers to the ADuM220N0/ADuM221N0/ADuM225N0/ADuM226N0 models, and N1 refers to the ADuM220N1/ADuM221N1/ADuM225N1/ADuM226N1 models. See the [Ordering Guide](#) section.

⁶ $|CM_H|$ is the maximum common-mode voltage slew rate that can be sustained while maintaining $V_O > 0.8 V_{DDx}$. $|CM_L|$ is the maximum common-mode voltage slew rate that can be sustained while maintaining $V_O > 0.8 \text{ V}$. The common-mode voltage slew rates apply to both rising and falling common-mode voltage edges.

SPECIFICATIONS

Table 8. Total Supply Current vs. Data Throughput

| Parameter | Symbol | 1 Mbps | | | 25 Mbps | | | 100 Mbps | | | Unit |
|-----------------------|-----------|--------|-----|-----|---------|-----|-----|----------|-----|-----|------|
| | | Min | Typ | Max | Min | Typ | Max | Min | Typ | Max | |
| SUPPLY CURRENT | | | | | | | | | | | |
| ADuM220N/ADuM225N | | | | | | | | | | | |
| Supply Current Side 1 | I_{DD1} | | 3.4 | 6.0 | | 3.8 | 6.4 | | 5.2 | 8.4 | mA |
| Supply Current Side 2 | I_{DD2} | | 1.2 | 1.8 | | 1.8 | 2.8 | | 3.6 | 5.8 | mA |
| ADuM221N/ADuM226N | | | | | | | | | | | |
| Supply Current Side 1 | I_{DD1} | | 2.4 | 4.7 | | 2.8 | 5.5 | | 4.4 | 7.8 | mA |
| Supply Current Side 2 | I_{DD2} | | 2.8 | 4.8 | | 3.2 | 5.6 | | 4.8 | 7.9 | mA |

INSULATION AND SAFETY RELATED SPECIFICATIONS

For additional information, see www.analog.com/icouplersafety.

Table 9. ADuM220N/ADuM221N

| Parameter | Symbol | Value | Unit | Test Conditions/Comments |
|---|---------|-------|-------------------|--|
| Rated Dielectric Insulation Voltage | | 5000 | V rms | 1-minute duration |
| Minimum External Air Gap (Clearance) | L (I01) | 7.8 | mm min | Measured from input terminals to output terminals, shortest distance through air |
| Minimum External Tracking (Creepage) | L (I02) | 7.8 | mm min | Measured from input terminals to output terminals, shortest distance path along body |
| Minimum Clearance in the Plane of the Printed Circuit Board (PCB Clearance) | L (PCB) | 8.3 | mm min | Measured from input terminals to output terminals, shortest distance through air, line of sight, in the PCB mounting plane |
| Minimum Internal Gap (Internal Clearance) | | 25.5 | μm min | Insulation distance through insulation |
| Tracking Resistance (Comparative Tracking Index) | CTI | >400 | V | DIN IEC 112/VDE 0303 Part 1 |
| Material Group | | II | | Material Group (DIN VDE 0110, 1/89, Table 1) |

Table 10. ADuM225N/ADuM226N

| Parameter | Symbol | Value | Unit | Test Conditions/Comments |
|---|---------|-------|-------------------|--|
| Rated Dielectric Insulation Voltage | | 5000 | V rms | 1-minute duration |
| Minimum External Air Gap (Clearance) | L (I01) | 8.3 | mm min | Measured from input terminals to output terminals, shortest distance through air |
| Minimum External Tracking (Creepage) | L (I02) | 8.3 | mm min | Measured from input terminals to output terminals, shortest distance path along body |
| Minimum Clearance in the Plane of the Printed Circuit Board (PCB Clearance) | L (PCB) | 8.3 | mm min | Measured from input terminals to output terminals, shortest distance through air, line of sight, in the PCB mounting plane |
| Minimum Internal Gap (Internal Clearance) | | 25.5 | μm min | Insulation distance through insulation |
| Tracking Resistance (Comparative Tracking Index) | CTI | >400 | V | DIN IEC 112/VDE 0303 Part 1 |
| Material Group | | II | | Material Group (DIN VDE 0110, 1/89, Table 1) |

SPECIFICATIONS

PACKAGE CHARACTERISTICS

Table 11. ADuM220N/ADuM221N

| Parameter | Symbol | Min | Typ | Max | Unit | Test Conditions/Comments |
|--|------------------|-----|------------------|-----|------|---|
| Resistance (Input to Output) ¹ | R _{I-O} | | 10 ¹³ | | Ω | |
| Capacitance (Input to Output) ¹ | C _{I-O} | | 2.2 | | pF | f = 1 MHz |
| Input Capacitance ² | C _I | | 4.0 | | pF | |
| IC Junction to Ambient Thermal Resistance | θ _{JA} | | 45 | | °C/W | Thermocouple located at center of package underside |

¹ These devices are considered 2-terminal devices: Pin 1 through Pin 8 are shorted together, and Pin 9 through Pin 16 are shorted together.

² Input capacitance is from any input data pin to ground.

Table 12. ADuM225N/ADuM226N

| Parameter | Symbol | Min | Typ | Max | Unit | Test Conditions/Comments |
|--|------------------|-----|------------------|-----|------|---|
| Resistance (Input to Output) ¹ | R _{I-O} | | 10 ¹³ | | Ω | |
| Capacitance (Input to Output) ¹ | C _{I-O} | | 2.2 | | pF | f = 1 MHz |
| Input Capacitance ² | C _I | | 4.0 | | pF | |
| IC Junction to Ambient Thermal Resistance | θ _{JA} | | 80 | | °C/W | Thermocouple located at center of package underside |

¹ These devices are considered 2-terminal devices: Pin 1 through Pin 4 are shorted together, and Pin 5 through Pin 8 are shorted together.

² Input capacitance is from any input data pin to ground.

REGULATORY INFORMATION

See Table 18 and Table 19 and the [Insulation Lifetime](#) section for details regarding recommended maximum working voltages for specific cross isolation waveforms and insulation levels.

The ADuM220N/ADuM221N are approved or pending approval by the organizations listed in Table 13.

Table 13.

| UL | CSA | VDE | CQC |
|---|--|--|--|
| Recognized Under UL 1577 Component Recognition Program ¹ | Approved under CSA Component Acceptance | DIN V VDE V 0884-10 (VDE V 0884-10):2006-12 ² | Certified by CQC11-471543-2015 |
| Single Protection, 5000 V rms Isolation Voltage | CSA 62368-1:19, IEC 62368-1:2018 Ed. 3, EN 62368-1:2020+A11:2020 Basic insulation at 780 V rms (1103 V peak) Reinforced insulation at 390 V rms (552 V peak) | Reinforced insulation, 849 V peak, V _{IOSM} = 10,000 V peak Basic insulation 849 V peak, V _{IOSM} = 16,000 V peak | GB4943.1-2011 Basic insulation at 780 V rms (1103 V peak) |
| Double Protection, 5000 V rms Isolation Voltage | CSA 60601-1:14 (R2018) and IEC60601-1 Ed. 3+A1+A2 Basic insulation (1 means of patient protection (MOPP)), 490 V rms (693 V peak) Reinforced insulation (2 MOPP), 50 V rms (71 V peak) CSA 61010-1-12 and IEC 61010-1 third edition Basic insulation at 300 V rms mains, 780 V secondary Reinforced insulation at: 300 V rms mains, 390 V secondary | | Reinforced insulation at 389 V rms (552 V peak) |
| File E214100 | File 205078 | File 2471900-4880-0001 | File (CQC16001160971) |

¹ In accordance with UL 1577, each ADuM220N/ADuM221N is proof tested by applying an insulation test voltage ≥ 6000 V rms for 1 sec.

² In accordance with DIN V VDE V 0884-10, each ADuM220N/ADuM221N is proof tested by applying an insulation test voltage ≥ 1592 V peak for 1 sec (partial discharge detection limit = 5 pC). The * marking branded on the component designates DIN V VDE V 0884-10 approval.

SPECIFICATIONS

The ADuM225N/ADuM226N are approved or pending approval by the organizations listed in [Table 14](#).

Table 14.

| UL | CSA | VDE | CQC |
|--|--|---|--|
| UL 1577 Component Recognition Program ¹ | Approved under CSA Component Acceptance | DIN V VDE V 0884-10 (VDE V 0884-10):2006-12 ² | Certified by CQC11-471543-2012 |
| Single Protection, 5000 V rms Isolation Voltage | CSA 62368-1:19, IEC 62368-1:2018 Ed. 3, EN 62368-1:2020+A11:2020 Basic insulation at 800 V rms (1131 V peak) Reinforced insulation at 400 V rms (565 V peak) | Reinforced insulation, 849 V peak, $V_{IOSM} = 10,000$ V peak | GB4943.1-2011 |
| Double Protection, 5000 V rms Isolation Voltage | CSA 60601-1:14 (R2018) and IEC60601-1 Ed. 3+A1+A2 Basic insulation (1 MOPP), 519 V rms (734 V peak) Reinforced insulation (2 MOPP), 50 V rms (71 V peak) CSA 61010-1-12 and IEC 61010-1 third edition Basic insulation at 300 V rms mains, 800 V secondary Reinforced insulation at: 300 V rms mains, 400 V secondary | Basic insulation 849 V peak, $V_{IOSM} = 16,000$ V peak | Basic insulation at 800 V rms (1131 V peak) Reinforced insulation at 400 V rms (565 V peak) |
| File E214100 | File 205078 | File 2471900-4880-0001 | File (pending) |

¹ In accordance with UL 1577, each ADuM225N/ADuM226N is proof tested by applying an insulation test voltage ≥ 6000 V rms for 1 sec.

² In accordance with DIN V VDE V 0884-10, each ADuM225N/ADuM226N is proof tested by applying an insulation test voltage ≥ 1592 V peak for 1 sec (partial discharge detection limit = 5 pC). The * marking branded on the component designates DIN V VDE V 0884-10 approval.

DIN V VDE V 0884-10 (VDE V 0884-10) INSULATION CHARACTERISTICS

These ADuM220N/ADuM221N/ADuM225N/ADuM226N isolators are suitable for reinforced electrical isolation only within the safety limit data. Protective circuits ensure the maintenance of the safety data. The * marking on packages denotes DIN V VDE V 0884-10 approval.

Table 15.

| Description | Test Conditions/Comments | Symbol | Characteristic | Unit |
|--|---|-------------|----------------|--------------|
| Installation Classification per DIN VDE 0110 | | | I to IV | |
| For Rated Mains Voltage ≤ 150 V rms | | | I to IV | |
| For Rated Mains Voltage ≤ 300 V rms | | | I to IV | |
| Climatic Classification | | | 40/105/21 | |
| Pollution Degree per DIN VDE 0110, Table 1 | | | 2 | |
| Maximum Working Insulation Voltage | | V_{IORM} | 849 | V peak |
| Input to Output Test Voltage, Method B1 | $V_{IORM} \times 1.875 = V_{pd(m)}$, 100% production test, $t_{ini} = t_m = 1$ sec, partial discharge < 5 pC | $V_{pd(m)}$ | 1592 | V peak |
| Input to Output Test Voltage, Method A | | | | |
| After Environmental Tests Subgroup 1 | $V_{IORM} \times 1.5 = V_{pd(m)}$, $t_{ini} = 60$ sec, $t_m = 10$ sec, partial discharge < 5 pC | $V_{pd(m)}$ | 1274 | V peak |
| After Input and/or Safety Test Subgroup 2 and Subgroup 3 | $V_{IORM} \times 1.2 = V_{pd(m)}$, $t_{ini} = 60$ sec, $t_m = 10$ sec, partial discharge < 5 pC | | 1019 | V peak |
| Highest Allowable Overvoltage | | V_{IOTM} | 7000 | V peak |
| Surge Isolation Voltage Basic | $V_{PEAK} = 16$ kV, 1.2 μ s rise time, 50 μ s, 50% fall time | V_{IOSM} | 16,000 | V peak |
| Surge Isolation Voltage Reinforced | $V_{PEAK} = 16$ kV, 1.2 μ s rise time, 50 μ s, 50% fall time | V_{IOSM} | 10,000 | V peak |
| Safety Limiting Values | Maximum value allowed in the event of a failure (see Figure 5 or Figure 6) | | | |
| Maximum Junction Temperature | | T_S | 150 | $^{\circ}$ C |
| Total Power Dissipation at 25 $^{\circ}$ C | | P_S | | |
| ADuM220N/ADuM221N | | | 2.78 | W |

SPECIFICATIONS

Table 15. (Continued)

| Description | Test Conditions/Comments | Symbol | Characteristic | Unit |
|---|--------------------------|----------------|------------------|------|
| ADuM225N/ADuM226N | | | 1.56 | W |
| Insulation Resistance at T _S | V _{IO} = 500 V | R _S | >10 ⁹ | Ω |

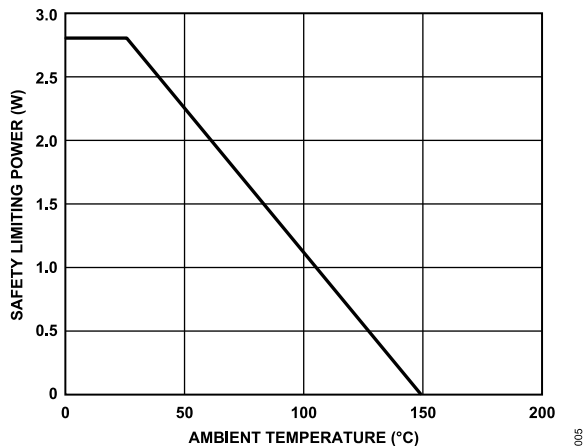

Figure 5. ADuM220N/ADuM221N Thermal Derating Curve, Dependence of Safety Limiting Values with Ambient Temperature per DIN V VDE V 0884-10

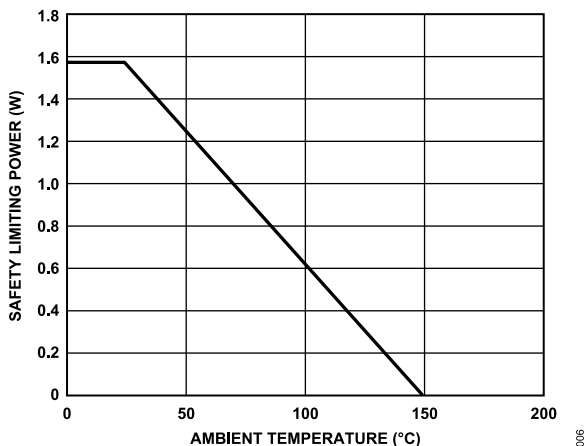

Figure 6. ADuM225N/ADuM226N Thermal Derating Curve, Dependence of Safety Limiting Values with Ambient Temperature per DIN V VDE V 0884-10

RECOMMENDED OPERATING CONDITIONS

Table 16.

| Parameter | Symbol | Rating |
|----------------------------------|-------------------------------------|-----------------|
| Operating Temperature | T _A | -40°C to +125°C |
| Supply Voltages | V _{DD1} , V _{DD2} | 1.7 V to 5.5 V |
| Input Signal Rise and Fall Times | | 1.0 ms |

ABSOLUTE MAXIMUM RATINGS

$T_A = 25^\circ\text{C}$, unless otherwise noted.

Table 17.

| Parameter | Rating |
|---|--|
| Storage Temperature (T_{ST}) Range | -65°C to $+150^\circ\text{C}$ |
| Ambient Operating Temperature (T_A) Range | -40°C to $+125^\circ\text{C}$ |
| Supply Voltages (V_{DD1} , V_{DD2}) | -0.5 V to $+7.0\text{ V}$ |
| Input Voltages (V_{IA} , V_{IB}) | -0.5 V to $V_{DD1}^1 + 0.5\text{ V}$ |
| Output Voltages (V_{OA} , V_{OB}) | -0.5 V to $V_{DDO}^2 + 0.5\text{ V}$ |
| Average Output Current per Pin ³ | |
| Side 1 Output Current (I_{O1}) | -10 mA to $+10\text{ mA}$ |
| Side 2 Output Current (I_{O2}) | -10 mA to $+10\text{ mA}$ |
| Common-Mode Transients ⁴ | $-150\text{ kV}/\mu\text{s}$ to $+150\text{ kV}/\mu\text{s}$ |

¹ V_{DD1} is the input side supply voltage.

² V_{DDO} is the output side supply voltage.

³ See Figure 5 or Figure 6 for the maximum rated current values for various temperatures.

⁴ This term refers to the common-mode transients across the insulation barrier. Common-mode transients exceeding the absolute maximum ratings may cause latch-up or permanent damage.

Stresses at or above those listed under Absolute Maximum Ratings may cause permanent damage to the product. This is a stress rating only; functional operation of the product at these or any other conditions above those indicated in the operational section of this specification is not implied. Operation beyond the maximum operating conditions for extended periods may affect product reliability.

ESD CAUTION



ESD (electrostatic discharge) sensitive device. Charged devices and circuit boards can discharge without detection. Although this product features patented or proprietary protection circuitry, damage may occur on devices subjected to high energy ESD. Therefore, proper ESD precautions should be taken to avoid performance degradation or loss of functionality.

MAXIMUM CONTINUOUS WORKING VOLTAGE

Table 18. ADuM220N/ADuM221N Maximum Continuous Working Voltage¹

| Parameter | Rating | Constraint |
|-----------------------|-------------|--|
| AC Voltage | | |
| Bipolar Waveform | | |
| Basic Insulation | 849 V peak | 50-year minimum insulation lifetime |
| Reinforced Insulation | 767 V peak | Lifetime limited by package creepage maximum approved working voltage per IEC 60950-1 ² |
| Unipolar Waveform | | |
| Basic Insulation | 1698 V peak | 50-year minimum insulation lifetime |
| Reinforced Insulation | 885 V peak | Lifetime limited by package creepage maximum approved working voltage per IEC 60950-1 ² |
| DC Voltage | | Lifetime limited by package creepage maximum approved working voltage per IEC 60950-1 ² |
| Basic Insulation | 1092 V peak | |
| Reinforced Insulation | 543 V peak | |

¹ Maximum continuous working voltage refers to the continuous voltage magnitude imposed across the isolation barrier. See the [Insulation Lifetime](#) section for more details.

² Insulation lifetime for the specified test condition is greater than 50 years.

Table 19. ADuM225N/ADuM226N Maximum Continuous Working Voltage¹

| Parameter | Rating | Constraint |
|-----------------------|-------------|--|
| AC Voltage | | |
| Bipolar Waveform | | |
| Basic Insulation | 849 V peak | 50-year minimum insulation lifetime |
| Reinforced Insulation | 789 V peak | Lifetime limited by package creepage maximum approved working voltage per IEC 60950-1 ² |
| Unipolar Waveform | | 50-year minimum insulation lifetime |
| Basic Insulation | 1698 V peak | |
| Reinforced Insulation | 849 V peak | |
| DC Voltage | | Lifetime limited by package creepage maximum approved working voltage per IEC 60950-1 ² |
| Basic Insulation | 1118 V peak | |
| Reinforced Insulation | 558 V peak | |

¹ Maximum continuous working voltage refers to the continuous voltage magnitude imposed across the isolation barrier. See the [Insulation Lifetime](#) section for more details.

² Insulation lifetime for the specified test condition is greater than 50 years.

ABSOLUTE MAXIMUM RATINGS

TRUTH TABLE

Table 20. ADuM220N/ADuM221N/ADuM225N/ADuM226N Truth Table (Positive Logic)

| V_{IX} Input ^{1, 2} | V_{DDI} State ² | V_{DDO} State ² | Default Low (N0), V_{OX} Output ^{1, 2, 3} | Default High (N1), V_{OX} Output ^{1, 2, 3} | Test Conditions/Comments |
|--------------------------------|------------------------------|------------------------------|--|---|--------------------------|
| Low | Powered | Powered | Low | Low | Normal operation |
| High | Powered | Powered | High | High | Normal operation |
| X ⁴ | Unpowered | Powered | Low | High | Fail-safe output |
| X ⁴ | Powered | Unpowered | Indeterminate | Indeterminate | Fail-safe output |

¹ X means don't care.

² V_{IX} and V_{OX} refer to the input and output signals of a given channel (A or B). V_{DDI} and V_{DDO} refer to the supply voltages on the input and output sides of the given channel, respectively.

³ N0 refers to the ADuM220N0/ADuM221N0/ADuM225N0/ADuM226N0 models, and N1 refers to the ADuM220NN1/ADuM221N1/ADuM225N1/ADuM226N1 models. See the [Ordering Guide](#) section.

⁴ Input pins (V_{IX}) on the same side as an unpowered supply must be in a low state to avoid powering the device through its ESD protection circuitry.

PIN CONFIGURATIONS AND FUNCTION DESCRIPTIONS

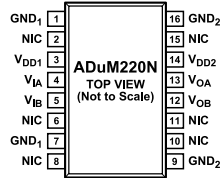

- NOTES
 1. NIC = NO INTERNAL CONNECTION.
 2. PIN 1 AND PIN 7 ARE INTERNALLY CONNECTED, AND CONNECTING BOTH TO GND₁ IS RECOMMENDED.
 3. PIN 9 AND PIN 16 ARE INTERNALLY CONNECTED, AND CONNECTING BOTH TO GND₂ IS RECOMMENDED.

Figure 7. ADuM220N Pin Configuration

Table 21. ADuM220N Pin Function Descriptions¹

| Pin No. | Mnemonic | Description |
|---------|------------------|--|
| 1 | GND ₁ | Ground 1. Ground reference for Isolator Side 1. Pin 1 and Pin 7 are internally connected, and connecting both to GND ₁ is recommended. |
| 2 | NIC | No Internal Connection. Leave this pin floating. |
| 3 | V _{DD1} | Supply Voltage for Isolator Side 1. |
| 4 | V _{IA} | Logic Input A. |
| 5 | V _{IB} | Logic Input B. |
| 6 | NIC | No Internal Connection. Leave this pin floating. |
| 7 | GND ₁ | Ground 1. Ground reference for Isolator Side 1. Pin 1 and Pin 7 are internally connected, and connecting both to GND ₁ is recommended. |
| 8 | NIC | No Internal Connection. Leave this pin floating. |
| 9 | GND ₂ | Ground 2. Ground reference for Isolator Side 2. Pin 9 and Pin 16 are internally connected, and connecting both to GND ₂ is recommended. |
| 10 | NIC | No Internal Connection. Leave this pin floating. |
| 11 | NIC | No Internal Connection. Leave this pin floating. |
| 12 | V _{OB} | Logic Output B. |
| 13 | V _{OA} | Logic Output A. |
| 14 | V _{DD2} | Supply Voltage for Isolator Side 2. |
| 15 | NIC | No Internal Connection. Leave this pin floating. |
| 16 | GND ₂ | Ground 2. Ground reference for Isolator Side 2. Pin 9 and Pin 16 are internally connected, and connecting both to GND ₂ is recommended. |

¹ Reference the AN-1109 Application Note for specific layout guidelines.

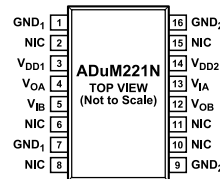

- NOTES
 1. NIC = NO INTERNAL CONNECTION.
 2. PIN 1 AND PIN 7 ARE INTERNALLY CONNECTED, AND CONNECTING BOTH TO GND₁ IS RECOMMENDED.
 3. PIN 9 AND PIN 16 ARE INTERNALLY CONNECTED, AND CONNECTING BOTH TO GND₂ IS RECOMMENDED.

Figure 8. ADuM221N Pin Configuration

Table 22. ADuM221N Pin Function Descriptions¹

| Pin No. | Mnemonic | Description |
|---------|------------------|---|
| 1 | GND ₁ | Ground 1. Ground reference for Isolator Side 1. Pin 1 and Pin 7 are internally connected, and connecting both to GND ₁ is recommended. |
| 2 | NIC | No Internal Connection. Leave this pin floating. |
| 3 | V _{DD1} | Supply Voltage for Isolator Side 1. |

PIN CONFIGURATIONS AND FUNCTION DESCRIPTIONS

Table 22. ADuM221N Pin Function Descriptions¹ (Continued)

| Pin No. | Mnemonic | Description |
|---------|------------------|--|
| 4 | V _{OA} | Logic Output A. |
| 5 | V _{IB} | Logic Input B. |
| 6 | NIC | No Internal Connection. Leave this pin floating. |
| 7 | GND ₁ | Ground 1. Ground reference for Isolator Side 1. Pin 1 and Pin 7 are internally connected, and connecting both to GND ₁ is recommended. |
| 8 | NIC | No Internal Connection. Leave this pin floating. |
| 9 | GND ₂ | Ground 2. Ground reference for Isolator Side 2. Pin 9 and Pin 16 are internally connected, and connecting both to GND ₂ is recommended. |
| 10 | NIC | No Internal Connection. Leave this pin floating. |
| 11 | NIC | No Internal Connection. Leave this pin floating. |
| 12 | V _{OB} | Logic Output B. |
| 13 | V _{IA} | Logic Input A. |
| 14 | V _{DD2} | Supply Voltage for Isolator Side 2. |
| 15 | NIC | No Internal Connection. Leave this pin floating. |
| 16 | GND ₂ | Ground 2. Ground reference for Isolator Side 2. Pin 9 and Pin 16 are internally connected, and connecting both to GND ₂ is recommended. |

¹ Reference the [AN-1109 Application Note](#) for specific layout guidelines.



Figure 9. ADuM225N Pin Configuration

Table 23. ADuM225N Pin Function Descriptions¹

| Pin No. | Mnemonic | Description |
|---------|------------------|---|
| 1 | V _{DD1} | Supply Voltage for Isolator Side 1. |
| 2 | V _{IA} | Logic Input A. |
| 3 | V _{IB} | Logic Input B. |
| 4 | GND ₁ | Ground 1. Ground reference for Isolator Side 1. |
| 5 | GND ₂ | Ground 2. Ground reference for Isolator Side 2. |
| 6 | V _{OB} | Logic Output B. |
| 7 | V _{OA} | Logic Output A. |
| 8 | V _{DD2} | Supply Voltage for Isolator Side 2. |

¹ Reference the [AN-1109 Application Note](#) for specific layout guidelines.



Figure 10. ADuM226N Pin Configuration

Table 24. ADuM226N Pin Function Descriptions¹

| Pin No. | Mnemonic | Description |
|---------|------------------|---|
| 1 | V _{DD1} | Supply Voltage for Isolator Side 1. |
| 2 | V _{OA} | Logic Output A. |
| 3 | V _{IB} | Logic Input B. |
| 4 | GND ₁ | Ground 1. Ground reference for Isolator Side 1. |
| 5 | GND ₂ | Ground 2. Ground reference for Isolator Side 2. |
| 6 | V _{OB} | Logic Output B. |

PIN CONFIGURATIONS AND FUNCTION DESCRIPTIONS**Table 24. ADuM226N Pin Function Descriptions¹ (Continued)**

| Pin No. | Mnemonic | Description |
|---------|------------------|-------------------------------------|
| 7 | V _{IA} | Logic Input A. |
| 8 | V _{DD2} | Supply Voltage for Isolator Side 2. |

¹ Reference the [AN-1109 Application Note](#) for specific layout guidelines.

TYPICAL PERFORMANCE CHARACTERISTICS

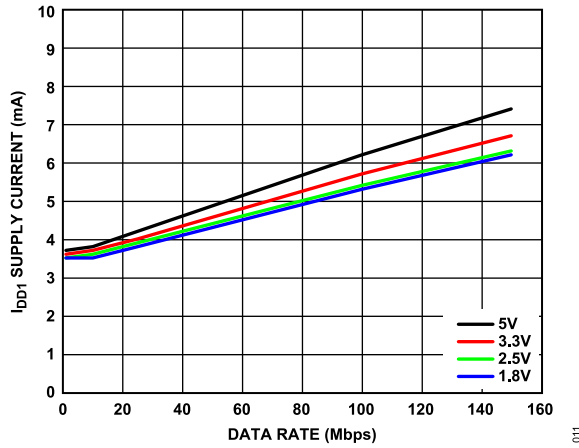

Figure 11. ADuM220N/ADuM225N I_{DD1} Supply Current vs. Data Rate at Various Voltages

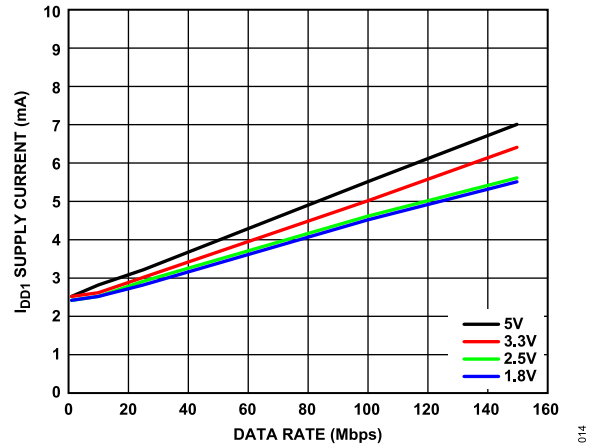

Figure 14. ADuM221N/ADuM226N I_{DD1} Supply Current vs. Data Rate at Various Voltages

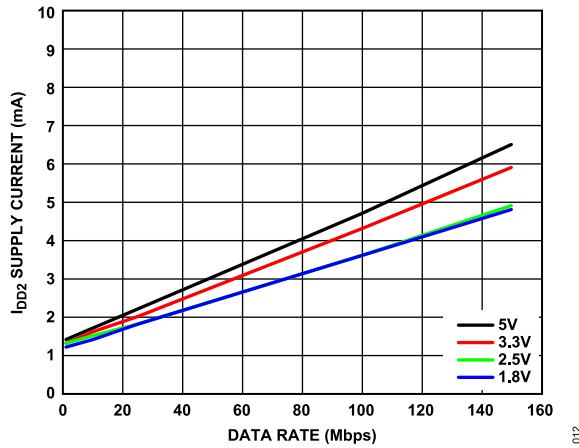

Figure 12. ADuM220N/ADuM225N I_{DD2} Supply Current vs. Data Rate at Various Voltages

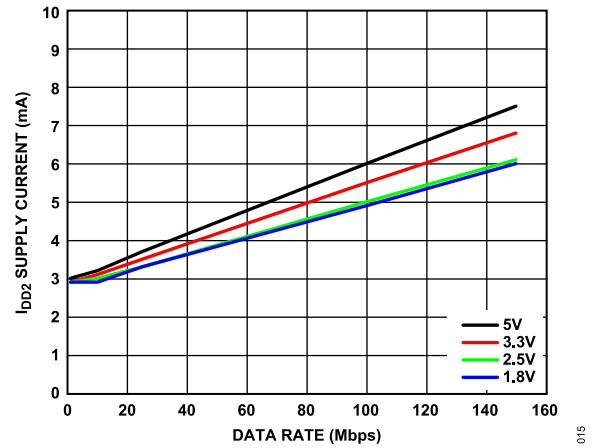

Figure 15. ADuM221N/ADuM226N I_{DD2} Supply Current vs. Data Rate at Various Voltages

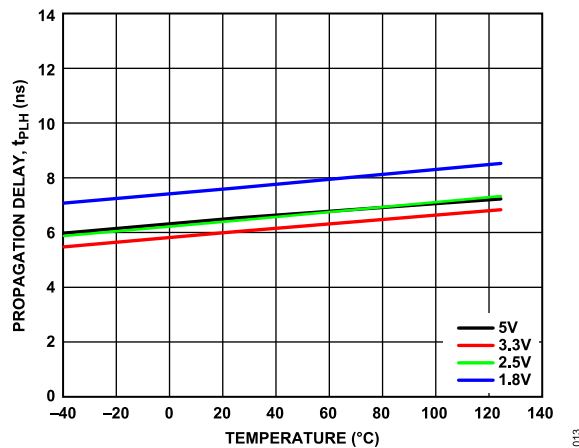

Figure 13. Propagation Delay for Logic High Output (t_{pLH}) vs. Temperature at Various Voltages

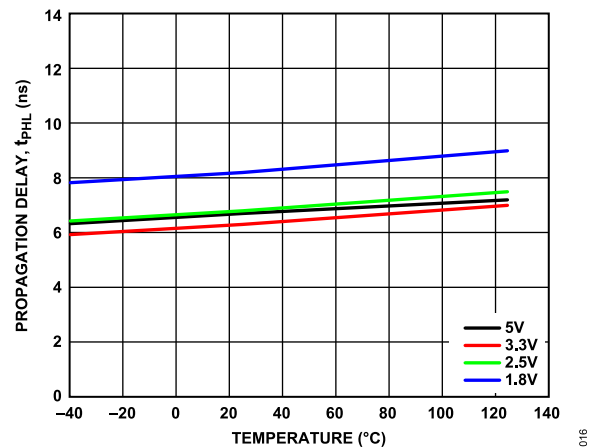

Figure 16. Propagation Delay for Logic Low Output (t_{pHL}) vs. Temperature at Various Voltages

THEORY OF OPERATION

OVERVIEW

The ADuM220N/ADuM221N/ADuM225N/ADuM226N use a high frequency carrier to transmit data across the isolation barrier using iCoupler chip scale transformer coils separated by layers of polyimide isolation. Using an on/off keying (OOK) technique and the differential architecture shown in Figure 17 and Figure 18, the ADuM220N/ADuM221N/ADuM225N/ADuM226N have very low propagation delay and high speed. Internal regulators and input/output design techniques allow logic and supply voltages over a wide range from 1.7 V to 5.5 V, offering voltage translation of 1.8 V, 2.5 V, 3.3 V, and 5 V logic. The architecture is designed for high common-mode transient immunity and high immunity to electrical noise and magnetic interference. Radiated emissions are minimized with a spread spectrum OOK carrier and other techniques.

Figure 17 illustrates the waveforms for models of the ADuM220N/ADuM221N/ADuM225N/ADuM226N that have the condition of the fail-safe output state equal to low, where the carrier waveform is off when the input state is low. If the input side is off or not operating, the fail-safe output state of low (ADuM220N0/ADuM221N0/ADuM225N0/ADuM226N0 models) sets the output to low. For the ADuM220N/ADuM221N/ADuM225N/ADuM226N that have a fail-safe output state of high, Figure 18 illustrates the conditions where the carrier waveform is off when the input state is high. When the input side is off or not operating, the fail-safe output state of high (ADuM220N1/ADuM221N1/ADuM225N1/ADuM226N1) sets the output to high. See the Ordering Guide for the model numbers that have the fail-safe output state of low or the fail-safe output state of high.

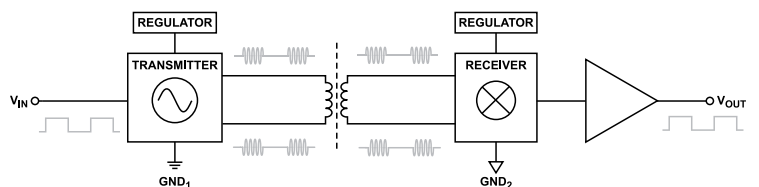

Figure 17. Operational Block Diagram of a Single Channel with a Low Fail-Safe Output State

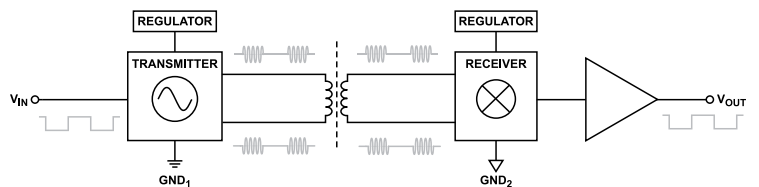

Figure 18. Operational Block Diagram of a Single Channel with a High Fail-Safe Output State

APPLICATIONS INFORMATION

PCB LAYOUT

The ADuM220N/ADuM221N/ADuM225N/ADuM226N digital isolators require no external interface circuitry for the logic interfaces. Power supply bypassing is strongly recommended at the input and output supply pins (see [Figure 19](#) and [Figure 20](#)). For the ADuM225N/ADuM226N, bypass capacitors are most conveniently connected between Pin 1 and Pin 4 for V_{DD1} and between Pin 5 and Pin 8 for V_{DD2} . For the ADuM220N/ADuM221N, bypass capacitors are most conveniently connected between Pin 1 and Pin 3 for V_{DD1} and between Pin 14 and Pin 16 for V_{DD2} . The recommended bypass capacitor value is between 0.01 μF and 0.1 μF . The total lead length between both ends of the capacitor and the input power supply pin must not exceed 10 mm. For the ADuM220N/ADuM221N, bypassing between Pin 3 and Pin 7 and between Pin 9 and Pin 14 must also be considered, unless the ground pair on each package side are connected close to the package.

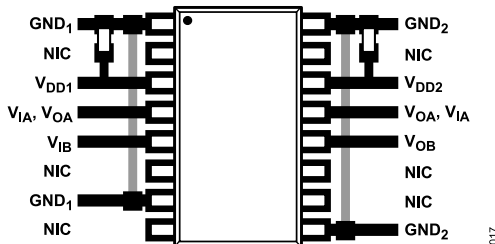

Figure 19. Recommended PCB Layout for ADuM220N/ADuM221N

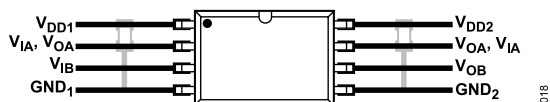

Figure 20. Recommended PCB Layout for ADuM225N/ADuM226N

In applications involving high common-mode transients, ensure that board coupling across the isolation barrier is minimized. Furthermore, design the board layout such that any coupling that does occur equally affects all pins on a given component side. Failure to ensure this can cause voltage differentials between pins exceeding the [Absolute Maximum Ratings](#) of the device, thereby leading to latch-up or permanent damage.

See the [AN-1109 Application Note](#) for board layout guidelines.

PROPAGATION DELAY RELATED PARAMETERS

Propagation delay is a parameter that describes the time it takes a logic signal to propagate through a component. The propagation delay to a Logic 0 output may differ from the propagation delay to a Logic 1 output.

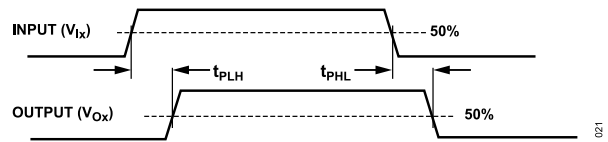

Figure 21. Propagation Delay Parameters

Pulse width distortion is the maximum difference between these two propagation delay values and is an indication of how accurately the timing of the input signal is preserved.

Channel matching is the maximum amount the propagation delay differs between channels within a single ADuM220N/ADuM221N/ADuM225N/ADuM226N component.

Propagation delay skew is the maximum amount the propagation delay differs between multiple ADuM220N/ADuM221N/ADuM225N/ADuM226N components operating under the same conditions.

JITTER MEASUREMENT

[Figure 22](#) shows the eye diagram for the ADuM220N/ADuM221N/ADuM225N/ADuM226N. The measurement was taken using an Agilent 81110A pulse pattern generator at 150 Mbps with pseudorandom bit sequences (PRBS) $2(n-1)$, $n=14$, for 5 V supplies. Jitter was measured with the Tektronix Model 5104B oscilloscope, 1 GHz, 10 GSPS with the DPOJET jitter and eye diagram analysis tools. The result shows a typical measurement on the ADuM220N/ADuM221N/ADuM225N/ADuM226N with 380 ps p-p jitter.

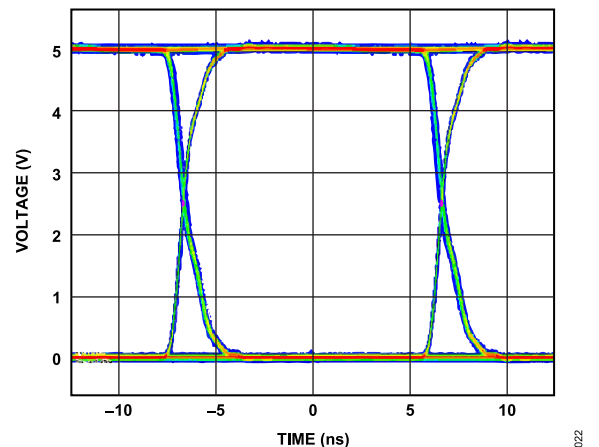

Figure 22. ADuM220N/ADuM221N/ADuM225N/ADuM226N Eye Diagram

INSULATION LIFETIME

All insulation structures eventually break down when subjected to voltage stress over a sufficiently long period. The rate of insulation degradation is dependent on the characteristics of the voltage waveform applied across the insulation as well as on the materials and material interfaces.

APPLICATIONS INFORMATION

The two types of insulation degradation of primary interest are breakdown along surfaces exposed to the air and insulation wear out. Surface breakdown is the phenomenon of surface tracking, and the primary determinant of surface creepage requirements in system level standards. Insulation wear out is the phenomenon where charge injection or displacement currents inside the insulation material cause long-term insulation degradation.

Surface Tracking

Surface tracking is addressed in electrical safety standards by setting a minimum surface creepage based on the working voltage, the environmental conditions, and the properties of the insulation material. Safety agencies perform characterization testing on the surface insulation of components that allows the components to be categorized in different material groups. Lower material group ratings are more resistant to surface tracking and, therefore, can provide adequate lifetime with smaller creepage. The minimum creepage for a given working voltage and material group is in each system level standard and is based on the total rms voltage across the isolation, pollution degree, and material group. The material group and creepage for the ADuM220N/ADuM221N/ADuM225N/ADuM226N isolators are presented in [Table 9](#) and [Table 10](#).

Insulation Wear Out

The lifetime of insulation caused by wear out is determined by its thickness, material properties, and the voltage stress applied. It is important to verify that the product lifetime is adequate at the application working voltage. The working voltage supported by an isolator for wear out may not be the same as the working voltage supported for tracking. It is the working voltage applicable to tracking that is specified in most standards.

Testing and modeling show that the primary driver of long-term degradation is displacement current in the polyimide insulation causing incremental damage. The stress on the insulation can be broken down into broad categories, such as dc stress, which causes very little wear out because there is no displacement current, and an ac component time varying voltage stress, which causes wear out.

The ratings in certification documents are usually based on 60 Hz sinusoidal stress because this reflects isolation from line voltage. However, many practical applications have combinations of 60 Hz ac and dc across the barrier as shown in [Equation 1](#). Because only the ac portion of the stress causes wear out, the equation can be rearranged to solve for the ac rms voltage, as is shown in [Equation 2](#). For insulation wear out with the polyimide materials used in these products, the ac rms voltage determines the product lifetime.

$$V_{RMS} = \sqrt{V_{AC\ RMS}^2 + V_{DC}^2} \quad (1)$$

or

$$V_{AC\ RMS} = \sqrt{V_{RMS}^2 - V_{DC}^2} \quad (2)$$

where:

V_{RMS} is the total rms working voltage.

$V_{AC\ RMS}$ is the time varying portion of the working voltage.

V_{DC} is the dc offset of the working voltage.

Calculation and Use of Parameters Example

The following example frequently arises in power conversion applications. Assume that the line voltage on one side of the isolation is 240 V ac rms and a 400 V dc bus voltage is present on the other side of the isolation barrier. The isolator material is polyimide. To establish the critical voltages in determining the creepage, clearance and lifetime of a device, see [Table 18](#) and [Table 19](#) and the following equations.

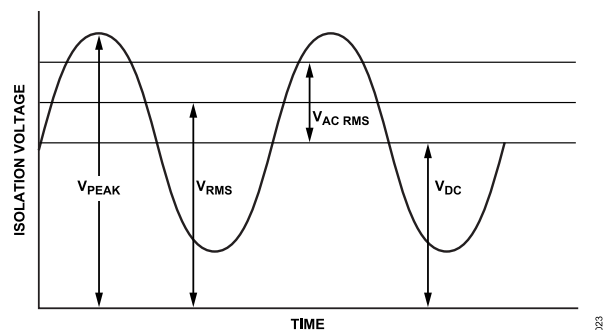

Figure 23. Critical Voltage Example

The working voltage across the barrier from [Equation 1](#) is

$$V_{RMS} = \sqrt{V_{AC\ RMS}^2 + V_{DC}^2}$$

$$V_{RMS} = \sqrt{240^2 + 400^2}$$

$$V_{RMS} = 466\text{ V}$$

This V_{RMS} value is the working voltage used together with the material group and pollution degree when looking up the creepage required by a system standard.

To determine if the lifetime is adequate, obtain the time varying portion of the working voltage. To obtain the ac rms voltage, use [Equation 2](#).

$$V_{AC\ RMS} = \sqrt{V_{RMS}^2 - V_{DC}^2}$$

$$V_{AC\ RMS} = \sqrt{466^2 - 400^2}$$

$$V_{AC\ RMS} = 240\text{ V rms}$$

In this case, the ac rms voltage is simply the line voltage of 240 V rms. This calculation is more relevant when the waveform is not sinusoidal. The value is compared to the limits for the continuous working voltage in [Table 18](#) and [Table 19](#) for the expected lifetime, less than a 60 Hz sine wave, and it is well within the limit for a 50-year service life.

APPLICATIONS INFORMATION

Note that the dc working voltage limits in [Table 18](#) and [Table 19](#) are set by the creepage of the package as specified in IEC 60664-1. These values can differ for specific system level standards.

OUTLINE DIMENSIONS

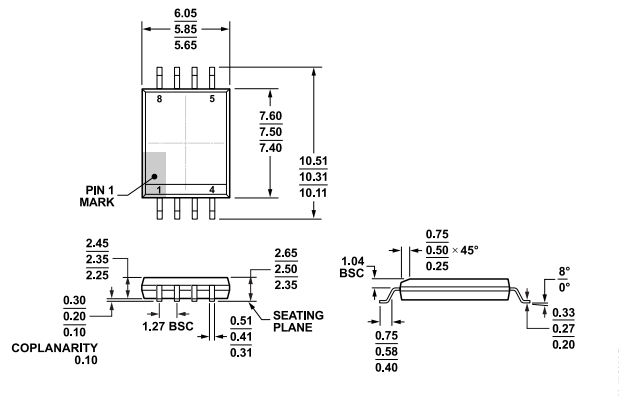
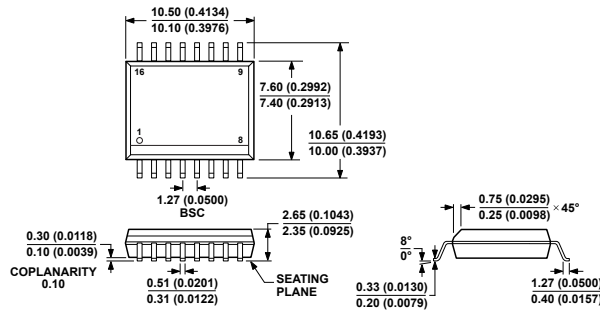

Figure 24. 8-Lead Standard Small Outline Package, with Increased Creepage [SOIC_IC]
Wide Body
(RI-8-1)
Dimensions shown in millimeters



COMPLIANT TO JEDEC STANDARDS MS-013-AA
CONTROLLING DIMENSIONS ARE IN MILLIMETERS; INCH DIMENSIONS
(IN PARENTHESES) ARE ROUNDED-OFF MILLIMETER EQUIVALENTS FOR
REFERENCE ONLY AND ARE NOT APPROPRIATE FOR USE IN DESIGN.

Figure 25. 16-Lead Standard Small Outline Package [SOIC_W]
Wide Body
(RW-16)
Dimensions shown in millimeters and (inches)

OUTLINE DIMENSIONS

Updated: November 22, 2023

ORDERING GUIDE

| Model ^{1, 2} | Temperature Range | Package Description | Packing Quantity | Package Option |
|-----------------------|-------------------|----------------------------------|------------------|----------------|
| ADUM220N0BRWZ | -40°C to +125°C | 16-Lead SOIC Wide | | RW-16 |
| ADUM220N0BRWZ-RL | -40°C to +125°C | 16-Lead SOIC Wide | Reel, 1000 | RW-16 |
| ADUM220N1BRWZ | -40°C to +125°C | 16-Lead SOIC Wide | | RW-16 |
| ADUM220N1BRWZ-RL | -40°C to +125°C | 16-Lead SOIC Wide | Reel, 1000 | RW-16 |
| ADUM221N0BRWZ | -40°C to +125°C | 16-Lead SOIC Wide | | RW-16 |
| ADUM221N0BRWZ-RL | -40°C to +125°C | 16-Lead SOIC Wide | Reel, 1000 | RW-16 |
| ADUM221N0WBRWZ | -40°C to +125°C | 16-Lead SOIC Wide | | RW-16 |
| ADUM221N0WBRWZ-RL | -40°C to +125°C | 16-Lead SOIC Wide | Reel, 1000 | RW-16 |
| ADUM221N1BRWZ | -40°C to +125°C | 16-Lead SOIC Wide | | RW-16 |
| ADUM221N1BRWZ-RL | -40°C to +125°C | 16-Lead SOIC Wide | Reel, 1000 | RW-16 |
| ADUM225N0BRIZ | -40°C to +125°C | 8-Lead SOIC (Increased Creepage) | | RI-8-1 |
| ADUM225N0BRIZ-RL | -40°C to +125°C | 8-Lead SOIC (Increased Creepage) | Reel, 1500 | RI-8-1 |
| ADUM225N1BRIZ | -40°C to +125°C | 8-Lead SOIC (Increased Creepage) | | RI-8-1 |
| ADUM225N1BRIZ-RL | -40°C to +125°C | 8-Lead SOIC (Increased Creepage) | Reel, 1500 | RI-8-1 |
| ADUM226N0BRIZ | -40°C to +125°C | 8-Lead SOIC (Increased Creepage) | | RI-8-1 |
| ADUM226N0BRIZ-RL | -40°C to +125°C | 8-Lead SOIC (Increased Creepage) | Reel, 1500 | RI-8-1 |
| ADUM226N0WBRIZ | -40°C to +125°C | 8-Lead SOIC (Increased Creepage) | | RI-8-1 |
| ADUM226N0WBRIZ-RL | -40°C to +125°C | 8-Lead SOIC (Increased Creepage) | Reel, 1500 | RI-8-1 |
| ADUM226N1BRIZ | -40°C to +125°C | 8-Lead SOIC (Increased Creepage) | | RI-8-1 |
| ADUM226N1BRIZ-RL | -40°C to +125°C | 8-Lead SOIC (Increased Creepage) | Reel, 1500 | RI-8-1 |

¹ Z = RoHS Compliant Part.² W = Qualified for Automotive Applications.NO. OF INPUTS, V_{DD1} AND V_{DD2} SIDE OPTIONS

| Model ^{1, 2} | No. of Inputs, V _{DD1} Side | No. of Inputs, V _{DD2} Side |
|-----------------------|--------------------------------------|--------------------------------------|
| ADUM220N0BRWZ | 2 | 0 |
| ADUM220N0BRWZ-RL | 2 | 0 |
| ADUM220N1BRWZ | 2 | 0 |
| ADUM220N1BRWZ-RL | 2 | 0 |
| ADUM221N0BRWZ | 1 | 1 |
| ADUM221N0BRWZ-RL | 1 | 1 |
| ADUM221N0WBRWZ | 1 | 1 |
| ADUM221N0WBRWZ-RL | 1 | 1 |
| ADUM221N1BRWZ | 1 | 1 |
| ADUM221N1BRWZ-RL | 1 | 1 |
| ADUM225N0BRIZ | 2 | 0 |
| ADUM225N0BRIZ-RL | 2 | 0 |
| ADUM225N1BRIZ | 2 | 0 |
| ADUM225N1BRIZ-RL | 2 | 0 |
| ADUM226N0BRIZ | 1 | 1 |
| ADUM226N0BRIZ-RL | 1 | 1 |
| ADUM226N0WBRIZ | 1 | 1 |
| ADUM226N0WBRIZ-RL | 1 | 1 |
| ADUM226N1BRIZ | 1 | 1 |

OUTLINE DIMENSIONS

| Model ^{1, 2} | No. of Inputs, V _{DD1} Side | No. of Inputs, V _{DD2} Side |
|-----------------------|--------------------------------------|--------------------------------------|
| ADUM226N1BRIZ-RL | 1 | 1 |

¹ Z = RoHS Compliant Part.

² W = Qualified for Automotive Applications

WITHSTAND VOLTAGE RATING (KV RMS) AND FAIL-SAFE OUTPUT STATE OPTIONS

| Model ^{1, 2} | Withstand Voltage Rating (kV rms) | Fail-Safe Output State Options |
|-----------------------|-----------------------------------|--------------------------------|
| ADUM220N0BRWZ | 5.0 | Low |
| ADUM220N0BRWZ-RL | 5.0 | Low |
| ADUM220N1BRWZ | 5.0 | High |
| ADUM220N1BRWZ-RL | 5.0 | High |
| ADUM221N0BRWZ | 5.0 | Low |
| ADUM221N0BRWZ-RL | 5.0 | Low |
| ADUM221N0WBRWZ | 5.0 | Low |
| ADUM221N0WBRWZ-RL | 5.0 | Low |
| ADUM221N1BRWZ | 5.0 | High |
| ADUM221N1BRWZ-RL | 5.0 | High |
| ADUM225N0BRIZ | 5.0 | Low |
| ADUM225N0BRIZ-RL | 5.0 | Low |
| ADUM225N1BRIZ | 5.0 | High |
| ADUM225N1BRIZ-RL | 5.0 | High |
| ADUM226N0BRIZ | 5.0 | Low |
| ADUM226N0BRIZ-RL | 5.0 | Low |
| ADUM226N0WBRIZ | 5.0 | Low |
| ADUM226N0WBRIZ-RL | 5.0 | Low |
| ADUM226N1BRIZ | 5.0 | High |
| ADUM226N1BRIZ-RL | 5.0 | High |

¹ Z = RoHS Compliant Part.

² W = Qualified for Automotive Applications.

AUTOMOTIVE PRODUCTS

The ADuM221N0WBRWZ, ADuM221N0WBRWZ-RL, ADuM226N0WBRIZ, and ADuM226N0WBRIZ-RL models are available with controlled manufacturing to support the quality and reliability requirements of automotive applications. Note that these automotive models may have specifications that differ from the commercial models; therefore, designers should review the [Specifications](#) section of this data sheet carefully. Only the automotive grade products shown are available for use in automotive applications. Contact your local Analog Devices account representative for specific product ordering information and to obtain the specific Automotive Reliability reports for these models.