

FEATURES:

- 7 pin SIP package
- No-load input current as low as 5mA
- Continuous short-circuit protection
- High Efficiency up to 89%
- Unregulated Output Types
- 1.5KVDC ~ 6KVDC Isolation
- Industry Standard Pinout
- Designed to IEC62368, UL62368, EN62368

Specifications typical at TA=25°C nominal input voltage and rated output current unless otherwise specified

Part Number	Input Voltage Range	Output Voltage	Output Current	Efficiency	Capacitive Load μ F
	Vdc	Vdc	mA	%TYP	μ F
EC2-05S052P3	4.5~5.5	5	400	84	2400
EC2-24S152P6	19.2~28.8	15	133	88	220
EC2-05D052P3	4.5~5.5	\pm 5	\pm 200	82	\pm 1200

Note:

1: No suffix is standard isolation (1.5KVDC) e.g., EC2-05S052P
 *add suffix "3" for 3KVDC isolation, *add suffix "4" for 4KVDC isolation,
 *add suffix "5" for 5.2KVDC isolation, *add suffix "6" for 6KVDC isolation

2: Character after "-" is Input Voltage: 12=12Vdc, 15=15Vdc, 24=24Vdc
 e.g., EC2-12S052P, EC2-15S122P3, EC2-24S152P6.



DC-DC Converter EC2-2W Series

2 Watt
1.5KV ~ 6KV Isolated
Single & Dual Output
SIP7

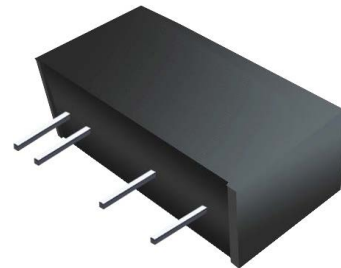

Temperature Derating Graph

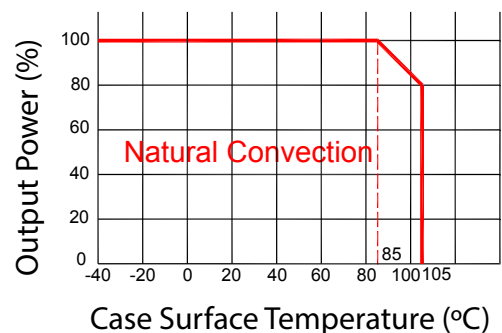

Input Specifications

Parameters	Conditions	Min	Typ	Max	Units
Voltage Range	Vo,lo Nom		±10		%
Filter	Capacitor				

Output Specifications

Parameters	Conditions	Min	Typ	Max	Units
Voltage Tolerance	100% full load			±5	%
Short Circuit Protection	Continuous				
Line Regulation	For 1.0% OF Vin		1.2		%
Load Regulation	5V (10% To 100% F.L)		8	15	%
	9V (10% To 100% F.L)		6	10	%
	12V (10% To 100% F.L)		5	10	%
	15V (10% To 100% F.L)		4	10	%
Ripple & Noise	24V (10% To 100% F.L)		3	10	%
	BW=DC To 20MHz		75	150	mVp-p

General Specifications

Parameters	Conditions	Min	Typ	Max	Units
Isolation Resistance	500Vdc	1000			MΩ
Isolation Capacitance	Input-output, 100KHz/0.1V		20		pF
Switching Frequency	Full load, nominal input @5V Vin		215		KHz
	Full load, nominal input @other Vin		250		KHz
Operating Temperature		-40		+105	°C
Storage Temperature		-55		+125	°C
Humidity	Non Condensing			95	%
Cooling	Free air Convection				
Case Material	DAP				
MTBF	MIL-HDBK-217F@25°C	3,500,000			Hours
Weight			2.1		g
Dimensions			19.5x6.0x10.0		mm

Part Number

EC2 - XX X XX X X X
A B C D E F G

A: Series
B: Input Voltage
C: Single (S) / Dual Output (D)
D: Output Voltage
E: Output Power
F: Protection (P)
G: Isolation Voltage

Tolerance Envelope Graph

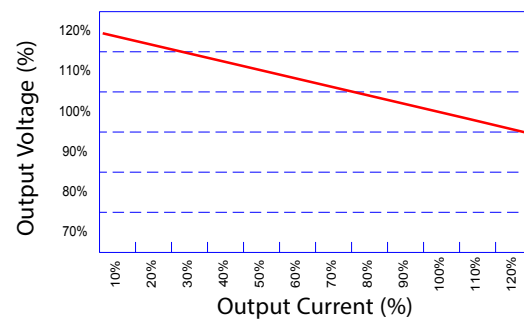

Electromagnetic Compatibility (EMC)

EMI	CE	CISPR32/EN55032 CLASS B (see Fig. 1 for recommended circuit)
	RE	CISPR32/EN55032 CLASS B (see Fig. 1 for recommended circuit)
EMS	ESD	IEC/EN61000-4-2 Air ±8kV , Contact ±4kV perf. Criteria B

Packaging

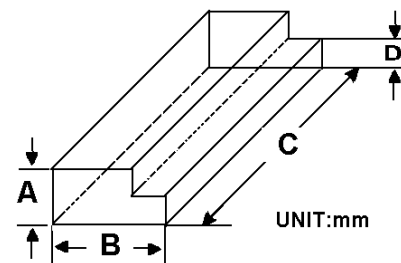

Size (mm)			
A	B	C	D
9.5	16.5	522	5.0

Recommended Test Circuit

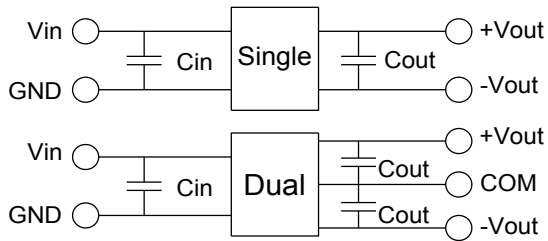

Vin	Cin	Single Vout	Cout	Dual Vout	Cout
5Vdc	4.7μF/25V	5Vdc	10μF/16V	±5Vdc	±4.7μF/16V
12Vdc	2.2μF/25V	9Vdc	2.2μF/16V	±9Vdc	±1μF/16V
15Vdc	2.2μF/25V	12Vdc	2.2μF/25V	±12Vdc	±1μF/25V
24Vdc	1μF/50V	15Vdc	1μF/25V	±15Vdc	±1μF/25V
--	--	24Vdc	1μF/50V	±24Vdc	±1μF/50V

EMC (CLASS B) Compliance Circuit

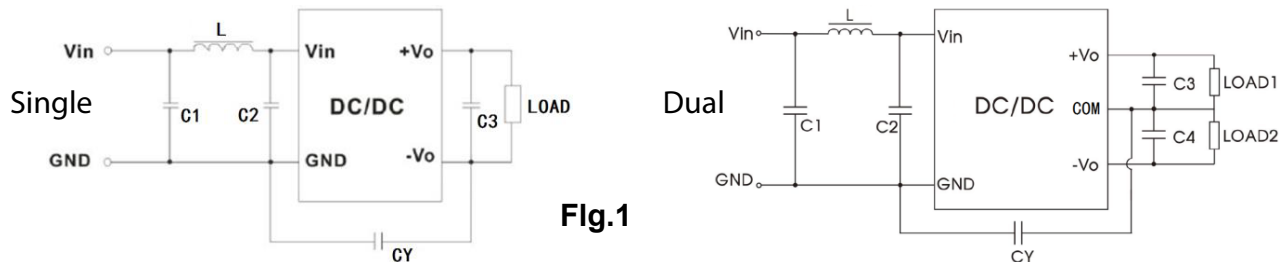
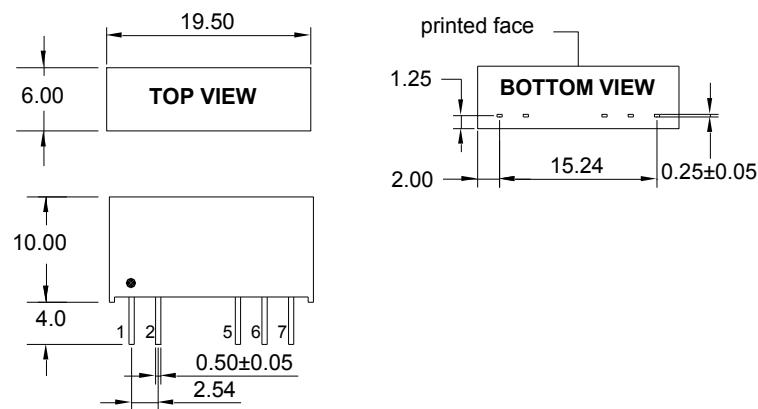

Fig.1

EMC Recommended Circuit Value Table

		C1	4.7μF /50V
EMI	C2	4.7μF /50V	
	CY	1nF/4kV	
	C3	Recommended Test Circuit	
	L	6.8μH	

Markings and Dimensions



UNIT: mm unless otherwise specified, all tolerances are ±0.25

PIN Connection

PIN	1	2	5	6	7
Single	+Vin	-Vin	-Vout	No Pin	+Vout
Dual	+Vin	-Vin	-Vout	Com	+Vout