

Protect future technologies effectively:

with the new tubeaxial fan series AxiForce.

ebmpapst

the engineer's choice



About ebm-papst.

ebm-papst is a leader in ventilation and drive engineering technology and a much sought-after engineering partner in many industries. With around 20,000 different products, we have the perfect solution for practically every requirement. We have placed the highest emphasis on economy and ecology for many years.

We believe the consistent further development of our highly-efficient GreenTech EC technology provides our customers with the best opportunities for the future in industrial digitization. With GreenIntelligence, ebm-papst already offers intelligent networked complete solutions that are unique anywhere in the world today and that secure our customers a decisive advantage.

The logo for ebm-papst, with 'ebm' in black and 'papst' in blue.

the engineer's choice

Six reasons that make us the ideal partner:

Our systems expertise.

You want the best solution for every project. The entire ventilation system must thus be considered as a whole. And that's what we do – with **motor technology** that sets standards, sophisticated **electronics** and **aerodynamic** designs – all from a single source and perfectly matched.

Our spirit of invention.

We are also always able to develop customized solutions for you with our versatile team of over 600 engineers and technicians.

Our lead in technology.

We are not only pioneers and trailblazers in the development of highly efficient EC technology, we also recognized the opportunities of digitization at an early stage. Therefore, we can offer solutions today that combine the highest energy efficiency with the advantages of IoT and digital networking.

Closeness to our customers.

ebm-papst has 29 production locations worldwide (including facilities in Germany, China and the USA), together with 48 sales offices, each of which has a dense network of sales representatives. You will always have a local contact, someone who speaks your language and knows your market.

Our standard of quality.

Our quality management is uncompromising, at every step in every process. This is underscored by our certification according to international standards including DIN EN ISO 9001, declaration TS of conformity and DIN EN ISO 14001.

Our sustainable approach.

Assuming responsibility for the environment, for our employees and for society is an integral part of our corporate philosophy. We develop products with an eye to maximum environmental compatibility, in particular resource-preserving production methods. We promote environmental awareness among our young staff and are actively involved in sports, culture and education. That's what makes us a leading company – and an ideal partner for you.

Efficient and quiet: *The new AxiForce.*

With the new AxiForce, ebm-papst is consolidating its role as a leader of innovation and is supporting technologies that are indispensable for a modern, networked future. The brain of a complete production line, complex system or mobile network infrastructure is often installed in industrial control cabinets. It almost always contains sensitive electronic and electrical components that have to be consistently and effectively protected from dangerous environmental factors, such as severe temperature fluctuations, for the safe and error-free operation of a whole host of industry applications.

With the AxiForce – more powerful and quiet than ever before – ebm-papst has developed a tubeaxial fan series, which is used to cool control units in automation and other highly-modern technologies, such as 5G power modules, continuously and safely.

Due to its variable installation, high cooling capacity in the smallest of spaces and interactive integration into the device logic, it is already indispensable in modern automation.

Would you like further information?
We would be happy to provide it.

For any questions about the AxiForce,
please contact **Christian Stern**,
Product Management CAT:
Phone: +497724 81-1725
Stern.Christian@de.ebmpapst.com

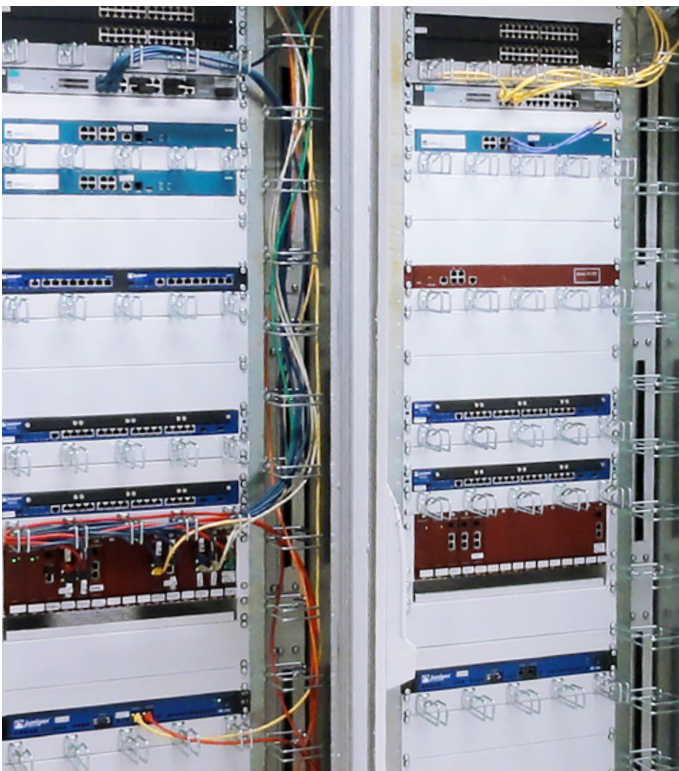

Convincing comprehensive package.

Compact outside, powerful inside.



Performance

- + **Noise advantage**
up to 6 dB (A) as an example at the size 80
- + **Steep air performance curve**
- + **Benchmark**
in air performance and noise
- + **Maximum Efficiency**
Increase by up to 18%

Technology

- + **New aerodynamic design**
of housing and fan impeller
- + **Latest powerful and efficient**
motor technology
- + **Powerful electronics**

Flexibility

- + **Speed signal**
- + **Go/NoGo alarm**
- + **Alarm**
with speed limit
- + **Control inputs**
PWM, analog voltage,
temperature sensor
- + **Salt spray protection**
- + **Degree of protection**
up to IP68

The specialist for installation space: AxiForce size 80



Description

- New developed flow geometry
- New three-phase motor concept
- Powerful electronics
- Air flow direction: Exhaust over struts
- Rotational direction: Counterclockwise, looking towards rotor
- Material Housing: Plastic (PBT)
- Material Impeller: Plastic (PA)
- Tach output
- PWM control input

Optional

- Go/NoGo alarm
- Alarm with speed limit
- Temperature sensor for speed control
- Analog control input
- Salt spray protection
- Degree of protection up to IP68
- EMC class B according to EN55022

More at www.ebmpapst.com/compactfans

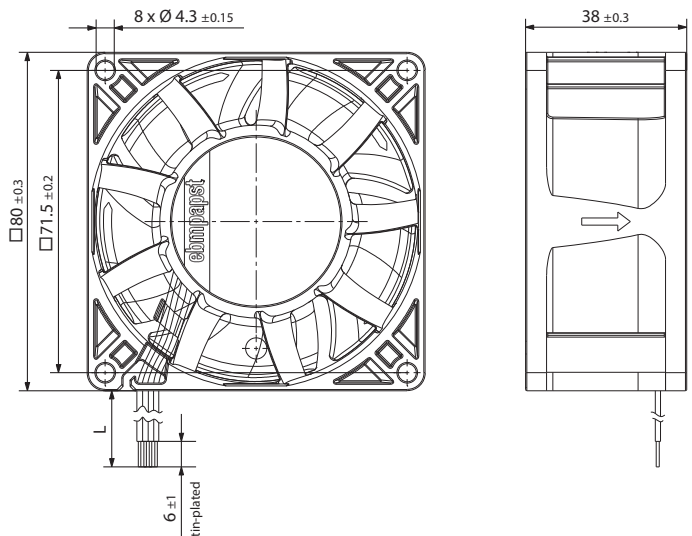
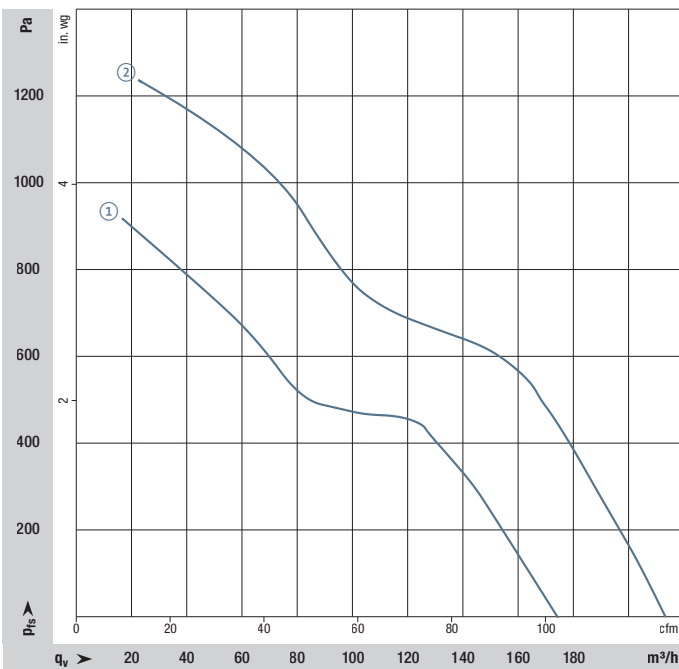

Nominal data

Type	Part no.	Air flow* m³/h	Air flow* cfm	Nominal voltage VDC	Voltage range VDC	Sound pressure dB(A)	Sound power level Bel (A)	Sintered/sliding bearing Ball bearing	Power consumption* Watt	Max. input current Watt	Nominal speed rpm	Temperature range °C	Mass kg	Curve	Powerclass
VWC0080KUFC5	8315100136	175	103	12	8 ... 16	71	7,7	■	26	63	13.200	-20...+75	0,2	①	Medium
VWC0080KUFC5	8315100137	175	103	24	16 ... 32	71	7,7	■	25	62	13.200	-20...+75	0,2	①	Medium
VWC0080KUFC5	8315100138	175	103	48	36 ... 60	71	7,7	■	24	61	13.200	-20...+75	0,2	①	Medium
VWC0080KUFC5	8315100130	215	126,5	12	8 ... 16	76	8,3	■	46	98	16.500	-20...+75	0,2	②	High
VWC0080KUFC5	8315100134	215	126,5	24	16 ... 32	76	8,3	■	44	96	16.500	-20...+75	0,2	②	High
VWC0080KUFC5	8315100135	215	126,5	48	36 ... 60	76	8,3	■	42	94	16.500	-20...+75	0,2	②	High

All dimensions in mm. Data sheets available on request. Subject to technical changes.
*in free air operation

The specialist for noise:

AxiForce size 120



Description

- New developed flow geometry
- New one-phase motor concept
- Powerful electronics
- Air flow direction: Exhaust over struts
- Rotational direction: Counterclockwise, looking towards rotor
- Material Housing: Medium Power: Plastic (PBT), High Power: Aluminum
- Material Impeller: Plastic (PA)
- Tach output
- PWM control input

Optional

- Go/NoGo alarm
- Alarm with speed limit
- Temperature sensor for speed control
- Analog control input
- Salt spray protection
- Degree of protection up to IP68
- EMC class B according to EN55022

More at www.ebmpapst.com/compactfans

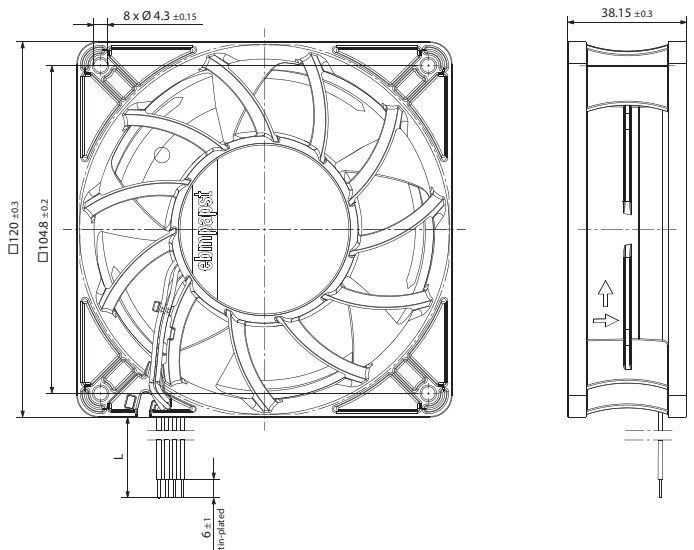
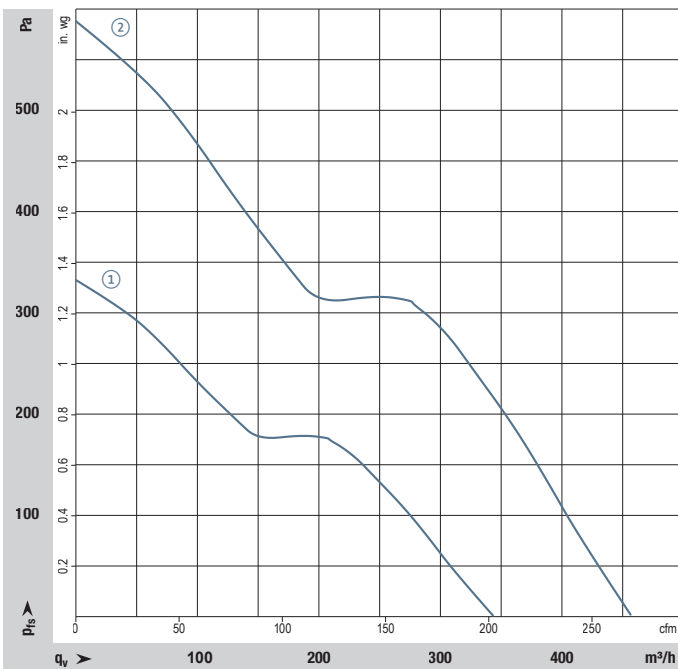

Nominal data

Type	part no.	Air flow* m³/h	Air flow* cfm	Nominal voltage VDC	Voltage range VDC	Sound pressure dB(A)	Sound power level Bel (A)	Sintered sliding bearing Ball bearing	Power consumption* Watt	Max. input current Watt	Nominal speed rpm	Temperature range °C	Mass kg	Curve	Powerclass
VWC0120KUJBS	8315100143	345	203	12	10,8...13,2	59	7,0	■	30	35	6.500	-20...+70	0,3	①	Medium
VWC0120KUJBS	8315100142	345	203	24	16...28	59	7,0	■	30	35	6.500	-20...+70	0,3	①	Medium
VWC0120KUJBS	8315100144	345	203	48	36...60	59	7,0	■	30	35	6.500	-20...+70	0,3	①	Medium
VWC0120KUJBS	8315100183	462	272	24	16...30	66	7,7	■	65	120	8.700	-20...+70	0,4	②	High
VWC0120KUJBS	8315100145	462	272	48	36...60	66	7,7	■	65	120	8.700	-20...+70	0,4	②	High

All dimensions in mm. Data sheets available on request. Subject to technical changes.
*in free air operation

The specialist for pressure: AxiForce size 172



Description

- New developed flow geometry
- New three-phase motor concept
- Powerful electronics
- Air flow direction: Exhaust over struts
- Rotational direction: Counterclockwise, looking towards rotor
- Material Housing: Aluminum
- Material Impeller: Plastic (PA)
- Tach output
- PWM control input

Optional

- Go/NoGo alarm
- Alarm with speed limit
- Temperature sensor for speed control
- Analog control input
- Salt spray protection
- Degree of protection up to IP68

More at www.ebmpapst.com/compactfans

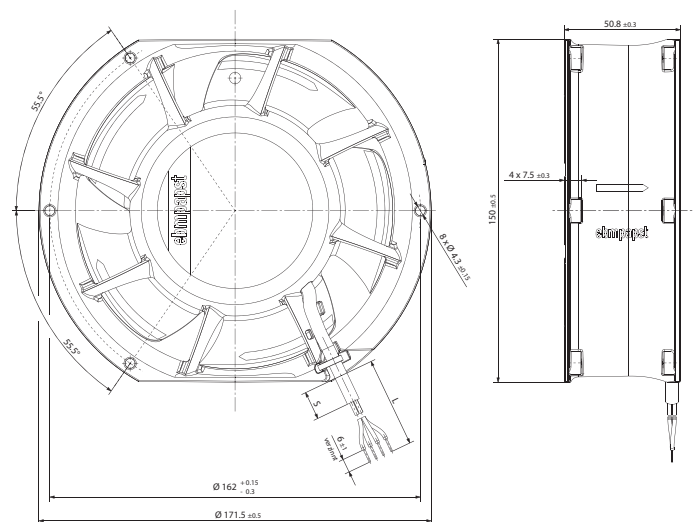
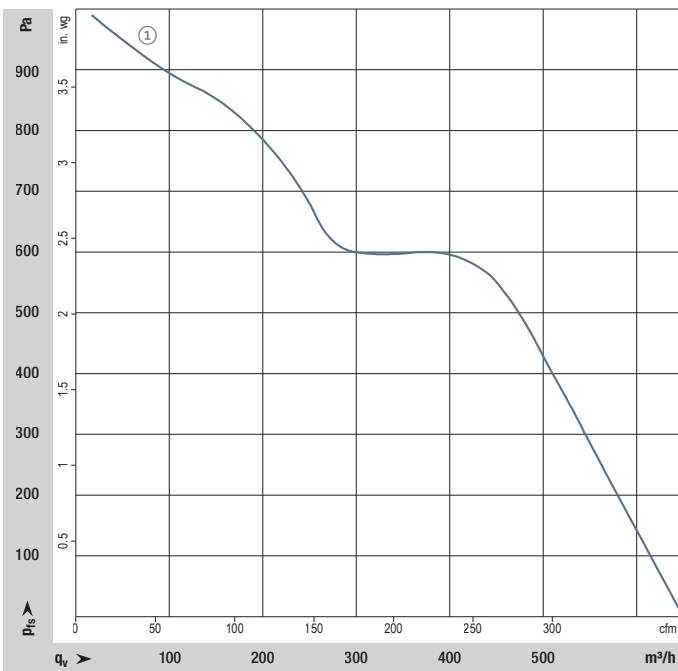

Nominal data

Type	part no.	Air flow* m³/h	Air flow* cfm	Nominal voltage VDC	Voltage range VDC	Sound pressure dB(A)	Sound power level Bel (A)	Sintered sliding bearing Ball bearing	Power consumption* Watt	Max. input current Watt	Nominal speed rpm	Temperature range °C	Mass kg	Curve	Powerclass
VWG0138KULCS	8315100059	650	382	48	36...72	70	8,2	■	98	170	8.300	-20...+70	0,9	①	High

All dimensions in mm. Data sheets available on request. Subject to technical changes. 12 VDC and 24 VDC versions will follow soon.
*in free air operation.

ebmpapst

the engineer's choice

ebm-papst
St. Georgen GmbH & Co. KG

Hermann-Papst-Straße 1
78112 St. Georgen
Germany
Phone +49 7724-810
Fax +49 7724-811309
info2@de.ebmpapst.com