

TMR7302-E

Integrated Current Sensor

Description

TMR7302-E is based on the open loop integrated current sensor for measuring DC, AC, pulsed current and arbitrary waveform current with galvanic isolation and its internal temperature compensation circuitry provides excellent performance under different ambient temperature ranges.

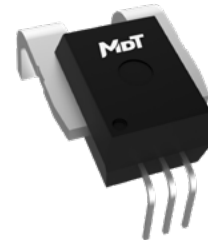

Features and Benefits

- Open loop principle
- High accuracy
- Small size, simple structure
- Excellent temperature stability

Applications

- Power supplies for welding application
- Inverter and variable frequency drives (VFD)
- DC motor drive
- Overcurrent protection

Selection Guide

Model	Supply Voltage	Primary Current Measuring Range	Sensitivity
TMR7302-050E/PFF5BB	5 V	±50 A	40 mV/A
TMR7302-100E/PFF5BB	5 V	±100 A	20 mV/A
TMR7302-150E/PFF5BB	5 V	±150 A	13.33 mV/A
TMR7302-200E/PFF5BB	5 V	±200 A	10 mV/A
TMR7302-250E/PFF5BB	5 V	±250 A	8 mV/A

Insulation and Environmental Characteristics

Parameters	Symbol	Typical	Unit
Supply Voltage (absolute maximum)	V_{CC}	7	V
Dielectric Strength	V_D	4.8	kV(50Hz, 1min)
Creepage Distance	d_{CP}	7.25	mm
Clearance	d_{CL}	7.25	mm
ESD Performance (HBM)	V_{ESD}	4	kV
Ambient Operating Temperature	T_A	-40 to +125	°C
Ambient Storage Temperature	T_{STG}	-40 to +125	°C
Maximum Junction Temperature	$T_{J(MAX)}$	165	°C

Catalogue

1. Specifications	03
2. Typical Output Characteristics.....	04
3. Parameters Definition and Formula.....	05
4. Dimensions	06
5. Pin Configuration and Wiring Diagram	07
6. Remarks	07
7. Recommended PCB Layout.....	08

1. Specifications

$T_A = 25\text{ }^\circ\text{C}$, $V_{CC} = 5\text{ V}$, $R_L = 10\text{ k}\Omega$, unless otherwise noted

Parameter	Symbol	Conditions	Min.	Typ.	Max.	Unit
General Electrical Data						
Primary Current Measuring Range	I_{PM}	TMR7302-050E/PFF5BB	-50	-	50	A
		TMR7302-100E/PFF5BB	-100	-	100	
		TMR7302-150E/PFF5BB	-150	-	150	
		TMR7302-200E/PFF5BB	-200	-	200	
		TMR7302-250E/PFF5BB	-250	-	250	
Sensitivity	S	TMR7302-050E/PFF5BB	-	40	-	mV/A
		TMR7302-100E/PFF5BB	-	20	-	
		TMR7302-150E/PFF5BB	-	13.33	-	
		TMR7302-200E/PFF5BB	-	10	-	
		TMR7302-250E/PFF5BB	-	8	-	
Supply Voltage	V_{CC}	$\pm 5\%$	4.75	5	5.25	V
Offset Voltage	V_{OFF}	$I_P = 0$	-	2.5	-	V
Output Voltage	V_{OUT}	$I_P = I_{PM(min)}$ to $I_{PM(max)}$	-	$2.5 + I_P \times S$	-	V
Output Saturation Voltage	V_{SATL}	-	0.2	-	-	V
	V_{SATH}	-	-	-	$V_{CC}-0.2$	V
Current Consumption	I_C	$I_P = 0$	-	6.3	7.5	mA
Power ON Time	t_{PO}	$V_{CC} \geq 2.5\text{ V}$	-	40	-	ms
Primary Conductor Input Resistance	R_{IN}	$T_A = 25\text{ }^\circ\text{C}$	-	0.1	-	m Ω
Output Impedance	R_{OUT}	-	-	2	5	Ω
Load Resistance	R_L	-	1	10	-	k Ω
Load Capacitance	C_L	-	-	-	10	nF
Rise Time	t_{rise}	$I_P = 50\text{ A (100 A/}\mu\text{s)}$	-	10	-	μs
Delay Time	t_D	$I_P = 50\text{ A (100 A/}\mu\text{s)}$	-	1	-	μs
Response Time	t_R	$I_P = 50\text{ A (100 A/}\mu\text{s)}$	-	10	-	μs
Bandwidth	BW	Small signal -3 dB	-	50	-	kHz
Noise	V_N	$T_A = 25\text{ }^\circ\text{C}$, BW = 10 kHz	-	20	-	mV _{PP}
Static Performance Data						
Accuracy	X_G	$T_A = 25\text{ }^\circ\text{C}$, $I_P = I_{PM(min)}$ to $I_{PM(max)}$	-2	± 1	2	% $I_{PM(max)}$
		$T_A = -40\text{ }^\circ\text{C to } +125\text{ }^\circ\text{C}$, $I_P = I_{PM(min)}$ to $I_{PM(max)}$	-3.5	± 2	3.5	
Linearity Error	ϵ_L	$I_P = I_{PM(min)}$ to $I_{PM(max)}$	-	0.3	0.5	% $I_{PM(max)}$
Sensitivity Error	ϵ_S	$T_A = 25\text{ }^\circ\text{C}$, $I_P = I_{PM(min)}$ to $I_{PM(max)}$	-1	-	1	%
		$T_A = -40\text{ }^\circ\text{C to } +125\text{ }^\circ\text{C}$, $I_P = I_{PM(min)}$ to $I_{PM(max)}$	-1.5	-	1.5	
Offset Error	V_{OE}	$T_A = 25\text{ }^\circ\text{C}$, $I_P = 0$	-10	-	10	mV
		$T_A = -40\text{ }^\circ\text{C to } +125\text{ }^\circ\text{C}$, $I_P = 0$	-25	-	25	
Hysteresis	V_{OH}	$I_P = I_{PM(min)}$ or $I_{PM(max)} \rightarrow 0$	-	± 3	-	mV

2. Typical Output Characteristics

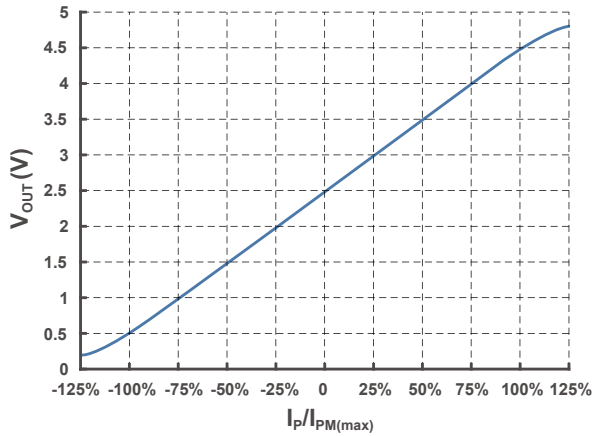

Figure 1. Output voltage vs primary current

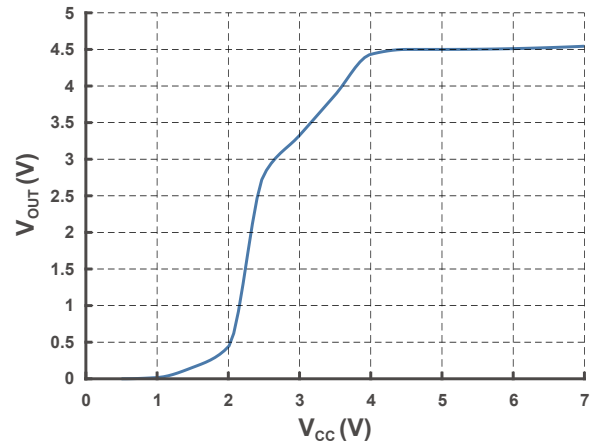

Figure 2. Output voltage vs supply voltage (@ $I_P = I_{PN}$)

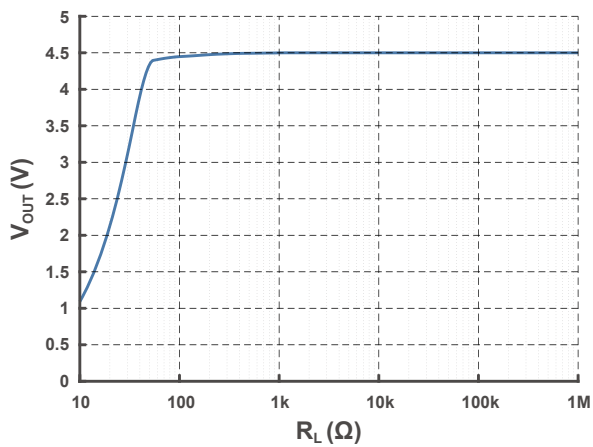

Figure 3. Output voltage vs load resistance (@ $I_P = I_{PN}$)

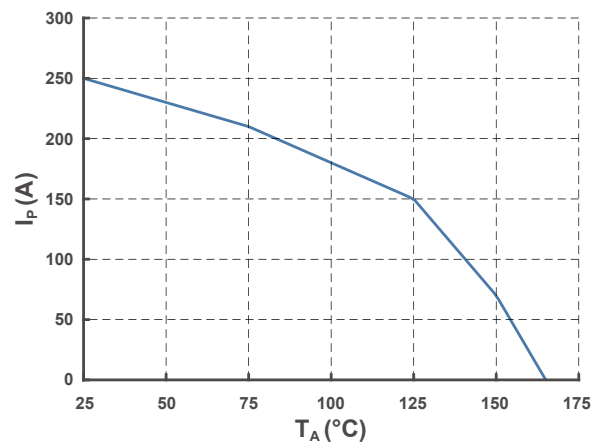

Figure 4. Maximum continuous current (DC)

3. Parameters Definition and Formula

1) Accuracy

$$X_G = \underset{I_p \in [I_{PM (min)}, I_{PM (max)}]}{\text{MAX}} \left(\frac{V_{OUT} - (I_p \times S + V_{OFF})}{I_{PM (max)} \times S} \times 100\% \right)$$

I_p stands for primary current, $I_{PM (max)}$ 、 $I_{PM (min)}$ stands for the maximum and minimum values within primary current measuring range, V_{OUT} stands for current sensor output voltage at given primary current, S stands for sensitivity, V_{OFF} stands for offset voltage.

2) Sensitivity

$$S = \frac{V_{OUT(@ I_{PM (max)})} - V_{OUT(@ I_{PM (min)})}}{2 \times I_{PM (max)}}$$

$V_{OUT(@ I_{PM (max)})}$ 、 $V_{OUT(@ I_{PM (min)})}$ stand for the voltage output at $I_{PM (max)}$ 、 $I_{PM (min)}$ respectively.

3) Offset Error

$$V_{OE} = V_{OUT(@ I_p = 0)} - V_{OFF}$$

4) Linearity

$$\varepsilon_L = \underset{I_p \in [I_{PM (min)}, I_{PM (max)}]}{\text{MAX}} \left(\frac{|V_{OUT} - (I_p \times \bar{S} + V_{OFF} + \overline{V_{OE}})|}{I_{PM (max)} \times S} \times 100\% \right)$$

\bar{S} 、 $\overline{V_{OE}}$ stand for the average values of the sensitivity and offset error.

5) Hysteresis

$$V_{OH} = \text{MAX } \Delta H$$

ΔH is the maximum residual voltage between full scale positive and negative nominal current.

4. Dimensions

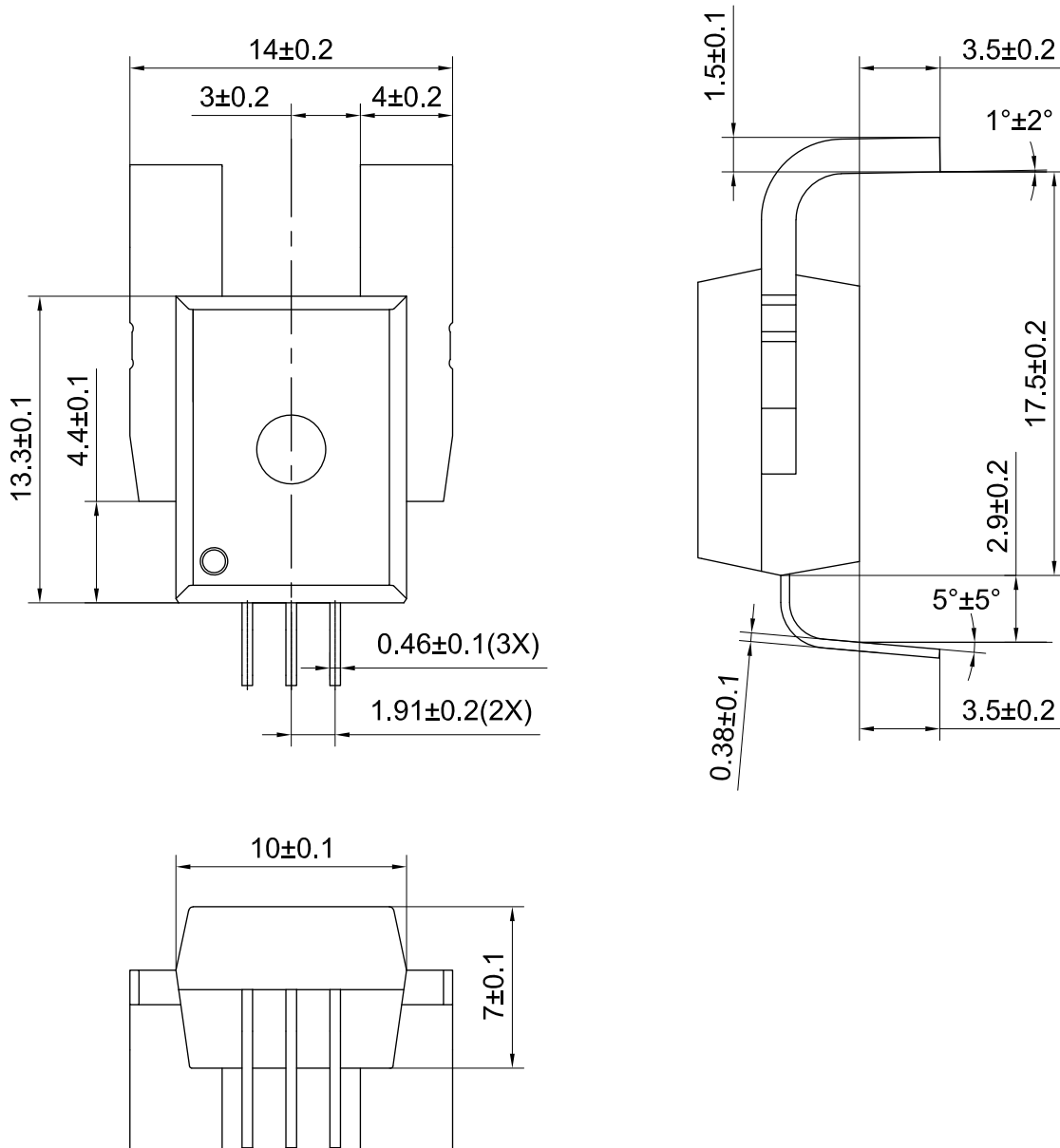
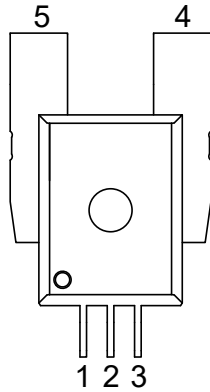

Figure 5. Dimension (unit: mm, tolerances for unmarked scales ± 1 mm)

5. Pin Configuration and Wiring Diagram



Pin Number	Name	Function
1	V_{CC}	Power supply
2	GND	Ground
3	V_{OUT}	Voltage output
4	I_{P+}	Primary current (forward)
5	I_{P-}	Primary current (reverse)

Figure 6. Pin configuration

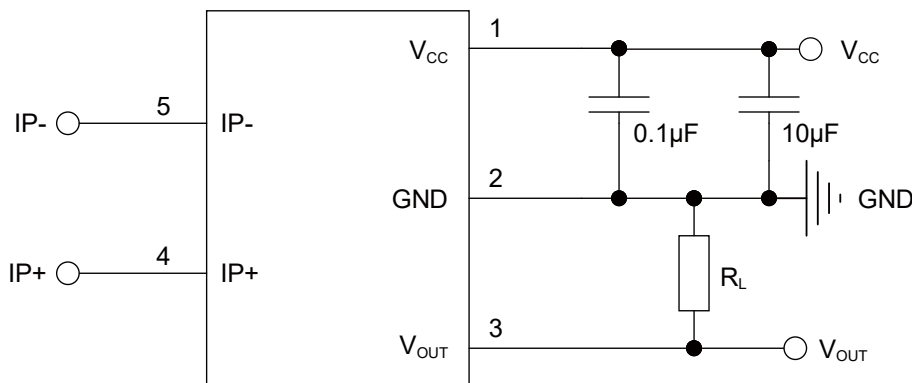

Figure 7. Wiring diagram

6. Remarks

1. Improper connection may result in permanent damage of the sensor.
2. Bandwidth can be adjusted by adding low pass filter (LPF) between V_{OUT} and GND.
3. Sensor is customizable upon request.

7. Recommended PCB Layout

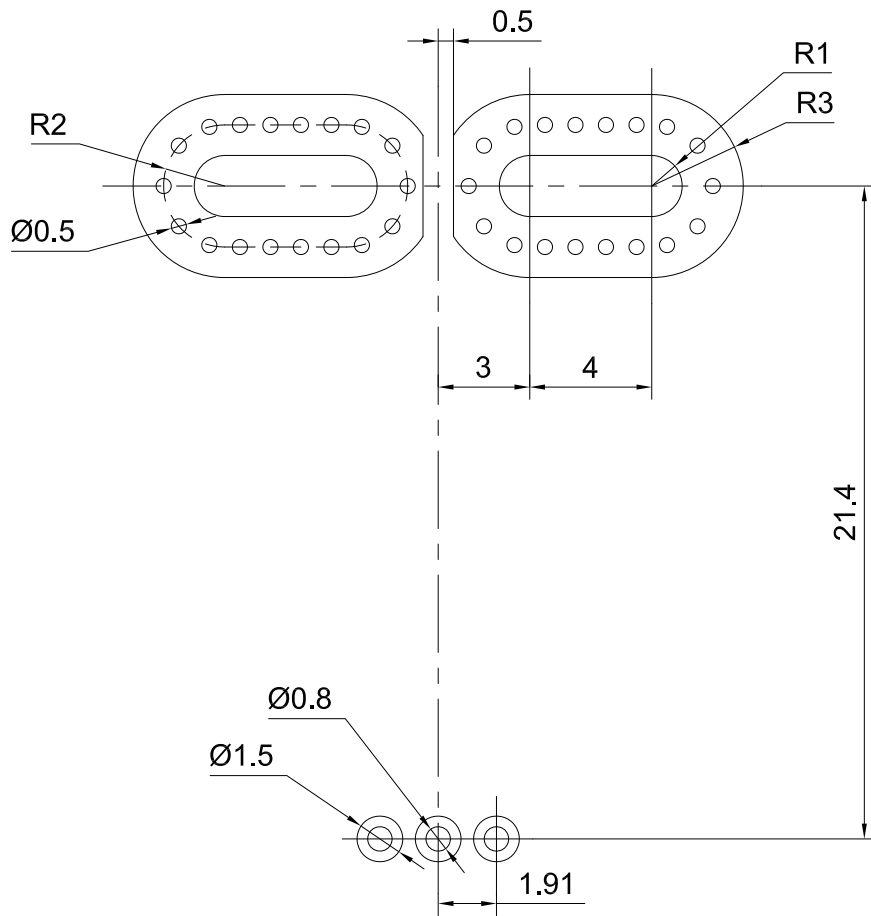

Figure 8. PCB layout

Copyright © 2022 by MultiDimension Technology Co., Ltd.

Information furnished herein by MultiDimension Technology Co., Ltd. (hereinafter MDT) is believed to be accurate and reliable. However, MDT disclaims any and all warranties and liabilities of any kind, with respect to any examples, hints or any performance or use of technical data as described herein and/or any information regarding the application of the product, including without limitation warranties of non-infringement of intellectual property rights of any third party. This document neither conveys nor implies any license under patent or other industrial or intellectual property rights. Customer or any third-party must further determine the suitability of the MDT products for its applications to avoid the applications default of customer or third-party. MDT accept no liability in this respect.

MDT does not assume any liabilities of any indirect, incidental, punitive, special or consequential damages (including without limitation of lost profits, lost savings, business interruption, costs related to the removal or replacement of any products or rework charges) whether or not such damages are based on tort (including negligence), warranty, breach of contract or any other legal theory. Notwithstanding any damages that customer might incur for any reason whatsoever, MDT's aggregate and cumulative liability towards customer for the products described herein shall be limited in accordance with the terms and conditions of commercial sale of MDT.

Absolute maximum ratings are the extreme limits the device will withstand without damage to the MDT product. However, the electrical and mechanical characteristics are not guaranteed as the maximum limits (above recommended operating conditions) are approached. MDT disclaims any and all warranties and liabilities of the MDT product will operate at absolute maximum ratings.

Specifications may change without notice.

Please download latest document from our official website www.dowaytech.com/en.

Recycling

The product(s) in this document need to be handed over to a qualified solid waste management services company for recycling in accordance with relevant regulations on waste classification after the end of the product(s) life.



No.2 Guangdong Road, Zhangjiagang Free Trade Zone, Jiangsu, China

Web: www.dowaytech.com/en E-mail: info@dowaytech.com

