

XtremeSense™ High-Linearity, High-Resolution TMR Current Sensor with FLAG Output in Miniature Form Factor

FEATURES AND BENEFITS

- AC or DC contactless current sensing
- Inherently high isolation
- Magnetic field (current) range:
 - ± 1.5 mT
 - ± 5.0 mT
 - ± 10.0 mT
 - ± 15.0 mT
- Stable performance over temperature
- Supply current: ~ 1.2 mA
- FLAG Pin to indicate 90% and 10% of full field range
 - Active low digital output (push-pull)
- Supply voltage: 2.7 to 5.5 V
- Operating temperature ranges:
 - Industrial: -40°C to 85°C
 - Extended industrial: -40°C to 125°C
- Package: 5-lead SOT23

APPLICATIONS

- Contactless current sensing measurements
- Motor control
- Solar inverters
- Power distribution units (PDUS)
- UPS, SMPS, and telecom power supplies
- Smart appliances
- IoT smart plugs/energy devices
- Battery management systems
- Battery chargers
- PC and servers

DESCRIPTION

The CT220 is a high-linearity and high-resolution contactless current sensor from Allegro developed on its patented XtremeSense™ TMR technology. The CT220 measures the magnetic field of the current flowing through a busbar or printed circuit board (PCB) trace and converts it to an analog output voltage that represents the field and therefore current.

As a contactless current sensor, it has an inherently high isolation, making it an ideal solution for applications where product safety compliance is a requirement due to high operating voltages combined with human interaction with the product. The CT220 achieves XtremeSense performance with a typical total output error of $\pm 0.5\%$ while sensing field (current) as low as 5 mA. The device supports a wide operating voltage range of 2.7 to 5.5 V.

The CT220 is an ideal contactless current sensing solution for applications that must have excellent isolation and accurate current measurements. There are four variants of the CT220 that will sense the following magnetic fields: ± 1.5 mT, ± 5.0 mT, ± 10.0 mT, and ± 15.0 mT. The device also integrates a FLAG output that is active low and indicates when the field is above 90% and below 10% the full field range.

The CT220 is available in an industry standard 5-lead SOT23 package.

PACKAGE:



5-lead SOT23-5

Not to scale

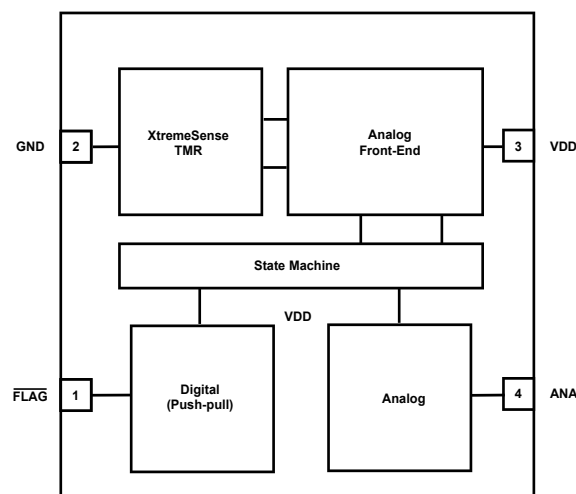

Figure 1: CT220 with Analog and FLAG Outputs in SOT23-5 Package Block Diagram

Table of Contents

Features and Benefits.....	1	Pinout Diagram and Terminal List.....	4
Description.....	1	Electrical Characteristics.....	5
Applications.....	1	Functional Description.....	15
Package.....	1	Calibration Guide.....	17
Functional Block Diagram.....	1	Applications Information.....	19
Selection Guide.....	2	Package Outline Drawing.....	22
Evaluation Board Ordering Information.....	2	Tape and Reel Pocket Drawings and Dimensions.....	23
Absolute Maximum Ratings.....	3	Package Information.....	24
Recommended Operating Conditions.....	3	Revision History.....	25

SELECTION GUIDE

Part Number	Magnetic Field Range (B_{ANA})	Sensitivity (mV/mT) $V_{DD} = 5 V$	Sensitivity (mV/mT) $V_{DD} = 3.3 V$	Total Error (%FS)	Operating Temperature Range (°C)
CT220BMV-IS5	±1.5 mT (±15 G)	1500	990	±5.0	-40 to 85
CT220BMV-HS5					-40 to 125
CT220FMV-IS5	±5.0 mT (±50 G)	450	297	±5.0	-40 to 85
CT220FMV-HS5					-40 to 125
CT220PMV-IS5	±10.0 mT (±100 G)	225	148.5	±5.0	-40 to 85
CT220PMV-HS5					-40 to 125
CT220RMV-IS5	±15.0 mT (±150 G)	150	99	±5.0	-40 to 85
CT220RMV-HS5					-40 to 125

EVALUATION BOARD ORDERING INFORMATION

Part Number	Current Range (mT)	Total Error (%FS)	Operating Temperature Range (°C)
EVB222-1.5A	±1.5	±5.0	-40 to 125
EVB222-5.0A	±5.0		
EVB222-10A	±10.0		
EVB222-15A	±15.0		

ABSOLUTE MAXIMUM RATINGS [1]

Characteristic	Symbol	Notes	Rating	Unit
Supply Voltage Strength	V_{DD}		-0.3 to 6.0	V
Push-Pull Output (Active LOW)	$V_{FLAG\#_PP}$		-0.3 to $V_{DD} + 0.3$ [2]	V
Input/Output Pins Maximum Voltage	$V_{I/O}$		-0.3 to $V_{DD} + 0.3$ [2]	V
Electrostatic Discharge Protection Level	ESD	Human Body Model (HBM) per JESD22-A114	±2.0	kV
Junction Temperature	T_J		-40 to 150	°C
Storage Temperature	T_{STG}		-65 to 150	°C
Lead Soldering Temperature	T_L	10 seconds	260	°C

[1] Stresses exceeding the absolute maximum ratings may damage the CT220 and may not function or be operable above the recommended operating conditions and stressing the parts to these levels is not recommended. In addition, extended exposure to stresses above the recommended operating conditions may affect device reliability. The absolute maximum ratings are stress ratings only.

[2] The lower of $V_{DD} + 0.3$ V or 6.0 V.

RECOMMENDED OPERATING CONDITIONS [1]

Characteristic	Symbol	Notes	Min.	Typ.	Max.	Unit
Supply Voltage Range	V_{DD}		2.7	5.0	5.5	V
Output Voltage Range	V_{OUT}		0	-	V_{DD}	V
Output Current	I_{OUT}		-	-	±10.0	µA
Operating Ambient Temperature	T_A	Industrial	-40	25	85	°C
		Extended Industrial	-40	25	125	°C

[1] The Recommended Operating Conditions table defines the conditions for actual operation of the CT220. Recommended operating conditions are specified to ensure optimal performance to the specifications. Allegro does not recommend exceeding them or designing to absolute maximum ratings.

PINOUT DIAGRAM AND TERMINAL LIST

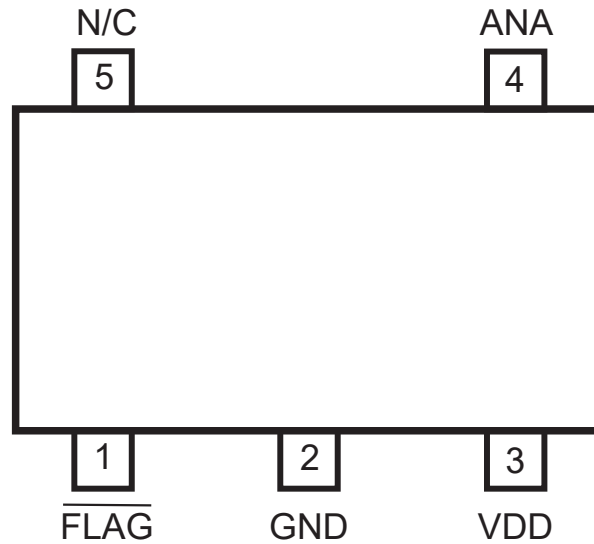

Figure 2: 5-Lead SOT23 Package, Top View

Terminal List

Number	Name	Function
1	$\overline{\text{FLAG}}$	Outputs an active LOW flag signal to indicate when the current is above 90% or below 10% of the full current range. It is a push-pull output.
2	GND	Ground
3	VDD	Supply Voltage
4	ANA	Analog output voltage that represents the measured current.
5	NC	No Connect

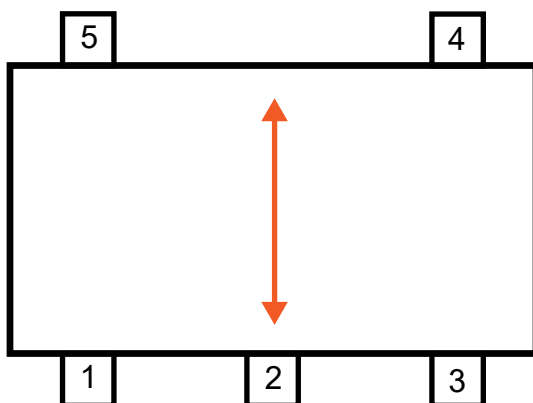

Figure 3: CT220 Axis of Sensitivity for Bipolar Magnetic Field with SOT23-5

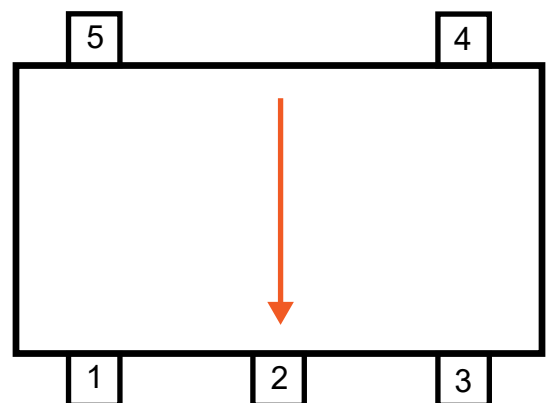

Figure 4: CT220 Recommended Axis of Sensitivity for Unipolar Magnetic Field with SOT23-5

ELECTRICAL CHARACTERISTICS: Valid for $V_{DD} = 2.7$ to 5.5 V, $C_{BYP} = 1.0$ μ F, and $T_A = -40^\circ$ C to 125° C, typical values are $V_{DD} = 5.0$ V and $T_A = 25^\circ$ C, unless otherwise specified

Characteristics	Symbol	Test Conditions	Min.	Typ.	Max.	Unit
Average Supply Current	$I_{DD(AVG)}$	$t \geq 10$ seconds	–	1.2	2.5	mA
Sampling Frequency	f_S		150	200	250	kHz
Idle Mode Time	t_{DLE}		4.0	5.0	6.7	μ s
ANALOG OUTPUT (ANA)						
Maximum Drive Capability	$I_{DRV(MAX)}$	$\Delta V_{OUT} \leq 150$ mV, $V_{DD} \geq 3.3$ V	–10	–	10	μ A
Analog Output Voltage Range	V_{ANA}		$0.05 \times V_{DD}$	–	$0.95 \times V_{DD}$	V
Voltage Output Quiescent	V_{OQ}		48.5	50.0	51.5	% V_{DD}
Rise Time [1]	t_{RISE}	$B_{ANA} = B_{ANA(MAX)}$, $t_{VANA_{90\%}} - t_{VANA_{10\%}}$	–	15.5	–	μ s
Propagation Delay [1]	t_{DELAY}	$B_{ANA} = B_{ANA(MAX)}$, $t_{BANA} - t_{VANA}$ @ 20% of output value	–	4.6	–	μ s
Response Time [1]	t_{RESP}	$B_{ANA} = B_{ANA(MAX)}$, $t_{BANA} - t_{VANA}$ @ 90% of output value	–	20.0	–	μ s
Input Referred Noise Density [1]	e_{ND}	$f_{BW} = 10$ Hz, $V_{DD} = 5.0$ V	–	0.15	–	μ T _{RMS} /√Hz
Output Capacitive Load	C_L		–	–	10	pF
FLAG PUSH-PULL OUTPUT (FLAG)						
FLAG Voltage LOW	$V_{FLAG\#_OL}$	Unipolar and bipolar fields	–	$0.9 \times V_{DD}$	–	V
		Bipolar field	–	$0.1 \times V_{DD}$	–	V
FLAG Voltage HIGH	$V_{FLAG\#_OH}$	Unipolar and bipolar fields	–	$0.86 \times V_{DD}$	–	V
		Bipolar field	–	$0.14 \times V_{DD}$	–	V
Current for FLAG	$I_{FLAG\#}$		–	± 2	–	mA
TIMINGS						
Power-On Time	t_{ON}	$V_{DD} \geq 2.7$ V	–	50	75	μ s
Active Mode Time	t_{ACTIVE}		–	2.5	–	μ s
PROTECTION						
Undervoltage Lockout	V_{UVLO}	Rising V_{DD}	–	2.3	2.5	V
		Falling V_{DD}	2.0	2.2	–	V
UVLO Hysteresis	V_{UV_HYS}		–	100	–	mV

[1] Guaranteed by design and characterization; not tested in production.

TYPICAL TIMING AND ELECTRICAL CHARACTERISTICS

$V_{DD} = 5.0\text{ V}$, $T_A = 25^\circ\text{C}$, and $C_{BYP} = 1.0\ \mu\text{F}$ (unless otherwise specified)

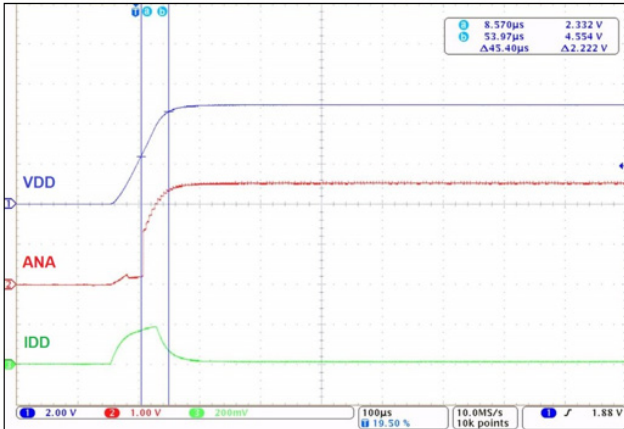

Figure 5: Power-On Time for CT220

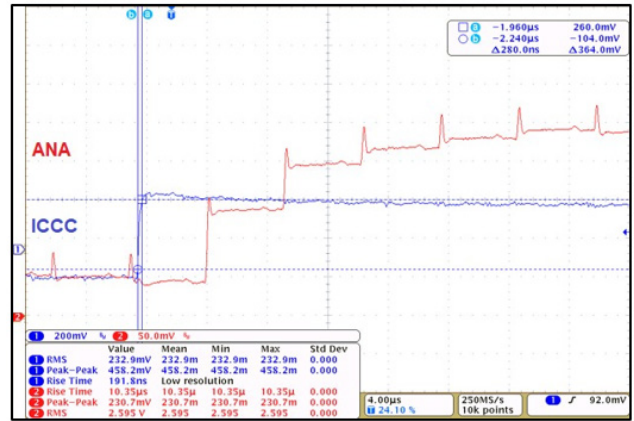

Figure 6: Rise Time for CT220

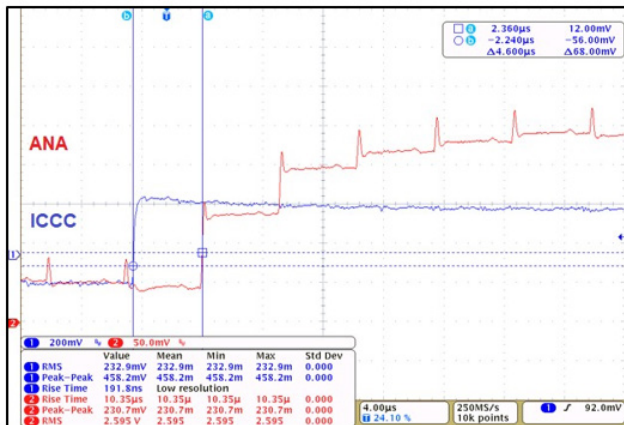

Figure 7: Propagation Delay Time for CT220

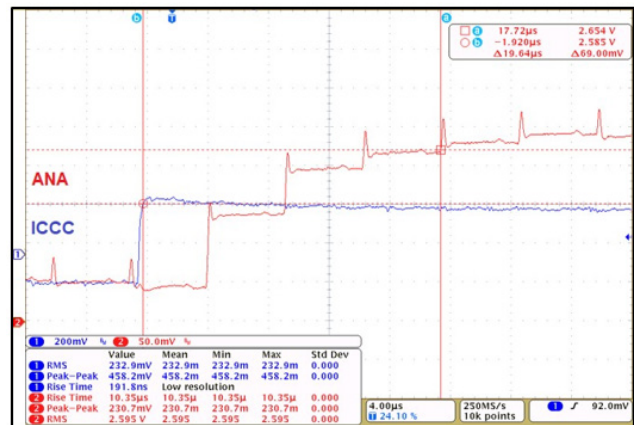

Figure 8: Response Time for CT220

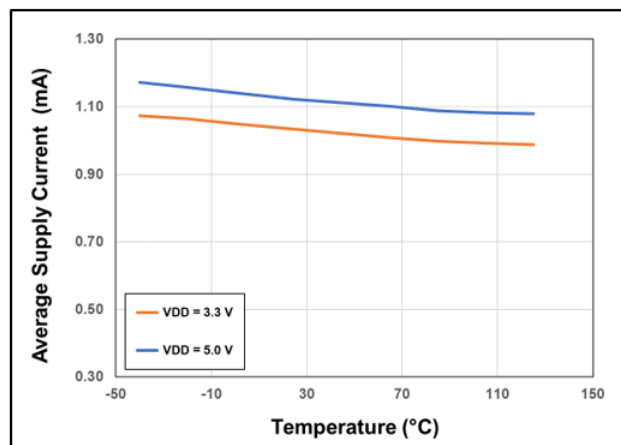

Figure 9: CT220 Average Supply Current vs. Temperature vs. Supply Voltage

CT220BMx (±1.5 mT) ELECTRICAL CHARACTERISTICS: Valid for $V_{DD} = 2.7$ to 5.5 V, $C_{BYP} = 1.0$ μ F, and $T_A = -40^\circ\text{C}$ to 125°C , typical values are $V_{DD} = 5.0$ V and $T_A = 25^\circ\text{C}$, unless otherwise specified

Characteristics	Symbol	Test Conditions	Min.	Typ.	Max.	Unit
ANALOG OUTPUT						
Gain	G	$V_{DD} = 5.0$ V, $T_A = 25^\circ\text{C}$	1475	1500	1525	mV/mT
		$V_{DD} = 3.3$ V, $T_A = 25^\circ\text{C}$	973.5	990	1006.5	mV/mT
Operating Magnetic Field	B_{ANA}		-1.5	-	+1.5	mT
RESOLUTION						
Resolution	RES	$I_{BUSBAR} = \pm 3.5$ A ^[1]	-	5.0	-	mA
TOTAL OUTPUT ERROR PERFORMANCE						
Total Output Error ^[2]	E_{TOT_BMV}	$T_A = 0^\circ\text{C}$ to 125°C	-	± 0.5	± 1.5	% FS
		$T_A = -40^\circ\text{C}$ to 125°C	-	± 0.5	± 5.0	% FS
TOTAL OUTPUT ERROR COMPONENTS						
Non-Linearity Error	e_{LIN}	$B_{ANA} = \pm 1.5$ mT, $T_A = -40^\circ\text{C}$ to $+125^\circ\text{C}$	-	± 0.15	-	% FS
Temperature Coefficient of Sensitivity ^[3]	TCS_{BMV}	$T_A = 0^\circ\text{C}$ to 125°C	-	-100	-	ppm/ $^\circ\text{C}$
		$T_A = -40^\circ\text{C}$ to 125°C	-	-200	-400	ppm/ $^\circ\text{C}$
Temperature Coefficient of Offset Voltage ^[3]	TCO	$T_A = -40^\circ\text{C}$ to 125°C , $V_{DD} = 5.0$ V	-	100	-	ppm/ $^\circ\text{C}$
NOISE						
Input Referred Noise ^[1]	e_N	$f_{BW} = 1$ Hz to 30 kHz, $V_{DD} = 5.0$ V	-	1.76	-	μT_{RMS}
			-	2.64	-	mV_{RMS}

^[1] Measurement result from EVB222 (top trace on PCB), CT220 evaluation board.

^[2] Reference section CT220 Calibration Guide.

^[3] Guaranteed by design and characterization; not tested in production.

TYPICAL ELECTRICAL AND MAGNETIC CHARACTERISTICS FOR CT220BMx

$V_{DD} = 5.0\text{ V}$, $T_A = 25^\circ\text{C}$, and $C_{BYP} = 1.0\ \mu\text{F}$ (unless otherwise specified)

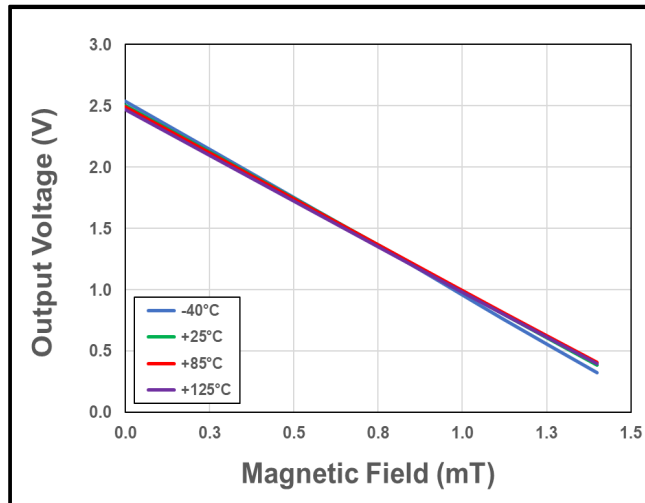

Figure 10: CT220BMx Output Voltage vs. Magnetic Field vs. Temperature

CT220FMx (±5.0 mT) ELECTRICAL CHARACTERISTICS: Valid for $V_{DD} = 2.7$ to 5.5 V, $C_{BYP} = 1.0$ μ F, and $T_A = -40^\circ\text{C}$ to 125°C , typical values are $V_{DD} = 5.0$ V and $T_A = 25^\circ\text{C}$, unless otherwise specified

Characteristics	Symbol	Test Conditions	Min.	Typ.	Max.	Unit
ANALOG OUTPUT						
Gain	G	$V_{DD} = 5.0$ V, $T_A = 25^\circ\text{C}$	435	450	465	mV/mT
		$V_{DD} = 3.3$ V, $T_A = 25^\circ\text{C}$	287.1	297	306.9	mV/mT
Operating Magnetic Field	B_{ANA}		-5	-	+5	A_{DC}
RESOLUTION						
Resolution	RES	$I_{TRACE} = \pm 3.5$ A [1]	-	5.0	-	mA
TOTAL OUTPUT ERROR PERFORMANCE						
Total Output Error [2]	E_{TOT_FMV}	$T_A = 0^\circ\text{C}$ to 125°C	-	± 0.5	± 1.5	% FS
		$T_A = -40^\circ\text{C}$ to 125°C	-	± 0.5	± 5.0	% FS
TOTAL OUTPUT ERROR COMPONENTS						
Non-Linearity Error	e_{LIN}	$B_{ANA} = \pm 5.0$ mT, $T_A = -40^\circ\text{C}$ to $+125^\circ\text{C}$	-	± 0.15	-	% FS
Temperature Coefficient of Sensitivity [3]	TCS_{FMV}	$T_A = 0^\circ\text{C}$ to 125°C	-	-100	-	ppm/ $^\circ\text{C}$
		$T_A = -40^\circ\text{C}$ to 125°C	-	-200	-400	ppm/ $^\circ\text{C}$
Temperature Coefficient of Offset Voltage [3]	TCO	$T_A = -40^\circ\text{C}$ to 125°C , $V_{DD} = 5.0$ V	-	100	-	ppm/ $^\circ\text{C}$
NOISE						
Input Referred Noise [1]	e_N	$f_{BW} = 1$ Hz to 30 kHz, $V_{DD} = 5.0$ V	-	1.85	-	μT_{RMS}
			-	0.83	-	mV $_{RMS}$

[1] Measurement result from EVB222 (top trace on PCB), CT220 evaluation board.

[2] Reference section CT220 Calibration Guide.

[3] Guaranteed by design and characterization; not tested in production.

TYPICAL ELECTRICAL AND MAGNETIC CHARACTERISTICS FOR CT220FMx

$V_{DD} = 5.0\text{ V}$, $T_A = 25^\circ\text{C}$, and $C_{BYP} = 1.0\ \mu\text{F}$ (unless otherwise specified)

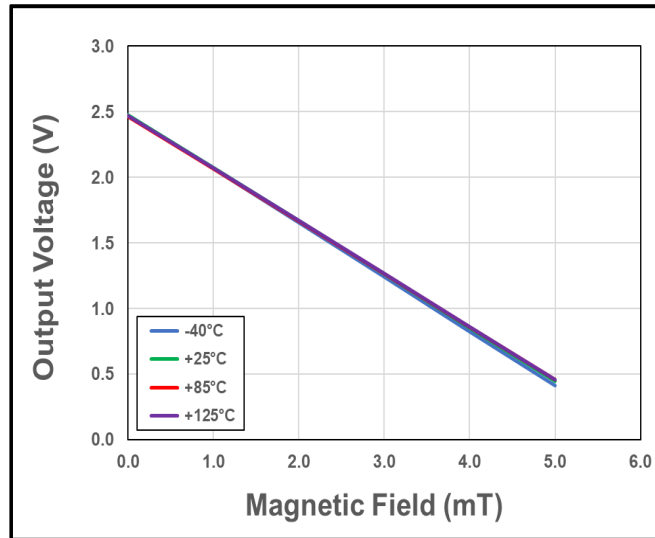

Figure 11: CT220FMx Output Voltage vs. Current vs. Temperature

CT220PMx (±10.0 mT) ELECTRICAL CHARACTERISTICS: Valid for $V_{DD} = 2.7$ to 5.5 V, $C_{BYP} = 1.0$ μ F, and $T_A = -40^\circ\text{C}$ to 125°C , typical values are $V_{DD} = 5.0$ V and $T_A = 25^\circ\text{C}$, unless otherwise specified

Characteristics	Symbol	Test Conditions	Min.	Typ.	Max.	Unit
ANALOG OUTPUT						
Gain	G	$V_{DD} = 5.0$ V, $T_A = 25^\circ\text{C}$	215	225	235	mV/mT
		$V_{DD} = 3.3$ V, $T_A = 25^\circ\text{C}$	141.9	148.5	155.1	mV/mT
Current Sensing Range	B_{ANA}		-10	-	+10	A_{DC}
RESOLUTION						
Resolution	RES	$I_{TRACE} = \pm 3.5 A_{PK}^{[1]}$	-	5	-	mA
TOTAL OUTPUT ERROR PERFORMANCE						
Total Output Error [2]	E_{TOT_PMV}	$T_A = 0^\circ\text{C}$ to 125°C	-	± 0.5	± 1.5	% FS
		$T_A = -40^\circ\text{C}$ to 125°C	-	± 0.5	± 5.0	% FS
TOTAL OUTPUT ERROR COMPONENTS						
Non-Linearity	e_{LIN}	$B_{ANA} = \pm 10.0$ mT, $T_A = -40^\circ\text{C}$ to 125°C	-	± 0.20	-	% FS
Temperature Coefficient of Sensitivity [3]	TCS_{PMV}	$T_A = 0^\circ\text{C}$ to 125°C	-	-100	-	ppm/ $^\circ\text{C}$
		$T_A = -40^\circ\text{C}$ to 125°C	-	-200	-400	ppm/ $^\circ\text{C}$
Temperature Coefficient of Offset Voltage [3]	TCO	$T_A = -40^\circ\text{C}$ to 125°C , $V_{DD} = 5.0$ V	-	100	-	ppm/ $^\circ\text{C}$
NOISE						
Input Referred Noise [3]	e_N	$f_{BW} = 1$ Hz to 30 kHz, $V_{DD} = 5.0$ V	-	2.37	-	μT_{RMS}
			-	0.53	-	mV $_{RMS}$

[1] Measurement result from EVB222 (top trace on PCB), CT220 evaluation board.

[2] Reference section CT220 Calibration Guide.

[3] Guaranteed by design and characterization; not tested in production.

TYPICAL ELECTRICAL CHARACTERISTICS FOR CT220PMx

$V_{DD} = 5.0\text{ V}$, $T_A = 25^\circ\text{C}$, and $C_{BYP} = 1.0\ \mu\text{F}$ (unless otherwise specified)

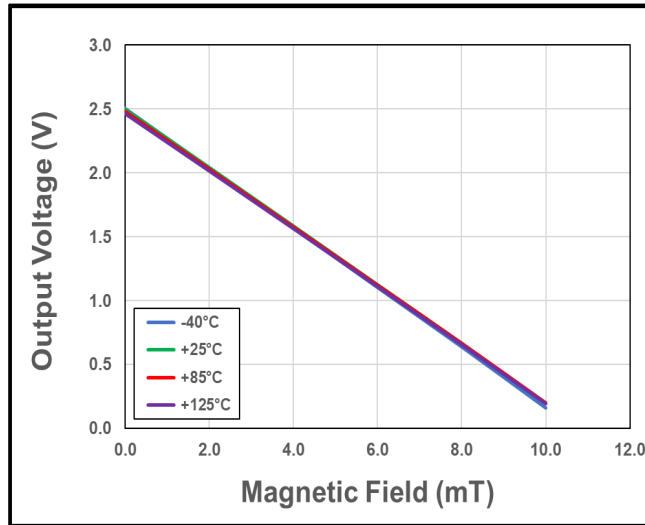

Figure 12: CT220PMx Output Voltage vs. Current vs. Temperature

CT220RMx (±15.0 mT) ELECTRICAL CHARACTERISTICS: Valid for $V_{DD} = 2.7$ to 5.5 V, $C_{BYP} = 1.0$ μ F, and $T_A = -40^\circ\text{C}$ to 125°C , typical values are $V_{DD} = 5.0$ V and $T_A = 25^\circ\text{C}$, unless otherwise specified

Characteristics	Symbol	Test Conditions	Min.	Typ.	Max.	Unit
ANALOG OUTPUT						
Gain	G	$V_{DD} = 5.0$ V, $T_A = 25^\circ\text{C}$	145	150	155	mV/mT
		$V_{DD} = 3.3$ V, $T_A = 25^\circ\text{C}$	95.7	99	102.3	mV/mT
Current Sensing Range	B_{ANA}		-15	-	+15	A_{DC}
RESOLUTION						
Resolution	RES	$I_{TRACE} = 3.5$ A ^[1]	-	5.0	-	mA
TOTAL OUTPUT ERROR PERFORMANCE						
Total Output Error ^[2]	E_{TOT_PMV}	$T_A = 0^\circ\text{C}$ to 125°C	-	± 0.5	± 1.5	% FS
		$T_A = -40^\circ\text{C}$ to 125°C	-	± 0.5	± 5.0	% FS
TOTAL OUTPUT ERROR COMPONENTS						
Non-Linearity	e_{LIN}	$B_{ANA} = \pm 15.0$ mT, $T_A = -40^\circ\text{C}$ to 125°C	-	± 0.30	-	% FS
Temperature Coefficient of Sensitivity ^[3]	TCS_{PMV}	$T_A = 0^\circ\text{C}$ to 125°C	-	-100	-	ppm/ $^\circ\text{C}$
		$T_A = -40^\circ\text{C}$ to 125°C	-	-200	-400	ppm/ $^\circ\text{C}$
Temperature Coefficient of Offset Voltage ^[3]	TCO	$T_A = -40^\circ\text{C}$ to 125°C , $V_{DD} = 5.0$ V	-	100	-	ppm/ $^\circ\text{C}$
NOISE						
Input Referred Noise ^[3]	e_N	$f_{BW} = 1$ Hz to 30 kHz, $V_{DD} = 5.0$ V	-	2.38	-	μT_{RMS}
			-	0.36	-	mV _{RMS}

^[1] Measurement result from EVB222 (top trace on PCB), CT220 evaluation board.

^[2] Reference section CT220 Calibration Guide.

^[3] Guaranteed by design and characterization; not tested in production.

TYPICAL ELECTRICAL CHARACTERISTICS FOR CT220RMx

$V_{DD} = 5.0\text{ V}$, $T_A = 25^\circ\text{C}$, and $C_{BYP} = 1.0\ \mu\text{F}$ (unless otherwise specified)

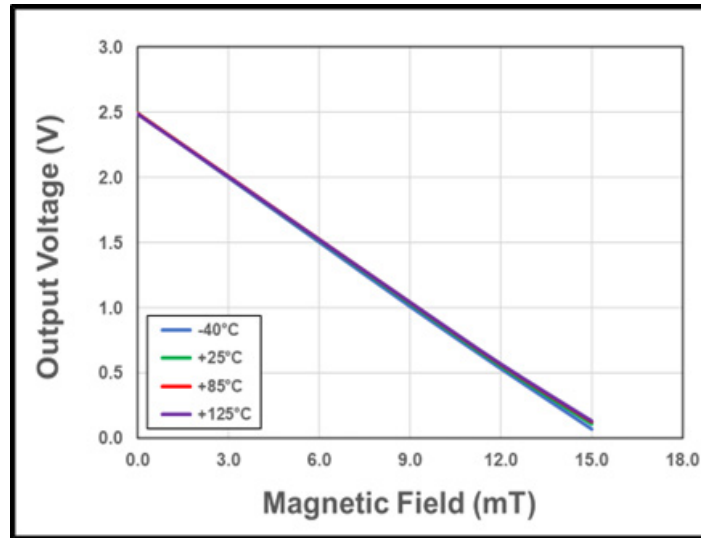

Figure 13: CT220RMx Output Voltage vs. Current vs. Temperature

FUNCTIONAL DESCRIPTION

Overview

The CT220 is a high-resolution and low-noise contact current sensor with isolation and a FLAG output that operates from 2.7 to 5.5 V assembled in an industry standard 5-lead SOT23 package. The chip measures the magnetic field of the current through the package and converts it to an analog signal that is equivalent to the current flowing through the printed circuit board (PCB) trace. The FLAG output indicates whether there is an overcurrent condition seen by CT220 during operation and will alert the host system.

Analog Output Measurement

The CT220 provides a continuous (sample and hold) linear analog output voltage which represents the measured magnetic field of the current. The output voltage range of ANA is 5.0% to 95.0% of V_{DD} which represents the current from the typical low-end values (-5.0 to -15.0 A_{PK}) to the maximum current values (+5.0 to +15.0 mT) respectively. The output sample frequency is 200 kHz. A resistor-capacitor (R-C) filter may be implemented on the ANA pin to further lower the noise. Figure 14 illustrates the output voltage range of the ANA pin as a function of the measured current for ±5.0 A (-1.5 to +15.0 mT) to the maximum field values (+1.5 to +15.0 mT) respectively. The output sampling frequency is 200 kHz. A resistor-capacitor (R-C) filter may be implemented on the ANA pin to further lower the noise. Figure 14 illustrates the output voltage range of the ANA pin as a function of the measured field of ±1.5 mT while Figure 15 shows the V_{ANA} vs. measured field of ±15.0 mT.

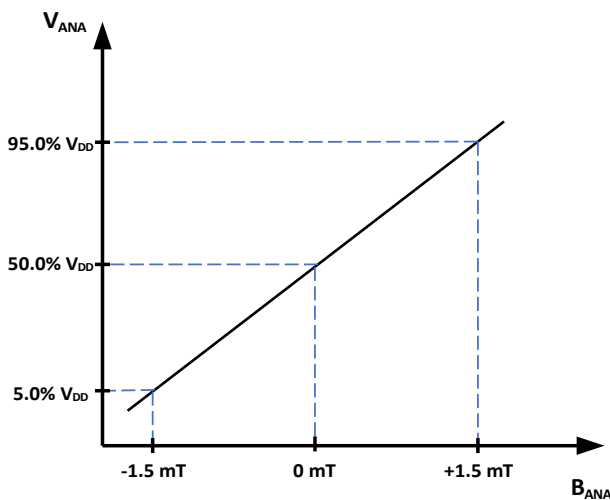

Figure 14: Linear Output Voltage Range vs. Measured Current for $G = 300$ mV/V/mT and current range of +1.5 mT.

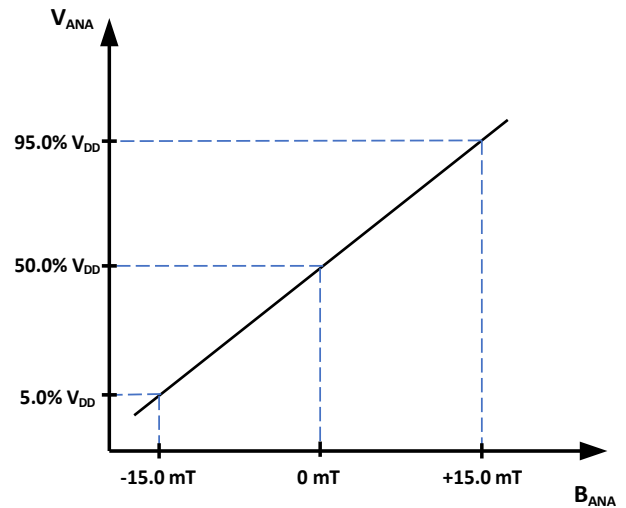

Figure 15: Linear Output Voltage Range vs. Measured Current for $G = 30$ mV/V/mT and current range of +15.0 mT.

Current Detection Flag

The Current Detection circuitry detects when the current measured through the current-carrying conductor is above 90% or below 10% of the full current range. As a result, it translates to greater than 90% of V_{DD} and 10% of V_{DD} on the ANA pin. This will generate a flag signal via the FLAG pin to the host system microcontroller as an active LOW signal. Once V_{ANA} falls below 86% or rises above 14% of V_{DD} , then the FLAG signal will go high.

Rise Time (t_{RISE})

The CT220 rise time, t_{RISE} , is the time interval when full-scale output voltage of 10% and 90% is reached. The t_{RISE} of the CT220 is 15.5 μ s.

Propagation Delay (t_{DELAY})

The propagation delay, t_{DELAY} , is the time measured between I_{CCC} reaching 20% of its final value and the CT220 attaining 20% of its full-scale output voltage. Its propagation delay is 4.6 μ s.

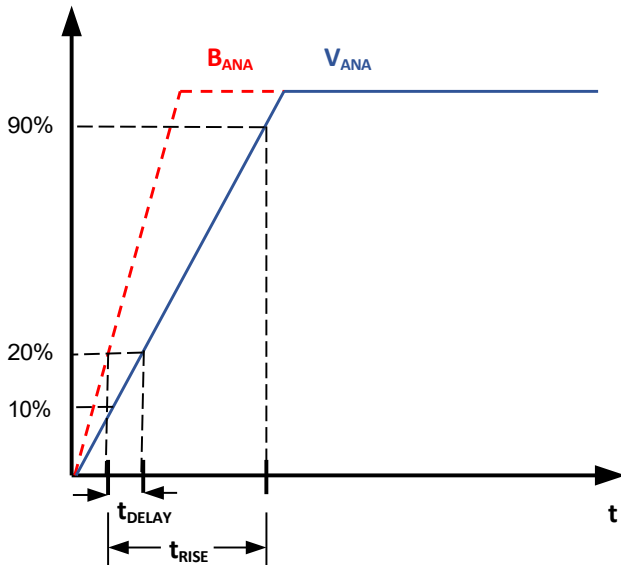

Figure 16: CT220 Propagation Delay and Rise Time Curve

Response Time (t_{RESP})

The response time, t_{RESP} , is the difference in time from when I_{CCC} reaches 90% of its final value and V_{ANA} attains 90% of its final value. The CT220 response time is typically 20.0 μ s.

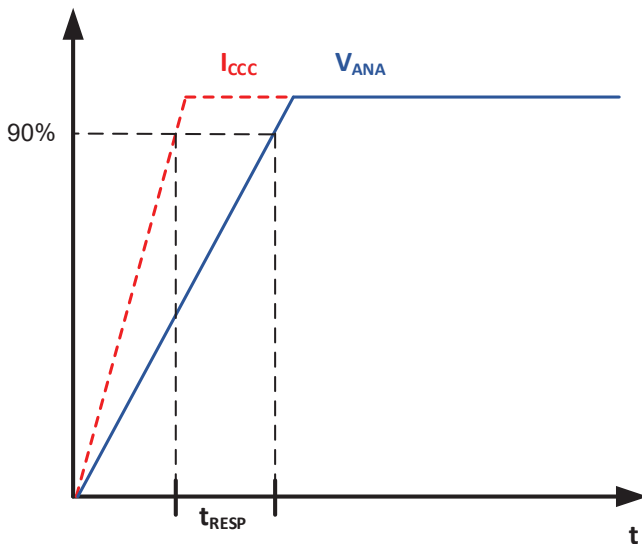

Figure 17: CT220 Response Time Curve

Power-On Time (t_{ON})

The Power-On Time (t_{ON}) of 50 μ s is the amount of time required by the CT220 to start up, power-on, and acquire the first sample. The chip is fully powered up and operational from the moment the supply voltage passes the rising UVLO point (2.3 V). This time includes ramp-up time and settling time (within 10% of steady-state voltage when current is flowing through the package) after the power supply has reached the minimum V_{DD} .

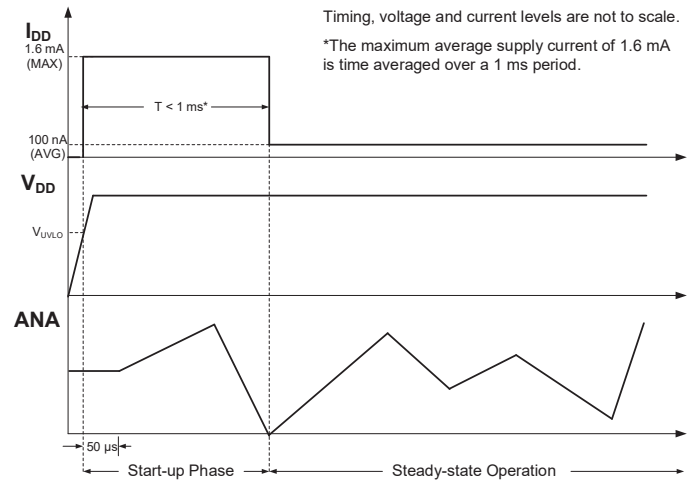

Figure 18: CT220 Power-On Timing Diagram

Undervoltage Lockout (UVLO)

The Undervoltage Lockout protection circuitry of the CT220 is activated when the supply voltage (V_{DD}) falls below 2.1 V. The CT220 remains in a low quiescent state and the ANA output is not valid until V_{DD} rises above the UVLO threshold (2.3 V).

Low Resolution and Low Noise

For the unipolar field, the resolution is TBD μ T (5 mA) while the input referred noise in TBD μ T_{RMS} (7 mA_{RMS}) however there is no contradiction in the CT220's capability to sense this level of current because the 5 mA was measured with a digital multi-meter (DMM) with limited bandwidth whereas the noise is over a wider bandwidth (up to 30 kHz).

CALIBRATION GUIDE

Introduction

All current sensors, no matter how expensive they are, or what materials they use, or even if they were factory-calibrated, are susceptible to deviations from their Ideal Transfer Line.

To extract the absolute best performance from any current sensing system, calibration is required.

Ideal Transfer Line

Ideally, the sensor output follows a straight line, has a fixed slope, and crosses a fix offset point. This allows the user to apply a straightforward linear equation to extract the physical value being measured. In the case of a current sensor:

$$Current = \frac{Voltage - b}{a}$$

where a is the slope and b is the offset of the ideal curve. In a perfect sensor, both a and b coefficients can be simply looked up on the datasheet.

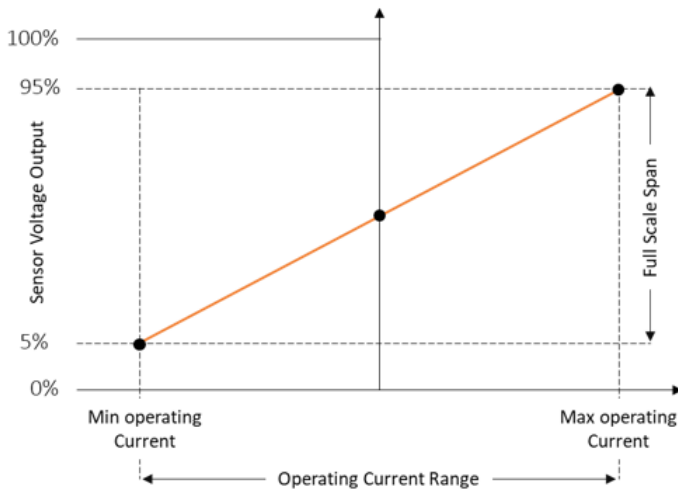

Figure 19: Ideal Transfer Line

Any deviations from this Ideal Line are considered sensor errors—more specifically, Accuracy Errors as they related in the case of Allegro sensors to Gain and Offset errors.

Offset Error

Based on the Ideal Transfer Line, when no current is applied, the voltage output of the sensor should be equal to 50% of V_{DD}.

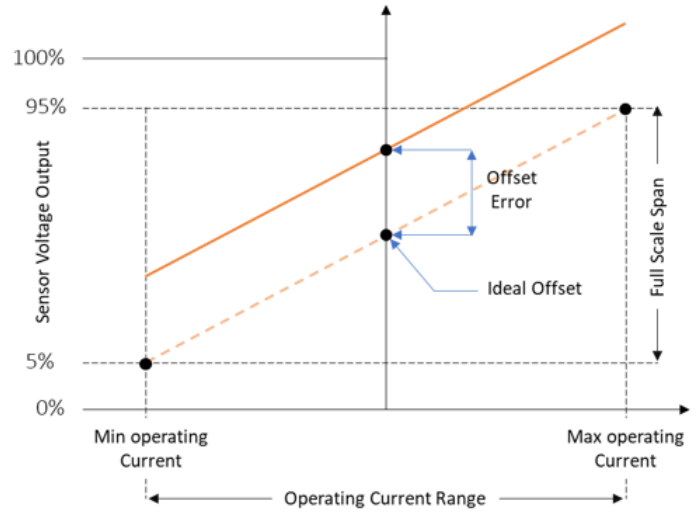

Figure 20: Exaggerated Offset Error

Gain Error

The Ideal Transfer Line shows a line that reaches 95% of V_{DD} at the maximum operating current and 5% of V_{DD} at the minimum.

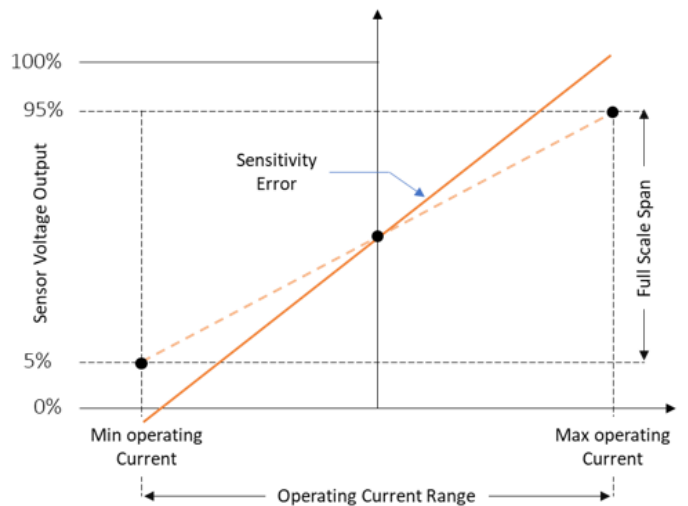

Figure 21: Exaggerated Gain Error

Calibration

Different methods can be applied for offset and/or gain correction. The complexity of these methods lead to different calibration results. The higher the complexity the better the error correction.

Simple Offset Correction

Offset calibration is achieved simply by storing the voltage output of the sensor at zero flowing current.

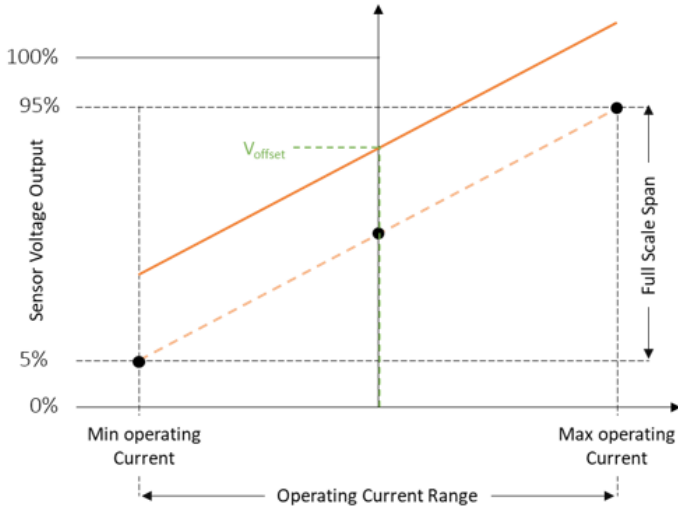

Figure 22: Simple Offset Calibration

This stored value V_{OFFSET} becomes the coefficient b in the linear transfer function:

$$Current = \frac{Voltage - b}{a}$$

Simple Gain Correction

Basic Gain calibration can be achieved by applying a known current value (A_1) and measuring the sensor output voltage value (V_1).

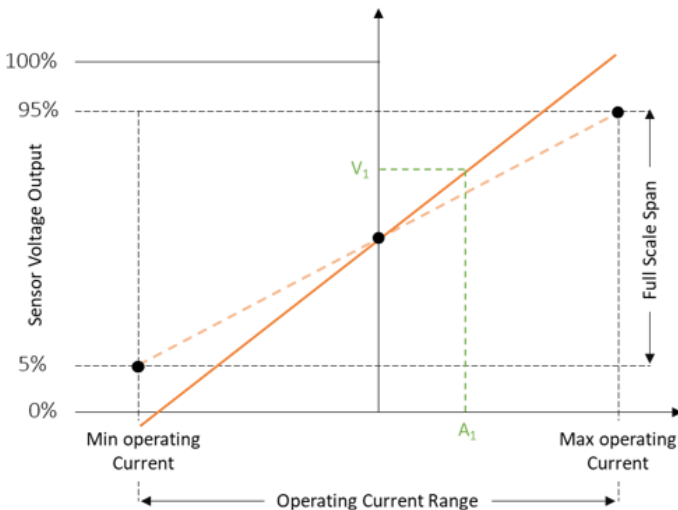

Figure 23: Simple Gain Calibration

The following equation is used to calculate the slope coefficient a :

$$a = \frac{V_1 - V_{OFFSET}}{A_1}$$

Recommended Offset and Gain Correction

For bidirectional current applications, the steps below are recommended for users trying to perform the best error correction of gain and offset.

1. Apply a known current value (A_1) and measure voltage output (V_1)
2. Apply a second current value (A_2) and measure the voltage output (V_2)
3. Calculate the slope using the following equation

It is recommended that the applied currents A_1 and A_2 are the absolute maximum and minimum operating current the sensor will see during its normal operations.

Also, $A_1 = -A_2$ for bidirectional current sensing.

$$a = \frac{V_1 - V_2}{A_1 - A_2} \quad b = \frac{V_1 + V_2}{2}$$

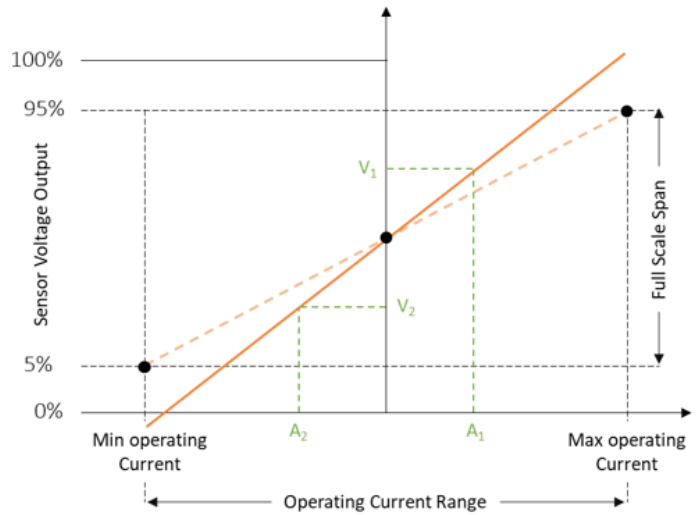

Figure 24: Gain Calibration

Both calculated coefficients a and b are then used to calculate the current:

$$Current = \frac{Voltage - b}{a}$$

APPLICATIONS INFORMATION

Overview

The CT220 is an ideal solution to measure current non-intrusively as it provides highly accurate current values by measuring the magnetic field that is generated by the flow of current through a PCB trace or busbar. Because this implementation is contactless, the isolation is infinite so there is no need to use isolation amplifiers. The CT220 only needs a 1.0 μF bypass capacitor connected to the VDD pin. A resistor-capacitor filter on the ANA pin is recommended to minimize the output noise as shown in Figure 24. Refer to Table 2 for recommended cutoff frequencies.

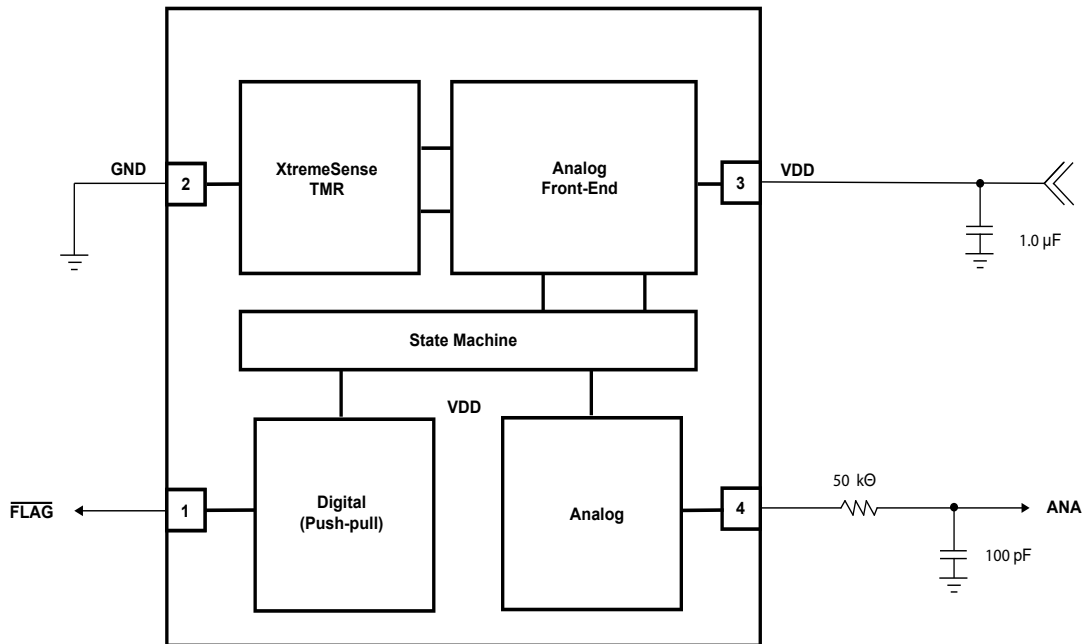

Figure 25: CT220 with Analog and FLAG Outputs Application Block Diagram

Table 1: Recommended External Components for CT220

Component	Description	Vendor and Part Number	Parameter	Min.	Typ.	Max.	Unit
C_{BYP}	1.0 μF , X5R or Better	Murata GRM155C81A105KA12	C	–	1.0	–	μF
R_{FILTER}	50 k Ω , $\pm 5\%$	Various	R	–	50	–	k Ω
C_{FILTER}	100 pF, X5R or Better	Various	C	–	10	–	pF

Table 2: Recommended Cutoff Frequencies for CT220 and its Resistor-Capacitor Values

Cutoff Frequency (kHz)	Resistor Value (k Ω)	Capacitor Value (pF)
1	105	1,500
10	105	150
30	50	100

Unipolar Current Measurement

The CT220 must be placed in the correct orientation on the PCB to measure unipolar current in either a PCB trace or a busbar above or beneath the device. The axis of sensitivity of the CT220 for unipolar magnetic fields, i.e. unipolar current is along the vertical direction of the surface of the package pointing towards pin 1; see Figure 4 for reference.

For unipolar measurements of either a top or bottom PCB trace and a busbar below the CT220, the flow of unipolar current is from left to right as shown in Figure 25. This direction is derived using Ampere’s right-hand rule where the thumb represents the direction of the current and the curl of the fingers is the direction of the magnetic field. In the case of an application using a busbar that is placed above the CT220 the current flows right to left, see Figure 26.

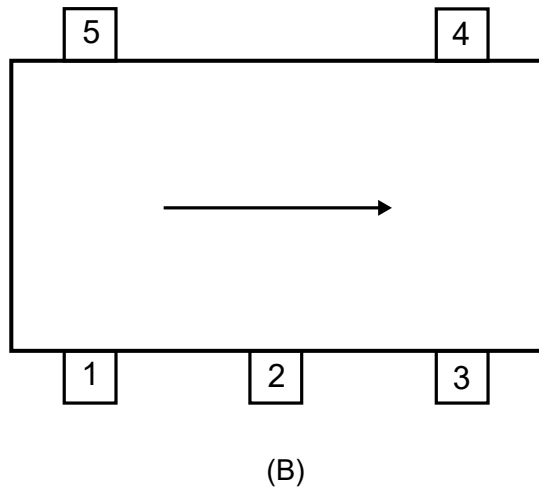
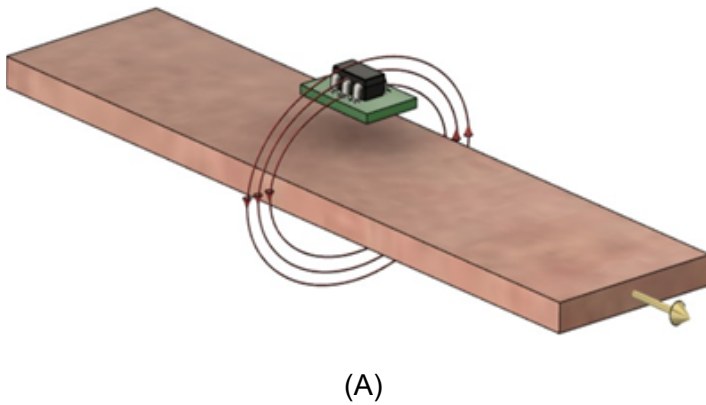

Figure 26: CT220 measuring unipolar current in a busbar below it where (A) indicates the unipolar current and magnetic field directions, and (B) is the direction of unipolar current flow that the CT220 must be oriented.

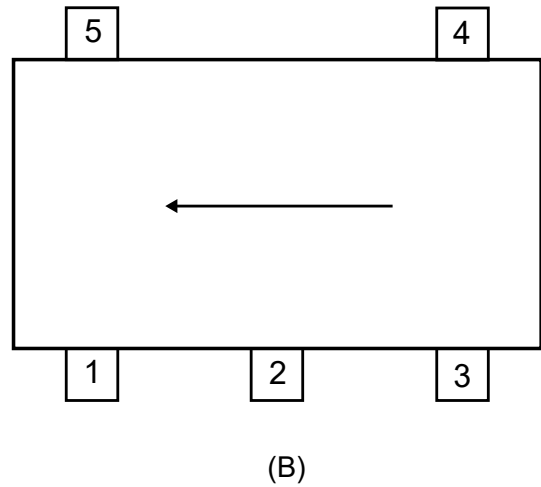
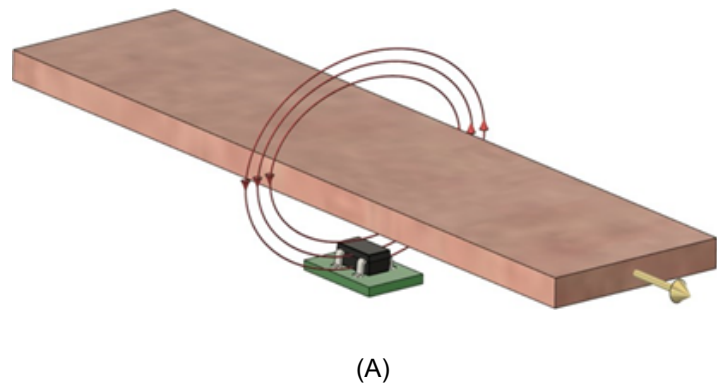

Figure 27: Measuring unipolar current of a busbar placed above the CT220 where (A) shows the direction of the unipolar current and magnetic field, and (B) is the direction of unipolar current flow with respect to the CT220 package.

TMR Sensor Location

The x, y dimensions of the CT220 XtremeSense TMR sensor location in a 5-lead SOT23 are shown in Figure 27, while Figure 28 illustrates the z dimension. All dimensions in the figures below are nominal and in millimeters (mm).

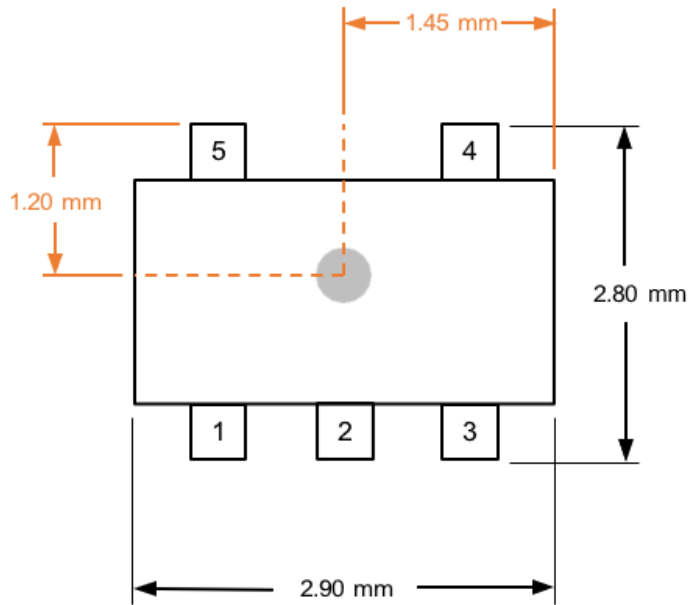

Figure 28: XtremeSense TMR Sensor Location in X and Y Dimensions for CT220 in SOT23-5 Package

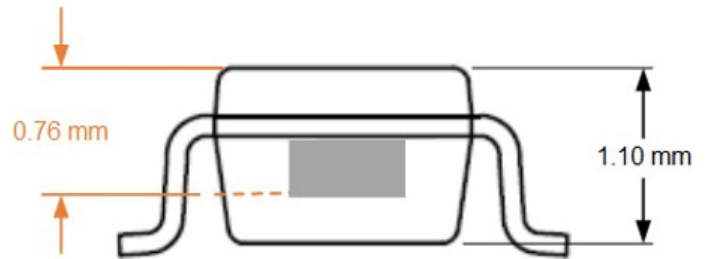
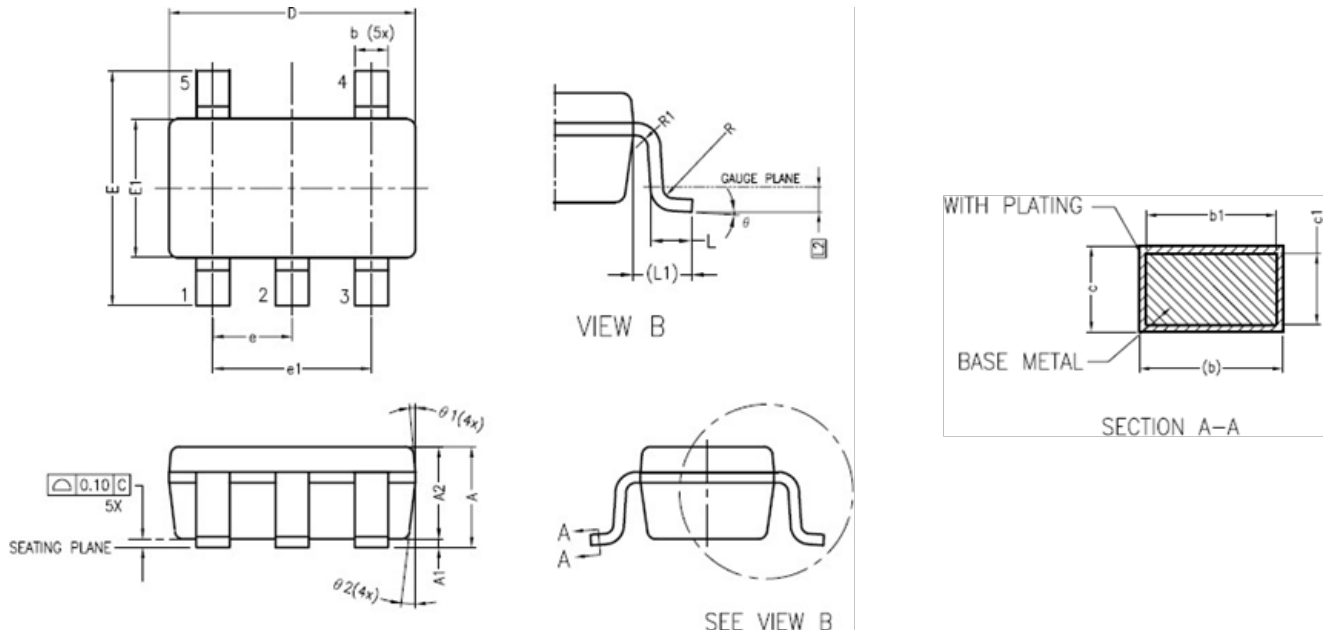

Figure 29: XtremeSense TMR Sensor Location in Z Dimension for CT220 in SOT23-5 Package

PACKAGE OUTLINE DRAWING



NOTES:

1. Dimension e represents the basic terminal pitch. It specifies the geometric position of the terminal axis.
2. Dimension b applies to the metalized terminal pads.
3. Dimension A includes package warpage.
4. Exposed metalized pads are Cu (Copper) pads with OSP surface.
5. All dimensions are in millimeters (mm).

Figure 30: SOT23-5 Package Drawing and Dimensions

Table 3: CT220 SOT23-5 Package Dimensions

Symbol	Dimensions in Millimeters (mm)		
	Min.	Typ.	Max.
A	1.05	1.20	1.35
A1	0.00	0.10	0.15
A2	1.00	–	1.20
b	0.40	–	0.50
b1	0.40	0.40	0.45
c	0.08	–	0.22
c1	0.08	0.13	0.20
D	2.80	2.90	3.00
E	2.60	2.80	3.00
E1	1.50	1.60	1.70

Symbol	Dimensions in Millimeters (mm)		
	Min.	Typ.	Max.
e	0.95 BSC		
e1	1.90 BSC		
L	0.35	0.43	0.60
L1	0.60 REF		
L2	0.25 BSC		
R	0.10	–	–
R1	0.10	–	0.25
θ	0°	4°	8°
$\theta 1$	5°	6°	15°
$\theta 2$	5°	8°	15°

TAPE AND REEL POCKET DRAWING AND DIMENSIONS

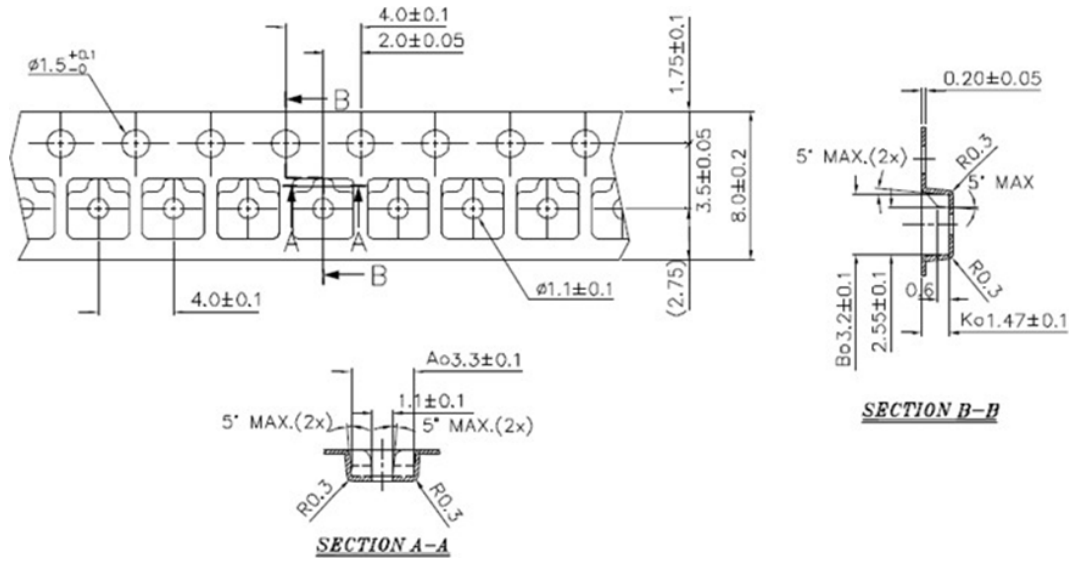

NOTES:

1. Material: Conductive Polystyrene
2. Dimensions in mm.
3. 10 sprocket hole pitch cumulative tolerance ± 0.20 mm.
4. Camber bot to exceed 1 mm in 100 mm.
5. Pocket position relative to sprocket hole measured as true position of pocket and not pocket hole.
6. (S.R. 0/sq) means surface electric resistivity of the carrier tape.

Figure 31: Tape and Pocket Drawing for SOT23 Package

PACKAGE INFORMATION

Table 4: CT220 Package Information

Part Number	Package Type	# of Leads	Package Quantity	Lead Finish	Eco Plan [1]	MSL Rating [2]	Operating Temperature [3]	Device Marking [4]
CT220BMV-IS5	SOT23	5	3000	Sn	Green & RoHS	1	-40°C to 85°C	ACY WWS
CT220BMV-HS5	SOT23	5	3000	Sn	Green & RoHS	1	-40°C to 125°C	ACY WWS
CT220FMV-IS5	SOT23	5	3000	Sn	Green & RoHS	1	-40°C to 85°C	AGY WWS
CT220FMV-HS5	SOT23	5	3000	Sn	Green & RoHS	1	-40°C to 125°C	AGY WWS
CT220PMV-IS5	SOT23	5	3000	Sn	Green & RoHS	1	-40°C to 85°C	AQY WWS
CT220PMV-HS5	SOT23	5	3000	Sn	Green & RoHS	1	-40°C to 125°C	AQY WWS
CT220RMV-IS5	SOT23	5	3000	Sn	Green & RoHS	1	-40°C to 85°C	ASY WWS
CT220RMV-HS5	SOT23	5	3000	Sn	Green & RoHS	1	-40°C to 125°C	ASY WWS

[1] RoHS is defined as semiconductor products that are compliant to the current EU RoHS requirements. It also will meet the requirement that RoHS substances do not exceed 0.1% by weight in homogeneous materials. Green is defined as the content of chlorine (Cl), bromine (Br), and antimony trioxide based flame retardants satisfy JS709B low halogen requirements of $\leq 1,000$ ppm.

[2] MSL Rating = Moisture Sensitivity Level Rating as defined by JEDEC standard classifications.

[3] Package will withstand ambient temperature range of -40°C to 150°C and storage temperature range of -65°C to 160°C.

[4] Device Marking for SOT23 is defined as XZ YWWS where XZ = part number and Y = Year, WW = work week, and S = sequential number.

Revision History

Number	Date	Description
1	December 15, 2023	Document rebranded and minor editorial updates.
2	March 12, 2024	Updated Selection Guide (page 2), Total Output Error Performance (pages 7, 9, 11, and 13) and Package Information (page 24).
3	May 21, 2024	Corrected Terminal List table (page 4) and minor editorial updates.

Copyright 2024, Allegro MicroSystems.

Allegro MicroSystems reserves the right to make, from time to time, such departures from the detail specifications as may be required to permit improvements in the performance, reliability, or manufacturability of its products. Before placing an order, the user is cautioned to verify that the information being relied upon is current.

Allegro's products are not to be used in any devices or systems, including but not limited to life support devices or systems, in which a failure of Allegro's product can reasonably be expected to cause bodily harm.

The information included herein is believed to be accurate and reliable. However, Allegro MicroSystems assumes no responsibility for its use; nor for any infringement of patents or other rights of third parties which may result from its use.

Copies of this document are considered uncontrolled documents.

For the latest version of this document, visit our website:

www.allegromicro.com