

## ZB5AA48C0

Head for illuminated push button, Harmony XB5, grey bezel, red flush, 22mm, universal LED, for insertion of legend



### Main

Range of Product	Harmony XB5
Product or Component Type	Head for illuminated push-button
Device short name	ZB5
Product Compatibility	Universal LED
Bezel material	Plastic colour plated grey
Mounting diameter	0.87 in (22 mm)
Sale per indivisible quantity	1
Head type	Standard
Shape of signaling unit head	Round
Type of operator	Spring return
Operator profile	Red flush, unmarked
Operator additional information	For insertion of legend

### Complementary

CAD overall width	1.14 in (29 mm)
CAD overall height	1.14 in (29 mm)
CAD overall depth	1.18 in (30 mm)
Net Weight	0.04 lb(US) (0.018 kg)
Resistance to high pressure washer	1015.26 psi (7000000 Pa) 131 °F (55 °C) 0.1 m
Mechanical durability	10000000 cycles
Main group	Illum push-button
Group of product	Flush push with inser of legend
Station name	XALD 1...5 cut-outs XALK 2...5 cut-outs
Cap/operator or lens colour	Red
Marking	Unmarked
Electrical composition code	M1 6 single front mounting integral LED M2 6 single and double front mounting integral LED M6 2 single front mounting integral LED and transformer M10 2 single front mounting integral LED MF1 2 single front mounting integral LED MR1 2 single rear mounting integral LED C3 6 single front mounting C4 6 single and double front mounting C14 2 single front mounting SF2 2 single front mounting SR2 2 single rear mounting
Device presentation	Basic element

### Environment

Protective treatment	TC
Ambient Air Temperature for Storage	-40...158 °F (-40...70 °C)
Ambient air temperature for operation	-40...158 °F (-40...70 °C)
Overvoltage category	Class II IEC 60536
IP degree of protection	IP66 IEC 60529 IP67

NEMA degree of protection	NEMA 13 NEMA 4X
IK degree of protection	IK03 conforming to EN 50102
Standards	EN/IEC 60947-5-1 UL 508 CSA C22.2 No 14 GB 14048.5 EN/IEC 60947-1 JIS C8201-5-1 EN/IEC 60947-5-4 JIS C8201-1
Product Certifications	DNV[RETURN]BV[RETURN]GL[RETURN]CSA[RETURN]UL Listed[RETURN]LR0S (Lloyds register of shipping)
Vibration resistance	5 gn 2...500 Hz)IEC 60068-2-6
Shock resistance	30 gn 18 ms) half sine wave acceleration IEC 60068-2-27 50 gn 11 ms) half sine wave acceleration IEC 60068-2-27

### Ordering and shipping details

Category	US10CS222467
Discount Schedule	0CS2
GTIN	3606489762506
Returnability	No
Country of origin	FR

### Packing Units

Unit Type of Package 1	PCE
Number of Units in Package 1	1
Package 1 Height	3.39 in (8.6 cm)
Package 1 Width	1.30 in (3.3 cm)
Package 1 Length	2.05 in (5.2 cm)
Package 1 Weight	0.71 oz (20.0 g)

### Offer Sustainability

California proposition 65	WARNING: This product can expose you to chemicals including: Di-isodecyl phthalate (DIDP), which is known to the State of California to cause birth defects or other reproductive harm. For more information go to <a href="http://www.P65Warnings.ca.gov">www.P65Warnings.ca.gov</a>
REACH Regulation	 <a href="#">REACH Declaration</a>
REACH free of SVHC	Yes
EU RoHS Directive	Pro-active compliance (Product out of EU RoHS legal scope)
Mercury free	Yes
China RoHS Regulation	 <a href="#">China RoHS Declaration</a>
RoHS exemption information	 <a href="#">Yes</a>

---

Dimensions

---

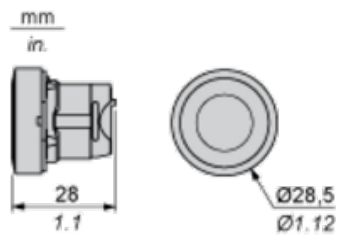

Panel Cut-out for Pushbuttons, Switches and Pilot Lights (Finished Holes, Ready for Installation)

Connection by Screw Clamp Terminals or Plug-in Connectors or on Printed Circuit Board



- (1) Diameter on finished panel or support
- (2) For selector switches and Emergency stop buttons, use of an anti-rotation plate type ZB5AZ902 is recommended.
- (3)  $\varnothing 22.5$  mm recommended ( $\varnothing 22.3_0^{+0.4}$ ) /  $\varnothing 0.89$  in. recommended ( $\varnothing 0.88$  in.  $_0^{+0.016}$ )

Connections	a in mm	a in in.	b in mm	b in in.
By screw clamp terminals or plug-in connector	40	1.57	30	1.18
By Faston connectors	45	1.77	32	1.26
On printed circuit board	30	1.18	30	1.18

Detail of Lug Recess

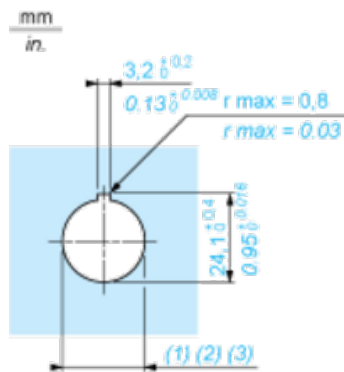

- (1) Diameter on finished panel or support
- (2) For selector switches and Emergency stop buttons, use of an anti-rotation plate type ZB5AZ902 is recommended.
- (3)  $\varnothing 22.5$  mm recommended ( $\varnothing 22.3_0^{+0.4}$ ) /  $\varnothing 0.89$  in. recommended ( $\varnothing 0.88$  in.  $_0^{+0.016}$ )

Pushbuttons, Switches and Pilot Lights for Printed Circuit Board Connection

Panel Cut-outs (Viewed from Installer's Side)



A: 30 mm min. / 1.18 in. min.

B: 40 mm min. / 1.57 in. min.

Printed Circuit Board Cut-outs (Viewed from Electrical Block Side)

Dimensions in mm



A: 30 mm min.

B: 40 mm min.

Dimensions in in.

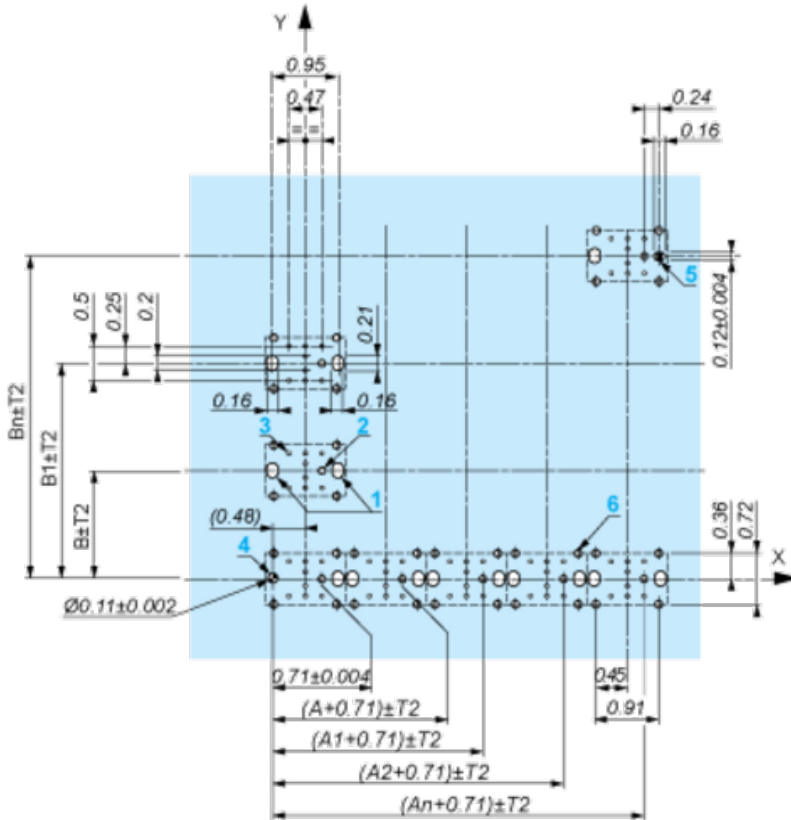

A: 1.18 in. min.  
 B: 1.57 in. min.

### General Tolerances of the Panel and Printed Circuit Board

The cumulative tolerance must not exceed 0.3 mm / 0.012 in.:  $T1 + T2 = 0.3 \text{ mm max.}$

### Installation Precautions

- Minimum thickness of circuit board: 1.6 mm / 0.06 in.
- Cut-out diameter: 22.4 mm  $\pm$  0.1 / 0.88 in.  $\pm$  0.004
- Orientation of body/fixing collar ZB5AZ009:  $\pm 2^\circ 30'$  (excluding cut-outs marked a and b).
- Tightening torque of screws ZBZ006: 0.6 N.m (5.3 lbf.in) max.
- Allow for one ZB5AZ079 fixing collar/pillar and its fixing screws:
  - every 90 mm / 3.54 in. horizontally (X), and 120 mm / 4.72 in. vertically (Y).
  - with each selector switch head (ZB5AD•, ZB5AJ•, ZB5AG•).

The fixing centers marked a and b are diagonally opposed and must align with those marked 4 and 5.



- (1) Head ZB5AD•  
 (2) Panel  
 (2) Nut

#### (4) Printed circuit board

##### Mounting of Adapter (Socket) ZBZ01•

- 1 2 elongated holes for ZBZ006 screw access
- 2 1 hole  $\varnothing$  2.4 mm  $\pm$  0.05 / 0.09 in.  $\pm$  0.002 for centring adapter ZBZ01•
- 3 8  $\times$   $\varnothing$  1.2 mm / 0.05 in. holes
- 4 1 hole  $\varnothing$  2.9 mm  $\pm$  0.05 / 0.11 in.  $\pm$  0.002, for aligning the printed circuit board (with cut-out marked a)
- 5 1 elongated hole for aligning the printed circuit board (with cut-out marked b)
- 6 4 holes  $\varnothing$  2.4 mm / 0.09 in. for clipping in adapter ZBZ01•

Dimensions An + 18.1 relate to the  $\varnothing$  2.4 mm  $\pm$  0.05 / 0.09 in.  $\pm$  0.002 holes for centring adapter ZBZ01•.

---

Electrical Composition Corresponding to Code C3

---

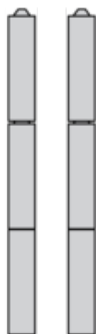

---

Electrical Composition Corresponding to Code C4

---

---

Electrical Composition Corresponding to Codes C14, SF2 and SR2

---

---

Electrical Composition Corresponding to Codes M1 and M7

---

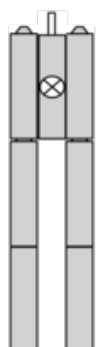

---

Electrical Composition Corresponding to Codes M2 and M8

---



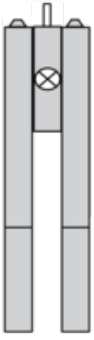

### Electrical Composition Corresponding to Codes M6 and P2

---

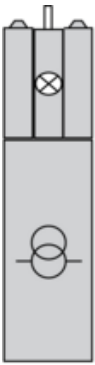

### Electrical Composition Corresponding to Codes M5, M10, MF1, MR1 and MF2

---

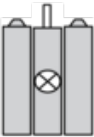

### Legend

---

Single contact

Double contact

Light block

Possible location

