

APPROVED: _____
 DATE: _____ TITLE: _____

Rev	AWO #	Description	Date	Appr
-		RELEASED	9/13/21	
A		ADDED PAGE 2	10/12/21	LH/RC
B		ADDED PACKING	10/15/21	LH/RC
C		UPDATED DRAWING	6/8/22	JJ/JL
D		UPDATED SPEC.	11/7/22	LH/RC

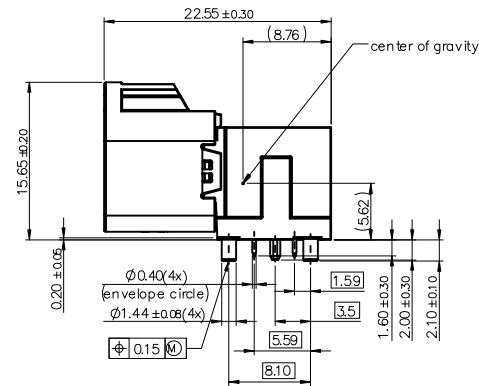
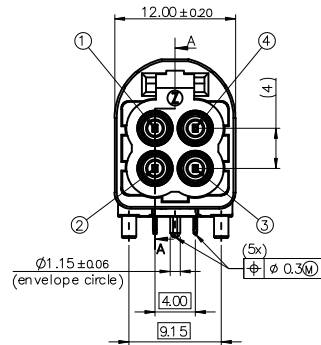
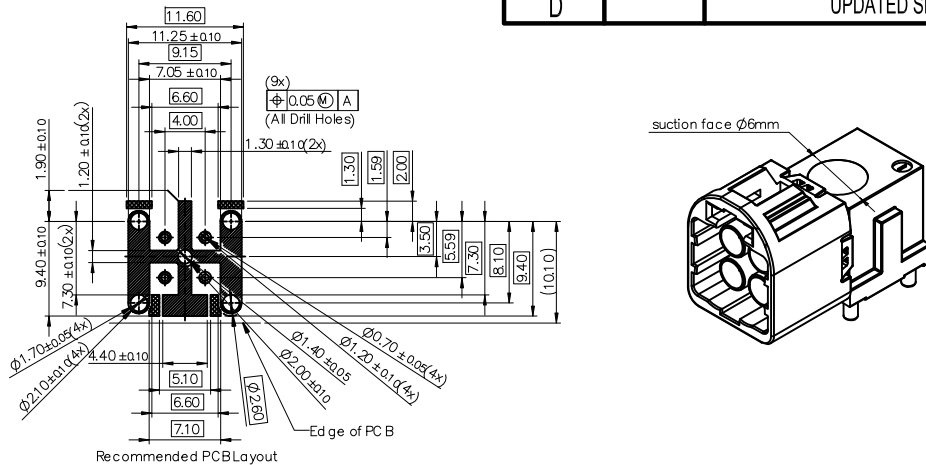

SPECIFICATIONS:

Material:
 Insulator: Hi-Temp Thermoplastic, rated UL 94V-0
 Center Contacts: Brass
 Outer Contacts (Interface): Stainless steel, Matte Tin plated
 Shell: Zamak, Tin Plated
 Outer Contact Sheet: Brass, Matte Tin plated
 Contact Plating:
 Contact area: 6u" Gold Plated
 Solder tails area: 80-160u" Matte Tin Plated
 Underplate: 80-160u" Nickel underplate overall

Electrical:
 Working voltage: ≤ 60 VDC
 Power Current : ≤ 1A DC
 Impedance: 50Ω
 Frequency: DC to 9 GHz
 Center Contact Resistance: ≤ 15m Ω
 Outer Contact Resistance: ≤ 7.5m Ω
 Insulation resistance: ≥ 1000 MΩ
 Dielectric withstanding voltage: 800 Vrms

Mechanical:
 Mating Cycles: ≥ 25 Cycles
 Engagement force: ≥ 45N
 Disengagement force: ≥ 5N
 Retention Force Latch: ≥ 110N
 Coding Efficiency: ≥ 150N
 Temperature Rating:
 -40°C to +105°C

Environmental:
 Lead free, RoHS compliant



PACKAGED ON TAPE & REEL

UNLESS OTHERWISE SPECIFIED ALL DIMENSIONS ARE MILLIMETERS. TOLERANCES: EXCEPT AS NOTED			 909 Rahway Avenue, Union, NJ 07083 Phone: 908-687-5000 Fax: 908-687-5710	
X	MM ± 0.50	ANGLE ± 5°		
.X	± 0.30		TITLE MINI FAKRA RIGHT ANGLE PLUG	
.XX	± 0.20			
DRAWN JJ 9/13/21				
CHECKED KC 9/13/21			SIZE X PART NO. MHSD-04X-AM-PRX-T/R REV. D	
APPROVED			REF: S00013T SCALE: NTS SHEET 1 OF 4	
THIS DRAWING CONTAINS INFORMATION THAT IS PROPRIETARY AND SHOULD NOT BE USED WITHOUT PRIOR WRITTEN PERMISSION FROM ADAM TECH				

6

5

4

3

2

1

APPROVED: _____

DATE: _____ TITLE: _____

Rev	AWO #	Description	Date	Appr
-----	-------	-------------	------	------

SEE SHT 1 OF 4 FOR REVISION

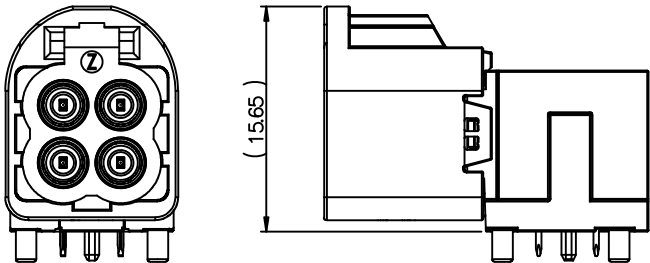
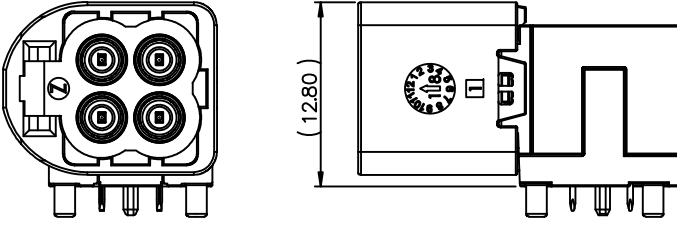
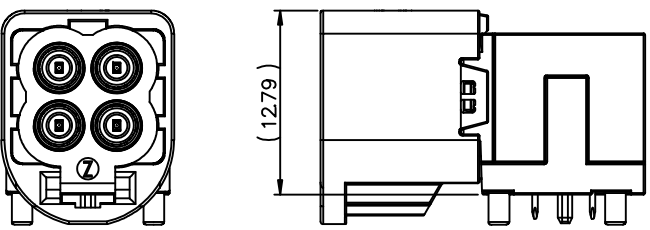
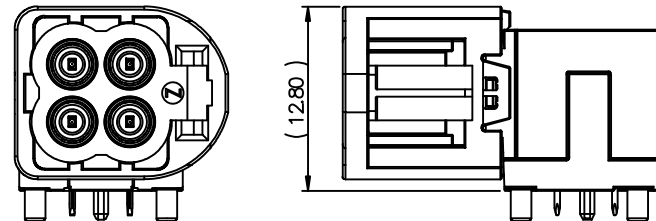
D	PartNumber	MHSD-04X-AM-PRA-T/R	MHSD-04X-AM-PRC-T/R
	Direction	STANDARD ORIENTATION 	90° ORIENTATION 
C	PartNumber	MHSD-04X-AM-PRB-T/R	MHSD-04X-AM-PRD-T/R
	Direction	180° ORIENTATION 	270° ORIENTATION 

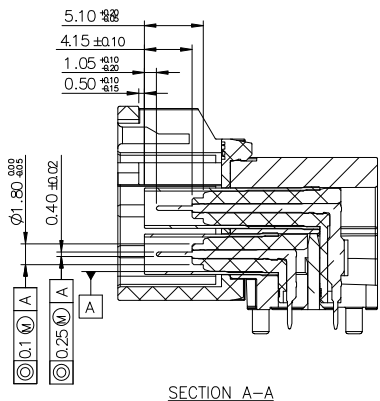

SECTION A-A

UNLESS OTHERWISE SPECIFIED ALL DIMENSIONS ARE MILLIMETERS. TOLERANCES: EXCEPT AS NOTED

	MM	ANGLE
X.	± 0.50	± 5°
.X	± 0.30	
.XX	± 0.20	

DRAWN	JJ	9/13/21
CHECKED	KC	9/13/21
APPROVED		

THIS DRAWING CONTAINS INFORMATION THAT IS PROPRIETARY AND SHOULD NOT BE USED WITHOUT PRIOR WRITTEN PERMISSION FROM ADAM TECH

ADAM TECH 909 Rahway Avenue, Union, NJ 07083
Phone: 908-687-5000 Fax: 908-687-5710

TITLE MINI FAKRA RIGHT ANGLE PLUG		
SIZE X	PART NO. MHSD-04X-AM-PRX-T/R	REV. D
REF: S00013T	SCALE: NTS	SHEET 2 OF 4

6

5

4

3

2

1

6

5

4

3

2

1









APPROVED: _____

DATE: _____ TITLE: _____

Rev	AWO #	Description	Date	Appr
-----	-------	-------------	------	------

SEE SHT 1 OF 4 FOR REVISION

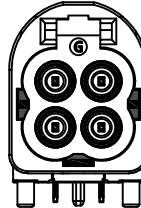
MHSD-04X-AM-PRX-T/R

Coding	A	B	C	D	E	F	G
Plug							
Color	BLACK	WHITE	BLUE	CLARET VIOLET	GREEN	BROWN	PLATINUM GREY
Coding	Z						
Plug							
Color	WATER BLUE						

UNLESS OTHERWISE SPECIFIED ALL DIMENSIONS ARE MILLIMETERS. TOLERANCES: EXCEPT AS NOTED

	MM	ANGLE
X.	± 0.50	± 5°
.X	± 0.30	
.XX	± 0.20	

DRAWN	JJ	9/13/21
CHECKED	KC	9/13/21
APPROVED		

THIS DRAWING CONTAINS INFORMATION THAT IS PROPRIETARY AND SHOULD NOT BE USED WITHOUT PRIOR WRITTEN PERMISSION FROM ADAM TECH

ADAM TECH 909 Rahway Avenue,
Union, NJ 07083
Phone: 908-687-5000
Fax: 908-687-5710

TITLE	MINI FAKRA RIGHT ANGLE PLUG		
SIZE	PART NO.	MHSD-04X-AM-PRX-T/R	REV. D
REF: S00013T	SCALE: NTS	SHEET 3 OF 4	

6

5

4

3

2

1

6

5

4

3

2

1

APPROVED: _____

DATE: _____ TITLE: _____

Rev	AWO #	Description	Date	Appr
-----	-------	-------------	------	------

SEE SHT 1 OF 4 FOR REVISION

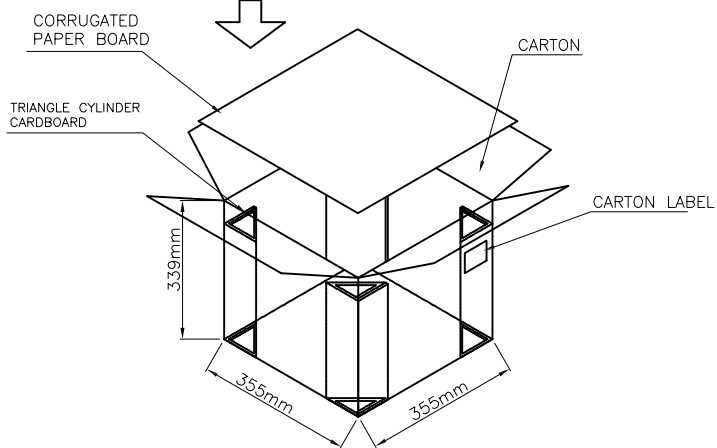
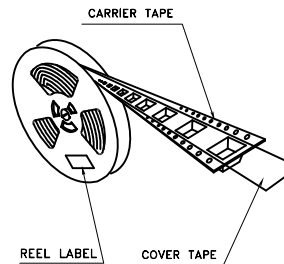
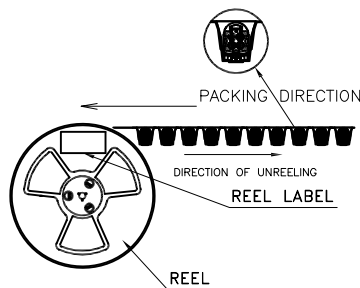
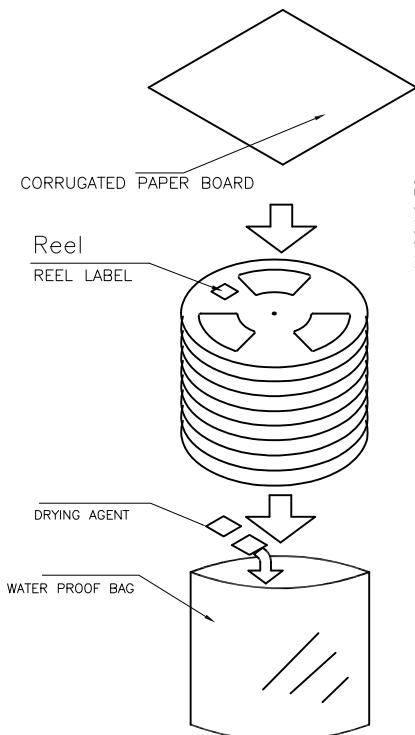
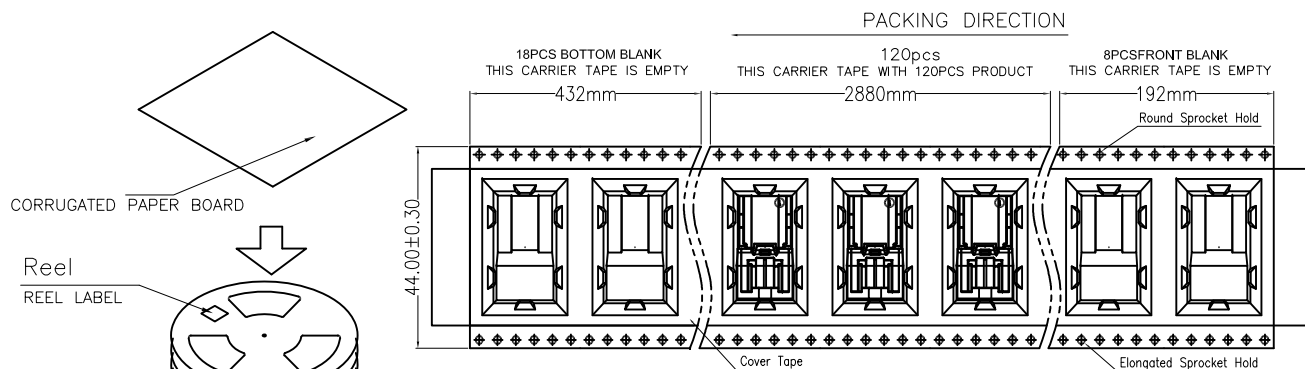

QUANTITY		WEIGHT	
PCS/REEL	REEL/CARTON	N.W(kg)	G.W(kg)
120	6	7.38	8.38

NOTES

1. MATERIALS: PS
2. PACKING: TAPE REEL(120PCS/REEL,720PCS/CARTON)
3. RoHS

All Material in According with the RoHS Environment Related Substances List Controlled.

UNLESS OTHERWISE SPECIFIED ALL DIMENSIONS ARE MILLIMETERS. TOLERANCES: EXCEPT AS NOTED		
	MM	ANGLE
X.	± 0.50	± 5°
.X	± 0.30	
.XX	± 0.20	
DRAWN	JJ	9/13/21
CHECKED	KC	9/13/21
APPROVED		
THIS DRAWING CONTAINS INFORMATION THAT IS PROPRIETARY AND SHOULD NOT BE USED WITHOUT PRIOR WRITTEN PERMISSION FROM ADAM TECH		

ADAM TECH

909 Rahway Avenue,
Union, NJ 07083
Phone: 908-687-5000
Fax: 908-687-5710

TITLE			REV. D
MINI FAKRA RIGHT ANGLE PLUG			
SIZE X	PART NO. MHSD-04X-AM-PRX-T/R	REV. D	
REF: S00013T	SCALE: NTS	SHEET 4 OF 4	

6

5

4

3

2

1