

# PXP6014/02P/CR Datasheet

**Product Name // Screwed Front Panel Mount Connector**  
**PXM6014 Series 2 Contact Plug Crimp/Solder Termination**  
**(contacts available separately) Plastic Body**

[View Product Page](#)

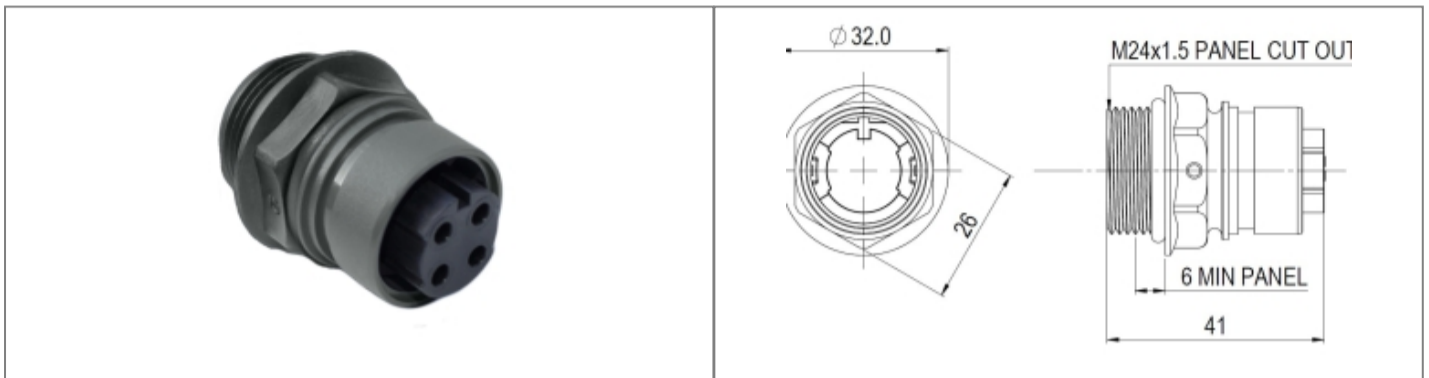

## // Product Description:

- ⊗ Screwed Front Panel Mount Connectors
- ⊗ Water and dustproof to IP66, IP68, IP69K when mated with compatible connector
- ⊗ 30 degree push twist locking, tamperproof lock prevents accidental un-mating
- ⊗ Plug
- ⊗ 2 Contacts
- ⊗ Crimp/solder termination with contacts and fitting tool available separately
- ⊗ Plastic Body
- ⊗ PXP6083 Sealing Cap available separately to maintain IP rating of unmated connectors
- ⊗ Mate with PXP6010 Series Flex Connectors

## // General Information:

<b>Product Display Title:</b>	Screwed Front Panel Mount Connectors
<b>Product Family:</b>	Circular Power Connectors
<b>Product Series:</b>	6000 Series Buccaneer
<b>Body Colour:</b>	Grey
<b>Body Material:</b>	Polycarbonate/Polybutylene Terephthalate (PC/PBT)
<b>Body Material Type:</b>	Plastic Body
<b>Contact Type:</b>	Plug Contact
<b>Coupling Type:</b>	Push-Twist
<b>Diameter Over Coupling Ring Mm:</b>	32mm
<b>Flamability Rating:</b>	UL94V-0
<b>Function:</b>	Front Panel Mount Connector
<b>Insulation Resistance:</b>	>10 <sup>6</sup> MΩ @500V DC
<b>Ip Rating:</b>	IP66, IP68, IP69K
<b>Max Contact Accomodation Awg:</b>	20AWG
<b>Min Contact Accomodation Awg:</b>	16AWG
<b>Max Contact Accomodation Mm2:</b>	1.3mm <sup>2</sup>
<b>Min Contact Accomodation Mm2:</b>	0.52mm <sup>2</sup>
<b>Max Operating Temperature:</b>	+120°C
<b>Min Operating Temperature:</b>	-40°C
<b>Min Panel Thickness:</b>	6mm
<b>Number Of Contacts:</b>	2 Contacts
<b>Panel Cut Out:</b>	M24x1.5
<b>Rohs Compliant:</b>	Yes
<b>Salt Spray Corrosion Test:</b>	EN60068-2-52 Test Kb Salt Mist (Cyclic) Marine Severity Level 1
<b>Thread Size:</b>	M24x1.5
<b>Voltage Max:</b>	277V

### // Product PDF Links

[6000 Series power connectors...](#)

[6000 Series metal body power...](#)

### // Product 3D CAD Model Links

[PXP6014/02P/CR3D CAD Model](#)