

ITEM NO.	PART NUMBER	DESCRIPTION	QTY.	COMPONENT NOTES
1	50-00681	Connector, 3 pin M8 A-code socket, 8x15.1 mm, gold plated, molding style, solder cup, IP67, shielded	2	
2	30-01571	Wire, 3C TS, 24 AWG, UL20387, 300V, 105C, 60C oil, UV, 5.2 mm, shielded, VW-1, PVC, 80A, black	1	
3	24-00378	Overmold, M8 plug and jack, 180°	2	PVC, black

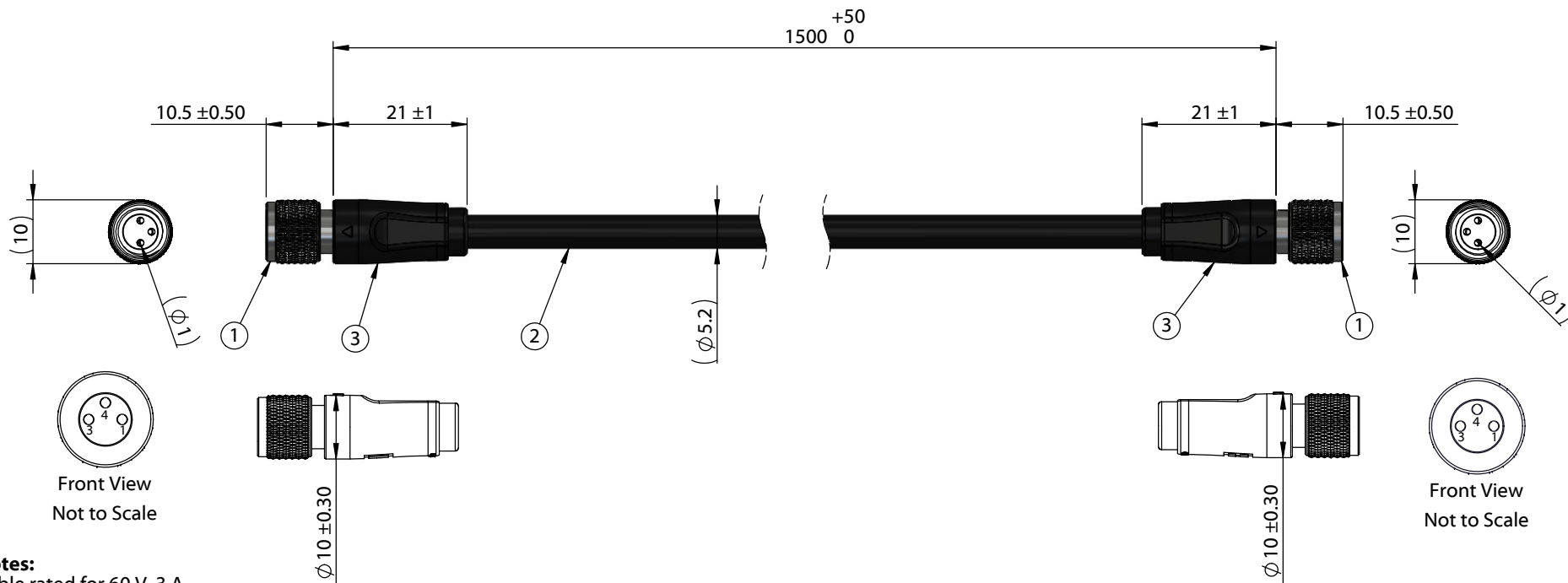

Notes:
 Cable rated for 60 V, 3 A
 Temperature: -40 ~ 105 °C
 Oil resistant up to 60 °C
 Water resistant up to 75 °C
 UV resistant

IP67 waterproof rating when mated with corresponding (IP67) connector

Functionally equivalent components may be substituted

Wiring Diagram		
50-00681	wire color	50-00681
1	red	1
3	black	3
4	white	4
Shell	Shield	Shell

Revision:	Date:	Description:	Prepared:	Notes:	<h1>TENSILITY</h1> <p>tel 1.541.323.3228 800 877.670.7118 fax 1.541.323.4202 web tensility.com</p>
A	3/4/2022	Initial release	Verified:		
			Dimensions are in millimeters. Tolerances: X: ± 0.5 mm X.X: ± 0.3 mm X.XX: ± 0.05 mm	Function test: no open, no short circuit, no intermittent	Size: Part number: A 10-04151
				Description: Cable, 1500mm, 1.0 mm 3C 50-00681 M8 socket to same, 24 AWG, 30-01571 wire, shielded	

5

4

3

2

1