

# SAC-5P- 5,0-PUR/M12FRK PE SH - Power cable



1414801

<https://www.phoenixcontact.com/us/products/1414801>

Please be informed that the data shown in this PDF document is generated from our online catalog. Please find the complete data in the user documentation. Our general terms of use for downloads are valid.

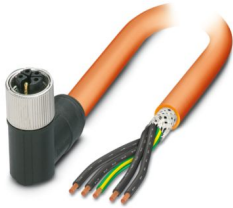

Power cable, 5-position, PUR halogen-free, orange RAL 2003, shielded, Advanced Shielding Technology, free cable end, on Socket angled M12, coding: K, cable length: 5 m, for AC current up to 16 A/690 V

## Your advantages

- Easy and safe: 100 % electrically tested plug-in components
- Protection against mismatching, thanks to special K-coding
- Shield power reliably – 360° shielding to reduce electromagnetic loads
- Our standard: robust halogen-free PUR cable

## Commercial data

Item number	1414801
Packing unit	1 pc
Minimum order quantity	1 pc
Sales key	BF05
Product key	BF1CDQ
Catalog page	Page 292 (C-2-2019)
GTIN	4055626034355
Weight per piece (including packing)	1,026.76 g
Weight per piece (excluding packing)	1,026.76 g
Customs tariff number	85444290
Country of origin	DE

# SAC-5P- 5,0-PUR/M12FRK PE SH - Power cable



1414801

<https://www.phoenixcontact.com/us/products/1414801>

## Technical data

### Product properties

Product type	Power cable
Application	Power supply
Number of positions	5
No. of cable outlets	1
Shielded	yes
Coding	K

### Insulation characteristics

Overvoltage category	III
Degree of pollution	3

### Material specifications

Flammability rating according to UL 94	V0
Material of grip body	PP
Contact material	CuZn
Contact surface material	Ni/Au
Contact carrier material	PA
Material for screw connection	Zinc die-cast, nickel-plated

### Electrical properties

Insulation resistance	$\geq 100 \text{ M}\Omega$
Nominal voltage $U_N$	690 V AC
Nominal current $I_N$	16 A

### Mechanical properties

#### Mechanical data

Insertion/withdrawal cycles	$\geq 100$
-----------------------------	------------

### Connector

#### Connection 1

Type	free cable end
------	----------------

#### Connection 2

Type	Socket angled M12
Coding type	K (Power)

### Cable/line

Cable length	5 m
--------------	-----

PUR halogen-free orange [PUR]

# SAC-5P- 5,0-PUR/M12FRK PE SH - Power cable



1414801

<https://www.phoenixcontact.com/us/products/1414801>

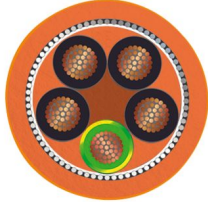
Dimensional drawing	
Cable weight	209 kg/km
UL AWM Style	22078 / 11560 (90 °C / 1000 V)
Number of positions	5
Shielded	yes
Cable type	PUR halogen-free orange [PUR]
Conductor cross section	5x 2.5 mm <sup>2</sup>
Wire diameter incl. insulation	2.8 mm ±0.1 mm
External cable diameter	10.30 mm ±0.3 mm
Outer sheath, material	PUR
External sheath, color	orange RAL 2003
Conductor material	Bare Cu litz wires
Material wire insulation	PP
Single wire, color	black 1, black 2, black 3, black 4, green/yellow
Thickness, insulation	≥ 0.36 mm
Thickness, outer sheath	approx. 1.15 mm
Max. conductor resistance	≤ 8 Ω/km (at 20 °C)
Insulation resistance	≥ 1 GΩ*km (at 20 °C)
Nominal voltage, cable	≤ 1000 V AC
Test voltage	≥ 10000 V AC (Spark test)
Minimum bending radius, fixed installation	5 x D
Minimum bending radius, flexible installation	10 x D
Smallest bending radius, fixed installation	52 mm
Smallest bending radius, movable installation	103 mm
Max. bending cycles	2000000
Halogen-free	in accordance with DIN VDE 0472 part 815 in accordance with DIN EN 50267-2-1
Flame resistance	According to UL 758/1581 (Cable Flame) according to UL 758/1581 FT1 According to DIN EN 60332-1-2
Resistance to oil	according to DIN EN 60811-404, 168 h at 100 °C
Other resistance	Hydrolysis and microbe resistant as per VDE 0282 section 10 Low adhesion abrasion-resistant Resistant to salt water
Ambient temperature (operation)	-50 °C ... 90 °C (cable, fixed installation) -30 °C ... 90 °C (Cable, flexible installation)

# SAC-5P- 5,0-PUR/M12FRK PE SH - Power cable



1414801

<https://www.phoenixcontact.com/us/products/1414801>

## Environmental and real-life conditions

### Ambient conditions

Degree of protection	IP65
	IP67 (without preloading, as additional test in accordance with IEC 60529)
Ambient temperature (operation)	-25 °C ... 85 °C (Plug / socket)

## Standards and regulations

Standard designation	M12 connector
Standards/specifications	IEC 61076-2-111

# SAC-5P- 5,0-PUR/M12FRK PE SH - Power cable



1414801

<https://www.phoenixcontact.com/us/products/1414801>

## Drawings

Circuit diagram

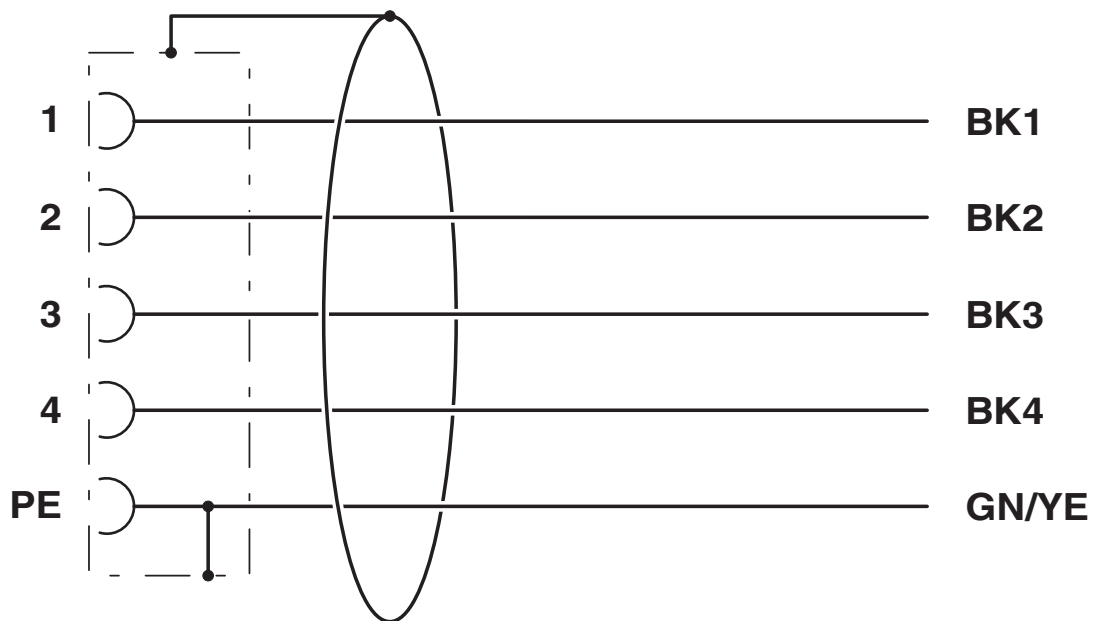

Schematic diagram

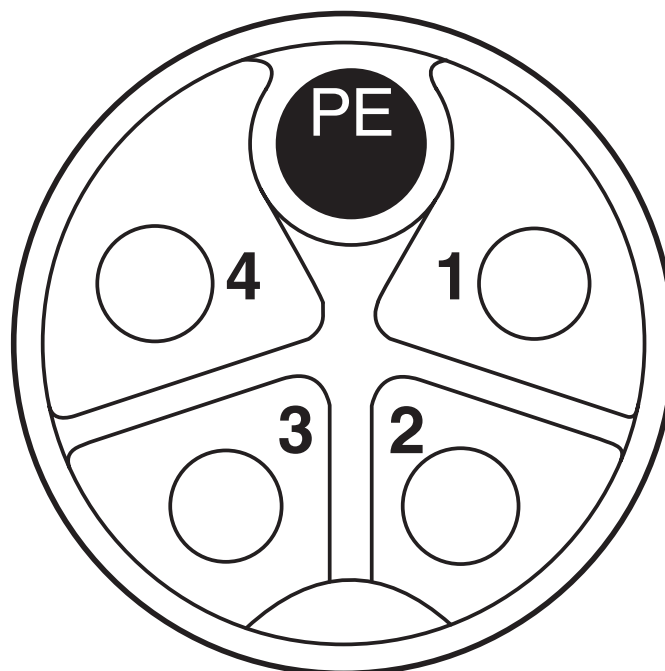

Pin assignment of M12 socket, 5-pos., K-coded, socket side view

# SAC-5P- 5,0-PUR/M12FRK PE SH - Power cable



1414801

<https://www.phoenixcontact.com/us/products/1414801>

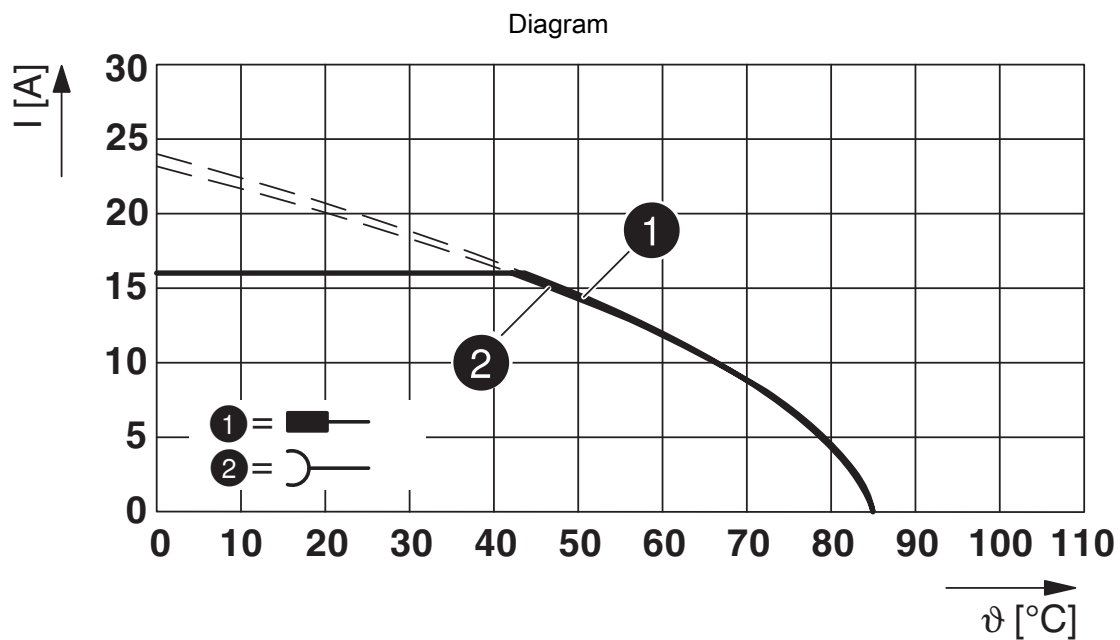

Base curve

Dimensional drawing

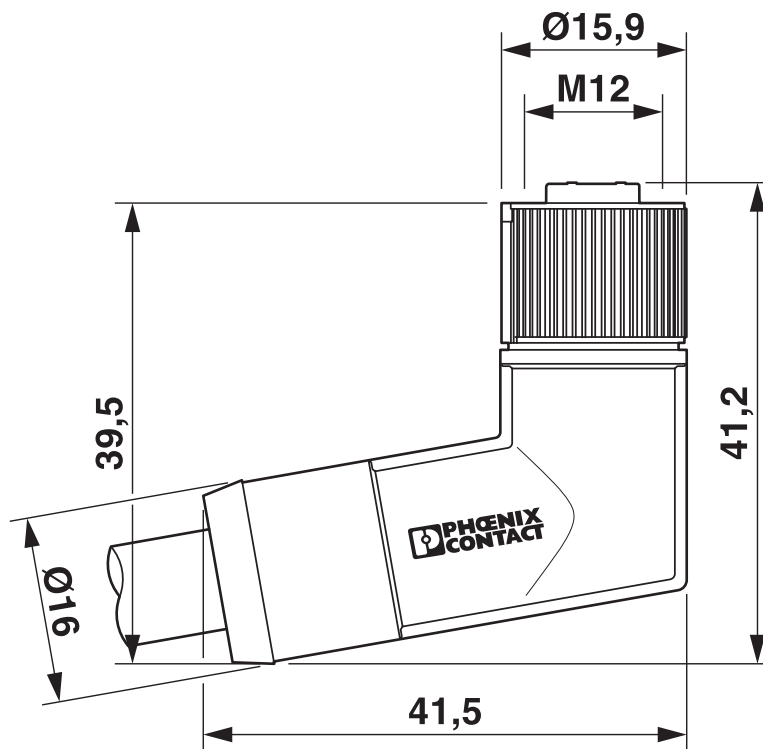

M12 x 1 socket, angled

# SAC-5P- 5,0-PUR/M12FRK PE SH - Power cable





1414801

<https://www.phoenixcontact.com/us/products/1414801>

## Approvals

To download certificates, visit the product detail page: <https://www.phoenixcontact.com/us/products/1414801>

 <b>UL Listed</b> Approval ID: E468743				
	Nominal voltage $U_N$	Nominal current $I_N$	Cross section AWG	Cross section $mm^2$
	600 V	16 A	-	- 14

 <b>cUL Listed</b> Approval ID: E468743				
	Nominal voltage $U_N$	Nominal current $I_N$	Cross section AWG	Cross section $mm^2$
	600 V	16 A	- 14	-

 <b>EAC-RoHS</b> Approval ID: RU D-DE.HB35.B.00387	
---	--

<b>cULus Listed</b>	
---------------------	--

# SAC-5P- 5,0-PUR/M12FRK PE SH - Power cable



1414801

<https://www.phoenixcontact.com/us/products/1414801>

## Classifications

### ECLASS

ECLASS-11.0	27060311
ECLASS-12.0	27060311
ECLASS-13.0	27060327

### ETIM

ETIM 9.0	EC001855
----------	----------

### UNSPSC

UNSPSC 21.0	26121600
-------------	----------



# SAC-5P- 5,0-PUR/M12FRK PE SH - Power cable



1414801

<https://www.phoenixcontact.com/us/products/1414801>

## Environmental product compliance

### EU RoHS

Fulfills EU RoHS substance requirements	Yes, No exemptions
---	--------------------

### China RoHS

Environment friendly use period (EFUP)	EFUP-E
	No hazardous substances above the limits

### EU REACH SVHC

REACH candidate substance (CAS No.)	No substance above 0.1 wt%
-------------------------------------	----------------------------

# SAC-5P- 5,0-PUR/M12FRK PE SH - Power cable



1414801

<https://www.phoenixcontact.com/us/products/1414801>

## Accessories

### PROT M12 MS PWR - Screw plug

1092802

<https://www.phoenixcontact.com/us/products/1092802>



An M12 screw plug for the unoccupied M12 females of the M12 POWER connectors, boxes, and flush-type connectors

---

### UCT-WMT (23X4) - Conductor marker

0801453

<https://www.phoenixcontact.com/us/products/0801453>



Conductor marker, Sheet, white, unlabeled, can be labeled with: TOPMARK NEO, TOPMARK LASER, BLUEMARK ID COLOR, BLUEMARK ID, BLUEMARK CLED, THERMOMARK PRIME, THERMOMARK CARD 2.0, THERMOMARK CARD, mounting type: insert, cable diameter range: 1.5 ... 35 mm, lettering field size: 23 x 4 mm, Number of individual labels: 30

# SAC-5P- 5,0-PUR/M12FRK PE SH - Power cable



1414801

<https://www.phoenixcontact.com/us/products/1414801>

## UC-WMT (23X4) - Conductor marker

0819411

<https://www.phoenixcontact.com/us/products/0819411>



Conductor marker, Sheet, white, unlabeled, can be labeled with: BLUEMARK ID COLOR, BLUEMARK ID, BLUEMARK CLED, PLOTMARK, CMS-P1-PLOTTER, mounting type: insert, cable diameter range: 1.5 ... 35 mm, lettering field size: 23 x 4 mm, Number of individual labels: 24

---

## US-WMT (23X4) - Cable marker

0828769

<https://www.phoenixcontact.com/us/products/0828769>



Cable marker, Card, white, unlabeled, can be labeled with: BLUEMARK ID COLOR, BLUEMARK ID, THERMOMARK PRIME, THERMOMARK CARD 2.0, THERMOMARK CARD, mounting type: slide-on, cable diameter range: 1.5 ... 35 mm, lettering field size: 23 x 4 mm, Number of individual labels: 56

# SAC-5P- 5,0-PUR/M12FRK PE SH - Power cable



1414801

<https://www.phoenixcontact.com/us/products/1414801>

## WMTW (23X4)R - Cable marker

0831004

<https://www.phoenixcontact.com/us/products/0831004>



Cable marker, Roll, white, unlabeled, can be labeled with: THERMOMARK E.300 (D)/600 (D), THERMOMARK ROLL 2.0, THERMOMARK ROLL, THERMOMARK ROLL X1, THERMOMARK ROLLMASTER 300/600, THERMOMARK X1.2, mounting type: insert, cable diameter range: 1.5 ... 35 mm, lettering field size: 23 x 4 mm, Number of individual labels: 3000

---

## WP-EC TPE HF 13,0 BK - Transition sleeve from hose to cable

3240975

<https://www.phoenixcontact.com/us/products/3240975>



Transition sleeve from hose to cable, material: TPE, color: black, flammability rating in acc. with UL 94: HB

# SAC-5P- 5,0-PUR/M12FRK PE SH - Power cable



1414801

<https://www.phoenixcontact.com/us/products/1414801>

## WP-PA HF 13,0 BK - Protective hose

3240681

<https://www.phoenixcontact.com/us/products/3240681>



Protective hose, material: PA 6, UV-resistant: yes, flexible, degree of protection: IP68, color: black, flammability rating in acc. with UL 94: V0, inner diameter: 10 mm, Total length: 50 m

---

## WP-PA HF-HB 13,0 BK - Protective hose

3240839

<https://www.phoenixcontact.com/us/products/3240839>



Protective hose, material: PA 6, UV-resistant: yes, flexible, degree of protection: IP68, color: black, flammability rating in acc. with UL 94: HB, inner diameter: 10 mm, Total length: 50 m

# SAC-5P- 5,0-PUR/M12FRK PE SH - Power cable



1414801

<https://www.phoenixcontact.com/us/products/1414801>

## SAC BIT M12-D16 - Tool

1200305

<https://www.phoenixcontact.com/us/products/1200305>

Nut for assembling sensor/actuator cables with M12 connector and M12 connectors for assembly, knurl diameter: 16 mm, for 4 mm hexagonal drive



---

## TSD 04 SAC - Torque screwdriver

1208429

<https://www.phoenixcontact.com/us/products/1208429>

Torque screwdriver, with preset torque of 0.4 Nm and 4 mm hexagonal drive for M12 connectors



# SAC-5P- 5,0-PUR/M12FRK PE SH - Power cable

1414801

<https://www.phoenixcontact.com/us/products/1414801>



## TSD-M 1,2NM - Torque screwdriver

1212224

<https://www.phoenixcontact.com/us/products/1212224>



Torque screw driver, accuracy as per EN ISO 6789 standard, adjustable from 0.3 - 1.2 Nm

---

## TSD-M SAC-BIT ADAPTER - Adapter insert

1212600

<https://www.phoenixcontact.com/us/products/1212600>



Adapter bit for TSD-M...torque tools, E6.3-1/4" drive with 4 mm hexagon to accommodate SAC bits

## SAC-5P- 5,0-PUR/M12FRK PE SH - Power cable

1414801

<https://www.phoenixcontact.com/us/products/1414801>



## B-STIFT - Marker pen

1051993

<https://www.phoenixcontact.com/us/products/1051993>



Marker pen, for manual labeling of unprinted Zack strips, smear-proof and waterproof, line thickness 0.5 mm

---

## CUTFOX-S VDE - Diagonal cutter

1212207

<https://www.phoenixcontact.com/us/products/1212207>



Diagonal cutter for hard (piano wire) and soft wires, VDE 1000 V AC/1500 V DC tested



# SAC-5P- 5,0-PUR/M12FRK PE SH - Power cable



1414801

<https://www.phoenixcontact.com/us/products/1414801>

## WIREFOX-D 16 - Stripping tool

1212173

<https://www.phoenixcontact.com/us/products/1212173>



Stripping tool, for stripping lines (specially for fiber optics lines) of  $\varnothing$  4 - 16 mm

---

## WIREFOX-D 40 - Stripping tool

1212161

<https://www.phoenixcontact.com/us/products/1212161>



Stripping tool, for stripping cables of 4.5 mm - 40 mm- $\varnothing$ , insulation thickness of up to 4.5 mm, pivoting blade for round, lengthwise, and spiral cuts

# SAC-5P- 5,0-PUR/M12FRK PE SH - Power cable



1414801

<https://www.phoenixcontact.com/us/products/1414801>

## WIREFOX 10 - Stripping tool

1212150

<https://www.phoenixcontact.com/us/products/1212150>



Stripping tool, for cables and conductors from 0.02 - 10 mm<sup>2</sup>, self-adjusting, stripping length of up to 18 mm, cutting capacity of up to 10 mm<sup>2</sup> stranded/1.5 mm<sup>2</sup> solid, replaceable stripping blade

---

Phoenix Contact 2024 © - all rights reserved

<https://www.phoenixcontact.com>

Phoenix Contact USA  
586 Fulling Mill Road  
Middletown, PA 17057, United States  
(+717) 944-1300  
[info@phoenixcon.com](mailto:info@phoenixcon.com)