

THIS DOCUMENT IS SUBJECT TO CHANGE WITHOUT NOTICE. IT IS CONFIDENTIAL AND A PROPERTY OF Amphenol LTW. DISCLOSURE TO THIRD PARTY HAS TO BE AUTHORIZED BY Amphenol LTW.

REV.	ECN NO.	DATE	SIGN	DESCRIPTION
C	C210021	2021/01/07	Vicky	△C XI
D	C210228	2021/04/01	Vicky	△D X4
E	C222003	2022/12/27	Vicky	△E XI

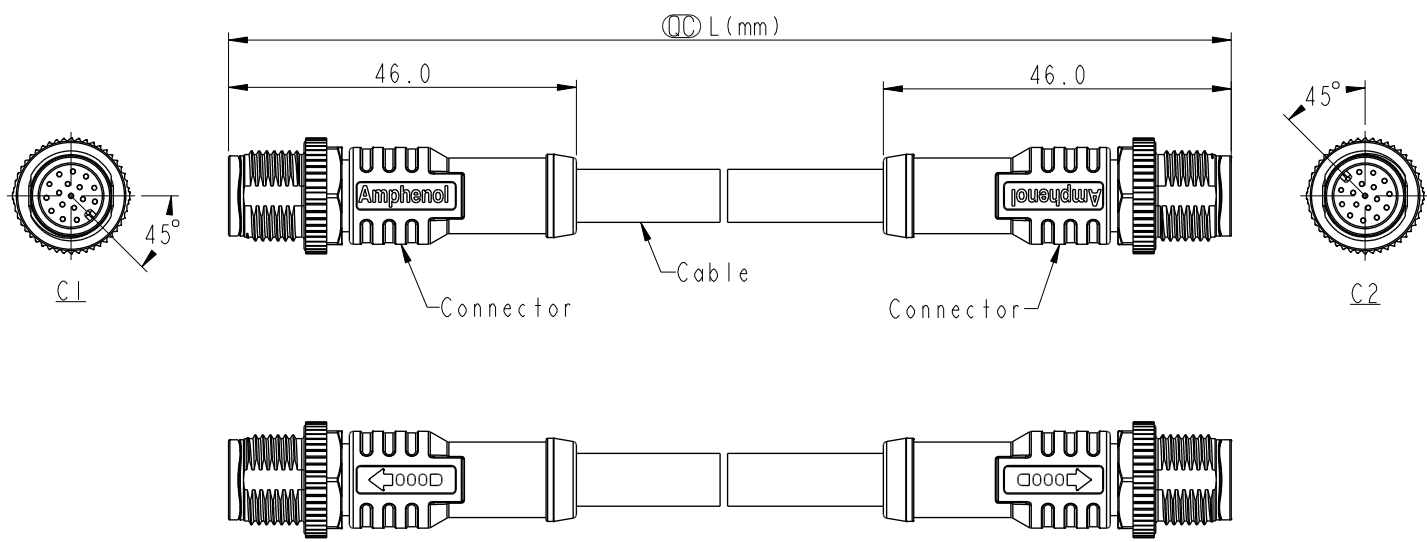





- Note:
- * RoHS Compliant
 - * Ⓛ Important dimension
 - * △E Waterproof rate: IP68, mated 1m/24h
IP69K, mated
 - * Connector
Housing: Thermoplastic, Black
Pin: Copper alloy, Gold plated
 - * △C Nut: Metal
Outer Mold: Thermoplastic, Black
 - * Cable: UL20549, PUR Jacket, Black
 - * Cable Length Tolerance:

0.5M < L ≤ 1M	: +60/-0 mm
1M < L ≤ 3M	: +120/-0 mm
3M < L ≤ 5M	: +160/-0 mm
5M < L ≤ 10M	: ±100 mm
10M < L ≤ 20M	: ±200 mm
20M < L ≤ 30M	: ±300 mm
30M < L ≤ 99M	: ±500 mm

UNIT: mm	Ⓛ	Ⓛ	TITLE ACC, SEN, A Code, DB-ENDED MM	△D
TOLERANCE $\pm 0.5\text{mm}$	SCALE 1:2	SIZE A4	SHEET 1 OF 2	REV. E
	WC-REV. A.5	Ⓛ : Inspection item		

Amphenol LTW
安費諾亮泰企業股份有限公司

ITEM NO.	DRAWN BY Vicky	DATE 2018-12-07
DWG NO. △A MI2AXXML-12AML-SBXXX	CHECKED BY Rita	DATE 2018-12-07
CUSTOMER ALTW	APPROVED BY Max	DATE 2018-12-07

 MI2AXXML-12AML-SBXXX XX: No. Of Pin							<table border="1" style="width: 100%; border-collapse: collapse;"> <tr> <td>17P</td> <td>7.0</td> <td rowspan="3" style="text-align: center;">26</td> <td>M12A17ML-12AML-SBXXX</td> </tr> <tr> <td>12P</td> <td rowspan="2" style="text-align: center;">6.0</td> <td>M12A12ML-12AML-SBXXX</td> </tr> <tr> <td>10P</td> <td>M12A10ML-12AML-SBXXX</td> </tr> <tr> <td>8P</td> <td>4.8</td> <td rowspan="3" style="text-align: center;">24</td> <td>M12A08ML-12AML-SBXXX</td> </tr> <tr> <td>6P</td> <td>5.0</td> <td>M12A06ML-12AML-SBXXX</td> </tr> <tr> <td>5P</td> <td>4.4</td> <td>M12A05ML-12AML-SBXXX</td> </tr> <tr> <td>4P</td> <td>4.0</td> <td rowspan="2" style="text-align: center;">22</td> <td>M12A04ML-12AML-SBXXX</td> </tr> <tr> <td>3P</td> <td>3.8</td> <td>M12A03ML-12AML-SBXXX</td> </tr> <tr> <td> Contacts</td> <td>Cable OD</td> <td>AWG</td> <td>Item No.</td> </tr> </table>	17P	7.0	26	M12A17ML-12AML-SBXXX	12P	6.0	M12A12ML-12AML-SBXXX	10P	M12A10ML-12AML-SBXXX	8P	4.8	24	M12A08ML-12AML-SBXXX	6P	5.0	M12A06ML-12AML-SBXXX	5P	4.4	M12A05ML-12AML-SBXXX	4P	4.0	22	M12A04ML-12AML-SBXXX	3P	3.8	M12A03ML-12AML-SBXXX	 Contacts	Cable OD	AWG	Item No.
17P	7.0	26	M12A17ML-12AML-SBXXX																																		
12P	6.0		M12A12ML-12AML-SBXXX																																		
10P			M12A10ML-12AML-SBXXX																																		
8P	4.8	24	M12A08ML-12AML-SBXXX																																		
6P	5.0		M12A06ML-12AML-SBXXX																																		
5P	4.4		M12A05ML-12AML-SBXXX																																		
4P	4.0	22	M12A04ML-12AML-SBXXX																																		
3P	3.8		M12A03ML-12AML-SBXXX																																		
 Contacts	Cable OD	AWG	Item No.																																		
						XXX: 0.5~99Meters A05: 0.5 Meter 1: 01 Meter 2: 02 Meters : 99: 99 Meters																															

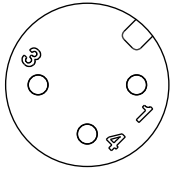
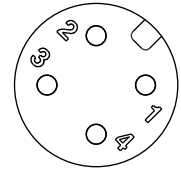
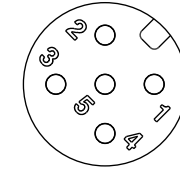
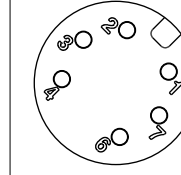
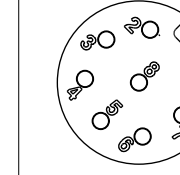
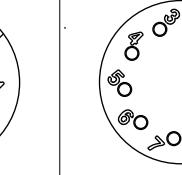
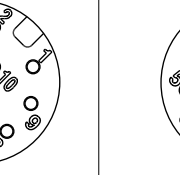
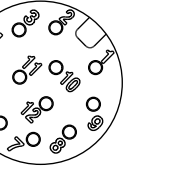
Pin Out	5 -- 4 Black 黑 3 Blue 藍 2 -- 1 Brown 棕	5 -- 4 Black 黑 3 Blue 藍 2 White 白 1 Brown 棕	5 Gray 灰 4 Black 黑 3 Blue 藍 2 White 白 1 Brown 棕	8 -- 7 Blue 藍 6 Pink 粉 5 -- 4 Yellow 黃 3 Green 綠 2 Brown 棕 1 White 白	8 Red 紅 7 Blue 藍 6 Pink 粉 5 Gray 灰 4 Yellow 黃 3 Green 綠 2 Brown 棕 1 White 白	12 -- 11 -- 10 Violet 紫 9 Black 黑 8 Red 紅 7 Blue 藍 6 Pink 粉 5 Gray 灰 4 Yellow 黃 3 Green 綠 2 Brown 棕 1 White 白	12 Red/Blue 紅/藍 11 Gray/Pink 灰/粉 10 Violet 紫 9 Black 黑 8 Red 紅 7 Blue 藍 6 Pink 粉 5 Gray 灰 4 Yellow 黃 3 Green 綠 2 Brown 棕 1 White 白	17 White/Gray 白/灰 16 Yellow/Brown 黃/棕 15 White/Yellow 白/黃 14 Brown/Green 棕/綠 13 White/Green 白/綠 12 Red/Blue 紅/藍 11 Gray/Pink 灰/粉 10 Violet 紫 9 Red 紅 8 Gray 灰 7 Black 黑 6 Yellow 黃 5 Pink 粉 4 Green 綠 3 White 白 2 Blue 藍 1 Brown 棕
CI & C2								

Pin Assignments Front View

UNIT:mm		TITLE ACC, SEN, A Code, DB-ENDED MM		Amphenol LTW	ITEM NO	DRAWN BY Vicky	DATE 2018-12-07
TOLERANCE ±0.5mm	SCALE 1:2	SIZE A4	SHEET 2 OF 2	安費諾亮泰企業股份有限公司	DWG NO  MI2AXXML-12AML-SBXXX	CHECKED BY Rita	DATE 2018-12-07
	REV. E	WC-REV. A.5	QC: Inspection item		CUSTOMER ALTW	APPROVED BY Max	DATE 2018-12-07