

5-583649-3 ✓ ACTIVE

AMP | AMP Twin-Leaf

TE Internal #: 5-583649-3

Socket Contact, Gold, Locking Lance Contact Retention, 22 – 18 AWG Wire Size, .3 – .9 mm² Wire Size, 642 – 1624 CMA Wire Size, Crimp, AMP Twin-Leaf

[View on TE.com >](#)



Connectors > Contacts > Connector Contacts

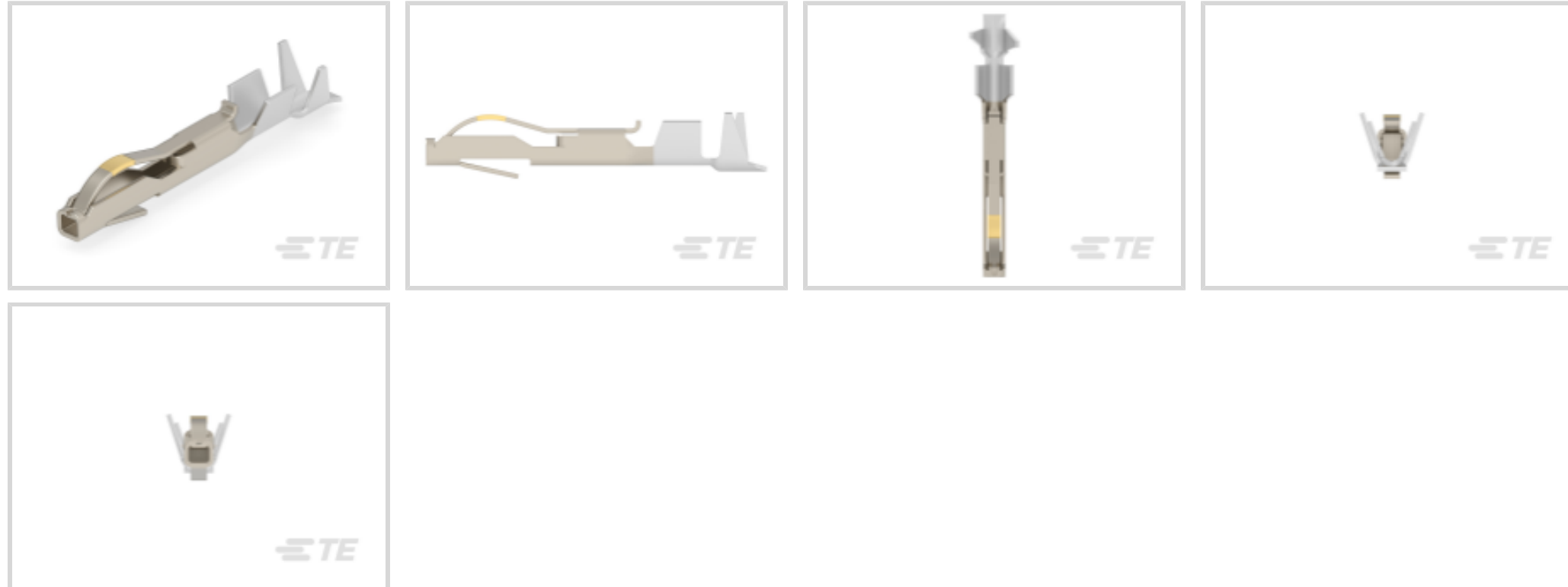

Contact Type: **Socket**

Contact Mating Area Plating Material: **Gold**

Wire Contact Termination Area Plating Material: **Tin-Lead**

Contact Retention Within Housing: **With**

Contact Retention Type Within Housing: **Locking Lance**

Features

Contact Features

Contact Underplating Material	Nickel
PCB Contact Termination Area Plating Material	Tin
Contact Type	Socket
Contact Mating Area Plating Material	Gold
Wire Contact Termination Area Plating Material	Tin-Lead
Contact Retention Within Housing	With
Contact Base Material	Phosphor Bronze
Contact Current Rating (Max)	5 A

Termination Features

Termination Method to Wire & Cable	Crimp
Product Terminates To	Wire & Cable

Mechanical Attachment

Contact Retention Type Within Housing	Locking Lance
---------------------------------------	---------------

Dimensions



Compatible Insulation Diameter Range	1.14 – 2.41 mm [.045 – .095 in]
--------------------------------------	---------------------------------

Wire Size	642 – 1624 CMA
-----------	----------------

Usage Conditions

Operating Temperature Range	-40 – 85 °C [-40 – 185 °F]
-----------------------------	----------------------------

Operation/Application

Circuit Application	Power & Signal
---------------------	----------------

Identification Marking

Contact Color Code	Violet
--------------------	--------

Packaging Features

Packaging Quantity	7000
--------------------	------

Packaging Method	Strip
------------------	-------

Product Compliance

[For compliance documentation, visit the product page on TE.com>](#)

EU RoHS Directive 2011/65/EU	Compliant
------------------------------	-----------

EU ELV Directive 2000/53/EC	Compliant
-----------------------------	-----------

China RoHS 2 Directive MIIT Order No 32, 2016	No Restricted Materials Above Threshold
---	---

EU REACH Regulation (EC) No. 1907/2006	Current ECHA Candidate List: JAN 2024 (240) Candidate List Declared Against: JAN 2024 (240) Does not contain REACH SVHC
--	---

Halogen Content	Low Halogen - Br, Cl, F, I < 900 ppm per homogenous material. Also BFR/CFR/PVC Free
-----------------	---

Solder Process Capability	Not applicable for solder process capability
---------------------------	--

Product Compliance Disclaimer

This information is provided based on reasonable inquiry of our suppliers and represents our current actual knowledge based on the information they provided. This information is subject to change. The part numbers that TE has identified as EU RoHS compliant have a maximum concentration of 0.1% by weight in homogenous materials for lead, hexavalent chromium, mercury, PBB, PBDE, DBP, BBP, DEHP, DIBP, and 0.01% for cadmium, or qualify for an exemption to these limits as defined in the Annexes of Directive 2011/65/EU (RoHS2). Finished electrical and electronic equipment products will be CE marked as required by Directive 2011/65/EU. Components may not be CE marked. Additionally, the part numbers that TE has identified as EU ELV compliant have a maximum concentration of 0.1% by weight in homogenous materials for lead, hexavalent chromium, and mercury, and 0.01% for cadmium, or qualify for an exemption to these limits as defined in the Annexes of Directive 2000/53/EC (ELV). Regarding the REACH Regulation, the information TE provides on SVHC in articles for this part number is based on the latest European Chemicals Agency (ECHA) 'Guidance on requirements for substances in articles' posted at this URL: <https://echa.europa.eu/guidance-documents/guidance-on-reach>

Compatible Parts



TE Part # 2837926-1
OCEAN-2.0-APPLICATOR-S-062F0900



TE Part # 2837926-2
OCEAN-2.0-APPLICATOR-S-062F0900



TE Part # 7-2837926-1
OCEAN-2.0-APPLICATOR-S-062F0900



TE Part # 7-2837926-2
OCEAN-2.0-APPLICATOR-S-062F0900



KIT
REPRESENTATION ONLY

TE Part # 7-2837926-7
OCEAN_2.0_SPARE_PART_KIT-062F0900

TE Part # 4-583717-7
TW LEAF CRP HSG. 23-POS.



TE Part # 4-583717-8
TW LEAF CRP HSG 3 POS

Also in the Series | AMP Twin-Leaf



Connector Contacts(15)



Insertion & Extraction Tools(1)

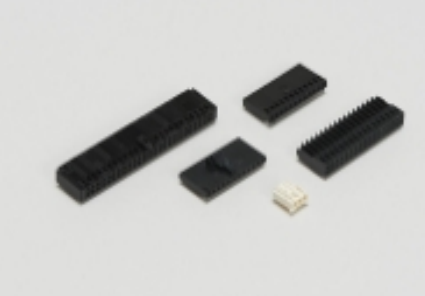

Wire-to-Board Connector Assemblies & Housings(17)

Customers Also Bought



TE Part #206838-2
RECEPT,SZ 23,CPC



TE Part #66399-4
III+ SKT,24-20,30AU/FL,LP



TE Part #3-66104-0
III+ SKT,24-20,TIN ,STRIP



TE Part #2151030-1
OCEAN_2.0_APPLICATION-S-062F110F

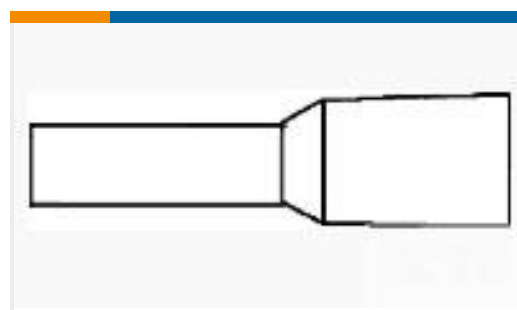

TE Part #966067-1
FER,WIRE,PL SLV,.50/20,L6,WHITE,LP



TE Part #172341-1
MINI UMNL PLUG HOUSING 12P

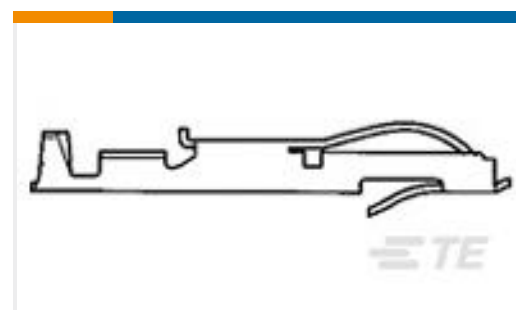

TE Part #5-583853-3
TWIN LEAF TERM. STRIP CSTL

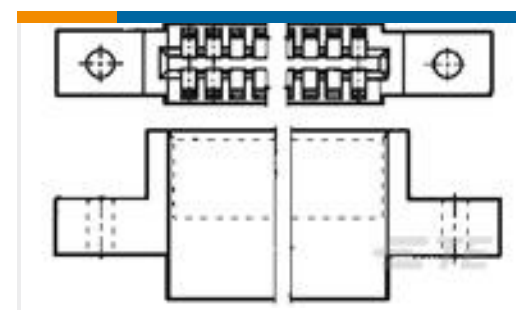

TE Part #1-583718-5
TW LEAF CRP HSG. 40-POS.

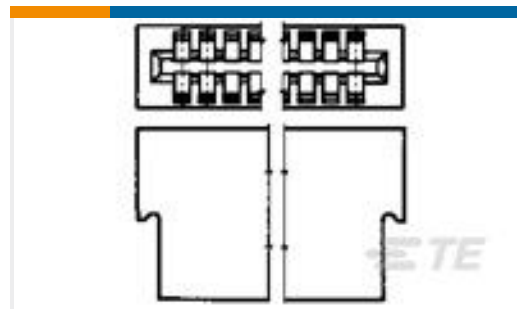

TE Part #1-583717-1
TW-LEAF CRP HSG 25 POS 100 C/L

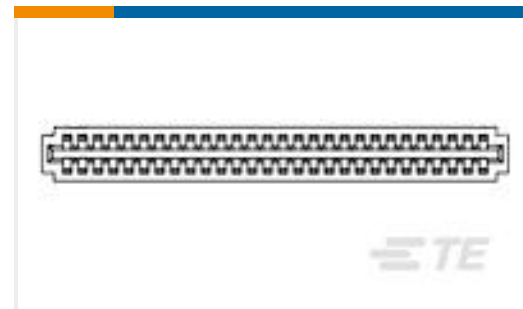

TE Part #583873-9
HOUSING CSTL 125 C/L 22 POS

Documents

Product Drawings

[CONT.CRP.SNAP TW.LF.STRIP](#)

English

CAD Files

[3D PDF](#)

3D

Customer View Model

[ENG_CVM_CVM_5-583649-3_BS_c-5-583649-3-bs.2d_dxf.zip](#)

English

Customer View Model

[ENG_CVM_CVM_5-583649-3_BS_c-5-583649-3-bs.3d_igs.zip](#)

English

Customer View Model

[ENG_CVM_CVM_5-583649-3_BS_c-5-583649-3-bs.3d_stp.zip](#)

English

By downloading the CAD file I accept and agree to the [Terms and Conditions](#) of use.

Product Specifications

[Application Specification](#)

English