

ESD-SR Snap-on Cores for Round Cables for Low & High Frequency (with case)

Overview

The KEMET ESD-SR Series snap-on toroidal cores are designed for use on round cables. The wide range of Manganese Zinc (MnZn) and Nickel Zinc (NiZn) options allows for targeting of specific frequency ranges.

EMI cores are part of a family of passive components which address the issues of noise or electromagnetic interference (EMI) in circuits or systems.

Applications

- Consumer electronics
- Airconditioners
- Power conditioners
- Refrigerators
- Washing machines
- Industrial equipment
- Medical equipment
- Adapters
- Audio-visual equipment
- Business multifunction printers

Benefits

- MnZn \leq 10 MHz (AM band range) and NiZn \leq 500 MHz (FM band range) options available
- Split construction
- Easy to install through its snap-on mechanism
- Quick solution for post-cable assembly noise issue
- Operating temperature range from -25°C to $+85^{\circ}\text{C}$
- UL94 V-0 flame retardant rated case



Part Number System

ESD-	SR-	S	38	G	R1
Series	Form Type	Shape type	Core Size Outer Dimension Code (mm)	Case Color	Core Material
ESD-	Snap-on	Blank = Sleeve S = Ring	See Table 1	Blank = Black G = Gray Note: Except ESD-SR-S10M = Beige	Blank = 700L (NiZn) M = 5H (MnZn) R1 = HR1 (Mn-Zn)

Turns and Impedance Characteristics

When the desired performance of an EMI core cannot be obtained with a single pass through the core, the impedance characteristics can be changed with multiple turns.

A turn is counted by the number of lead-wire windings which pass through the inner hole of the core. Windings on the outside of the core do not count.

See Figure 1 for examples of one, two, and three turns.

Adding turns will result in higher impedance while also lowering the effective frequency range.

See Figure 2 for an example.

Core Material and Effective Frequency Range

There are two ferrite material options for KEMET EMI Cores: Nickel Zinc (Ni-Zn) and Manganese Zinc (Mn-Zn). Each core material has a different resistance and effective frequency range. The MnZn core material has a lower resistance compared to the Ni-Zn; therefore, adequate insulation is required before use.

The Ni-Zn core material is typically effective for frequencies in the MHz band range such as the FM-band, while the Mn-Zn core material is typically effective for the kHz band range such as the AM-band. See Figure 3.

It is recommended to measure the actual frequency range effectiveness in the target application.

Figure 1 – How to count turns

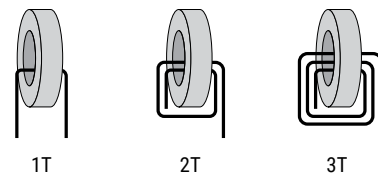

Figure 2 – Relationship between impedance and turn count. (Representative example: ESD-R-16C)

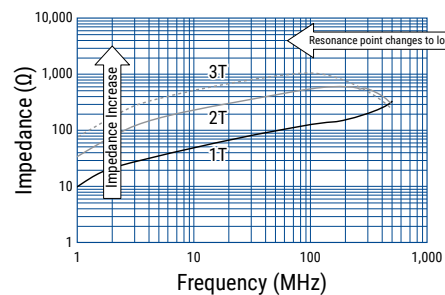
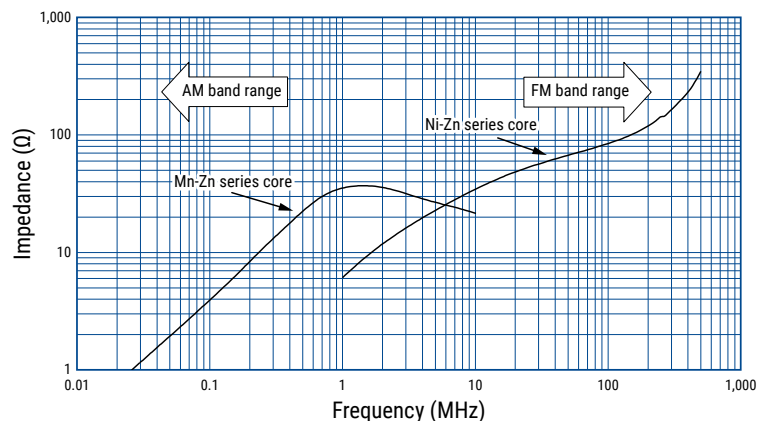

Figure 3 – Effective band range of Mn-Zn and Ni-Zn ferrite core material. (Representative example, measured with same-dimension ring core)



Magnetic Permeability of Ferrite Material

In order to achieve most efficient noise reduction, it is important to select the material according to the target frequency band.

Depending on its magnetic permeability, a particular ferrite material will be effective in a certain frequency band.

A schematic representation of the relationship between the magnetic permeability of each material and the corresponding effective band range is shown in Figure 4.

Materials with higher magnetic permeability are effective in the lower frequency range, while those with lower magnetic permeability are effective in the higher frequency range. Thus, Mn-Zn products are mainly used for reducing conduction noise, while Ni-Zn products are commonly used for radiation noise countermeasures.

The effective frequency range varies depending on core shape, size and number of turns.

This frequency dependence of the magnetic permeability as shown in the figure serves for reference purposes only and it should be tested on the actual device to determine its effectiveness.

S18H, S15H, 10H, 7H, 7HT, 5H, 5HT, HR1, 1400L and 700L are KEMET’s proprietary ferrite material names.

Other materials can also be available on request.

Figure 4 - Relationship between the magnetic permeability of each material and its effective frequency range

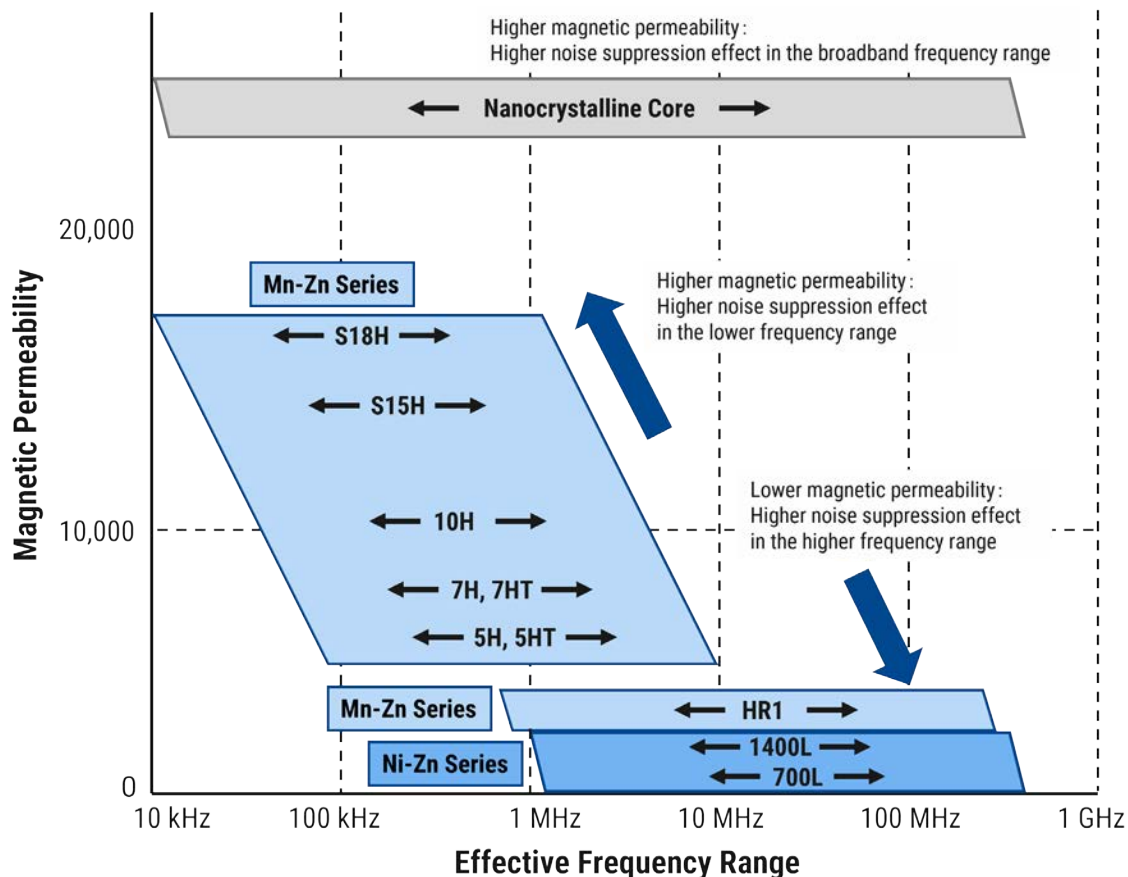

Environmental Compliance

All KEMET EMI cores are RoHS compliant.



Dimensions – Millimeters

ESD-SR Type

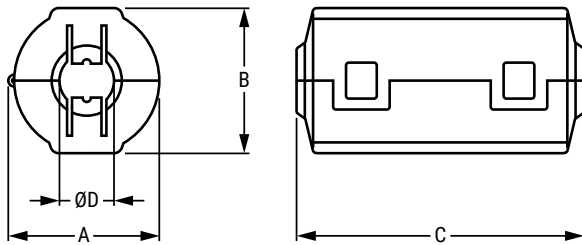

ESD-SR-S Type

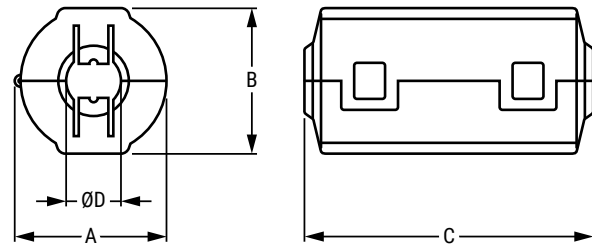

ESD-SR-S-M Type

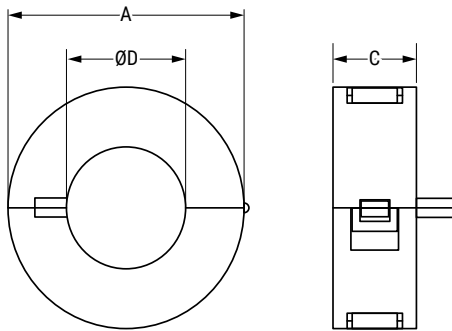

See Table 1 for dimensions

Installation Example

ESD-SR & ESD-SR-S Types



ESD-SR-S-M Type

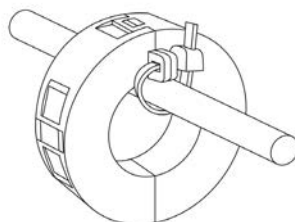

Performance Characteristics

Item	Performance Characteristics
Operating temperature	-25°C to +85°C
Frequency range	Low frequency and high frequency
Outer diameter	14.4 – 64 mm
Inner diameter	5.0 – 35 mm
Thickness	15.5 – 39 mm
Type	Case
Case flame resistant rating	UL94 V-0
Material	MnZn 5H, MnZn HR1 and NiZn 700L

Table 1 – Ratings & Part Number Reference

¹ Frequency range is for reference only. Please test with actual device before use.

Part Number	Dimensions (mm)				Weight (g)	Case Color	Frequency Range ¹		Material	
	A	B Maximum	C	ØD			≤ 10 MHz (AM band range)	≤ 500 MHz (FM band range)	MnZN	NiZn
ESD-SR-160620X-R1	16.5 Maximum	16.5	21.0 Maximum	6±1	7.0	Black		X	HR1	-
ESD-SR-100	16.5 Maximum	16.5	21.0 Maximum	6±1	7.2	Black		X	-	700L
ESD-SR-100G	16.5 Maximum	16.5	21.0 Maximum	6±1	7.2	Gray		X	-	700L
ESD-SR-130527X-R1	14.4 Maximum	14.2	28.0 Maximum	5±1	6.4	Black		X	HR1	-
ESD-SR-110	14.4 Maximum	14.2	28.0 Maximum	5±1	6.9	Black		X	-	700L
ESD-SR-110G	14.4 Maximum	14.2	28.0 Maximum	5±1	6.9	Gray		X	-	700L
ESD-SR-S10	15.5 Maximum	14.0	18.5 Maximum	6±0.5	4.1	Black		X	-	700L
ESD-SR-150632X-R1	16.0 Maximum	16.4	33.0 Maximum	6±1	12.5	Black		X	HR1	-
ESD-SR-120	16.0 Maximum	16.4	33.0 Maximum	6±1	13.3	Black		X	-	700L
ESD-SR-120G	16.0 Maximum	16.4	33.0 Maximum	6±1	13.3	Gray		X	-	700L
ESD-SR-190736X-R1	19.6 Maximum	20.3	37.4 Maximum	7±1	23.0	Black		X	HR1	-
ESD-SR-150	19.6 Maximum	20.3	37.4 Maximum	7±1	23.4	Black		X	-	700L
ESD-SR-150G	19.6 Maximum	20.3	37.4 Maximum	7±1	23.4	Gray		X	-	700L
ESD-SR-190938X-R1	20.2 Maximum	20.0	39.0 Maximum	9±1	20.6	Black		X	HR1	-
ESD-SR-160	20.2 Maximum	20.0	39.0 Maximum	9±1	22.7	Black		X	-	700L
ESD-SR-160G	20.2 Maximum	20.0	39.0 Maximum	9±1	22.7	Gray		X	-	700L
ESD-SR-311337X-R1	31.5 Maximum	31.6	38.0 Maximum	13±1	58.1	Black		X	HR1	-
ESD-SR-250	31.5 Maximum	31.6	38.0 Maximum	13±1	59.5	Black		X	-	700L
ESD-SR-250G	31.5 Maximum	31.6	38.0 Maximum	13±1	59.5	Gray		X	-	700L
ESD-SR-S16	23.0 Maximum	20.0	20.5 Maximum	8±0.5	12.9	Black		X	-	700L
ESD-SR-S25	33.0 Maximum	29.0	15.5 Maximum	14.5±1	21.3	Black		X	-	700L
ESD-SR-S10M	15.5 Maximum	14.0	18.5 Maximum	6.0±0.5	4.1	Beige	X		5H	-
ESD-SR-S38M	44.0 ±1.0	-	16.0 ±1.0	19 ± 1.0	58.0	Black	X		5H	-
ESD-SR-S47M	53.0 ±1.0	-	19.0 ±1.0	26.5 ± 1.0	89.0	Black	X		5H	-
ESD-SR-S57M	64.0 ±1.0	-	23.5 ±1.0	35.5 ± 1.0	159.0	Black	X		5H	-

Impedance vs. Frequency

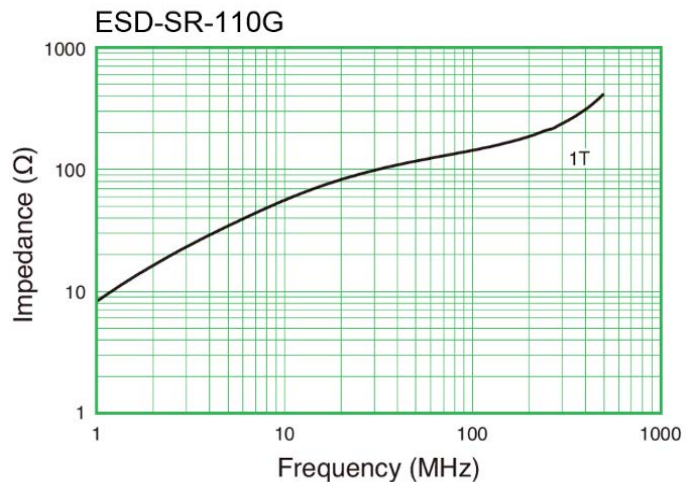
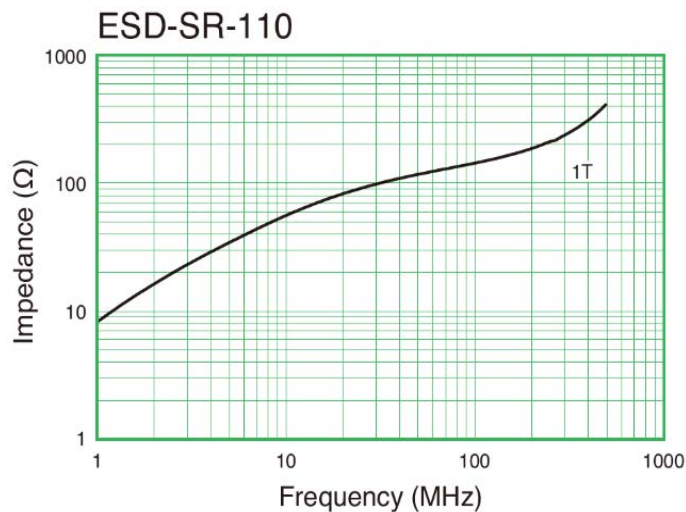
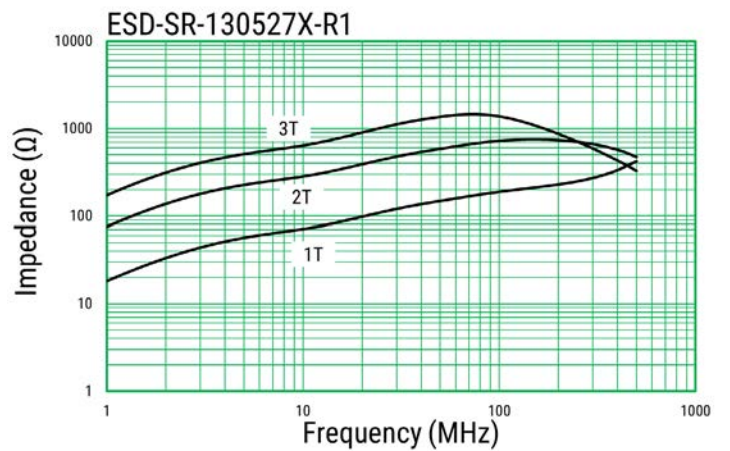
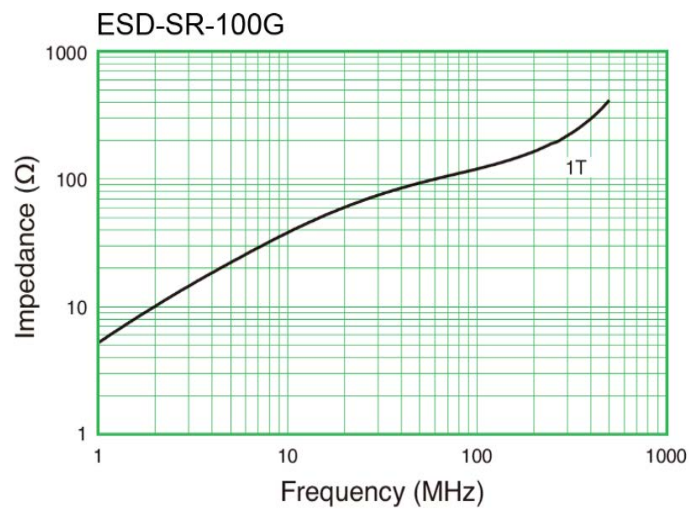
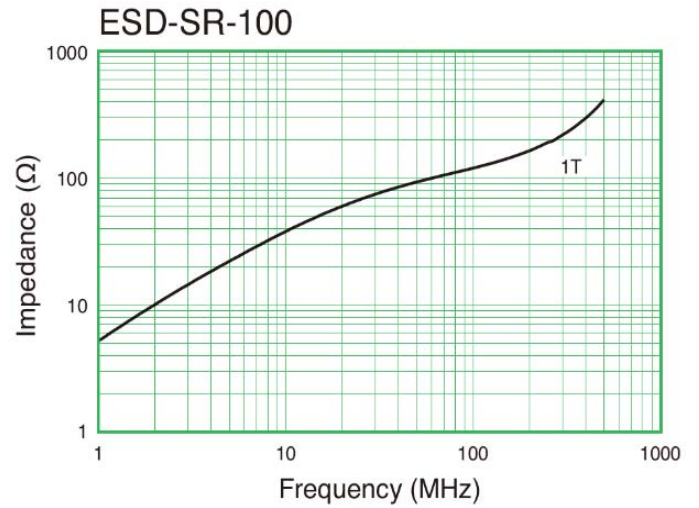
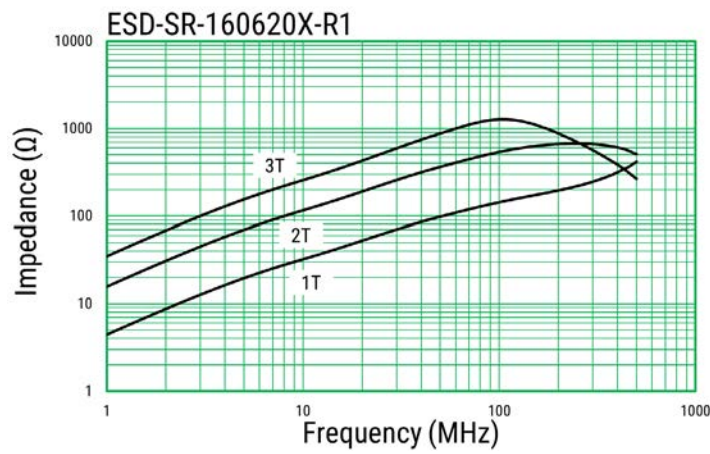

Impedance vs. Frequency cont.

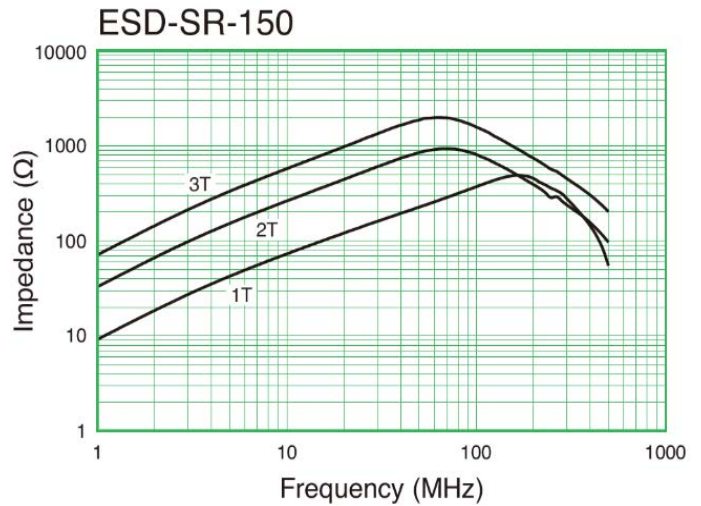
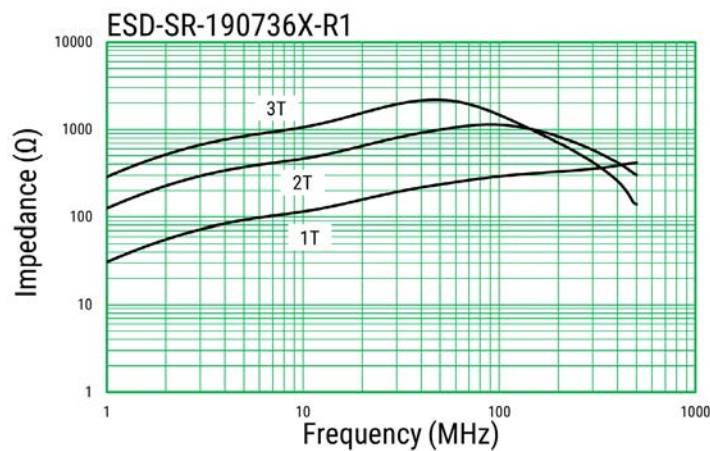
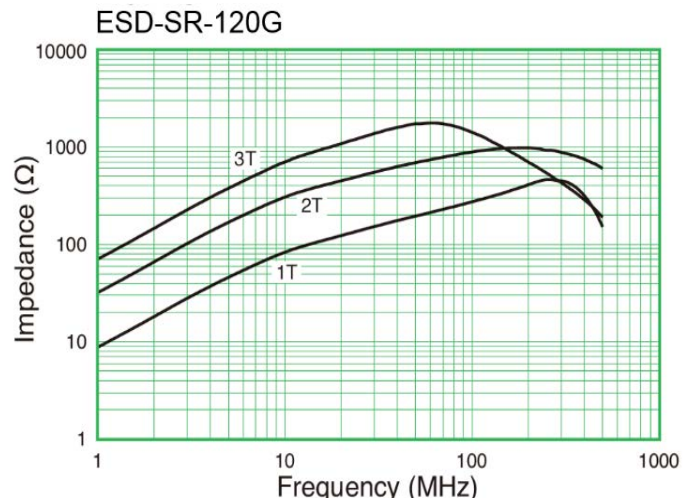
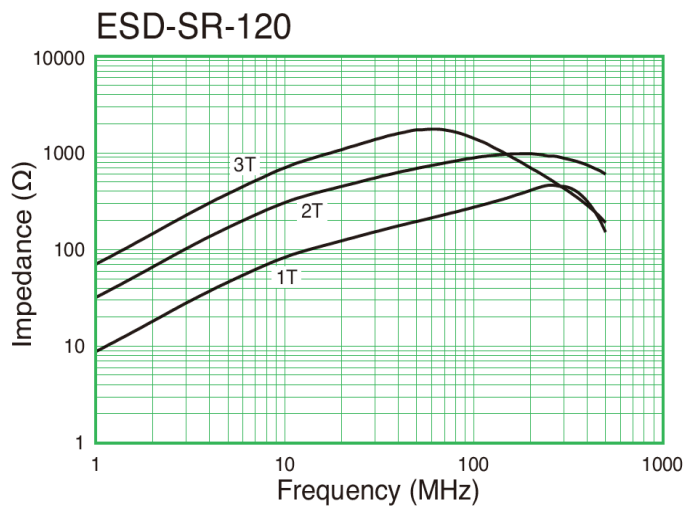
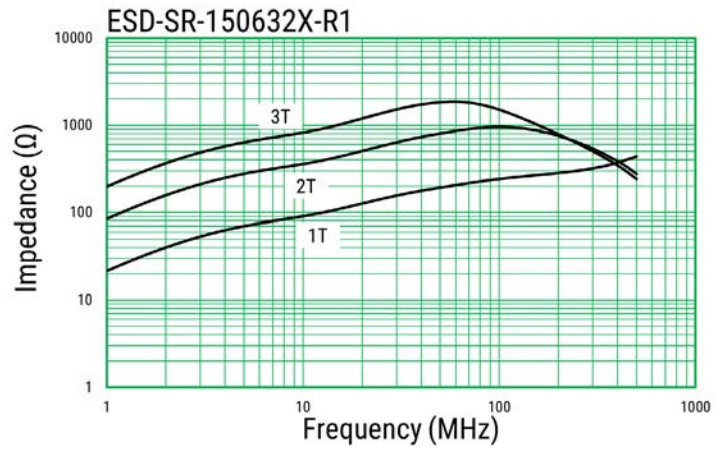
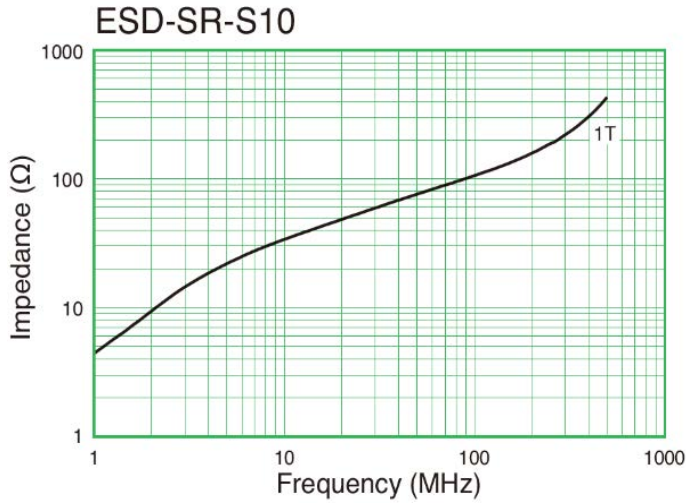

Impedance vs. Frequency cont.

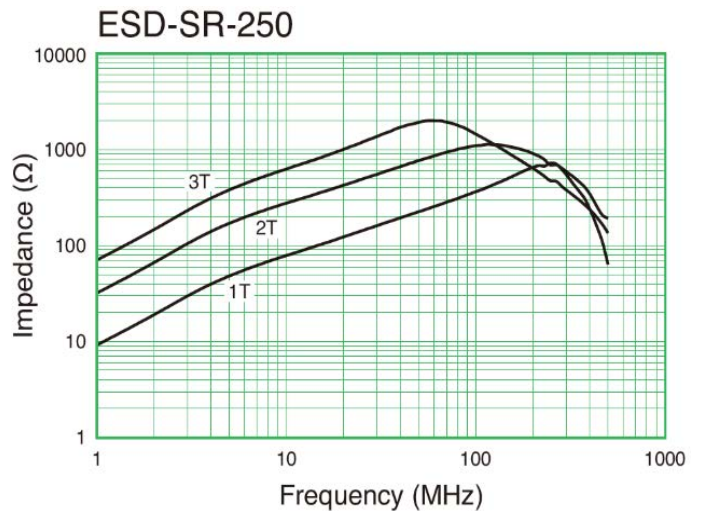
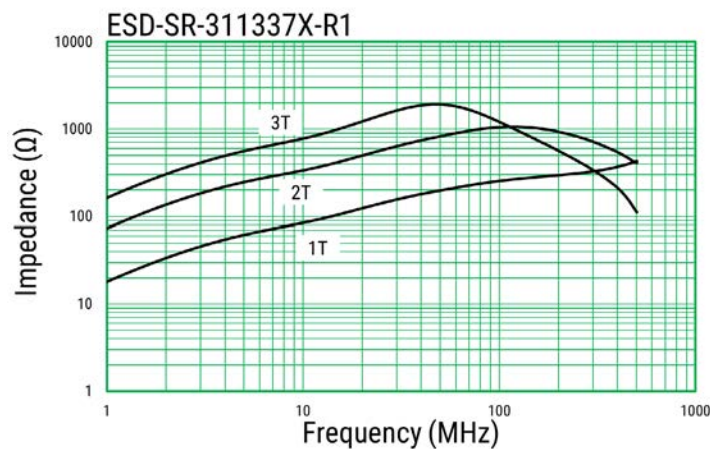
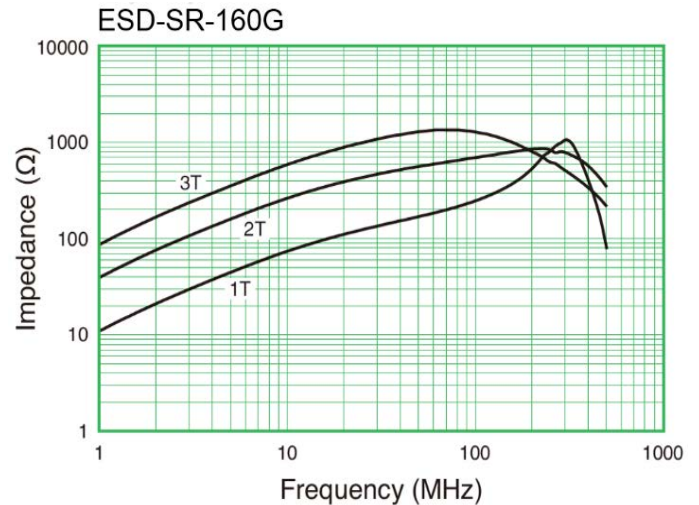
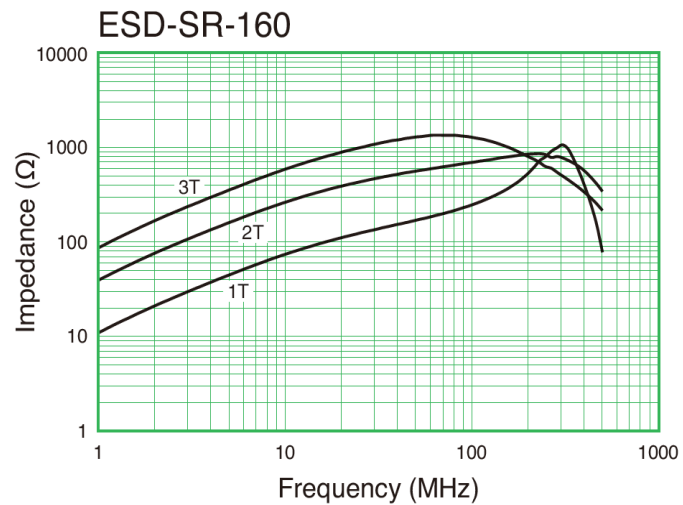
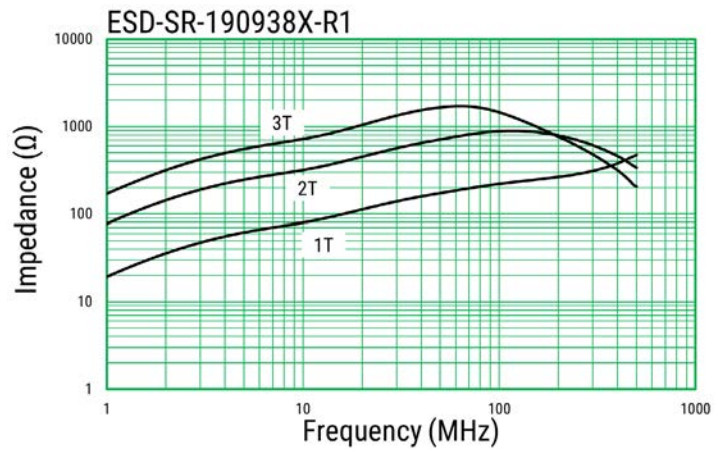
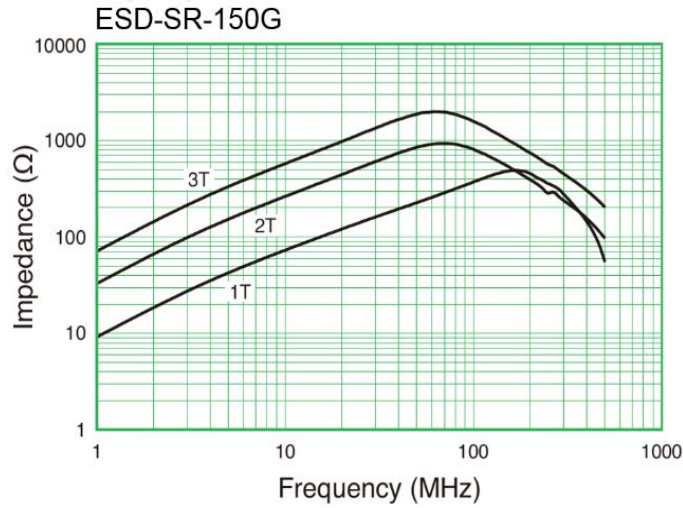

Impedance vs. Frequency cont.

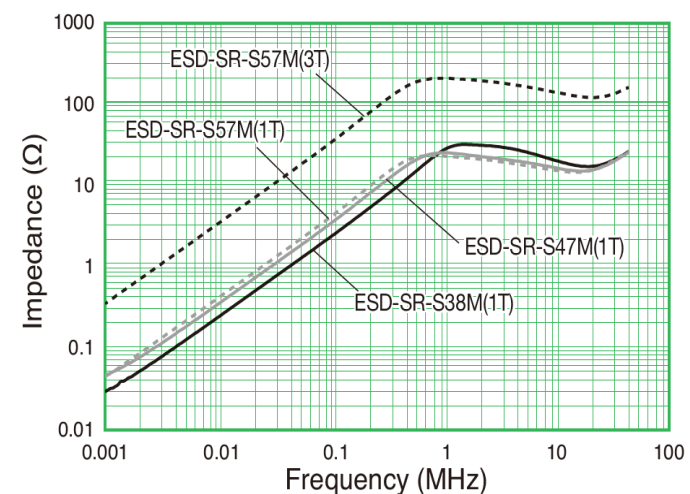
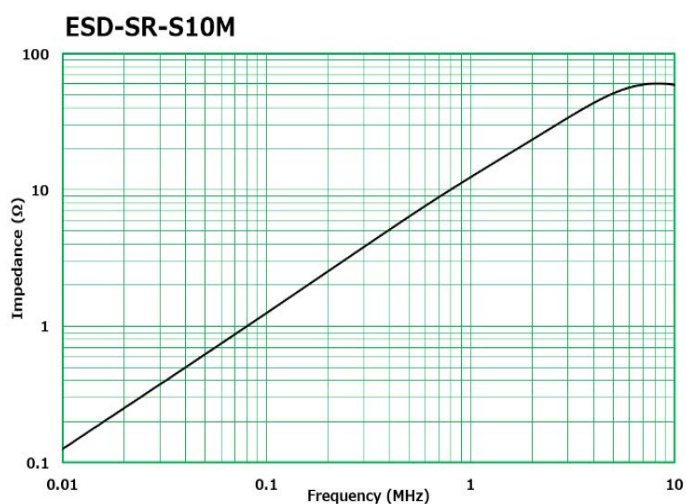
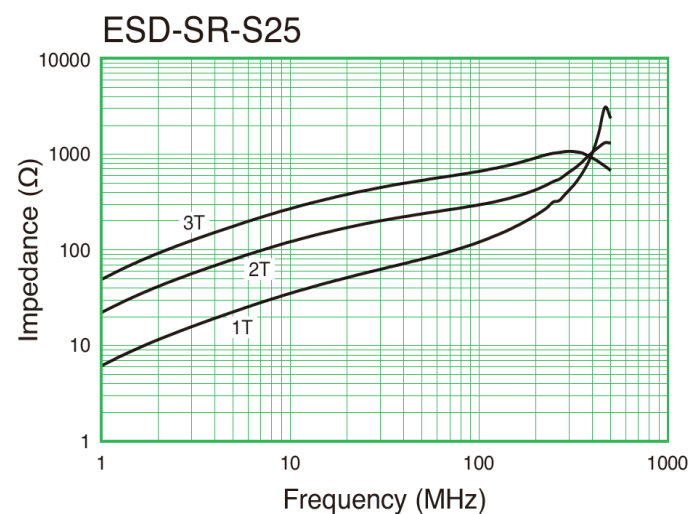
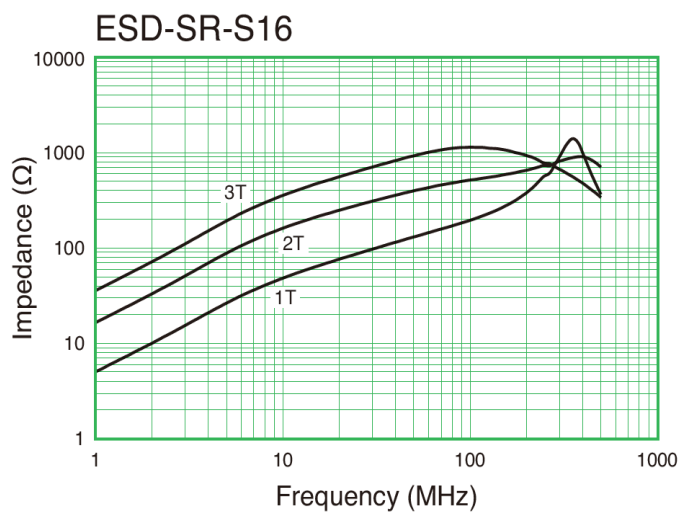
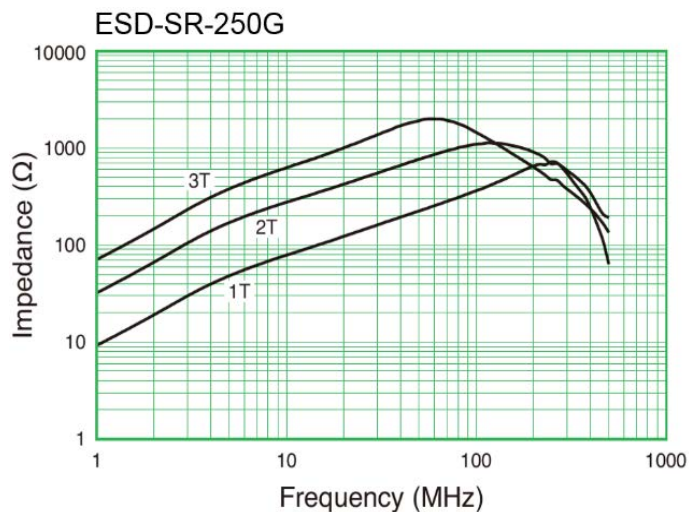

Packaging

Part Number	Packaging Type	Pieces per Box
ESD-SR-100	Tray	900
ESD-SR-100G		
ESD-SR-160620X-R1		
ESD-SR-110		
ESD-SR-110G		
ESD-SR-130527X-R1		
ESD-SR-S10		800
ESD-SR-120		700
ESD-SR-120G		
ESD-SR-150632X-R1		
ESD-SR-150		400
ESD-SR-150G		
ESD-SR-190736X-R1		
ESD-SR-160		
ESD-SR-160G		
ESD-SR-190938X-R1		
ESD-SR-250		60
ESD-SR-250G		
ESD-SR-311337X-R1		
ESD-SR-S16		280
ESD-SR-S25		200
ESD-SR-S10M		800
ESD-SR-S38M		72
ESD-SR-S47M		
ESD-SR-S57M		36

Handling Precautions

EMI Cores should be stored in normal working environments. While the EMI Cores themselves are quite robust in other environments, avoid exposure to high temperatures, high humidity, corrosive atmospheres and long term storage for case, snap-on and split types.

KEMET recommends that maximum storage temperature not exceed 40°C and maximum storage humidity not exceed 75% relative humidity. Atmospheres should be free of chlorine, sulfur and alkali bearing compounds. Avoid also storage near strong magnetic fields as this might magnetize the product.

Temperature fluctuations should be minimized to avoid condensation or cracks on the parts. Mechanical shocks can bring to cracks as well.

KEMET Electronics Corporation Sales Offices

For a complete list of our global sales offices, please visit www.kemet.com/sales.

Disclaimer

YAGEO Corporation and its affiliates do not recommend the use of commercial or automotive grade products for high reliability applications or manned space flight.

All product specifications, statements, information and data (collectively, the "Information") in this datasheet are subject to change. The customer is responsible for checking and verifying the extent to which the Information contained in this publication is applicable to an order at the time the order is placed. All Information given herein is believed to be accurate and reliable, but it is presented without guarantee, warranty, or responsibility of any kind, expressed or implied.

Statements of suitability for certain applications are based on KEMET Electronics Corporation's ("KEMET") knowledge of typical operating conditions for such applications, but are not intended to constitute – and KEMET specifically disclaims – any warranty concerning suitability for a specific customer application or use. The Information is intended for use only by customers who have the requisite experience and capability to determine the correct products for their application. Any technical advice inferred from this Information or otherwise provided by KEMET with reference to the use of KEMET's products is given gratis, and KEMET assumes no obligation or liability for the advice given or results obtained.

Although KEMET designs and manufactures its products to the most stringent quality and safety standards, given the current state of the art, isolated component failures may still occur. Accordingly, customer applications which require a high degree of reliability or safety should employ suitable designs or other safeguards (such as installation of protective circuitry or redundancies) in order to ensure that the failure of an electrical component does not result in a risk of personal injury or property damage.

Although all product-related warnings, cautions and notes must be observed, the customer should not assume that all safety measures are indicated or that other measures may not be required.

When providing KEMET products and technologies contained herein to other countries, the customer must abide by the procedures and provisions stipulated in all applicable export laws and regulations, including without limitation the International Traffic in Arms Regulations (ITAR), the US Export Administration Regulations (EAR) and the Japan Foreign Exchange and Foreign Trade Act.

KEMET is a registered trademark of KEMET Electronics Corporation.