

Price Index



Series E2-10

Special Features / Options



IPA Qualification Certificate:
Cleanroom test upon request



ESD Classification:
Electrically conductive ESD/
ATEX version upon request



Flammability Class
VDE 0304 IIC UL94 HB

Assembly Tips



Easy to assemble and disassemble

Usage Guidelines



- When long unsupported lengths and high additional loads are required with a small e-chain®
- For smooth, quiet operation due to small pitch
- If a large modular system in various designs is desired



- If a closed Energy Tube is required
➤ Series R07 “Zipper”
- If torsional rigidity is very important
➤ Series E2C-10 E2 Micro

Features & Benefits

- 1 Universal mounting bracket with strain relief option
- 2 Large, assembly friendly pins for long unsupported lengths
- 3 Very smooth contours ensure the best possible cable life
- 4 Non snap-open or snap-open in the inner or outer radius
- 5 Lightweight, low price
- 6 Square stop-dog system for large additional loads
- 7 Brake feature reduces noise

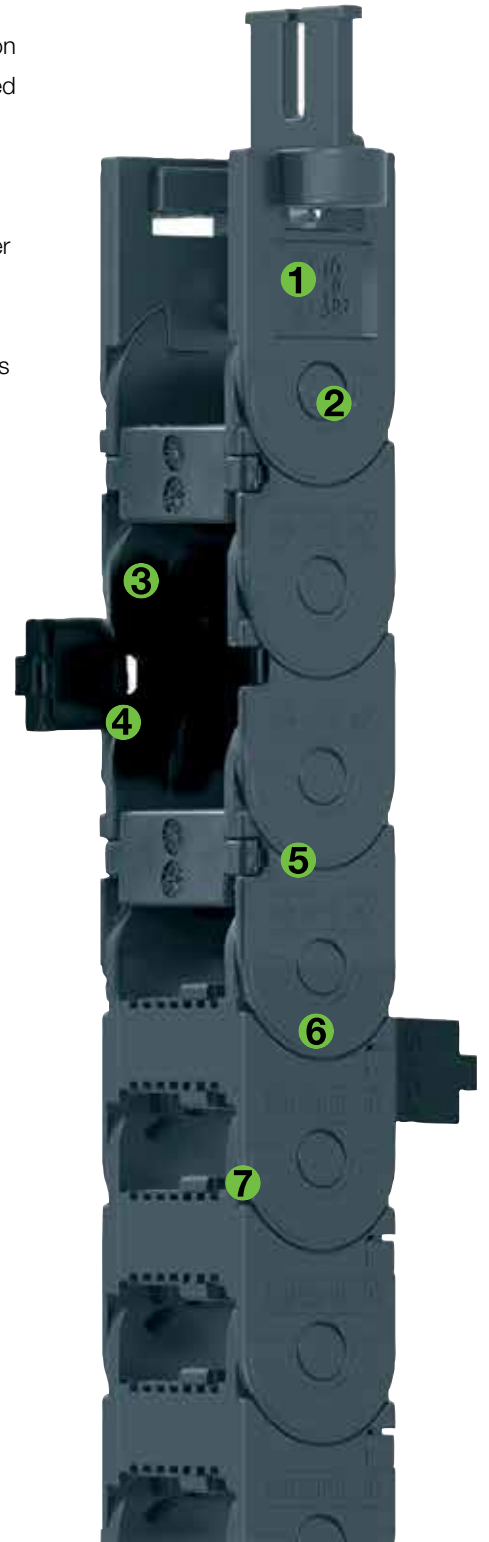

Order Example: Complete e-chain®

Please indicate chain length or number of links. Example:

3.28 ft (1 m) E2-10-20-038-0

e-chain®

1 Set E2-100-20-34PZ

Mounting Bracket

e-chain system® E2 Micro Series E2-10/E2i-10/E2C-10 Installation Dimensions



E2-10
E2i-10
E2C-10

Short travel, unsupported length

- FL_B = unsupported with permitted sag
 - FL_G = unsupported with straight upper run
- Further information ► Design, Chapter 1

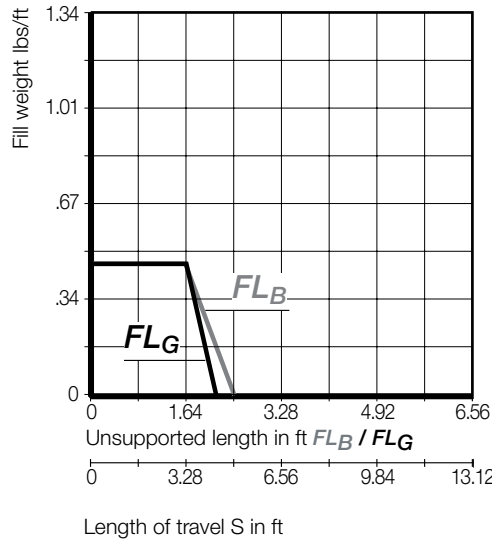
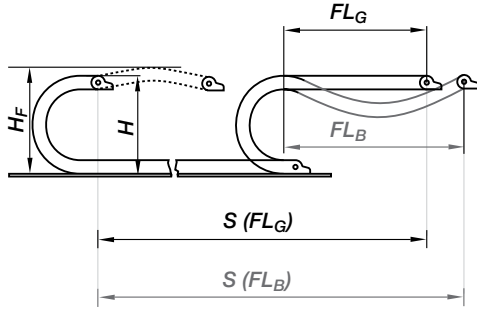

Short Travels - Unsupported



Unsupported e-chains® feature positive camber over short travels. This must be accounted for when specifying the clearance height. Please refer to **Installation dimensions** for further details.

Legend

- S = Length of travel
- R = Bending radius
- H = Nominal clearance height
- D = Overlength e-chain® radius in final position
- $K = \pi \cdot R + \text{safety buffer}$
- H_F = Required clearance height

*If the mounting bracket location is set lower

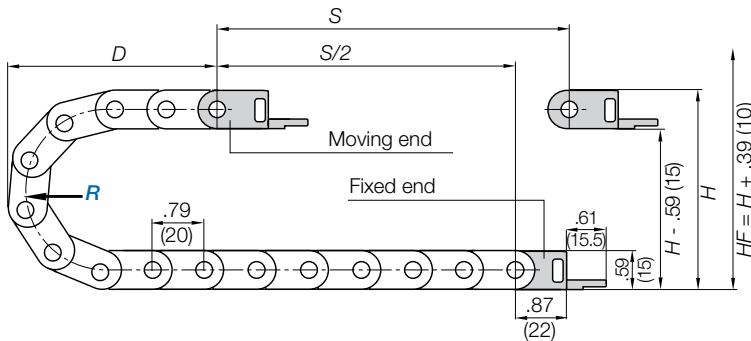

Pitch per link = .79" (20 mm)

Links per ft (m) = 15.24 (50)

For center mount applications:

Chain length = $\frac{S}{2} + K$

The required clearance height: $H_F = H + .39 \text{ in. (10 mm)}$ (with .13 lbs/ft (0.2 kg/m) fill weight). Please consult igus® if space is particularly restricted.

R	.71 (018)	1.10 (028)	1.50 (038)
H	2.01 (51)	2.80 (71)	3.58 (91)
D	2.20 (56)	2.60 (66)	2.99 (76)
K	3.94 (100)	5.12 (130)	6.30 (160)



PDF: igus.com/e-chain-pdfs
Product information: igus.com/e-chains



Speed / acceleration FL_G	max. 65.6 ft/s (20 m/s) / max. 656 ft/s ² (200 m/s ²)
Speed / acceleration FL_B	max. 9.84 ft/s (3 m/s) / max. 19.69 ft/s ² (6 m/s ²)
Gliding speed / acceleration (maximum)	max. 9.84 ft/s (3 m/s) / max. 32.8 ft/s ² (10 m/s ²)
Material - permitted temperature	igumid G / -40°F (-40°C) up to +248°F (+120° C)
Flammability Class, igumid G	VDE 0304 IIC UL94 HB

Technical Data



Details of material properties

► Chapter 1

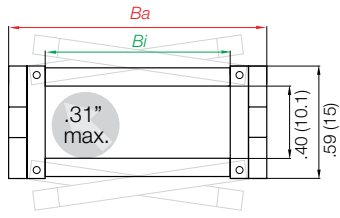

Series E2-10 - Snap-open along the outer radius from both sides



Part Number Structure



Color - Black
Bending radius
Width
Series

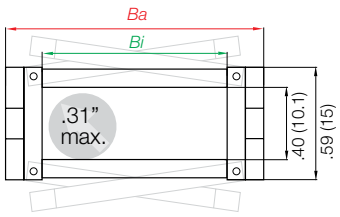

Series E2i-10 - Snap-open along the inner radius from both sides



Part Number Structure



Color - Black
Bending radius
Width
Series

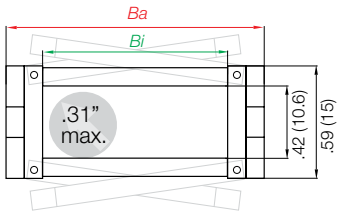

Series E2C-10 - One-piece, non snap-open



Part Number Structure



Color - Black
Bending radius
Width
Series

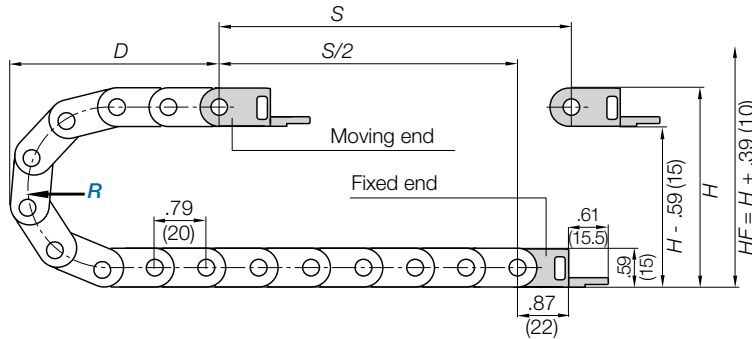

Supplement part number with required radius. Example: E2-10-20--0

Pitch: .79 in. (20 mm) per link links/ft (m) = 15.24 (50)

Snap-open along outer radius	Snap-open along inner radius	One-piece non snap-open		Bi in. (mm)	Ba in. (mm)	Weight		
						E2-10 lbs/ft (kg/m)	E2i-10 lbs/ft (kg/m)	E2C-10 lbs/ft (kg/m)
E2-10-06-	E2i-10-06-	E2C-10-06-	<input type="text" value="038"/> -0	.28 (6)	.53 (13.4)	≈ 0.087 (0.13)	≈ 0.087 (0.13)	≈ 0.094 (0.14)
E2-10-10-	E2i-10-10-	E2C-10-10-	<input type="text" value="038"/> -0	.39 (10)	.69 (17.4)	≈ 0.094 (0.14)	≈ 0.094 (0.14)	≈ 0.094 (0.14)
E2-10-16-	E2i-10-16-	E2C-10-16-	<input type="text" value="038"/> -0	.63 (16)	.92 (23.4)	≈ 0.107 (0.16)	≈ 0.107 (0.16)	≈ 0.107 (0.16)
E2-10-20-	E2i-10-20-	E2C-10-20-	<input type="text" value="038"/> -0	.79 (20)	1.08 (27.4)	≈ 0.114 (0.17)	≈ 0.114 (0.17)	≈ 0.114 (0.17)
E2-10-30-	E2i-10-30-	E2C-10-30-	<input type="text" value="038"/> -0	1.18 (30)	1.47 (37.4)	≈ 0.128 (0.19)	≈ 0.128 (0.19)	≈ 0.134 (0.20)
E2-10-40-	E2i-10-40-	E2C-10-40-	<input type="text" value="038"/> -0	1.57 (40)	1.87 (47.4)	≈ 0.148 (0.22)	≈ 0.148 (0.22)	≈ 0.154 (0.23)
E2-10-50-	E2i-10-50-	E2C-10-50-	<input type="text" value="038"/> -0	1.97 (50)	2.26 (57.4)	≈ 0.168 (0.25)	≈ 0.168 (0.25)	≈ 0.168 (0.25)

Choose from the radii below for all of the above sizes

Radius (mm) Example: E2-10-20--0

0=Standard color black.
For other colors see Chapter 1

	018	028	038
R	.71 (018)	1.10 (028)	1.50 (038)
H	2.01 (51)	2.80 (71)	3.58 (91)
D	2.20 (56)	2.60 (66)	2.99 (76)
K	3.94 (100)	5.12 (130)	6.30 (160)

e-chain system® E2 Micro
 Series E2-10/E2i-10/E2C-10
 Interior Separation



E2-10
 E2i-10
 E2C-10

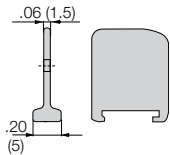
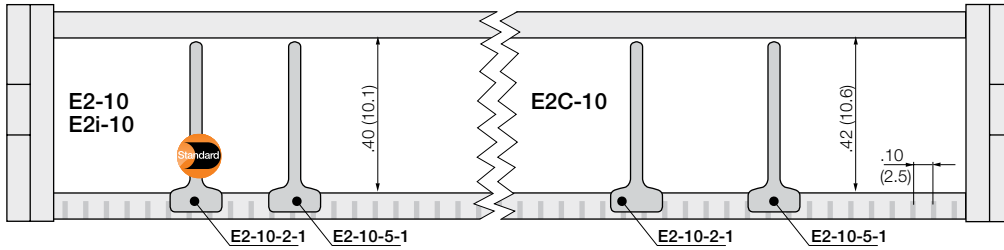

Separator

Unassembled	Part No. E2-10-2
Assembled	Part No. E2-10-2-1

- **Separator E2-10-2 Standard - for all applications**
 For a simple vertical subdivision on e-chains®. Separators can be arranged anywhere in the Energy cross section.

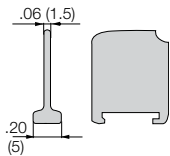

**Notch separator
 For notch crossbar**

Unassembled	Part No. E2-10-5
Assembled	Part No. E2-10-5-1

- **Notch separator E2-10-5 Locks safely in .10" (2.5 mm) increments**
 For exact positioning in e-chains®. Recommended for side-mounted applications.

PDF: igus.com/e-chain-pdfs
 Product information: igus.com/e-chains





Polymer, one-piece

- One-piece mounting bracket
- Corrosion resistant
- Available preassembled
- Inner and outer attachment possible
- Available with or without strain relief tiwrap plates

Moving end

- E2-100-...-3PZ two side pivoting
- E2-100-...-5PZ one side* pivoting
- E2-100-...-1PZ locking

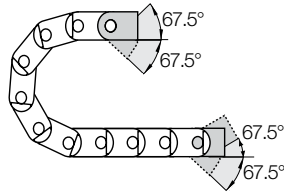

Fixed end

- E2-100-...-4PZ two side pivoting
- E2-100-...-6PZ one side* pivoting
- E2-100-...-2PZ locking

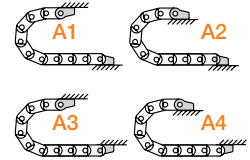

Possible installation configurations -

Part Number Structure

E2-100- 20- 34 PZ

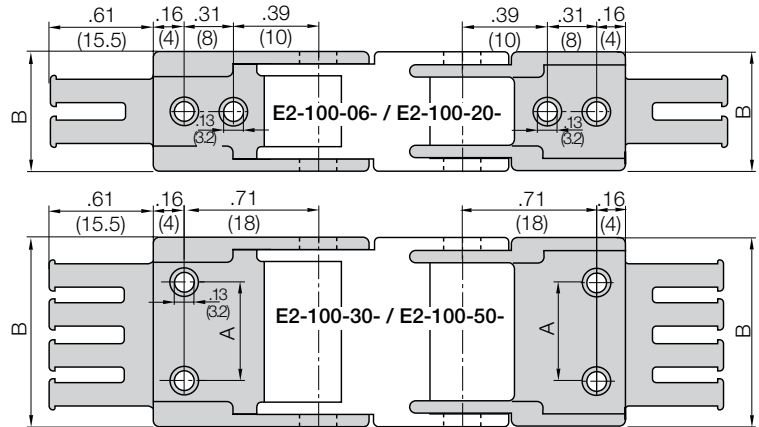
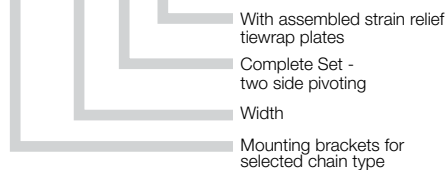

Full set, for both ends:

E2-100- [20-] [34] Full set, each part with pin/bore

Single-part order:

- E2-100- [20-] [3] Mounting bracket with bore
- E2-100- [20-] [4] Mounting bracket with pin

E2-100-06-12 - E2-100-20-12: Center bores only
E2-100-30-12 - E2-100-64-12: Outer bores only

Chain Width	Part No. full set with tiwrap plate two side pivoting	Part No. full set with tiwrap plate one side* pivoting	Part No. full set with tiwrap plate locking	Dimension A in. (mm)	Dimension B in. (mm)	Number of Teeth
-06	E2-100-06-34PZ	E2-100-06-56PZ	E2-100-06-12PZ	—	.53 (13.4)	1
-10	E2-100-10-34PZ	E2-100-10-56PZ	E2-100-10-12PZ	—	.69 (17.4)	1
-16	E2-100-16-34PZ	E2-100-16-56PZ	E2-100-16-12PZ	—	.92 (23.4)	2
-20	E2-100-20-34PZ	E2-100-20-56PZ	E2-100-20-12PZ	—	1.08 (27.4)	2
-30	E2-100-30-34PZ	E2-100-30-56PZ	E2-100-30-12PZ	.87 (22)	1.47 (37.4)	3
-40	E2-100-40-34PZ	E2-100-40-56PZ	E2-100-40-12PZ	1.26 (32)	1.87 (47.4)	4
-50	E2-100-50-34PZ	E2-100-50-56PZ	E2-100-50-12PZ	1.65 (42)	2.26 (57.4)	5

*One-side pivoting: Pivot angle = Bending radius.

One side pivoting only to the inner radius - whether mounted to A1 or A4

Additional Accessories



Quick flange- the quick flange can be clipped-in laterally in all mounting brackets. Housing for hexagonal nut or M3 socket head screws M3.

Single:

Part no. E2-150-QF

Includes mounting bracket:

Part No. E2-100-20-34PZQF

