



HELUKABEL®



 Edition 21

CABLE ACCESSORIES

Data sheets are as of date of print.
You can find the latest versions online
according to this principle:
www.helukabel.com/10001en*

* Instead of 10001 please insert the wanted part number.

■ EDITORIAL

Whether connecting, fastening or protecting – only with a screened connection equipment cables will fulfil its function reliable and especially permanent. For this reason we are offering the appropriate accessories for our cables and wires. Now the time has come: The new catalogue is hot off the press. The new "Cable accessories Edition 21" catalogue has not just be given a new facelift - also the content was revised. We expanded the catalogue with some more products: The new cable gland HELUTOP-HT-AIR-PA prevents the formation of condensation, for instance in switching cabinets beeing exposed to changing temperatures (see p. 185). The HELUTOP HT-Clean, a cable gland with blank surface used in the hygiene sector has very good cleaning properties and is also available as EMC version (see p. 176). All accessories in our product range comply with the latest guidelines and standards. Furthermore, you will find a completely revised cable lug program (from p. 379). All accessories are available from stock in our fully automated small parts warehouse with more than 36,000 bin locations – guided by the motto „Everything from a single source“.



Helmut Luksch,
CEO of HELUKABEL® GmbH



■ HELUKABEL® AT A GLANCE

SOLID

- Family enterprise since 1978

QUALITY-MINDED AND ECOLOGY-MINDED

- ISO 9001 & 14001 & 50001
- Energy supplied by the firm's own solar and bio-gas plant

HIDDEN CHAMPION

- 476 million Euro turnover
- 1200 employees

GLOBAL

- 48 locations in 29 countries

PRODUCTION

- 6 Manufacturing and assembly locations worldwide

LOGISTICS

- 33,000 products in stock, from the cable gland to the 2.40 m cable drum
- 24 h delivery service
- State-of-the-art logistics concept

PRODUCTS

Cables, wires, and cable accessories - a single source for industry and infrastructure

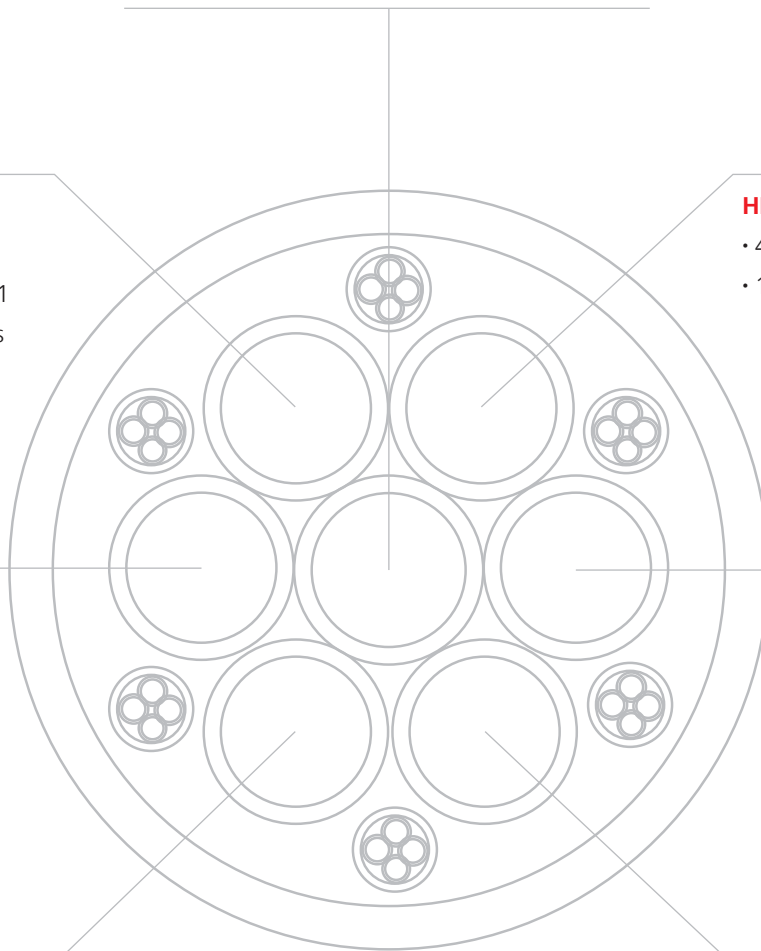

■ TABLE OF CONTENTS

LEAD TEXT	1
Research & Development.....	4
Production.....	6
Logistics Center.....	8
Our values	10
Our branded products.....	12
Robotec Systems	14
Kabelmat Wickeltechnik.....	16
Always close to you - 48 locations in 29 countries	18
Chapter overview	20
CABLE GLANDS	22
CABLE PROTECTION TUBE SYSTEMS	188
ENERGY DRAG CHAINS	284
INSULATED, SHRINK, BRAIDED, AND TEMPERATURE PROTECTION TUBES	300
ENDCAPS & CORE END SLEEVES	326
BUNDLING, BINDING, AND FASTENING	342
IDENTIFICATION & MARKING	362
PV-MALE & FEMALE CABLE COUPLERS	376
CORE END SLEEVES AND CABLE LUGS	378
TOOLS	424
HELUTEC® SIGNAL AND POWER CONNECTORS	486
TECHNICAL INFORMATION	500
General notes	502
Selection tables	511
Technical explanations	520
Type index and key word index	525
Part number index	529

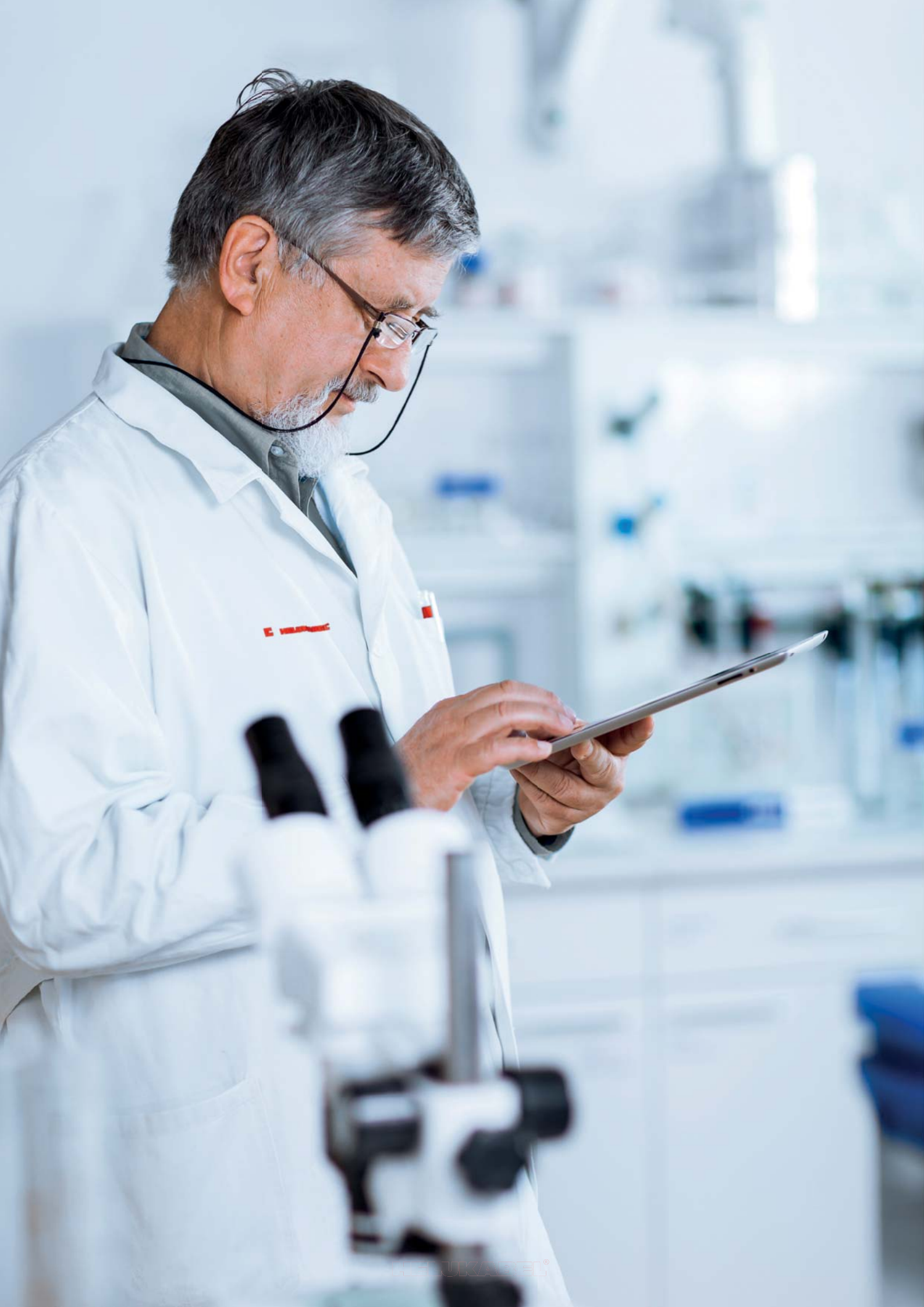

■ RESEARCH & DEVELOPMENT

We develop optimal, customized cable solutions for our customers.



Torsion test

Our test facilities:

- Test systems for bending and torsion requirements
- Drag chain test systems with movement distances from 1 m, 3 m, 5 m, 6 m, 18 m, and 40 m
- Fire testing systems
- Abrasion testing systems
- Torsion test tower for wind turbines
- Aging ovens in accordance with UL, VDE, CSA, HAR, TÜV, CCC

Research and development are the foundation of our work and are an important engine for growth. In interdisciplinary teams we continuously develop our products and seek to enhance them for multiple applications. Moreover, we rely on customer feedback as well as cooperation with regional colleges and research institutes.

The materials that will be used are an important starting point of our work. In this regard, we place as much emphasis on searching for and utilizing new materials as we do on manufacturing our plastic mixtures (granulates) ourselves, in order to enhance mechanical properties, such as oil resistance, temperature range or chemical compatibility. Furthermore, we are capable of pulling a majority of our copper ourselves, and thus ensure a uniform, high quality relative to properties and workmanship.

By continuously optimizing our manufacturing processes and procedures, we have become more efficient and economical, and yet we are still able to take the complex requirements of a wide variety of applications (such as cables for industrial robots or for applications under clean-room conditions) into account.

A crucial stage in the development process of our products is the work done in our Test Centre. For example, cables suitable for drag chain implementation can be tested with acceleration up to 10 G. Temperature ranges from -50°C to $+250^{\circ}\text{C}$ are simulated in a special climate device so that drag chain cables can be tested for series production readiness before they are installed in applications like refrigerated warehouses or steel mills.



Drag chain test system



■ PRODUCTION

We specialize in the production of high-quality cables and wires.

In our two German plants, using the latest production methods, each year we manufacture approximately one million conductor kilometers (= 25 times around the world). More than 300 qualified employees are specialized in the production of high-quality standard and specialty cables. Through use of the latest materials and collaboration with international test institutes, we drive innovation in the areas of automation, data technology, building system technology, and renewable energy.

Since 2014, in a 7,000 m² facility in the Chinese city of Taicang (approx. 50 km northwest of Shanghai) HELUKABEL® has been producing cable and wires, primarily for the Asian region. As in the German plants, the focus here is also on high-quality, flexible and highly flexible cables and wires that are manufactured in accordance with Chinese and international standards. The use of flexible manufacturing cells enable short delivery times.



Braiding machine

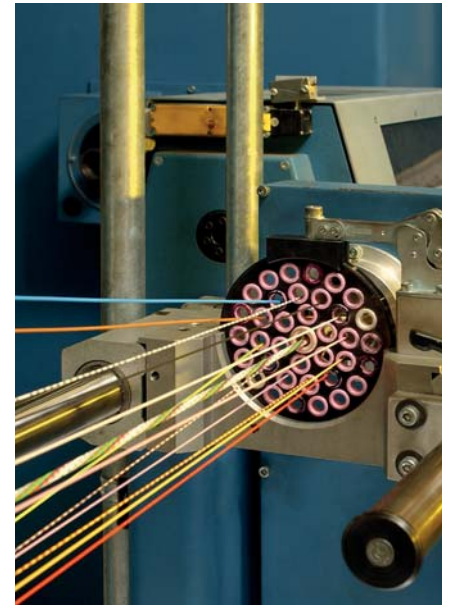

Stranding machine

Our production in numbers:

- 40 000 m² production area
- 23 extruder systems
- 19 stranding machines
- 50 braiding machines
- Cables & wires from 0.05 to 1000 mm²
- Manufacturing in accordance with: VDE, EAC (GOST-R), UL, CSA, HAR, CCC, Germanischer Lloyd, TÜV or customer specification



■ LOGISTICS

Cable industry logistics redefined.

INDUSTRIAL CABLE

Our logistics center – Hemmingen/Stuttgart

- 40,500 Euro-pallet racks with max. reel weight of 1,500 kg; 16 aisles with 16 storage and retrieval devices
- 36,800 bin locations in the automatic small parts warehouse with a capacity of 1,000 bins per hour
- 670 storage spaces in the heavy load warehouse with max. reel weight of 4,000 kg and 2.20 m diameter
- 2 km conveyor line for pallets
- Conveyor connects direct to the cable-cutting machines
- Manual processes reduced to merely packing

INFRASTRUCTURE CABLES

Our logistics center – Neuenhagen/Berlin

- 11,000 cable reels in stock
- Automatic processing of reels up to 2.80 m diameter and 10 t
- 10 rewinding machines
- Cut to length with state-of-the-art 1,200 mm² cutting tools
- 24-hr delivery is possible

At its corporate headquarters in the Swabian town of Hemmingen, HELUKABEL® operates Europe's largest distribution centre for cables and wires. This is where a majority of the more than 33,000 products are housed in a 160,000 m² storage area. Through the use of state-of-the-art conveyor and control technology, more than 1,000 orders can be picked and shipped daily to destinations around the world.



Heavy-load length-cutting facility

Neuenhagen/Berlin is the central warehouse location for underground cable, medium-voltage cable, and other infrastructure cables. Storage capacities of more than 5,000 m² in the warehouse and 50,000 m² outdoors enable fast deliveries of cable, configured from 1 – 30 kV, to construction sites and major projects. The patented heavy load length-cutting machines with more than 10 tons of load capacity are the largest of their type in Germany.

The new logistics centre at the Taicang (China) production facility serves as a product distribution hub for the Asian region, and offers incredible advantages, particularly for servicing time-critical and volume-critical major projects.



Small parts warehouse



■ OUR VALUES

Success through quality and innovation

HELUKABEL® GmbH is an independent company that develops, manufactures and sells cables, wires and accessories. In an environment of increasing expectations from both customers and society, the growth strategy of HELUKABEL® GmbH is based on consistent target orientation, high adaptability and continuous development of its management system. Our goal is to achieve sustainable business success through the confidence and satisfaction of our customers and society. As a result, HELUKABEL® GmbH places great emphasis on

the quality and environmental impact of its processes and products, the efficient use of resources and energy, and on satisfying legal and regulatory requirements. This is why HELUKABEL® GmbH developed and implemented an integrated management system for quality, environmental impact and energy performance based on the DIN EN ISO 9001, DIN EN ISO 14001 and DIN EN ISO 50001 standards. Our high standards are reflected in the following criteria:



The integrated management system for quality, environmental impact and energy performance reinforces HELUKABEL®'s success as a company and documents our work processes, which all employees and managers are bound to implement in accordance with what is prescribed in the management handbook.



■ OUR BRANDED PRODUCTS

Cables & Wires

- BIOFLEX-500® bio-oil resistant cables
- CLEANFLEX® cleanroom data and control cables
- DATAFLAMM® data and computer cables, halogen-free
- DATAPUR-C® data and computer cables
- GALVANICABLE® high-voltage cathode cable
- HELUFLON® heat-resistant cables
- HELUTHERM® heat-resistant cables
- HELUTRAIN® train cables
- HELUTRUCK® vehicle cables / truck cables
- HELUWIND® wind power cables
- KOMPOFLEX® microbe-resistant cables
- KOMPOSPEED® bio-oil resistant drag chain cables
- LIFT-TRAGO® elevator control cables
- MEGAFLEX® flexible control cables, halogen-free (UL/CSA)
- MULTIFLEX 512® drag chain cables PUR
- MULTISPEED® drag chain cables
- NANOFLEX® PUR special control and data cables
- ROBOFLEX® robot cables
- SENSORFLEX® sensor cables
- SHIPFLEX® drag chain cables
- SOLARFLEX® photovoltaic cables
- SUPER-PAAR-TRONIC-C-PUR® drag chain cables, halogen-free
- SUPERTRONIC® drag chain cables
- THERMFLEX® heat-resistant cables
- TOPFLEX® servo, encoder, and motor cables
- TOPSERV® servo, encoder, and motor cables
- TRAYCONTROL® exposed run cable
- TROMMPUR® easy-to-wind cables
- UNIPUR® PUR, flexible control cables

Cable accessories

- HELUCHAIN® drag chain product line
- HELUTEK® industrial connector series
- HELUTOP® cable gland product line

Data, network & bus technology

- HELUCOM® fiber optic cables
- HELUKAT® fiber optic connection technology
- HELUKAT® copper data cable
- HELUKAT® copper connection technology

Media technology

- HELUEVENT® high-power cable for TV studios
- HELULIGHT® cables for lighting control systems
- HELUSOUND® audio cable

■ ALWAYS CLOSE TO YOU - 48 LOCATIONS IN 29 COUNTRIES

HELUKABEL® GmbH Deutschland 

Headquarters

Dieselstraße 8-12
71282 Hemmingen / Stuttgart
Phone +49 7150 9209-0
Fax +49 7150 81786
info@helukabel.de

Sales office & warehouse - Berlin

Zum Mühlenfließ 1
15366 Neuenhagen / Berlin
Phone +49 3342 2397-0
Fax +49 3342 80033
info@helukabel.de

Sales office & warehouse - Pleiße

Eichelbergstraße 7
09212 Limbach-Oberfrohna
Phone: +49 3722 6086-0
Fax +49 3722 6086-420
info@helukabel.de

Sales office - North

Viktoriastraße 2
25524 Itzehoe
Phone +49 4821 40394-0
Fax +49 4821 40394-29
info@helukabel.de

Sales office - Rhein-Ruhr

Centroallee 261
46047 Oberhausen
Phone +49 208 882320-0
Fax +49 208 882320-10
info@helukabel.de

Development & Production

Neuseser Weg 11
91575 Windsbach
Phone +49 9871 6793-0
Fax +49 9871 1055
info@helukabel.de

Robotec Systems GmbH - Germany

Theodor-Heuss-Str. 99
47167 Duisburg
Phone +49 203 935424-0
Fax +49 203 935424-10
info@robotec-systems.de
www.robotec-systems.de

Kabelmat Wickeltechnik GmbH - Germany

Steinbuckelweg 25
72293 Glatten
Phone +49 (0)7443 9670-0
Fax +49 (0)7443 9670-39
kabelmat@kabelmat.com
www.kabelmat.de

HELUKABEL® international locations

 **HELUKABEL® Belgium**
Phone: +32 24 81 00 20
info@helukabel.be

 **HELUKABEL® Mexico**
Phone: +49 7150 9209-772
info@helukabel.mx

 **HELUKABEL® Switzerland**
Phone: +41 56 4181515
contact@helukabel.ch

 **HELUKABEL® Brazil**
Phone: +49 7150 9209-675
info@helukabel.com.br

 **HELUKABEL® Netherlands**
Phone: +31 495 499 049
info@helukabel.nl

 **HELUKABEL® Czech Republic**
Phone: +42 0312 672 620
prodej@helukabel.cz

 **HELUKABEL® Bulgaria**
Phone: +359 888189638
info@helukabel.bg

 **HELUKABEL® Austria**
Phone: +43 7224 90555 0
office@helukabel.at

 **HELUKABEL® Thailand**
Phone: +66 2927 3570 3
info@helukabel.co.th

 **HELUKABEL® China**
Phone: +86 21 58693999
info@helukabel.com.cn

 **HELUKABEL® Poland**
Phone: +48 46 85 80 10 0
biuro@helukabel.pl

 **HELUKABEL® Turkey**
Phone: +90 212 502 41 95
info@helukabel.com.tr

 **HELUKABEL® France**
Phone: +33 389 627562
info@helukabel.fr

 **HELUKABEL® Portugal**
Phone: +351 239 099596
geral@helukabel.pt

 **HELUKABEL® UK**
Phone: +44 151 345 0808
info@helukabel.co.uk

 **HELUKABEL® India**
Phone: +91 22 25 18 58 41
info@helukabel.in

 **HELUKABEL® Russia**
Phone: +7 812 449 10 60
info@helukabel.ru

 **HELUKABEL® USA**
Phone: +1 847 930 5118
sales@helukabel.com

 **HELUKABEL® Indonesia**
Phone: +62 213 848872
sales@helukabel.co.id

 **HELUKABEL® Singapore**
Phone: +65 65 54 6170
sales@helukabel.com.sg

 **HELUKABEL® UAE**
Phone: +971 48 87 95 94
info@helukabel.ae

 **HELUKABEL® Italy**
Phone: +39 039 6081503
info@helukabel.it

 **HELUKABEL® South Africa**
Phone: +27 11 462 8752
info@helukabel.co.za

 **HELUKABEL® Vietnam**
Phone: +84 8 38443698
info@helukabel.com.vn

 **HELUKABEL® Canada**
Phone: +1 289 444 5040
sales@helukabel.ca

 **HELUKABEL® South Korea**
Phone: +82 51 9728646
info@helukabel.co.kr

 **HELUKABEL® Malaysia**
Phone: +603 7885 8724
sales@helukabel.com.my

 **HELUKABEL® Sweden**
Phone: +46 8 55 77 4280
info@helukabel.se

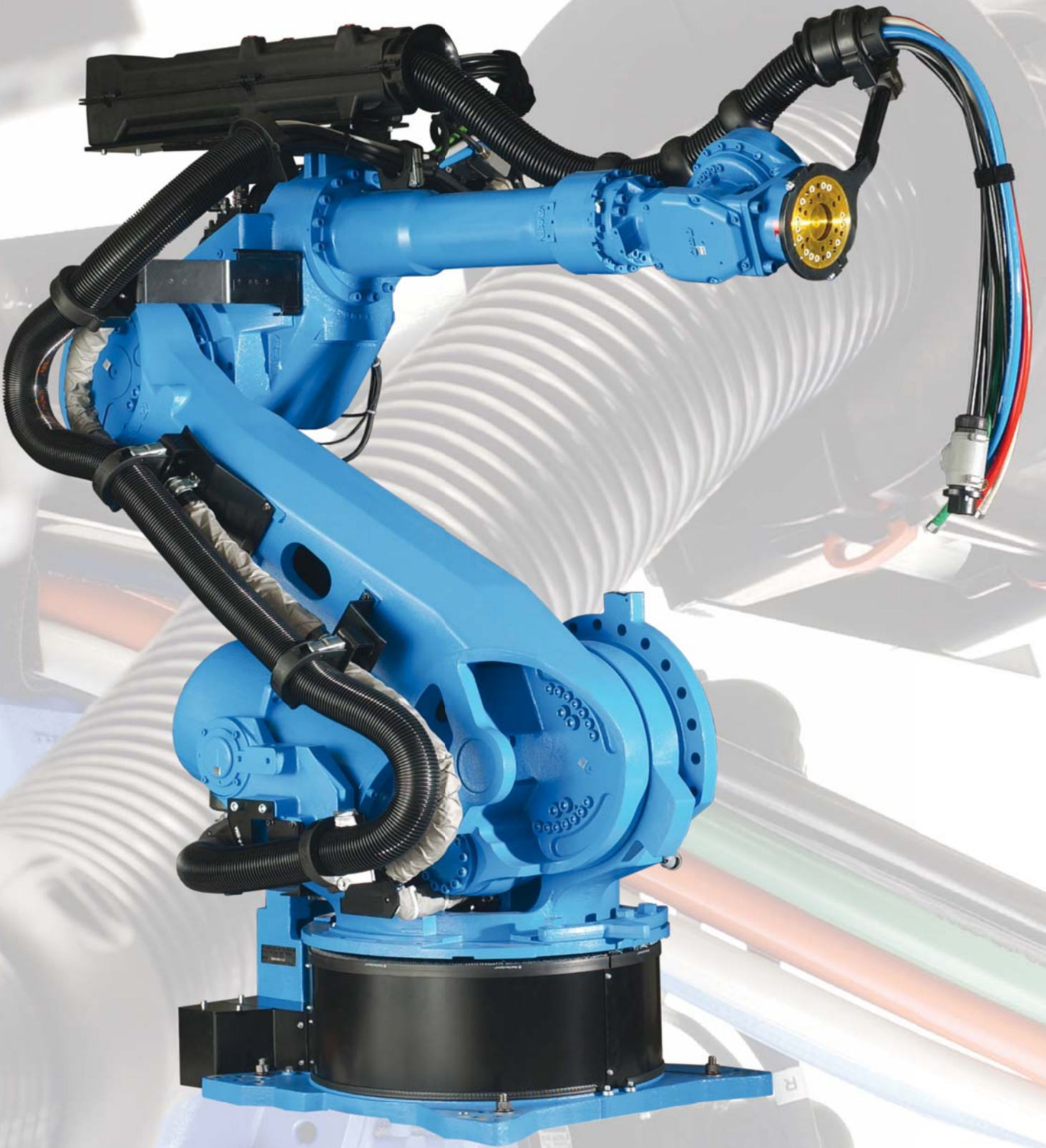

■ ROBOTEC SYSTEMS - COMPETENCE IN EVERYTHING RELATED TO THE ROBOT

Since its founding in 1998, Robotec Systems GmbH headquartered in Kamp-Lintfort, Germany has become one of the leading European companies for robot hose packages and the associated fastening systems as well as for special robot cables, cable assemblies, power screwdriver technology, controllers for measurement instrumentation, and media systems such as air hoses and water hoses. The company has been a 100% subsidiary of HELUKABEL® GmbH since July 2012. Robotec Systems develops tailored energy-supply systems that are pre-assembled

and ready to install. From the development of different solution concepts to prototyping, to final installation and onsite service, Robotec is a single source for all services.

Through the use of first-class components, as well as superstructures and material compositions tailored for the respective application the highest level of reliability and productivity is achieved.

Robotec's products are used in applications, such as spot welding, laser welding and inert gas welding, robot handling systems and tool changing systems.



Concept

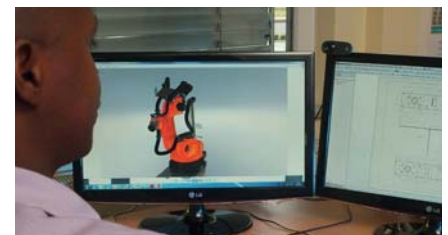

Development



Prototyping



Installation/optimization



Documentation



Repair/maintenance

Our components:

- Fastening elements & accessories
- Pivot bearings
- Spring clamps
- Protector / impact protection
- Trumpet and accessories
- Precision pipes
- Self-fastening hoses and accessories
- Cable protection hose
- Attachment parts
- Primary cables
- Control cables
- Cables for bus systems
- Pre-assembled special cables

Robotec Systems GmbH

Theodor-Heuss-Str. 99
47167 Duisburg
Phone +49 203 935424-0
Fax +49 203 935424-10
info@robotec-systems.de
www.robotec-systems.de



kabelmat
WICKELTECHNIK

■ KABELMAT WICKELTECHNIK GMBH

Kabelmat Wickeltechnik GmbH's history goes back to the 1960s and for a long time, the company has been among the market leaders for winding systems for the cable & wire industry and/or processing.

Customers include manufacturers, retailers, and processors of cables and wires, as well as cable assemblers, electricians, machine manufacturing companies, and many more.

The product range includes virtually all devices and machines for storing, winding, and cutting cables and wires, wire rope, tubes, hoses, and profiles.

Winding from drums and onto drums, as well as from drums to rings are among the tasks that are executed efficiently worldwide with the Kabelmat products.

We would be pleased to show you our products in our show-room. You are cordially invited to visit us at our facility.

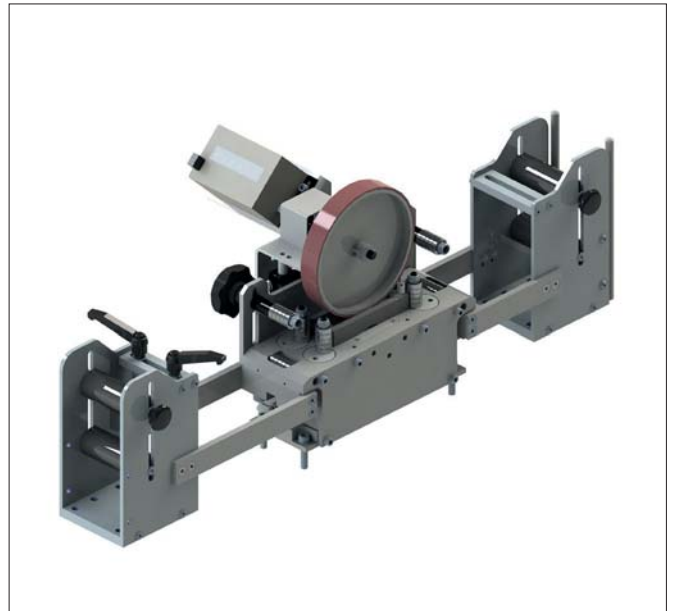

MESSBOI[®] 40

We offer:

- Manual winding technology
- Automatic winding technology
- Measuring technology
- Storage technology

Our services:

- Project planning & engineering
- Manufacturing and final assembly
- Service & maintenance

Kabelmat Wickeltechnik GmbH

Steinbuckelweg 25
72293 Glatten
Phone 07443 9670-0
Fax 07443 9670-39
kabelmat@kabelmat.com

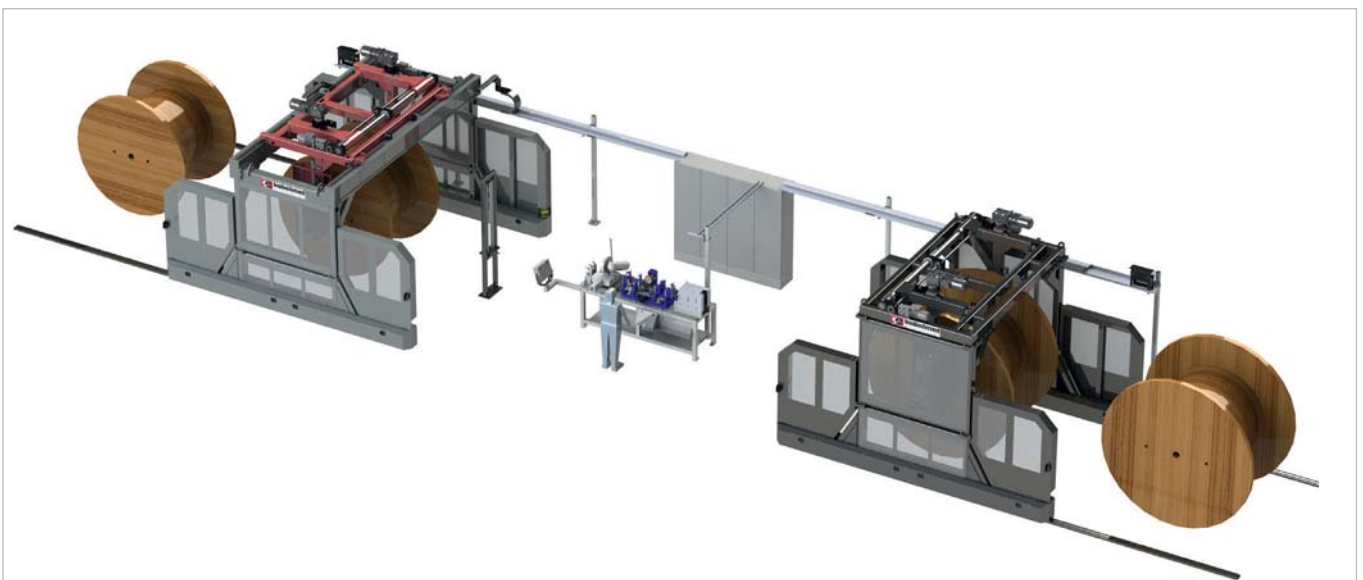

PORTROL[®] 2600 - 3000



■ CHAPTER OVERVIEW



Cable glands

p. 22 - 187

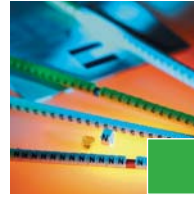

Identification & marking

p. 362 - 375



Cable protection tube systems

p. 188 - 283

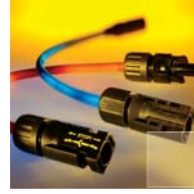

PV-male & female cable couplers

p. 376 - 377



Energy drag chains

p. 284 - 299



Core end sleeves and cable lugs

p. 378 - 423



Insulated, shrink braided, and temperature protection tubes

p. 300 - 325



Tools

p. 424 - 485



End caps & core end sleeves

p. 326 - 341



HELUTEC® signal connectors & power connectors

p. 486 - 499

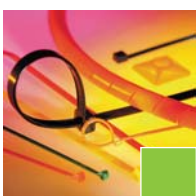

Bundling, binding, and fastening

p. 342 - 361



Technical information

p. 500 - 552



HELUTOP HT

HSK-PVDF

HELUTOP MS-EP4

KVA-XXL-MS

HELUTOP HT-Clean

OVERVIEW CABLE GLANDS

Plastic cable glands for standard applications

Series	Range	Item	Page
Seal with clamping plates			
HELUTOP® HT	Standard	HELUTOP® HT	28
		HELUTOP® HT-BS	30
	Dust protection / Sealing	HELUTOP® Protection tab	31
		HELUTOP® HT-MFDE	32
		Sealing plugs	33
		HELUTOP® HT-K	34
		HSK-METRIC-A-P	35
HSK	Standard	HSK	36
		HSK-L	39
	Long thread	HSK-B	41
	Kink protection	HSK-WI	42
	Elbow gland		
Seal with insert			
UNI-DICHT	Standard	UNI-DICHT-PA	43
		UNI-DICHT-MFD-PA	45
	Pre-assembled multiple sealing insert	UNI-DICHT-VK-PA	47
		UNI-DICHT sealing insert closed	48
	Gland body	UNI-DICHT sealing insert standard	49
		UNI-DICHT sealing insert/ Gland body classification	51
	Sealing inserts	UNI-DICHT MFDE Multiple sealing insert	52
		UNI-DICHT-ASI-PA	54
		UNI-DICHT sealing insert for ASI-Bus cable	55
		For ASI-Bus cable	
	Conventional design		
Cable gland according to DIN	STK-PA	56	
	STK-PA with incision sealing ring	57	
	STK-F	58	
	WN	59	
Flat cable gland			
	Self-sealing grommet		
Thread adapter			
Adapters	Adapter-PA	60	
	EW-PA	61	
	EW-PA	62	
Extenders			
Reducers			
Accessories / Parts			
Lock nut	KMK-PA-MB	64	
	KMK-PA-OB	65	
Screw plug	VSK-PA	66	
	O-ring	67	
Reinforced wall sealing	AGDR-PE	68	
	BL-H	69	
Dust protection / Sealing	BL-W	70	
	Incision sealing ring	71	
Sealing insert			

Brass cable glands for standard applications

Series	Range	Item	Page
Seal with clamping plates			
HELUTOP® HT	Standard	HELUTOP® HT-MS cable gland	74
	Dust protection / Sealing	HELUTOP® Multiple sealing insert / lock bolts	76
HSK	Standard	HSK-MS	77
	Long thread	HSK-MS-L	79
	Kink protection	HSK-MS-B	80
Seal with insert			
UNI-DICHT	Standard	UNI-DICHT-MS	81
	Pre-assembled multiple sealing insert	UNI-DICHT-MFD-MS	83
	Gland body	UNI-DICHT-VK-MS	85
	Sealing inserts	UNI-DICHT Sealing insert, Lock bolts	86
	For AS-I-Bus cable	UNI-DICHT-ASI-MS	87
KVA	Standard	KVA-MS	88
	Pre-assembled multiple sealing insert	KVA-MFD-MS	90
	Gland body	KVA-VK-MS	92
	Sealing inserts	KVA sealing insert closed	93
		KVA sealing insert standard	94
		KVA MFDE Multiple sealing insert	95
	For AS-I-Bus cable	KVA-ASI-MS	97
		KVA sealing insert for ASI-Bus cable	98
KVA-XXL	For very large cable diameter	KVA-XXL-MS Cable gland	99
		KVA-XXL-VK-MS Gland body	100
		KVA XXL sealing insert standard	101
SD	Standard	SD	102
	For very large cable diameter	SD-XXL	103
Conventional design			
	Cable gland according to DIN	STS	104
		STV	105
		STR	106
	Flat cable gland Strain relief gland	STS-F	107
		ZE	108
		ZES	109
		ZEI	110
Thread adapter			
Adapters		Adapter hexagonal	111
		Adapter round	113
Extenders		EW round	115
Reducers		RE hexagonal	116
		RE round	118
Accessories / Parts			
	Lock nut Screw plug	KM	119
		VS	121
		VS-O	122

Cable glands for electromagnetic compatibility (EMC)

Series	Range	Item	Page
Contact: Clamp springs			
HELUTOP® HT		HELUTOP® MS-E	127
		HELUTOP® MS-EP	128
		HELUTOP® MS-EP4	130
Contact: Seal with insert			
HSK		HSK-MS-E	131
		HSK-MZ-E	132
		HSK-MS-E-D	133
Contact: Circlips			
KVA-XXL		KVA-XXL-MS-E	134
Accessories / Parts			
Lock nut Tool Accessories		KM-EMV	135
		Electricians scissors	136
		Copper tape	137

Cable glands for robust applications and special chemical resistance

Series	Range	Item	Page
Cable glands			
HELUTOP® HT	Stainless steel	HELUTOP® HT-E	140
HSK	PVDF (Polyvinylidenfluorid)	HSK-PVDF	141
	Brass with PVDF insert	HSK-MS-PVDF	143
	Stainless steel	HSK-INOX	144
UNI-DICHT	PVDF gland body	UNI-DICHT-VK-PVDF	146
	Stainless steel gland body	UNI-DICHT-VK-stainless steel	147
	Silicone sealing insert	UNI-DICHT sealing insert silicone	148
Accessories / Parts			
	Lock nut	KM-INOX	149
	Screw plug	VS-O stainless steel	150
	Reinforced wall sealing	O-ring FKM	151

Cable glands for explosive areas

Series	Range	Item	Page
Cable glands			
HELUTOP®	Plastic	HELUTOP® HT-PA-EX explosive area	153
		HELUTOP® HT-PA-EX Plus explosive area	154
HSK	Plastic	HSK-EX	156
		HSK-EX-Active	158
HELUTOP®	Brass	HELUTOP® HT-MS-EX-d cable gland	159
	Brass EMC	HELUTOP® HT-MS-EX-d 1 for copper braiding (EMC)	160
	Brass	HELUTOP® HT-MS-EX-d / e 4 for armoured cables	161
HSK	Brass	HSK-MS-EX	162
	Brass EMC	HSK-MS-EX-E	163
Thread adapter	Adapter	Adapter PA-ATEX	164
	Extension	EW PA-ATEX	166
	Reducer	RE PA-ATEX	167
Accessories / Parts			
	Screw plug	VSK-EX	168

Cable glands for special installation conditions

Series	Range	Item	Page
Cable glands			
HELUTOP®	Cable gland	HELUTOP® EASY	170
HELURFAST	Cable gland	HELURFAST - threadless cable gland	171
	Accessories / Parts	HELURFAST - Circlip pliers	172
		HELURFAST - Circlip pliers with battery hydraulic	173
		HELURFAST - inserts	174
HELUTOP® HT	Cable gland	HELUTOP® HT-Clean stainless steel cable gland	175
		HELUTOP® HT-Clean-EMV stainless steel cable gland (EMC)	176
	Strain relief class B	HELUTOP® HT-MS Plus	177
		HELUTOP® HT-MS c Plus	178
		Accessories / Parts	
Elbow	OF collapsible angle	179	
	HSSV-KF collapsible flange gland	180	
	WV elbow	181	
	WVF elbow flange	182	
	BW fastening elbow	183	
Fastener			

Cable glands for special pressure conditions

Series	Range	Item	Page
Cable glands			
HELUTOP®	Cable gland	HELUTOP® HT-AIR-PA	185
	Cable gland	HELUTOP® HT-AIR-MS	186
	Accessories / Parts	PBE-K pressure balance element	187

HELUTOP HT HSK-PVDF

HELUTOP MS-EP4

KVA-XXL-MS

HELUTOP HT-Clean



■ PLASTIC CABLE GLANDS

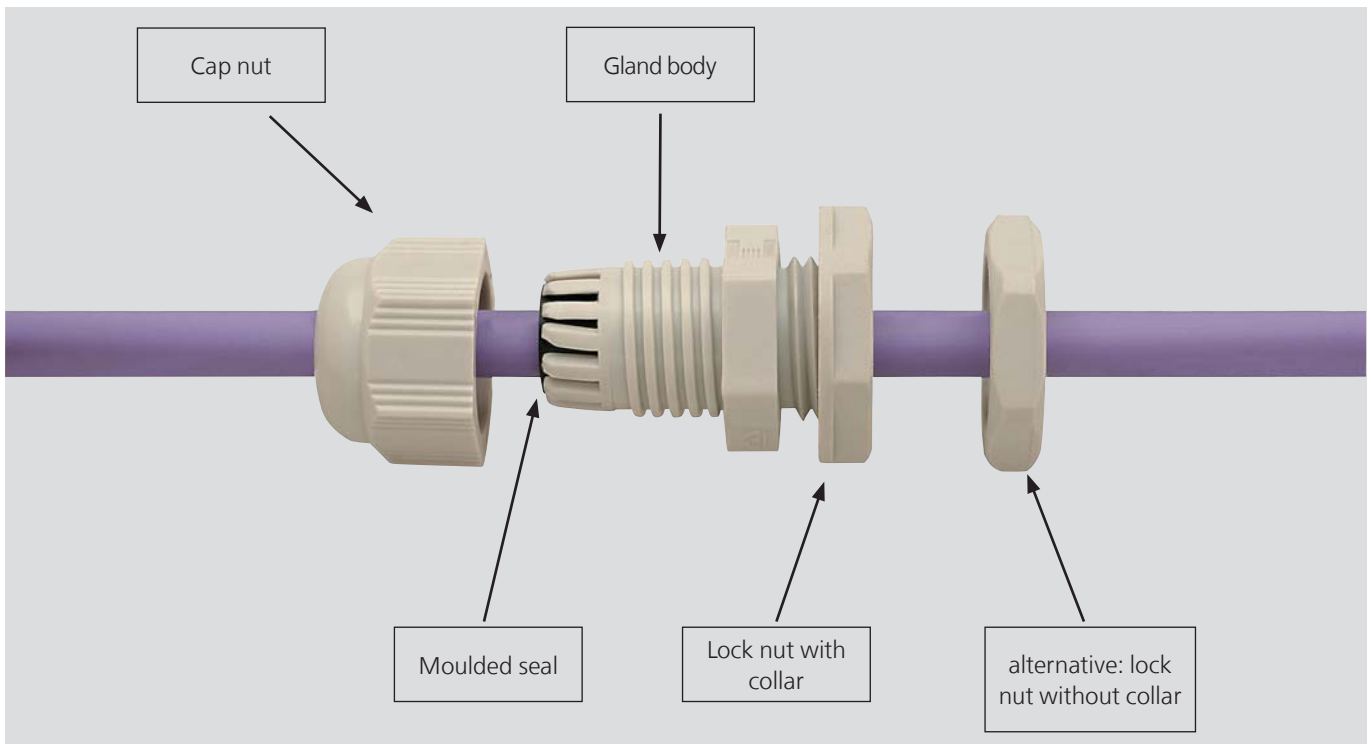

Cable gland

Cap nut and gland body are made of polyamide 6 (PA6) in the following colours

- light grey RAL 7035
- dark grey RAL 7001
- black RAL 9005

Polyamide 6 (PA6) is abrasion and impact resistant, and withstands hydrocarbons/fuels and cleaning agents. It is tried-and-tested material for cable glands in standard applications.

The moulded seal is made of chloroprene rubber (CR, Neoprene).

HELUTOP® HT and HSK cable glands are fitted with vibration protection for secure attachment in mobile applications.

Lock nut

The lock nuts with or without collar are made of polyamide 6 (PA6).

Accessories

Accessories suitable for use with the plastic cable glands:

- Lock nuts
- Adapters
- Extenders
- Reducers

Accessories suitable for use with all cable glands:

- Sealing plugs
- Multiple sealing inserts / lock bolts
- O-rings
- Connection thread gaskets
- Blind plates



HELUTOP® HT

Plastic cable gland with vibration protection.

Application

- Plant and machine construction
- Robotics
- Automation technology
- Vehicle construction and shipbuilding
- Railway technology
- Installation technology
- Control cabinet construction

Material

Polyamide PA 6
Seal: Chloroprene-rubber (CR)

- phosphor-free
- silicone-free
- cadmium-free

Properties

- Optimum strain relief through clamping lamella
- Easy to assemble
- Large clamping areas

Note

Details on the individual tests appear in section "Technical Information".

Technical data

Protection class: IP 68 - 5 bar / IP 69K

Temperature range: -20°C up to +100°C

Test standard: EN50262

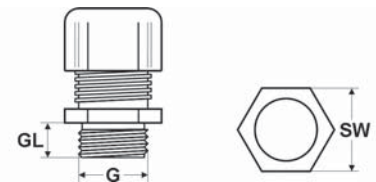

Dimensions

- G Thread size
- GL Thread length
- SW Spanner size

Metric thread

Part no. light grey RAL 7035	Part no. dark grey RAL 7001	Part no. black RAL 9005	Size Metr.	Cable Ø from / to mm	Thread length mm	Spanner size mm	Unit	Net EUR/100 items at a purchase of		
								up to 100	101 - 500	501 - 1000
93908	93923	93937	M12 x 1,5	3,0 - 6,5	8,0	15	100	o. r.	o. r.	o. r.
93909	93924	93938	M16 x 1,5	4,0 - 8,0	8,0	19	50	o. r.	o. r.	o. r.
907275	907276	907277	M16 x 1,5	5,0 - 10,0	8,0	19	50	o. r.	o. r.	o. r.
92667	92668	92669	M16 x 1,5	5,0 - 10,0	10,0	22	50	o. r.	o. r.	o. r.
93910	93925	93939	M20 x 1,5	6,0 - 12,0	10,0	24	50	o. r.	o. r.	o. r.
93911	93926	93940	M25 x 1,5	11,0 - 17,0	8,0	29	50	o. r.	o. r.	o. r.
93912	93927	93941	M32 x 1,5	15,0 - 21,0	10,0	36	25	o. r.	o. r.	o. r.
93913	93928	93942	M40 x 1,5	19,0 - 28,0	10,0	46	20	o. r.	o. r.	o. r.
93914	93929	93943	M50 x 1,5	30,0 - 38,0	18,0	60	10	o. r.	o. r.	o. r.
93915	93930	93944	M63 x 1,5	34,0 - 44,0	18,0	65	10	o. r.	o. r.	o. r.

Metric thread - with reducing seal

Part no. light grey RAL 7035	Part no. dark grey RAL 7001	Part no. black RAL 9005	Size Metr.	Cable Ø from / to mm	Thread length mm	Spanner size mm	Unit	Net EUR/100 items at a purchase of		
								up to 100	101 - 500	501 - 1000
903532	903542	903552	M12 x 1,5	2,0 - 5,0	8,0	15	100	o. r.	o. r.	o. r.
903533	903543	903553	M16 x 1,5	2,0 - 6,0	8,0	19	50	o. r.	o. r.	o. r.
903534	903544	903554	M20 x 1,5	5,0 - 9,0	10,0	24	50	o. r.	o. r.	o. r.
903535	903545	903555	M25 x 1,5	9,0 - 13,0	8,0	29	50	o. r.	o. r.	o. r.
903536	903546	903556	M32 x 1,5	11,0 - 15,0	10,0	36	25	o. r.	o. r.	o. r.
903537	903547	903557	M40 x 1,5	16,0 - 23,0	10,0	46	20	o. r.	o. r.	o. r.
903538	903548	903558	M50 x 1,5	25,0 - 31,0	18,0	60	10	o. r.	o. r.	o. r.
903539	903549	903559	M63 x 1,5	29,0 - 35,0	18,0	65	10	o. r.	o. r.	o. r.

Continuation ►

HELUTOP® HT Cable gland



PG thread

Part no. light grey RAL 7035	Part no. dark grey RAL 7001	Part no. black RAL 9005	Size PG	Cable Ø from / to mm	Thread length mm	Spanner size mm	Unit	Net EUR/100 items at a purchase of		
								up to 100	101 - 500	501 - 1000
99300	99310	99320	7	3,0 - 6,5	8,0	15	100	o. r.	o. r.	o. r.
99301	99311	99321	9	4,0 - 8,0	8,0	19	50	o. r.	o. r.	o. r.
99302	99312	99322	11	5,0 - 10,0	8,0	22	50	o. r.	o. r.	o. r.
99303	99313	99323	13,5	6,0 - 12,0	9,0	24	50	o. r.	o. r.	o. r.
99304	99314	99324	16	10,0 - 14,0	10,0	27	50	o. r.	o. r.	o. r.
99305	99315	99325	21	13,0 - 18,0	11,0	33	25	o. r.	o. r.	o. r.
99306	99316	99326	29	18,0 - 25,0	11,0	42	20	o. r.	o. r.	o. r.
99307	99317	99327	36	22,0 - 32,0	13,0	53	10	o. r.	o. r.	o. r.
99308	99318	99328	42	30,0 - 38,0	13,0	60	10	o. r.	o. r.	o. r.
99309	99319	99329	48	34,0 - 44,0	14,0	65	10	o. r.	o. r.	o. r.

NPT thread

Part no. light grey RAL 7035	Part no. dark grey RAL 7001	Part no. black RAL 9005	Size NPT	Cable Ø from / to mm	Thread length mm	Spanner size mm	Unit	Net EUR/100 items at a purchase of		
								up to 100	101 - 500	501 - 1000
92780	92790	92800	3/8"	5,0 - 10,0	15,0	22	50	o. r.	o. r.	o. r.
92781	92791	92801	1/2"	6,0 - 12,0	15,0	24	50	o. r.	o. r.	o. r.
92782	92792	92802	1/2"	10,0 - 14,0	15,0	27	50	o. r.	o. r.	o. r.
92783	92793	92803	3/4"	13,0 - 18,0	15,0	33	25	o. r.	o. r.	o. r.
92784	92794	92804	1"	18,0 - 25,0	18,0	42	20	o. r.	o. r.	o. r.

Dimensions and specifications may be changed without prior notice.

o. r. = on request

HELUTOP® HT-BS Cable gland



With dust protection



HELUTOP® HT-BS

Plastic cable gland with vibration protection and pre-assembled dust protection.

Application

- Plant and machine construction
- Robotics
- Automation technology
- Vehicle construction and shipbuilding
- Railway technology
- Installation technology
- Control cabinet construction

Material

Polyamide PA 6
Seal: Chloroprene-rubber (CR)
Dust protection: Foam rubber

- phosphor-free
- silicone-free
- cadmium-free

Properties

- Optimum strain relief through clamping lamella
- Easy to assemble
- Large clamping areas

Note

Details on the individual tests appear in section "Technical Information".
The information of the protection classification applies only by use as cable gland, not as dust cap.

Technical data

Protection class: IP 68 - 5 bar / IP 69K

Temperature range: -20°C up to +100°C

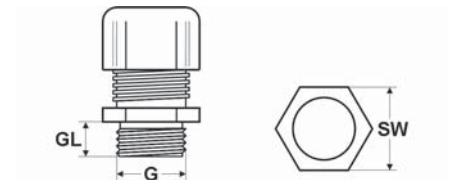

Dimensions

- G Thread size
- GL Thread length
- SW Spanner size

Metric thread

Part no. light grey RAL 7035	Part no. dark grey RAL 7001	Part no. black RAL 9005	Size Metr.	Cable Ø from / to mm	Thread length mm	Spanner size mm	Unit	Net EUR/100 items at a purchase of		
								up to 100	101 - 500	501 - 1000
94530	94540	94550	M12 x 1,5	3,0 - 6,5	8,0	15	100	o. r.	o. r.	o. r.
94531	94541	94551	M16 x 1,5	5,0 - 10,0	10,0	22	50	o. r.	o. r.	o. r.
94532	94542	94552	M20 x 1,5	6,0 - 12,0	10,0	24	50	o. r.	o. r.	o. r.
94533	94543	94553	M25 x 1,5	11,0 - 17,0	8,0	29	25	o. r.	o. r.	o. r.
94534	94544	94554	M32 x 1,5	15,0 - 21,0	10,0	36	25	o. r.	o. r.	o. r.
94535	94545	94555	M40 x 1,5	19,0 - 28,0	10,0	46	20	o. r.	o. r.	o. r.
94536	94546	94556	M50 x 1,5	30,0 - 38,0	18,0	60	10	o. r.	o. r.	o. r.
94537	94547	94557	M63 x 1,5	34,0 - 44,0	18,0	65	10	o. r.	o. r.	o. r.

Dimensions and specifications may be changed without prior notice.

o. r. = on request

HELUTOP® Protection tab



HELUTOP® Protection tab

Protection tab for sealing of not assigned cable glands HELUTOP® HT.

Application

- Plant and machine construction
- Robotics
- Automation technology
- Vehicle construction and shipbuilding
- Railway technology
- Installation technology
- Control cabinet construction

Material

Polyamide 6

Colour: black

Note

*Protection tab 903492 only for cable glands type HT and HT-MS with clamping range 5-10mm.

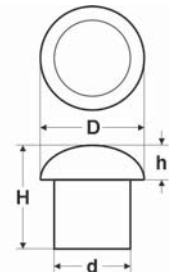

Dimensions

D	Outer diameter head
d	Outer diameter insert
H	Height total
h	Height head

Part no.	Size metric/ PG	Clamping area from/up to mm	Outer Ø head mm	Outer Ø insert mm	Height total mm	Height head mm	Unit	Net EUR/100 items at a purchase of		
								up to 100	101 - 500	501 - 1000
905924	M16/ PG7	3,0 - 6,5	9,2	6,4	11,0	4,0	100	o. r.	o. r.	o. r.
905925	M16/ PG9	4,0 - 8,0	10,5	8,0	16,0	5,0	100	o. r.	o. r.	o. r.
903492*	M16/ PG11	5,0 - 10,0	13,3	9,7	20,7	5,7	100	o. r.	o. r.	o. r.
903493	M20/ PG13,5	6,0 - 12,0	15,8	12,0	18,0	8,0	100	o. r.	o. r.	o. r.
905928	M20/ PG16	10,0 - 14,0	18,0	13,6	18,7	8,7	100	o. r.	o. r.	o. r.
903494	M25	11,0 - 17,0	19,9	16,4	18,3	7,3	100	o. r.	o. r.	o. r.
905929	M25/ PG21	13,0 - 18,0	22,2	17,8	21,0	9,7	100	o. r.	o. r.	o. r.
903495	M32	15,0 - 21,0	24,1	20,4	21,2	9,2	100	o. r.	o. r.	o. r.
903496	M40	19,0 - 28,0	32,0	27,5	25,0	9,0	100	o. r.	o. r.	o. r.

Dimensions and specifications may be changed without prior notice.

o. r. = on request

HELUTOP® HT-MFDE Multiple sealing inserts



HELUTOP® HT-MFDE

NBR multiple sealing inserts which fits in the HELUTOP® HT gland bodies made of polyamide and brass.

Application

- Plant and machine construction
- Robotics
- Automation technology
- Vehicle construction and shipbuilding
- Railway technology
- Installation technology
- Control cabinet construction

Material

NBR

Colour: black

Technical data

Temperature range: -20°C up to +100°C

Note

Sealing inserts for size M16x1,5 are suitable for cable glands M16x1,5 with clamping range 5-10mm.

Part no.	Size metric	Insert colour	Number x Ø borehole mm	Unit	Net EUR/ 100 items at a purchase of		
					up to 100	101 - 500	501 - 1000
905773	M16 x 1,5	black	2x 2,0	1	o. r.	o. r.	o. r.
920102	M16 x 1,5	black	2x 4,0	1	o. r.	o. r.	o. r.
905776	M16 x 1,5	black	3x 4,0	1	o. r.	o. r.	o. r.
905775	M16 x 1,5	black	2x 5,0	1	o. r.	o. r.	o. r.
905774	M16 x 1,5	black	2x 3,0	1	o. r.	o. r.	o. r.
920103	M20 x 1,5	black	2x 5,0	1	o. r.	o. r.	o. r.
920105	M20 x 1,5	black	3x 4,0	1	o. r.	o. r.	o. r.
920104	M20 x 1,5	black	2x 6,0	1	o. r.	o. r.	o. r.
905777	M20 x 1,5	black	4x 4,0	1	o. r.	o. r.	o. r.
920109	M20 x 1,5	black	4x 3,0	1	o. r.	o. r.	o. r.
920106	M20 x 1,5	black	3x 5,0	1	o. r.	o. r.	o. r.
920113	M25 x 1,5	black	3x 7,0	1	o. r.	o. r.	o. r.
905779	M25 x 1,5	black	5x 4,0	1	o. r.	o. r.	o. r.
905778	M25 x 1,5	black	3x 5,0	1	o. r.	o. r.	o. r.
903529	M25 x 1,5	black	7x 3,0	1	o. r.	o. r.	o. r.
920114	M25 x 1,5	black	4x 5,0	1	o. r.	o. r.	o. r.
920112	M25 x 1,5	black	3x 6,0	1	o. r.	o. r.	o. r.
920117	M25 x 1,5	black	6x 4,0	1	o. r.	o. r.	o. r.
920110	M25 x 1,5	black	2x 6,0	1	o. r.	o. r.	o. r.
920119	M32 x 1,5	black	2x 8,0	1	o. r.	o. r.	o. r.
920129	M32 x 1,5	black	9x 4,0	1	o. r.	o. r.	o. r.
904926	M32 x 1,5	black	4x 8,0	1	o. r.	o. r.	o. r.
920126	M32 x 1,5	black	6x 5,0	1	o. r.	o. r.	o. r.
905783	M32 x 1,5	black	8x 4,0	1	o. r.	o. r.	o. r.
905782	M32 x 1,5	black	4x 7,0	1	o. r.	o. r.	o. r.
903531	M32 x 1,5	black	9x 3,0	1	o. r.	o. r.	o. r.
905780	M32 x 1,5	black	2x 7,0	1	o. r.	o. r.	o. r.
920122	M32 x 1,5	black	3x 8,0	1	o. r.	o. r.	o. r.
903530	M32 x 1,5	black	6x 6,0	1	o. r.	o. r.	o. r.
920120	M32 x 1,5	black	2x 9,0	1	o. r.	o. r.	o. r.
920123	M32 x 1,5	black	4x 6,0	1	o. r.	o. r.	o. r.
905784	M32 x 1,5	black	8x 5,0	1	o. r.	o. r.	o. r.
920125	M32 x 1,5	black	5x 6,0	1	o. r.	o. r.	o. r.
905786	M40 x 1,5	black	3x 10,0	1	o. r.	o. r.	o. r.
905789	M40 x 1,5	black	6x 7,0	1	o. r.	o. r.	o. r.
905785	M40 x 1,5	black	2x 10,0	1	o. r.	o. r.	o. r.
905791	M40 x 1,5	black	9x 7,0	1	o. r.	o. r.	o. r.
905790	M40 x 1,5	black	8x 6,0	1	o. r.	o. r.	o. r.
905787	M40 x 1,5	black	4x 8,0	1	o. r.	o. r.	o. r.

Dimensions and specifications may be changed without prior notice.

o. r. = on request

Sealing plug



Sealing plug

For not assigned penetrations.

Material

black: PVDF white: POM

Technical data

Temperature range: -20°C up to +100°C

Application

- Plant and machine construction
- Robotics
- Automation technology
- Vehicle construction and shipbuilding
- Railway technology
- Installation technology
- Control cabinet construction

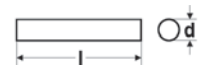

Dimensions

l Length
d Diameter

Part no. black	Diameter x Length	Unit	Net EUR/100 items at a purchase of		
			up to 100	101 - 500	501 - 1000
903515	3,0 x 25,0	100	o. r.	o. r.	o. r.
903516	4,0 x 20,0	100	o. r.	o. r.	o. r.
903517	4,0 x 25,0	100	o. r.	o. r.	o. r.
903518	5,3 x 25,0	100	o. r.	o. r.	o. r.
903519	6,0 x 25,0	100	o. r.	o. r.	o. r.
903520	6,4 x 25,0	100	o. r.	o. r.	o. r.
903521	7,0 x 25,0	100	o. r.	o. r.	o. r.
903522	7,5 x 20,0	100	o. r.	o. r.	o. r.
903523	8,0 x 20,0	100	o. r.	o. r.	o. r.
903524	9,0 x 20,0	100	o. r.	o. r.	o. r.
903525	9,3 x 20,0	100	o. r.	o. r.	o. r.
903526	10,0 x 20,0	100	o. r.	o. r.	o. r.

Part no. white	Diameter x Length	Unit	Net EUR/100 items at a purchase of		
			up to 100	101 - 500	501 - 1000
903502	3,0 x 25,0	100	o. r.	o. r.	o. r.
903503	4,0 x 20,0	100	o. r.	o. r.	o. r.
903504	4,0 x 25,0	100	o. r.	o. r.	o. r.
903505	5,0 x 25,0	100	o. r.	o. r.	o. r.
903506	6,0 x 28,0	100	o. r.	o. r.	o. r.
903507	6,4 x 25,0	100	o. r.	o. r.	o. r.
903508	7,0 x 28,0	100	o. r.	o. r.	o. r.
903509	7,5 x 20,0	100	o. r.	o. r.	o. r.
903510	8,0 x 30,0	100	o. r.	o. r.	o. r.
903511	9,0 x 30,0	100	o. r.	o. r.	o. r.
903512	10,0 x 30,0	100	o. r.	o. r.	o. r.
903513	11,0 x 30,0	100	o. r.	o. r.	o. r.
903514	12,0 x 30,0	100	o. r.	o. r.	o. r.

Dimensions and specifications may be changed without prior notice.

o. r. = on request

HELUTOP® HT-K Cable gland



With anti-kink spirals



HELUTOP® HT-K

Plastic cable gland with anti-kink spiral for mobile use.

Application

- Plant and machine construction
- Robotics
- Automation technology
- Vehicle construction and shipbuilding
- Railway technology
- Installation technology

Material

Polyamide PA 6
Seal: Chloroprene-rubber (CR)

- phosphor-free
- silicone-free
- cadmium-free

Properties

- Optimum strain relief through clamping lamella
- Easy to assemble

Note

Details on the individual tests appear in section "Technical Information".

Technical data

Protection class: IP 68 - 5 bar / IP 69K

Temperature range: -20°C up to +100°C

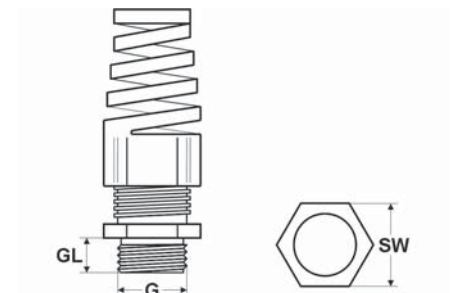

Dimensions

- G Thread size
- GL Thread length
- SW Spanner size

Metric thread

Part no. light grey RAL 7035	Part no. dark grey RAL 7001	Part no. black RAL 9005	Size Metr.	Cable Ø from / to mm	Thread length mm	Spanner size mm	Unit	Net EUR/ 100 items at a purchase of		
								up to 100	101 - 500	501 - 1000
93867	93856	93878	M12 x 1,5	3,0 - 6,5	8,0	15	100	o. r.	o. r.	o. r.
93868	93857	93879	M16 x 1,5	5,0 - 10,0	10,0	22	50	o. r.	o. r.	o. r.
93869	93858	93880	M20 x 1,5	6,0 - 12,0	10,0	24	50	o. r.	o. r.	o. r.
93870	93859	93881	M20 x 1,5	10,0 - 14,0	10,0	27	50	o. r.	o. r.	o. r.
93871	93860	93882	M25 x 1,5	13,0 - 18,0	10,0	33	25	o. r.	o. r.	o. r.

PG thread

Part no. light grey RAL 7035	Part no. dark grey RAL 7001	Part no. black RAL 9005	Size PG	Cable Ø from / to mm	Thread length mm	Spanner size mm	Unit	Net EUR/ 100 items at a purchase of		
								up to 100	101 - 500	501 - 1000
93861	93850	93872	7	3,0 - 6,5	8,0	15	100	o. r.	o. r.	o. r.
93862	93851	93873	9	4,0 - 8,0	8,0	19	50	o. r.	o. r.	o. r.
93863	93852	93874	11	5,0 - 10,0	8,0	22	50	o. r.	o. r.	o. r.
93864	93853	93875	13,5	6,0 - 12,0	9,0	24	50	o. r.	o. r.	o. r.
93865	93854	93876	16	10,0 - 14,0	10,0	27	50	o. r.	o. r.	o. r.
93866	93855	93877	21	13,0 - 18,0	11,0	33	25	o. r.	o. r.	o. r.

NPT thread

Part no. light grey RAL 7035	Part no. dark grey RAL 7001	Part no. black RAL 9005	Size NPT	Cable Ø from / to mm	Thread length mm	Spanner size mm	Unit	Net EUR/ 100 items at a purchase of		
								up to 100	101 - 500	501 - 1000
99804	99901	99905	3/8"	5,0 - 10,0	15,0	22	50	o. r.	o. r.	o. r.
99805	99902	99906	1/2"	6,0 - 12,0	15,0	24	50	o. r.	o. r.	o. r.
99806	99903	99907	3/4"	14,0 - 18,0	15,0	33	25	o. r.	o. r.	o. r.

Dimensions and specifications may be changed without prior notice.

o. r. = on request



HSK-METRICA-P

The cable gland meets high standards in technology.

Application

- Plant and machine construction
- Robotics
- Automation technology
- Vehicle construction and shipbuilding
- Railway technology
- Installation technology
- Control cabinet construction

Material

Polyamide
Seal: NBR

- halogen-free
- phosphor-free
- silicone-free
- cadmium-free

Properties

- Easy to assemble
- Completely water-tight
- Optimum strain relief
- Clamping areas with metric dimensions

Note

For the intrinsically safe area type "i" cable glands in blue, RAL 5012, are used.

Technical data

Protection class: IP 68 - 10 bar / IP 69K (within the specific clamping range with additional o-ring)

Temperature range: -40°C up to +100°C

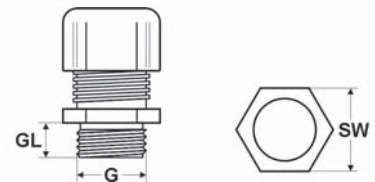

Dimensions

G Thread size
GL Thread length
SW Spanner size

Metric thread

Part no. light grey RAL 7035	Part no. black RAL 9005	Size Metr.	Cable Ø from / to mm	Thread length mm	Spanner size mm	Unit	Net EUR/100 items at a purchase of		
							up to 100	101 - 500	501 - 1000
99520	99530	M12 x 1,5	4,0 - 7,0	8,0	15	50	o. r.	o. r.	o. r.
99521	99531	M16 x 1,5	6,0 - 10,0	8,0	19	50	o. r.	o. r.	o. r.
99522	99532	M20 x 1,5	8,0 - 13,0	9,0	24	50	o. r.	o. r.	o. r.
99523	99533	M25 x 1,5	11,0 - 17,0	10,0	30	50	o. r.	o. r.	o. r.
99524	99534	M32 x 1,5	11,0 - 21,0	10,0	36	25	o. r.	o. r.	o. r.
99525	99535	M40 x 1,5	19,0 - 28,0	12,0	46	10	o. r.	o. r.	o. r.
99526	99536	M50 x 1,5	27,0 - 35,0	12,0	55	5	o. r.	o. r.	o. r.
99527	99537	M63 x 1,5	36,0 - 48,0	12,0	68	5	o. r.	o. r.	o. r.

Metric thread - for intrinsically safe application

Part no. blue RAL 5012	Size Metr.	Cable Ø from / to mm	Thread length mm	Spanner size mm	Unit	Net EUR/100 items at a purchase of		
						up to 100	101 - 500	501 - 1000
99540	M12 x 1,5	4,0 - 7,0	8,0	15	50	o. r.	o. r.	o. r.
99541	M16 x 1,5	6,0 - 10,0	8,0	19	50	o. r.	o. r.	o. r.
99542	M20 x 1,5	8,0 - 13,0	9,0	24	50	o. r.	o. r.	o. r.
99543	M25 x 1,5	11,0 - 17,0	10,0	30	50	o. r.	o. r.	o. r.
99544	M32 x 1,5	11,0 - 21,0	10,0	36	25	o. r.	o. r.	o. r.
99545	M40 x 1,5	19,0 - 28,0	12,0	46	10	o. r.	o. r.	o. r.
99546	M50 x 1,5	27,0 - 35,0	12,0	55	5	o. r.	o. r.	o. r.
99547	M63 x 1,5	36,0 - 48,0	12,0	68	5	o. r.	o. r.	o. r.

Dimensions and specifications may be changed without prior notice.

o. r. = on request



HSK

This cable gland meets the highest standards in technology.

Application

- Plant and machine construction
- Robotics
- Automation technology
- Vehicle construction and shipbuilding
- Railway technology
- Installation technology
- Control cabinet construction

Material

Polyamide
Seal: NBR

- halogen-free
- phosphor-free
- silicone-free
- cadmium-free

Properties

- Easy to assemble
- Completely water-tight
- Optimum strain relief
- Large Clamping areas

Note

For the intrinsically safe area, type "i" cable glands in blue, RAL 5012, are used.

Technical data

Protection class: IP 68 - 10 bar / IP 69K (within the specific clamping range with additional o-ring)

Temperature range: -40°C up to +100°C

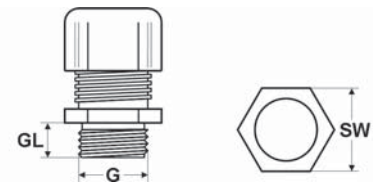

Dimensions

- G Thread size
- GL Thread length
- SW Spanner size

Metric thread

Part no. light grey RAL 7035	Part no. black RAL 9005	Size Metr.	Cable Ø from / to mm	Thread length mm	Spanner size mm	Unit	Net EUR/100 items at a purchase of		
							up to 100	101 - 500	501 - 1000
97558	97550	M12 x 1,5	3,0 - 6,5	8,0	15	50	o. r.	o. r.	o. r.
96967	97551	M16 x 1,5	4,0 - 8,0	8,0	19	50	o. r.	o. r.	o. r.
97956	97960	M16 x 1,5	5,0 - 10,0	8,0	22	50	o. r.	o. r.	o. r.
96968	97552	M20 x 1,5	6,0 - 12,0	9,0	24	50	o. r.	o. r.	o. r.
97957	97961	M20 x 1,5	10,0 - 14,0	9,0	27	50	o. r.	o. r.	o. r.
96969	97553	M25 x 1,5	13,0 - 18,0	11,0	33	50	o. r.	o. r.	o. r.
96970	97554	M32 x 1,5	18,0 - 25,0	11,0	42	25	o. r.	o. r.	o. r.
96971	97555	M40 x 1,5	22,0 - 32,0	13,0	53	10	o. r.	o. r.	o. r.
96972	97556	M50 x 1,5	32,0 - 38,0	13,0	60	5	o. r.	o. r.	o. r.
96973	97557	M63 x 1,5	37,0 - 44,0	14,0	65 / 68	5	o. r.	o. r.	o. r.

Metric thread - for intrinsically safe application

Part no. blue RAL 5012	Size Metr.	Cable Ø from / to mm	Thread length mm	Spanner size mm	Unit	Net EUR/100 items at a purchase of		
						up to 100	101 - 500	501 - 1000
97967	M12 x 1,5	3,0 - 6,5	8,0	15	50	o. r.	o. r.	o. r.
97968	M16 x 1,5	4,0 - 8,0	8,0	19	50	o. r.	o. r.	o. r.
97969	M16 x 1,5	5,0 - 10,0	8,0	22	50	o. r.	o. r.	o. r.
97970	M20 x 1,5	6,0 - 12,0	9,0	24	50	o. r.	o. r.	o. r.
97971	M20 x 1,5	10,0 - 14,0	9,0	27	50	o. r.	o. r.	o. r.
97972	M25 x 1,5	13,0 - 18,0	11,0	33	50	o. r.	o. r.	o. r.
97973	M32 x 1,5	18,0 - 25,0	11,0	42	25	o. r.	o. r.	o. r.
97974	M40 x 1,5	22,0 - 32,0	13,0	53	10	o. r.	o. r.	o. r.
97975	M50 x 1,5	32,0 - 38,0	13,0	60	5	o. r.	o. r.	o. r.
97976	M63 x 1,5	37,0 - 44,0	14,0	65 / 68	5	o. r.	o. r.	o. r.

Continuation ►

Metric thread - with reducing seal

Part no. light grey RAL 7035	Part no. black RAL 9005	Size Metr.	Cable Ø from / to mm	Thread length mm	Spanner size mm	Unit	Net EUR/100 items at a purchase of		
							up to 100	101 - 500	501 - 1000
97873	98205	M12 x 1,5	2,0 - 5,0	8,0	15	50	o. r.	o. r.	o. r.
96974	97977	M16 x 1,5	2,0 - 6,0	8,0	19	50	o. r.	o. r.	o. r.
96975	97979	M20 x 1,5	5,0 - 9,0	9,0	24	50	o. r.	o. r.	o. r.
96976	97981	M25 x 1,5	9,0 - 16,0	11,0	33	50	o. r.	o. r.	o. r.
96977	97982	M32 x 1,5	13,0 - 20,0	11,0	42	25	o. r.	o. r.	o. r.
96978	97983	M40 x 1,5	20,0 - 26,0	13,0	53	10	o. r.	o. r.	o. r.
96979	97984	M50 x 1,5	25,0 - 31,0	13,0	60	5	o. r.	o. r.	o. r.
96980	97985	M63 x 1,5	29,0 - 35,0	14,0	65 / 68	5	o. r.	o. r.	o. r.

Metric thread - with reducing seal - for intrinsically safe application

Part no. blue RAL 5012	Size Metr.	Cable Ø from / to mm	Thread length mm	Spanner size mm	Unit	Net EUR/100 items at a purchase of		
						up to 100	101 - 500	501 - 1000
91826	M12 x 1,5	2,0 - 5,0	8,0	15	50	o. r.	o. r.	o. r.
91827	M16 x 1,5	2,0 - 6,0	8,0	19	50	o. r.	o. r.	o. r.
91828	M20 x 1,5	5,0 - 9,0	9,0	24	50	o. r.	o. r.	o. r.
91829	M25 x 1,5	9,0 - 16,0	11,0	33	50	o. r.	o. r.	o. r.
91830	M32 x 1,5	13,0 - 20,0	11,0	42	25	o. r.	o. r.	o. r.
91831	M40 x 1,5	20,0 - 26,0	13,0	53	10	o. r.	o. r.	o. r.
91832	M50 x 1,5	25,0 - 31,0	13,0	60	5	o. r.	o. r.	o. r.
91833	M63 x 1,5	29,0 - 35,0	14,0	65 / 68	5	o. r.	o. r.	o. r.

PG thread

Part no. light grey RAL 7035	Part no. black RAL 9005	Size PG	Cable Ø from / to mm	Thread length mm	Spanner size mm	Unit	Net EUR/100 items at a purchase of		
							up to 100	101 - 500	501 - 1000
90000	90020	7	3,0 - 6,5	8,0	15	50	o. r.	o. r.	o. r.
90001	90021	9	4,0 - 8,0	8,0	19	50	o. r.	o. r.	o. r.
90002	90022	11	5,0 - 10,0	8,0	22	50	o. r.	o. r.	o. r.
90003	90023	13,5	6,0 - 12,0	9,0	24	50	o. r.	o. r.	o. r.
90004	90024	16	10,0 - 14,0	10,0	27	50	o. r.	o. r.	o. r.
90005	90025	21	13,0 - 18,0	11,0	33	50	o. r.	o. r.	o. r.
90006	90026	29	18,0 - 25,0	11,0	42	25	o. r.	o. r.	o. r.
90007	90027	36	22,0 - 32,0	13,0	53	10	o. r.	o. r.	o. r.
90008	90028	42	32,0 - 38,0	13,0	60	5	o. r.	o. r.	o. r.
90009	90029	48	37,0 - 44,0	14,0	65	5	o. r.	o. r.	o. r.

PG thread - for intrinsically safe application

Part no. blue RAL 5012	Size PG	Cable Ø from / to mm	Thread length mm	Spanner size mm	Unit	Net EUR/100 items at a purchase of		
						up to 100	101 - 500	501 - 1000
96106	7	3,0 - 6,5	8,0	15	50	o. r.	o. r.	o. r.
96107	9	4,0 - 8,0	8,0	19	50	o. r.	o. r.	o. r.
96108	11	5,0 - 10,0	8,0	22	50	o. r.	o. r.	o. r.
96456	13,5	6,0 - 12,0	9,0	24	50	o. r.	o. r.	o. r.
96455	16	10,0 - 14,0	10,0	27	50	o. r.	o. r.	o. r.
96912	21	13,0 - 18,0	11,0	33	50	o. r.	o. r.	o. r.
97802	29	18,0 - 25,0	11,0	42	25	o. r.	o. r.	o. r.
97803	36	22,0 - 32,0	13,0	53	10	o. r.	o. r.	o. r.
97965	42	32,0 - 38,0	13,0	60	5	o. r.	o. r.	o. r.
97966	48	37,0 - 44,0	14,0	65	5	o. r.	o. r.	o. r.

PG thread - with reducing seal

Part no. light grey RAL 7035	Part no. black RAL 9005	Size PG	Cable Ø from / to mm	Thread length mm	Spanner size mm	Unit	Net EUR/100 items at a purchase of		
							up to 100	101 - 500	501 - 1000
90010	98290	7	2,0 - 5,0	8,0	15	50	o. r.	o. r.	o. r.
90011	96883	9	2,0 - 6,0	8,0	19	50	o. r.	o. r.	o. r.
90012	96104	11	3,0 - 7,0	8,0	22	50	o. r.	o. r.	o. r.
90013	96544	13,5	5,0 - 9,0	9,0	24	50	o. r.	o. r.	o. r.
90014	96105	16	7,0 - 12,0	10,0	27	50	o. r.	o. r.	o. r.
90015	97306	21	9,0 - 16,0	11,0	33	50	o. r.	o. r.	o. r.
90016	96403	29	13,0 - 20,0	11,0	42	25	o. r.	o. r.	o. r.
90017	98202	36	20,0 - 26,0	13,0	53	10	o. r.	o. r.	o. r.
90018	98203	42	25,0 - 31,0	13,0	60	5	o. r.	o. r.	o. r.
90019	98204	48	29,0 - 35,0	14,0	65	5	o. r.	o. r.	o. r.

PG thread - with reducing seal - for intrinsically safe application

Part no. blue RAL 5012	Size PG	Cable Ø from / to mm	Thread length mm	Spanner size mm	Unit	Net EUR/100 items at a purchase of		
						up to 100	101 - 500	501 - 1000
91816	7	2,0 - 5,0	8,0	15	50	o. r.	o. r.	o. r.
91817	9	2,0 - 6,0	8,0	19	50	o. r.	o. r.	o. r.
91818	11	3,0 - 7,0	8,0	22	50	o. r.	o. r.	o. r.
91819	13,5	5,0 - 9,0	9,0	24	50	o. r.	o. r.	o. r.
91820	16	7,0 - 12,0	10,0	27	50	o. r.	o. r.	o. r.
91821	21	9,0 - 16,0	11,0	33	50	o. r.	o. r.	o. r.
91822	29	13,0 - 20,0	11,0	42	25	o. r.	o. r.	o. r.
91823	36	20,0 - 26,0	13,0	53	10	o. r.	o. r.	o. r.
91824	42	25,0 - 31,0	13,0	60	5	o. r.	o. r.	o. r.
91825	48	29,0 - 35,0	14,0	65	5	o. r.	o. r.	o. r.

Continuation ▶

NPT thread

Part no. light grey RAL 7035	Part no. black RAL 9005	Size NPT	Cable Ø from / to mm	Thread length mm	Spanner size mm	Unit	Net EUR/ 100 items at a purchase of		
							up to 100	101 - 500	501 - 1000
91630	91637	3/8"	4,0 - 8,0	15,0	19 / 22	50	o. r.	o. r.	o. r.
91631	91638	1/2"	6,0 - 12,0	13,0	24	50	o. r.	o. r.	o. r.
91632	91639	1/2"	10,0 - 14,0	13,0	27	50	o. r.	o. r.	o. r.
91633	91640	3/4"	13,0 - 18,0	14,0	33	50	o. r.	o. r.	o. r.
91634	91641	1"	18,0 - 25,0	19,0	42	25	o. r.	o. r.	o. r.
91635	91642	1,25"	18,0 - 25,0	16,0	42 / 46	10	o. r.	o. r.	o. r.
91636	91643	1,5"	22,0 - 32,0	20,0	53	5	o. r.	o. r.	o. r.

NPT thread - for intrinsically safe application

Part no. blue RAL 5012	Size NPT	Cable Ø from / to mm	Thread length mm	Spanner size mm	Unit	Net EUR/ 100 items at a purchase of		
						up to 100	101 - 500	501 - 1000
91644	3/8"	4,0 - 8,0	15,0	19 / 22	50	o. r.	o. r.	o. r.
91645	1/2"	6,0 - 12,0	13,0	24	50	o. r.	o. r.	o. r.
91646	1/2"	10,0 - 14,0	13,0	27	50	o. r.	o. r.	o. r.
91647	3/4"	13,0 - 18,0	14,0	33	50	o. r.	o. r.	o. r.
91648	1"	18,0 - 25,0	19,0	42	25	o. r.	o. r.	o. r.
91649	1,25"	18,0 - 25,0	16,0	42 / 46	10	o. r.	o. r.	o. r.
91650	1,5"	22,0 - 32,0	20,0	53	5	o. r.	o. r.	o. r.

NPT thread - with reducing seal

Part no. light grey RAL 7035	Part no. black RAL 9005	Size NPT	Cable Ø from / to mm	Thread length mm	Spanner size mm	Unit	Net EUR/ 100 items at a purchase of		
							up to 100	101 - 500	501 - 1000
92610	92620	3/8"	2,0 - 6,0	15,0	19 / 22	50	o. r.	o. r.	o. r.
92611	92621	1/2"	5,0 - 9,0	13,0	24	50	o. r.	o. r.	o. r.
92612	92622	1/2"	7,0 - 12,0	13,0	27	50	o. r.	o. r.	o. r.
92613	92623	3/4"	9,0 - 16,0	14,0	33	50	o. r.	o. r.	o. r.
92614	92624	1"	13,0 - 20,0	19,0	42	25	o. r.	o. r.	o. r.
92615	92625	1,25"	13,0 - 20,0	16,0	42 / 46	10	o. r.	o. r.	o. r.
92616	92626	1,5"	20,0 - 26,0	20,0	53	5	o. r.	o. r.	o. r.

NPT thread - with reducing seal - for intrinsically safe application

Part no. blue RAL 5012	Size NPT	Cable Ø from / to mm	Thread length mm	Spanner size mm	Unit	Net EUR/ 100 items at a purchase of		
						up to 100	101 - 500	501 - 1000
92630	3/8"	2,0 - 6,0	15,0	19 / 22	50	o. r.	o. r.	o. r.
92631	1/2"	5,0 - 9,0	13,0	24	50	o. r.	o. r.	o. r.
92632	1/2"	7,0 - 12,0	13,0	27	50	o. r.	o. r.	o. r.
92633	3/4"	9,0 - 16,0	14,0	33	50	o. r.	o. r.	o. r.
92634	1"	13,0 - 20,0	19,0	42	25	o. r.	o. r.	o. r.
92635	1,25"	13,0 - 20,0	16,0	42 / 46	10	o. r.	o. r.	o. r.
92636	1,5"	20,0 - 26,0	20,0	53	5	o. r.	o. r.	o. r.

Dimensions and specifications may be changed without prior notice.

o. r. = on request

HSK-L Cable gland

Long thread



HSK-L

With long threaded connection

Application

- Plant and machine construction
- Robotics
- Automation technology
- Vehicle construction and shipbuilding
- Railway technology
- Installation technology
- Control cabinet construction

Material

PA 6, V0 acc. to UL 94
Seal: NBR

- halogen-free
- phosphor-free
- silicone-free
- cadmium-free

Properties

- Easy to assemble
- Completely watertight
- Optimum strain relief
- Large clamping areas

Note

For the intrinsically safe area, type "I" cable glands in blue, RAL 5012, are used.

Technical data

Protection class: IP 68 - 10 bar / IP 69K (within the specific clamping range with additional o-ring)

Temperature range: -40°C up to +100°C

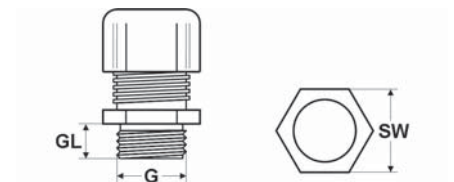

Dimensions

G Thread size
GL Thread length
SW Spanner size

Metric thread

Part no. light grey RAL 7035	Part no. black RAL 9005	Size Metr.	Cable Ø from / to mm	Thread length mm	Spanner size mm	Unit	Net EUR/100 items at a purchase of		
							up to 100	101 - 500	501 - 1000
91690	91700	M12 x 1,5	3,0 - 6,5	15,0	15	50	o. r.	o. r.	o. r.
91691	91701	M16 x 1,5	4,0 - 8,0	15,0	19	50	o. r.	o. r.	o. r.
99841	99849	M16 x 1,5	5,0 - 10,0	15,0	22	50	o. r.	o. r.	o. r.
99842	99850	M20 x 1,5	6,0 - 12,0	15,0	24	50	o. r.	o. r.	o. r.
99843	99851	M20 x 1,5	10,0 - 14,0	15,0	27	50	o. r.	o. r.	o. r.
99844	99852	M25 x 1,5	13,0 - 18,0	15,0	33	50	o. r.	o. r.	o. r.
99845	99853	M32 x 1,5	18,0 - 25,0	15,0	42	25	o. r.	o. r.	o. r.
99846	99854	M40 x 1,5	22,0 - 32,0	18,0	53	10	o. r.	o. r.	o. r.
99847	99855	M50 x 1,5	32,0 - 38,0	18,0	60	5	o. r.	o. r.	o. r.
99848	99856	M63 x 1,5	37,0 - 44,0	18,0	65 / 68	5	o. r.	o. r.	o. r.

Continuation ►

Long thread

Metric thread - for intrinsically safe application

Part no. blue RAL 5012	Size Metr.	Cable Ø from / to mm	Thread length mm	Spanner size mm	Unit	Net EUR/ 100 items at a purchase of		
						up to 100	101 - 500	501 - 1000
91710	M12 x 1,5	3,0 - 6,5	15,0	15	50	o. r.	o. r.	o. r.
91711	M16 x 1,5	4,0 - 8,0	15,0	19	50	o. r.	o. r.	o. r.
99857	M16 x 1,5	5,0 - 10,0	15,0	22	50	o. r.	o. r.	o. r.
99858	M20 x 1,5	6,0 - 12,0	15,0	24	50	o. r.	o. r.	o. r.
99859	M20 x 1,5	10,0 - 14,0	15,0	27	50	o. r.	o. r.	o. r.
99860	M25 x 1,5	13,0 - 18,0	15,0	33	50	o. r.	o. r.	o. r.
99861	M32 x 1,5	18,0 - 25,0	15,0	42	25	o. r.	o. r.	o. r.
99862	M40 x 1,5	22,0 - 32,0	18,0	53	10	o. r.	o. r.	o. r.
99863	M50 x 1,5	32,0 - 38,0	18,0	60	5	o. r.	o. r.	o. r.
99864	M63 x 1,5	37,0 - 44,0	18,0	65 / 68	5	o. r.	o. r.	o. r.

Metric thread - with reducing seal

Part no. light grey RAL 7035	Part no. black RAL 9005	Size Metr.	Cable Ø from / to mm	Thread length mm	Spanner size mm	Unit	Net EUR/ 100 items at a purchase of		
							up to 100	101 - 500	501 - 1000
91692	91702	M20 x 1,5	5,0 - 9,0	15,0	24	50	o. r.	o. r.	o. r.
91693	91703	M25 x 1,5	9,0 - 16,0	15,0	33	50	o. r.	o. r.	o. r.
91694	91704	M32 x 1,5	13,0 - 20,0	15,0	42	25	o. r.	o. r.	o. r.
91695	91705	M40 x 1,5	20,0 - 26,0	18,0	53	10	o. r.	o. r.	o. r.
91696	91706	M50 x 1,5	25,0 - 31,0	18,0	60	5	o. r.	o. r.	o. r.
91697	91707	M63 x 1,5	29,0 - 35,0	18,0	65 / 68	5	o. r.	o. r.	o. r.

Metric thread - with reducing seal - for intrinsically safe application

Part no. blue RAL 5012	Size Metr.	Cable Ø from / to mm	Thread length mm	Spanner size mm	Unit	Net EUR/ 100 items at a purchase of		
						up to 100	101 - 500	501 - 1000
91712	M20 x 1,5	5,0 - 9,0	15,0	24	50	o. r.	o. r.	o. r.
91713	M25 x 1,5	9,0 - 16,0	15,0	33	50	o. r.	o. r.	o. r.
91714	M32 x 1,5	13,0 - 20,0	15,0	42	25	o. r.	o. r.	o. r.
91715	M40 x 1,5	20,0 - 26,0	18,0	53	10	o. r.	o. r.	o. r.
91716	M50 x 1,5	25,0 - 31,0	18,0	60	5	o. r.	o. r.	o. r.
91717	M63 x 1,5	29,0 - 35,0	18,0	65 / 68	5	o. r.	o. r.	o. r.

PG thread

Part no. light grey RAL 7035	Part no. black RAL 9005	Size PG	Cable Ø from / to mm	Thread length mm	Spanner size mm	Unit	Net EUR/ 100 items at a purchase of		
							up to 100	101 - 500	501 - 1000
90040	97418	7	3,0 - 6,5	15,0	15	50	o. r.	o. r.	o. r.
90041	97419	9	4,0 - 8,0	15,0	19	50	o. r.	o. r.	o. r.
90042	96405	11	5,0 - 10,0	15,0	22	50	o. r.	o. r.	o. r.
90043	96404	13,5	6,0 - 12,0	15,0	24	50	o. r.	o. r.	o. r.
90044	96003	16	10,0 - 14,0	15,0	27	50	o. r.	o. r.	o. r.
90045	97767	21	13,0 - 18,0	15,0	33	50	o. r.	o. r.	o. r.
90046	96004	29	18,0 - 25,0	15,0	42	25	o. r.	o. r.	o. r.
90047	96253	36	22,0 - 32,0	18,0	53	10	o. r.	o. r.	o. r.
90048	96254	42	32,0 - 38,0	18,0	60	5	o. r.	o. r.	o. r.
90049	96256	48	37,0 - 44,0	18,0	65	5	o. r.	o. r.	o. r.

PG thread - for intrinsically safe application

Part no. blue RAL 5012	Size PG	Cable Ø from / to mm	Thread length mm	Spanner size mm	Unit	Net EUR/ 100 items at a purchase of		
						up to 100	101 - 500	501 - 1000
91680	7	3,0 - 6,5	15,0	15	50	o. r.	o. r.	o. r.
91681	9	4,0 - 8,0	15,0	19	50	o. r.	o. r.	o. r.
91682	11	5,0 - 10,0	15,0	22	50	o. r.	o. r.	o. r.
91683	13,5	6,0 - 12,0	15,0	24	50	o. r.	o. r.	o. r.
91684	16	10,0 - 14,0	15,0	27	50	o. r.	o. r.	o. r.
91685	21	13,0 - 18,0	15,0	33	50	o. r.	o. r.	o. r.
91686	29	18,0 - 25,0	15,0	42	25	o. r.	o. r.	o. r.
91687	36	22,0 - 32,0	18,0	53	10	o. r.	o. r.	o. r.
91688	42	32,0 - 38,0	18,0	60	5	o. r.	o. r.	o. r.
91689	48	37,0 - 44,0	18,0	65	5	o. r.	o. r.	o. r.

Dimensions and specifications may be changed without prior notice.

o. r. = on request

HSK-B Cable gland

Anti-kink



HSK-B

With anti-kink spirals

Application

- Plant and machine construction
- Robotics
- Automation technology
- Vehicle construction and shipbuilding
- Railway technology
- Installation technology
- Control cabinet construction

Material

Polyamide
Seal: NBR

- halogen-free
- phosphor-free
- silicone-free
- cadmium-free

Properties

- Easy to assemble
- Completely water-tight
- Optimum strain relief
- Large clamping ranges

Technical data

Protection class: IP 68 - 10 bar / IP 69K (within the specific clamping range with additional o-ring)

Temperature range: -40°C up to +100°C

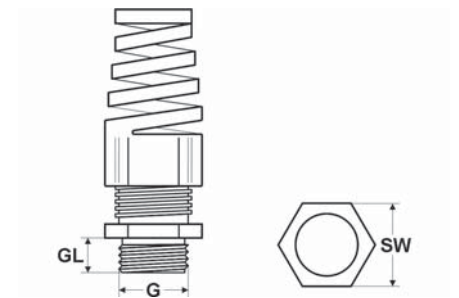

Dimensions

G Thread size
GL Thread length
SW Spanner size

Metric thread

Part no. light grey RAL 7035	Part no. black RAL 9005	Size Metr.	Cable Ø from / to mm	Thread length mm	Spanner size mm	Unit	Net EUR/100 items at a purchase of		
							up to 100	101 - 500	501 - 1000
98005	98011	M12 x 1,5	3,0 - 6,5	8,0	15	50	o. r.	o. r.	o. r.
98006	98012	M16 x 1,5	4,0 - 8,0	8,0	19	50	o. r.	o. r.	o. r.
98008	98014	M20 x 1,5	6,0 - 12,0	9,0	24	50	o. r.	o. r.	o. r.
98009	98015	M20 x 1,5	10,0 - 14,0	9,0	27	25	o. r.	o. r.	o. r.
98010	98016	M25 x 1,5	13,0 - 18,0	11,0	33	20	o. r.	o. r.	o. r.

PG thread

Part no. light grey RAL 7035	Part no. black RAL 9005	Size PG	Cable Ø from / to mm	Thread length mm	Spanner size mm	Unit	Net EUR/100 items at a purchase of		
							up to 100	101 - 500	501 - 1000
90320	90326	7	3,0 - 6,5	8,0	15	50	o. r.	o. r.	o. r.
90321	90327	9	4,0 - 8,0	8,0	19	50	o. r.	o. r.	o. r.
90322	90328	11	5,0 - 10,0	8,0	22	50	o. r.	o. r.	o. r.
90323	90329	13,5	6,0 - 12,0	9,0	24	50	o. r.	o. r.	o. r.
90324	90330	16	10,0 - 14,0	10,0	27	25	o. r.	o. r.	o. r.
90325	90331	21	13,0 - 18,0	11,0	33	20	o. r.	o. r.	o. r.

NPT thread

Part no. light grey RAL 7035	Part no. black RAL 9005	Size NPT	Cable Ø from / to mm	Thread length mm	Spanner size mm	Unit	Net EUR/100 items at a purchase of		
							up to 100	101 - 500	501 - 1000
92300	92305	3/8"	4,0 - 8,0	15,0	22 / 19	50	o. r.	o. r.	o. r.
92301	92306	1/2"	6,0 - 12,0	13,0	24	50	o. r.	o. r.	o. r.
92302	92307	1/2"	10,0 - 14,0	13,0	27	25	o. r.	o. r.	o. r.
92303	92308	3/4"	13,0 - 18,0	14,0	33	20	o. r.	o. r.	o. r.

Dimensions and specifications may be changed without prior notice.

o. r. = on request



HSK-WI

Foldable elbow gland for simple cable insertion. The profile can be re-opened at any time.

Application

- Plant and machine construction
- Robotics
- Automation technology
- Vehicle construction and shipbuilding
- Railway technology
- Installation technology
- Control cabinet construction

Material

Polyamide
Seal: NBR
O-ring: NBR

- halogen-free
- phosphor-free
- silicone-free
- cadmium-free

Note

Elbow gland with NPT thread without O-Ring

Technical data

Protection class: IP 68

Temperature range: -40°C up to +100°C

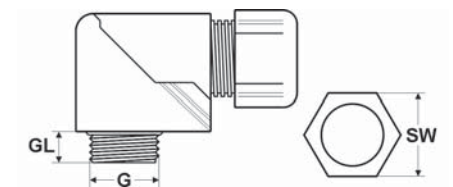

Dimensions

G Thread size
GL Thread length
SW Spanner size

Metric thread

Part no. light grey RAL 7035	Part no. black RAL 9005	Size Metr.	Cable Ø from / to mm	Thread length mm	Spanner size mm	Unit	Net EUR/100 items at a purchase of		
							up to 100	101 - 500	501 - 1000
91284	91840	M16 x 1,5	4,0 - 8,0	8,0	19	25	o. r.	o. r.	o. r.
91285	91841	M20 x 1,5	6,0 - 12,0	9,0	24	25	o. r.	o. r.	o. r.
91286	91842	M25 x 1,5	13,0 - 18,0	11,0	33	10	o. r.	o. r.	o. r.
91287	91843	M32 x 1,5	18,0 - 25,0	11,0	42	5	o. r.	o. r.	o. r.

PG thread

Part no. light grey RAL 7035	Part no. black RAL 9005	Size PG	Cable Ø from / to mm	Thread length mm	Spanner size mm	Unit	Net EUR/100 items at a purchase of		
							up to 100	101 - 500	501 - 1000
96981	96581	9	4,0 - 8,0	8,0	19	25	o. r.	o. r.	o. r.
96982	96103	11	5,0 - 10,0	8,0	22	25	o. r.	o. r.	o. r.
96983	96582	13,5	6,0 - 12,0	9,0	24	25	o. r.	o. r.	o. r.
96984	96583	16	10,0 - 14,0	10,0	27	25	o. r.	o. r.	o. r.
96985	96584	21	13,0 - 18,0	11,0	33	10	o. r.	o. r.	o. r.
96986	96406	29	18,0 - 25,0	11,0	42	5	o. r.	o. r.	o. r.

NPT thread

Part no. light grey RAL 7035	Part no. black RAL 9005	Size NPT	Cable Ø from / to mm	Thread length mm	Spanner size mm	Unit	Net EUR/100 items at a purchase of		
							up to 100	101 - 500	501 - 1000
92690	92700	3/8"	4,0 - 8,0	15,0	19	25	o. r.	o. r.	o. r.
92691	92701	1/2"	6,0 - 12,0	13,0	24	25	o. r.	o. r.	o. r.
92692	92702	1/2"	10,0 - 14,0	13,0	27	25	o. r.	o. r.	o. r.
92693	92703	3/4"	13,0 - 18,0	13,0	33	20	o. r.	o. r.	o. r.
92694	92704	1"	18,0 - 25,0	19,0	42	5	o. r.	o. r.	o. r.

Dimensions and specifications may be changed without prior notice.

o. r. = on request



UNI-DICHT-PA

Plastic sealing gland with colour-coded TPE inserts.

Material

Polyamide PA6-3
Seal: TPE

- halogen-free
- phosphor-free
- silicone-free
- cadmium-free

Properties

- Extensive cable sealing
- Easy to assemble
- Large clamping areas

Note

Black cable glands are available on request.
UL- and CSA- approval for use with TPE-V inserts. TPE-V inserts on request.

Technical data

Protection class: IP 68 - 10 bar

Temperature range: -20°C up to +100°C

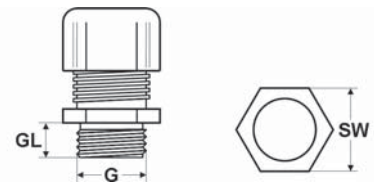

Dimensions

G Thread size
GL Thread length
SW Spanner size

Metric thread

Part no.	Size Metr.	Sealing insert colour	Cable Ø from / to mm	Thread length mm	Spanner size mm	Unit	Net EUR/ 100 items at a purchase of		
							up to 100	101 - 500	501 - 1000
903800	M12 x 1,5	yellow	4,0 - 6,5	8,0	15	50	o. r.	o. r.	o. r.
903801	M16 x 1,5	yellow	4,0 - 6,5	9,0	19	50	o. r.	o. r.	o. r.
903802	M16 x 1,5	grey	5,0 - 8,0	9,0	19	50	o. r.	o. r.	o. r.
903803	M16 x 1,5	black	6,5 - 9,5	9,0	19	50	o. r.	o. r.	o. r.
903804	M20 x 1,5	yellow	4,0 - 6,5	9,0	24	50	o. r.	o. r.	o. r.
903805	M20 x 1,5	grey	5,0 - 8,0	9,0	24	50	o. r.	o. r.	o. r.
903806	M20 x 1,5	black	6,5 - 9,5	9,0	24	50	o. r.	o. r.	o. r.
903807	M20 x 1,5	green	7,0 - 10,5	9,0	24	50	o. r.	o. r.	o. r.
903808	M20 x 1,5	red	9,0 - 13,0	9,0	24	50	o. r.	o. r.	o. r.
903809	M25 x 1,5	yellow	4,0 - 6,5	9,0	30	50	o. r.	o. r.	o. r.
903810	M25 x 1,5	grey	5,0 - 8,0	9,0	30	50	o. r.	o. r.	o. r.
903811	M25 x 1,5	black	6,5 - 9,5	9,0	30	50	o. r.	o. r.	o. r.
903812	M25 x 1,5	green	7,0 - 10,5	9,0	30	50	o. r.	o. r.	o. r.
903813	M25 x 1,5	red	9,0 - 13,0	9,0	30	50	o. r.	o. r.	o. r.
903814	M25 x 1,5	white	11,5 - 15,5	9,0	30	50	o. r.	o. r.	o. r.
903815	M32 x 1,5	green	7,0 - 10,5	11,0	36	25	o. r.	o. r.	o. r.
903816	M32 x 1,5	red	9,0 - 13,0	11,0	36	25	o. r.	o. r.	o. r.
903817	M32 x 1,5	white	11,5 - 15,5	11,0	36	25	o. r.	o. r.	o. r.
903818	M32 x 1,5	blue	14,0 - 18,0	11,0	36	25	o. r.	o. r.	o. r.
903819	M32 x 1,5	brown	17,0 - 20,5	11,0	36	25	o. r.	o. r.	o. r.
903820	M40 x 1,5	blue	14,0 - 18,0	11,5	46	10	o. r.	o. r.	o. r.
903821	M40 x 1,5	brown	17,0 - 20,5	11,5	46	10	o. r.	o. r.	o. r.
903822	M40 x 1,5	orange	20,0 - 25,0	11,5	46	10	o. r.	o. r.	o. r.
903823	M40 x 1,5	light yellow	24,0 - 28,0	11,5	46	10	o. r.	o. r.	o. r.
903824	M50 x 1,5	anthracite	27,0 - 32,0	14,0	56	5	o. r.	o. r.	o. r.
903825	M50 x 1,5	light blue	29,0 - 34,0	14,0	56	5	o. r.	o. r.	o. r.
904295	M50 x 1,5	pink	32,0 - 36,0	14,0	56	5	o. r.	o. r.	o. r.

Continuation ►

UNI-DICHT-PA Cable gland



PG thread

Part no.	Size PG	Sealing insert colour	Cable Ø from / to mm	Thread length mm	Spanner size mm	Unit	Net EUR/100 items at a purchase of		
							up to 100	101 - 500	501 - 1000
903826	9	yellow	4,0 - 6,5	9,0	19	50	o. r.	o. r.	o. r.
903827	9	grey	5,0 - 8,0	9,0	19	50	o. r.	o. r.	o. r.
903828	9	black	6,5 - 9,5	9,0	19	50	o. r.	o. r.	o. r.
903829	11	yellow	4,0 - 6,5	9,0	22	50	o. r.	o. r.	o. r.
903830	11	grey	5,0 - 8,0	9,0	22	50	o. r.	o. r.	o. r.
903831	11	black	6,5 - 9,5	9,0	22	50	o. r.	o. r.	o. r.
903832	11	green	7,0 - 10,5	9,0	22	50	o. r.	o. r.	o. r.
903833	13,5	yellow	4,0 - 6,5	9,0	24	50	o. r.	o. r.	o. r.
903834	13,5	grey	5,0 - 8,0	9,0	24	50	o. r.	o. r.	o. r.
903835	13,5	black	6,5 - 9,5	9,0	24	50	o. r.	o. r.	o. r.
903836	13,5	green	7,0 - 10,5	9,0	24	50	o. r.	o. r.	o. r.
903837	13,5	red	9,0 - 13,0	9,0	24	50	o. r.	o. r.	o. r.
903838	16	yellow	4,0 - 6,5	9,0	27	50	o. r.	o. r.	o. r.
903839	16	grey	5,0 - 8,0	9,0	27	50	o. r.	o. r.	o. r.
903840	16	black	6,5 - 9,5	9,0	27	50	o. r.	o. r.	o. r.
903841	16	green	7,0 - 10,5	9,0	27	50	o. r.	o. r.	o. r.
903842	16	red	9,0 - 13,0	9,0	27	50	o. r.	o. r.	o. r.
903843	16	white	11,5 - 15,5	9,0	27	50	o. r.	o. r.	o. r.
903844	21	green	7,0 - 10,5	11,0	33	25	o. r.	o. r.	o. r.
903845	21	red	9,0 - 13,0	11,0	33	25	o. r.	o. r.	o. r.
903846	21	white	11,5 - 15,5	11,0	33	25	o. r.	o. r.	o. r.
903847	21	blue	14,0 - 18,0	11,0	33	25	o. r.	o. r.	o. r.
903848	21	brown	17,0 - 20,5	11,0	33	25	o. r.	o. r.	o. r.
903849	29	blue	14,0 - 18,0	11,0	43	10	o. r.	o. r.	o. r.
903850	29	brown	17,0 - 20,5	11,0	43	10	o. r.	o. r.	o. r.
903851	29	orange	20,0 - 25,0	11,0	43	10	o. r.	o. r.	o. r.
903852	29	light yellow	24,0 - 28,0	11,0	43	10	o. r.	o. r.	o. r.
903853	36	anthracite	27,0 - 32,0	14,0	53	5	o. r.	o. r.	o. r.
903854	36	light blue	29,0 - 34,0	14,0	53	5	o. r.	o. r.	o. r.
903855	36	pink	32,0 - 36,0	14,0	53	5	o. r.	o. r.	o. r.

Dimensions and specifications may be changed without prior notice.

o. r. = on request

UNI-DICHT-MFD-PA Cable gland



With multiple sealing inserts

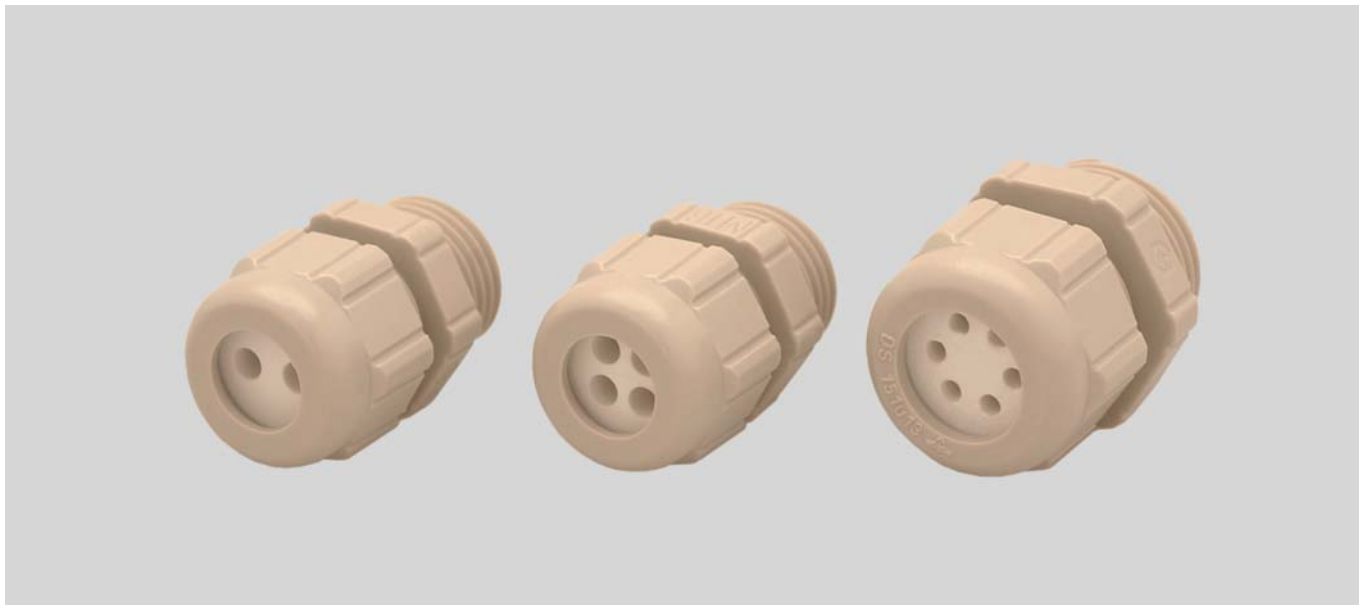

UNI-DICHT-MFD-PA

Plastic sealing gland with multiple TPE sealing inserts.

Application

- Plant and machine construction
- Robotics
- Automation technology
- Vehicle construction and shipbuilding
- Railway technology
- Installation technology
- Control cabinet construction

Material

Polyamide PA6-3
Seal: TPE

- halogen-free
- phosphor-free
- silicone-free
- cadmium-free

Properties

- Extensive cable sealing
- Easy to assemble

Note

Protection class IP 68, if the bore diameter in the sealing insert area is equal to the cable diameter.

Technical data

Protection class: IP 68

Temperature range: -20°C up to +100°C

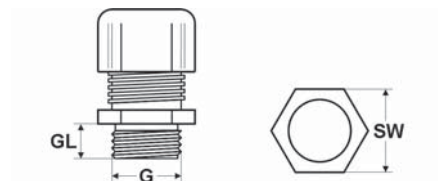

Dimensions

G Thread size
GL Thread length
SW Spanner size

Metric thread

Part no. grey RAL 7032	Size Metr.	Number holes x cable-Ø mm	Thread length mm	Spanner size mm	Unit	Net EUR/100 items at a purchase of		
						up to 100	101 - 500	501 - 1000
903856	M16 x 1,5	2 x 1,2	9,0	19	50	o. r.	o. r.	o. r.
903857	M16 x 1,5	2 x 3,0	9,0	19	50	o. r.	o. r.	o. r.
903858	M16 x 1,5	4 x 3,0	9,0	19	50	o. r.	o. r.	o. r.
903859	M16 x 1,5	2 x 4,0	9,0	19	50	o. r.	o. r.	o. r.
903860	M16 x 1,5	1 x 5,0	9,0	19	50	o. r.	o. r.	o. r.
903861	M20 x 1,5	6 x 2,0	9,0	24	50	o. r.	o. r.	o. r.
903862	M20 x 1,5	2 x 2,3	9,0	24	50	o. r.	o. r.	o. r.
903863	M20 x 1,5	6 x 2,5	9,0	24	50	o. r.	o. r.	o. r.
903864	M20 x 1,5	2 x 3,0	9,0	24	50	o. r.	o. r.	o. r.
903865	M20 x 1,5	3 x 3,0	9,0	24	50	o. r.	o. r.	o. r.
903866	M20 x 1,5	2 x 5,0	9,0	24	50	o. r.	o. r.	o. r.
903867	M25 x 1,5	7 x 2,0	9,0	29	50	o. r.	o. r.	o. r.
903868	M25 x 1,5	2 x 4,0	9,0	29	50	o. r.	o. r.	o. r.
903869	M25 x 1,5	4 x 4,0	9,0	29	50	o. r.	o. r.	o. r.
903870	M25 x 1,5	6 x 4,0	9,0	29	50	o. r.	o. r.	o. r.
903871	M25 x 1,5	2 x 6,0	9,0	29	50	o. r.	o. r.	o. r.
903872	M25 x 1,5	3 x 7,0	9,0	29	50	o. r.	o. r.	o. r.
903873	M32 x 1,5	21 x 2,0	11,0	38	25	o. r.	o. r.	o. r.
903874	M32 x 1,5	8 x 3,0	11,0	38	25	o. r.	o. r.	o. r.
903875	M32 x 1,5	6 x 4,0	11,0	38	25	o. r.	o. r.	o. r.
903876	M32 x 1,5	8 x 4,0	11,0	38	25	o. r.	o. r.	o. r.
903877	M32 x 1,5	4 x 5,0	11,0	38	25	o. r.	o. r.	o. r.
903878	M32 x 1,5	4 x 6,0	11,0	38	25	o. r.	o. r.	o. r.
903879	M32 x 1,5	6 x 6,5	11,0	38	25	o. r.	o. r.	o. r.
903880	M32 x 1,5	3 x 7,0	11,0	38	25	o. r.	o. r.	o. r.
903881	M32 x 1,5	4 x 8,0	11,0	38	25	o. r.	o. r.	o. r.
903882	M32 x 1,5	2 x 9,0	11,0	38	25	o. r.	o. r.	o. r.

Continuation ►

UNI-DICHT-MFD-PA Cable gland



With multiple sealing inserts

Metric thread

Part no. grey RAL 7032	Size Metr.	Number holes x cable-Ø mm	Thread length mm	Spanner size mm	Unit	Net EUR/ 100 items at a purchase of		
						up to 100	101 - 500	501 - 1000
903883	M40 x 1,5	6 x 6,0	11,5	46	10	o. r.	o. r.	o. r.
903884	M40 x 1,5	10 x 6,0	11,5	46	10	o. r.	o. r.	o. r.
903885	M40 x 1,5	4 x 6,5	11,5	46	10	o. r.	o. r.	o. r.
903886	M40 x 1,5	6 x 8,0	11,5	46	10	o. r.	o. r.	o. r.
903887	M40 x 1,5	4 x 9,0	11,5	46	10	o. r.	o. r.	o. r.
903888	M40 x 1,5	5 x 9,0	11,5	46	10	o. r.	o. r.	o. r.
903889	M40 x 1,5	5 x 10,0	11,5	46	10	o. r.	o. r.	o. r.
903890	M40 x 1,5	2 x 11,0	11,5	46	10	o. r.	o. r.	o. r.
903891	M50 x 1,5	15 x 5,0	14,0	55	5	o. r.	o. r.	o. r.
903892	M50 x 1,5	8 x 9,0	14,0	55	5	o. r.	o. r.	o. r.
903893	M50 x 1,5	3 x 10,0	14,0	55	5	o. r.	o. r.	o. r.
903894	M50 x 1,5	2 x 15,0	14,0	55	5	o. r.	o. r.	o. r.

PG thread

Part no. grey RAL 7032	Size PG	Number holes x cable-Ø mm	Thread length mm	Spanner size mm	Unit	Net EUR/ 100 items at a purchase of		
						up to 100	101 - 500	501 - 1000
903895	9	2 x 1,2	9,0	19	50	o. r.	o. r.	o. r.
903896	9	2 x 3,0	9,0	19	50	o. r.	o. r.	o. r.
903897	9	4 x 3,0	9,0	19	50	o. r.	o. r.	o. r.
903898	9	2 x 4,0	9,0	19	50	o. r.	o. r.	o. r.
903899	9	1 x 5,0	9,0	19	50	o. r.	o. r.	o. r.
903900	11	6 x 2,0	9,0	22	50	o. r.	o. r.	o. r.
903901	11	2 x 2,3	9,0	22	50	o. r.	o. r.	o. r.
903902	11	6 x 2,5	9,0	22	50	o. r.	o. r.	o. r.
903903	11	2 x 3,0	9,0	22	50	o. r.	o. r.	o. r.
903904	11	3 x 3,0	9,0	22	50	o. r.	o. r.	o. r.
903905	11	2 x 5,0	9,0	22	50	o. r.	o. r.	o. r.
903906	13,5	3 x 2,0	9,0	24	50	o. r.	o. r.	o. r.
903907	13,5	10 x 2,0	9,0	24	50	o. r.	o. r.	o. r.
903908	13,5	2 x 3,0	9,0	24	50	o. r.	o. r.	o. r.
903909	13,5	3 x 3,0	9,0	24	50	o. r.	o. r.	o. r.
903910	13,5	6 x 3,5	9,0	24	50	o. r.	o. r.	o. r.
903911	13,5	2 x 5,0	9,0	24	50	o. r.	o. r.	o. r.
903912	13,5	2 x 6,0	9,0	24	50	o. r.	o. r.	o. r.
903913	16	7 x 2,0	9,0	27	50	o. r.	o. r.	o. r.
903914	16	2 x 4,0	9,0	27	50	o. r.	o. r.	o. r.
903915	16	4 x 4,0	9,0	27	50	o. r.	o. r.	o. r.
903916	16	6 x 4,0	9,0	27	50	o. r.	o. r.	o. r.
903917	16	2 x 6,0	9,0	27	50	o. r.	o. r.	o. r.
903918	16	3 x 7,0	9,0	27	50	o. r.	o. r.	o. r.
903919	21	21 x 2,0	11,0	33	25	o. r.	o. r.	o. r.
903920	21	8 x 3,0	11,0	33	25	o. r.	o. r.	o. r.
903921	21	6 x 4,0	11,0	33	25	o. r.	o. r.	o. r.
903922	21	8 x 4,0	11,0	33	25	o. r.	o. r.	o. r.
903923	21	4 x 5,0	11,0	33	25	o. r.	o. r.	o. r.
903924	21	4 x 6,0	11,0	33	25	o. r.	o. r.	o. r.
903925	21	6 x 6,5	11,0	33	25	o. r.	o. r.	o. r.
903926	21	3 x 7,0	11,0	33	25	o. r.	o. r.	o. r.
903927	21	4 x 8,0	11,0	33	25	o. r.	o. r.	o. r.
903928	21	2 x 9,0	11,0	33	25	o. r.	o. r.	o. r.
903929	29	6 x 6,0	11,0	43	10	o. r.	o. r.	o. r.
903930	29	10 x 6,0	11,0	43	10	o. r.	o. r.	o. r.
903931	29	4 x 6,5	11,0	43	10	o. r.	o. r.	o. r.
903932	29	6 x 8,0	11,0	43	10	o. r.	o. r.	o. r.
903933	29	4 x 9,0	11,0	43	10	o. r.	o. r.	o. r.
903934	29	5 x 9,0	11,0	43	10	o. r.	o. r.	o. r.
903935	29	5 x 10,0	11,0	43	10	o. r.	o. r.	o. r.
903936	29	2 x 11,0	11,0	43	10	o. r.	o. r.	o. r.
903937	36	8 x 9,0	14,0	53	5	o. r.	o. r.	o. r.
903938	36	15 x 5,0	14,0	53	5	o. r.	o. r.	o. r.
903939	36	3 x 10,0	14,0	53	5	o. r.	o. r.	o. r.
903940	36	2 x 15,0	14,0	53	5	o. r.	o. r.	o. r.

Dimensions and specifications may be changed without prior notice.

o. r. = on request

UNI-DICHT-VK-PA Gland body



UNI-DICHT-VK-PA

Gland body made of polyamide for fitting with TPE sealing inserts.

Application

- Plant and machine construction
- Robotics
- Automation technology
- Vehicle construction and shipbuilding
- Railway technology
- Installation technology
- Control cabinet construction

Material

Polyamide PA6-3

Note

The gland body M20x1,5 part no. 903941 is suitable for PG 11 inserts; part no. 90831 is suitable for PG 13,5 inserts.

Technical data

Temperature range: -20°C up to +100°C

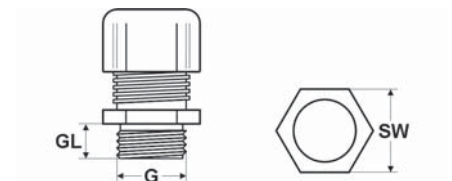

Dimensions

G Thread size
GL Thread length
SW Spanner size

Metric thread

Part no. grey RAL 7032	Size Metr.	Thread length mm	Spanner size mm	Unit	Net EUR/100 items at a purchase of		
					up to 100	101 - 500	501 - 1000
90829	M12 x 1,5	8,0	15	50	o. r.	o. r.	o. r.
90830	M16 x 1,5	9,0	19	50	o. r.	o. r.	o. r.
903941	M20 x 1,5	9,0	24	50	o. r.	o. r.	o. r.
90831	M20 x 1,5	9,0	24	50	o. r.	o. r.	o. r.
90832	M25 x 1,5	9,0	30	50	o. r.	o. r.	o. r.
90833	M32 x 1,5	11,0	36	25	o. r.	o. r.	o. r.
90834	M40 x 1,5	11,5	46	10	o. r.	o. r.	o. r.
90835	M50 x 1,5	14,0	56	5	o. r.	o. r.	o. r.

PG thread

Part no. grey RAL 7032	Size PG	Thread length mm	Spanner size mm	Unit	Net EUR/100 items at a purchase of		
					up to 100	101 - 500	501 - 1000
96043	9	9,0	19	50	o. r.	o. r.	o. r.
96044	11	9,0	22	50	o. r.	o. r.	o. r.
96045	13,5	9,0	24	50	o. r.	o. r.	o. r.
96046	16	9,0	27	50	o. r.	o. r.	o. r.
96047	21	11,0	33	25	o. r.	o. r.	o. r.
96048	29	11,0	43	10	o. r.	o. r.	o. r.
96049	36	14,0	53	5	o. r.	o. r.	o. r.

Dimensions and specifications may be changed without prior notice.

o. r. = on request

UNI-DICHT Sealing insert

Closed



UNI-DICHT sealing insert closed

Closed TPE-V sealing inserts which fit in UNI DICHT gland bodies - plastic or brass.

Application

- Plant and machine construction
- Robotics
- Automation technology
- Vehicle construction and shipbuilding
- Railway technology
- Installation technology
- Control cabinet construction

Material

TPE-V

- halogen-free
- phosphor-free
- silicone-free
- cadmium-free

Note

The UNI-DICHT sealing insert M20x1,5 (part no. 903944) can only be used with **UNI-DICHT-VK-PA** M20x1,5 (part no. 90831).
The UNI-DICHT sealing insert M20x1,5 (part no. 903945) can only be used with **UNI-DICHT-VK-MS** M20x1,5 (part no. 904213).

Technical data

Temperature range: -40°C up to +135°C

Part no.	Size PG	Size metric	Sealing insert colour	Cable Ø from / to mm	Unit	Net EUR/ 100 items at a purchase of		
						up to 100	101 - 500	501 - 1000
903942	9	M16 x 1,5	white	-	100	o. r.	o. r.	o. r.
903943	11	M20 x 1,5	white	-	100	o. r.	o. r.	o. r.
903944	-	M20 x 1,5	white/short	-	100	o. r.	o. r.	o. r.
903945	13,5	M20 x 1,5	white	-	100	o. r.	o. r.	o. r.
903946	16	M25 x 1,5	white	-	100	o. r.	o. r.	o. r.
903947	21	M32 x 1,5	white	-	50	o. r.	o. r.	o. r.
903948	29	M40 x 1,5	white	-	25	o. r.	o. r.	o. r.
903949	36	M50 x 1,5	white	-	10	o. r.	o. r.	o. r.
903950	42	-	white	-	10	o. r.	o. r.	o. r.
903951	48	M63 x 1,5	white	-	10	o. r.	o. r.	o. r.

Dimensions and specifications may be changed without prior notice.

o. r. = on request

UNI-DICHT Sealing insert

Standard

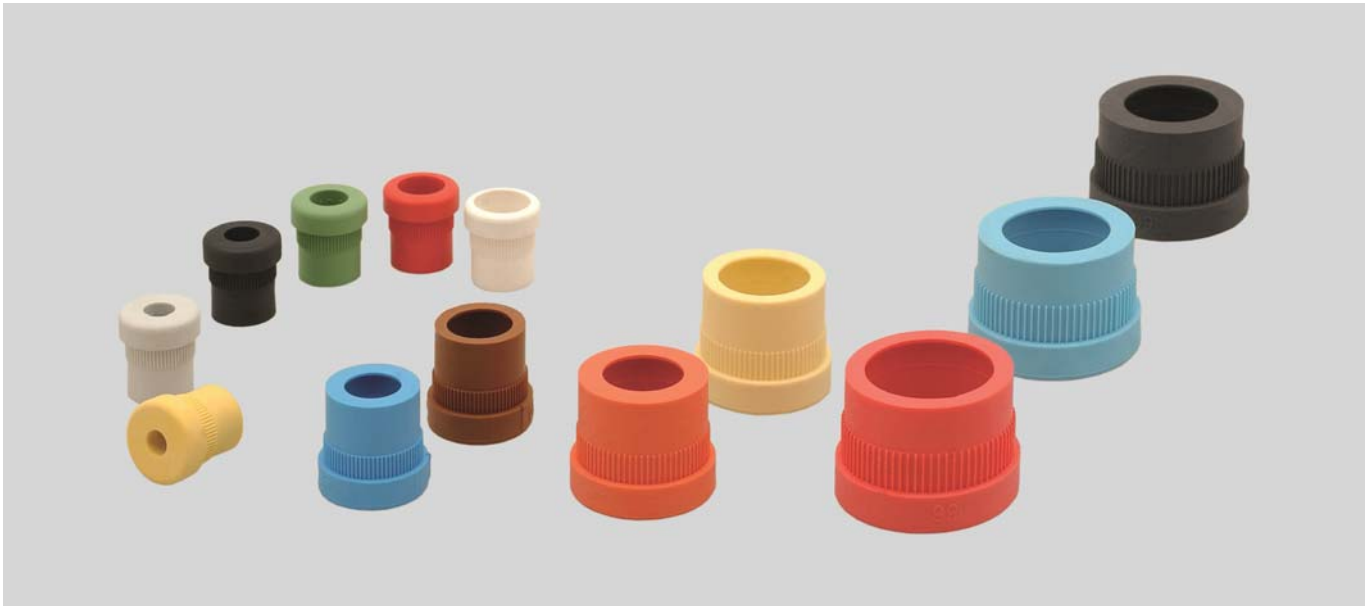

UNI-DICHT sealing insert standard

Colour coded TPE sealing insert for UNI DICHT gland bodies - polyamide or brass.

Application

- Plant and machine construction
- Robotics
- Automation technology
- Vehicle construction and shipbuilding
- Railway technology
- Installation technology
- Control cabinet construction

Material

TPE

- halogen-free
- phosphor-free
- silicone-free
- cadmium-free

Note

The UNI-DICHT sealing inserts M20x1,5 (part no. 903961 up to 903965) can only be used with **UNI-DICHT-VK-PA** M20x1,5 (part no. 90831).

The UNI-DICHT sealing inserts M20x1,5 (part no. 903966 up to 903970) can only be used with **UNI-DICHT-VK-MS** M20x1,5 (part no. 904213).

The UNI-DICHT sealing insert PG21 (part no. 903981) can only be used with

UNI-DICHT-VK-MS PG21 (part no. 904226).

The UNI-DICHT sealing insert M32x1,5 (part no. 903981) can only be used with **UNI-DICHT-VK-MS** M32x1,5 (part no. 904216).

Technical data

Temperature range: -40°C up to +130°C

Part no.	Size PG	Size metric	Sealing insert colour	Cable Ø from / to mm	Unit	Net EUR/ 100 items at a purchase of		
						up to 100	101 - 500	501 - 1000
903952	-	M12 x 1,5	yellow	4,0 - 6,5	50	o. r.	o. r.	o. r.
903953	7	-	yellow	4,0 - 6,5	50	o. r.	o. r.	o. r.
903954	9	M16 x 1,5	yellow	4,0 - 6,5	50	o. r.	o. r.	o. r.
903955	9	M16 x 1,5	grey	5,0 - 8,0	50	o. r.	o. r.	o. r.
903956	9	M16 x 1,5	black	6,5 - 9,5	50	o. r.	o. r.	o. r.
903957	11	M20 x 1,5	yellow	4,0 - 6,5	50	o. r.	o. r.	o. r.
903958	11	M20 x 1,5	grey	5,0 - 8,0	50	o. r.	o. r.	o. r.
903959	11	M20 x 1,5	black	6,5 - 9,5	50	o. r.	o. r.	o. r.
903960	11	M20 x 1,5	green	7,0 - 10,5	50	o. r.	o. r.	o. r.
903961	-	M20 x 1,5	yellow	4,0 - 6,5	50	o. r.	o. r.	o. r.
903962	-	M20 x 1,5	grey	5,0 - 8,0	50	o. r.	o. r.	o. r.
903963	-	M20 x 1,5	black	6,5 - 9,5	50	o. r.	o. r.	o. r.
903964	-	M20 x 1,5	green	7,0 - 10,5	50	o. r.	o. r.	o. r.
903965	-	M20 x 1,5	red	9,0 - 13,0	50	o. r.	o. r.	o. r.
903966	13,5	M20 x 1,5	yellow	4,0 - 6,5	50	o. r.	o. r.	o. r.
903967	13,5	M20 x 1,5	grey	5,0 - 8,0	50	o. r.	o. r.	o. r.
903968	13,5	M20 x 1,5	black	6,5 - 9,5	50	o. r.	o. r.	o. r.
903969	13,5	M20 x 1,5	green	7,0 - 10,5	50	o. r.	o. r.	o. r.
903970	13,5	M20 x 1,5	red	9,0 - 13,0	50	o. r.	o. r.	o. r.

Continuation ►

UNI-DICHT Sealing insert

Standard

Part no.	Size PG	Size metric	Sealing insert colour	Cable Ø from / to mm	Unit	Net EUR/ 100 items at a purchase of		
						up to 100	101 - 500	501 - 1000
903971	16	M25 x 1,5	yellow	4,0 - 6,5	50	o. r.	o. r.	o. r.
903972	16	M25 x 1,5	grey	5,0 - 8,0	50	o. r.	o. r.	o. r.
903973	16	M25 x 1,5	black	6,5 - 9,5	50	o. r.	o. r.	o. r.
903974	16	M25 x 1,5	green	7,0 - 10,5	50	o. r.	o. r.	o. r.
903975	16	M25 x 1,5	red	9,0 - 13,0	50	o. r.	o. r.	o. r.
903976	16	M25 x 1,5	white	11,5 - 15,5	50	o. r.	o. r.	o. r.
903977	21	M32 x 1,5	green	7,0 - 10,5	25	o. r.	o. r.	o. r.
903978	21	M32 x 1,5	red	9,0 - 13,0	25	o. r.	o. r.	o. r.
903979	21	M32 x 1,5	white	11,5 - 15,5	25	o. r.	o. r.	o. r.
903980	21	M32 x 1,5	blue	14,0 - 18,0	25	o. r.	o. r.	o. r.
903981	21	M32 x 1,5	brown	17,0 - 20,5	25	o. r.	o. r.	o. r.
903982	29	M40 x 1,5	white	11,5 - 15,5	10	o. r.	o. r.	o. r.
903983	29	M40 x 1,5	blue	14,0 - 18,0	10	o. r.	o. r.	o. r.
903984	29	M40 x 1,5	brown	17,0 - 20,5	10	o. r.	o. r.	o. r.
903985	29	M40 x 1,5	orange	20,0 - 25,0	10	o. r.	o. r.	o. r.
903986	29	M40 x 1,5	light yellow	24,0 - 28,0	10	o. r.	o. r.	o. r.
903987	36	M50 x 1,5	anthracite	27,0 - 32,0	10	o. r.	o. r.	o. r.
903988	36	M50 x 1,5	light blue	29,0 - 34,0	10	o. r.	o. r.	o. r.
903989	36	M50 x 1,5	pink	32,0 - 36,0	10	o. r.	o. r.	o. r.
903990	42	M50 x 1,5	white	36,0 - 40,0	5	o. r.	o. r.	o. r.
903991	48	M63 x 1,5	white	39,0 - 44,0	5	o. r.	o. r.	o. r.

Dimensions and specifications may be changed without prior notice.

o. r. = on request

■ CLASSIFICATION

UNI-DICHT SEALING INSERT/GLAND BODY

UNI-DICHT sealing insert

UNI-DICHT gland body

Part no.	Size PG	Size metric	Colour of the sealing inserts	Size PG		Size metric	
				Polyamide	Stainless steel	Polyamide	Stainless steel
903952	-	M12 x 1,5	yellow			90829 VK PA M12	904210 VK PA M12
903953	7	-	yellow		904220 VK PA M7		
903954	9	M12 x 1,5	yellow				
903955	9	M12 x 1,5	grey	96043 VK PA M9	904221 VK PA M9	90830 VK PA M16	904211 VK PA M16
903956	9	M12 x 1,5	black				
903957	11	M12 x 1,5	yellow				
903958	11	M12 x 1,5	grey				
903959	11	M12 x 1,5	black	96044 VK PA M11	904222 VK PA M11	96044 VK PA M11	
903960	11	M12 x 1,5	green				
903961	-	M12 x 1,5	yellow				
903962	-	M12 x 1,5	grey				
903963	-	M12 x 1,5	black			90831 VK PA M20	
903964	-	M12 x 1,5	green				
903965	-	M12 x 1,5	red				
903966	13.5	M12 x 1,5	yellow				
903967	13.5	M12 x 1,5	grey				
903968	13.5	M12 x 1,5	black	96045 VK PA M13.5	904223 VK PA M13.5		904223 VK PA M13.5
903969	13.5	M12 x 1,5	green				
903970	13.5	M12 x 1,5	red				
903971	16	M12 x 1,5	yellow				
903972	16	M12 x 1,5	grey				
903973	16	M12 x 1,5	black				
903974	16	M12 x 1,5	green	96046 VK PA M16	904224 VK PA M16	90832 VK PA M25	904214 VK PA M25
903975	16	M12 x 1,5	red				
903976	16	M12 x 1,5	white				
903977	21	M12 x 1,5	green				
903978	21	M12 x 1,5	red				
903979	21	M12 x 1,5	white	96047 VK PA M21	904222 VK PA M11	90833 VK PA M32	904210 VK PA M12
903980	21	M12 x 1,5	blue				
903981	21	M12 x 1,5	brown				904210 VK PA M12
903982	29	M12 x 1,5	white				
903983	29	M12 x 1,5	blue				
903984	29	M12 x 1,5	brown	96048 VK PA M29	904227 VK PA M29	90834 VK PA M40	904217 VK PA M40
903985	29	M12 x 1,5	orange				
903986	29	M12 x 1,5	light yellow				
903987	36	M12 x 1,5	anthracite				
903988	36	M12 x 1,5	light blue	96049 VK PA M36	904228 VK PA M36	90835 VK PA M50	904218 VK PA M50
903989	36	M12 x 1,5	pink				
903990	42	M12 x 1,5	white		904229 VK PA M42		
903991	48	M12 x 1,5	white		904230 VK PA M48		904219 VK PA M63

UNI-DICHT MFDE Multiple sealing insert



UNI-DICHT multiple sealing insert

Multiple TPE sealing insert which fit in UNI-DICHT gland bodies - polyamide or brass.

Application

- Plant and machine construction
- Robotics
- Automation technology
- Vehicle construction and shipbuilding
- Railway technology
- Installation technology
- Control cabinet construction

Material

TPE

- halogen-free
- phosphor-free
- silicone-free
- cadmium-free

Note

The UNI-DICHT sealing inserts M20x1,5 (part no. 904004 up to 904010) can only be used with UNI-DICHT gland body made of polyamide M20x1,5 (part no. 90831).

The UNI-DICHT sealing inserts M20x1,5 (part no. 904011 up to 904017) can only be used with **UNI-DICHT-VK-MS** M20x1,5 (Art.-Nr. 904213), **UNI-DICHT-VK-PA** PG13,5 (part no. 96045) and **UNI-DICHT-VK-MS** PG13,5 (part no. 904223).

Technical data

Temperature range: -40°C up to +130°C

Part no.	Size PG	Size metric	Insert colour	Number x Ø borehole mm	Unit	Net EUR/100 items at a purchase of		
						up to 100	101 - 500	501 - 1000
903994	9	M16 x 1,5	white	2 x 1,2	50	o. r.	o. r.	o. r.
903995	9	M16 x 1,5	white	2 x 3,0	50	o. r.	o. r.	o. r.
903996	9	M16 x 1,5	white	4 x 3,0	50	o. r.	o. r.	o. r.
903997	9	M16 x 1,5	white	2 x 4,0	50	o. r.	o. r.	o. r.
903998	9	M16 x 1,5	white	1 x 5,0	50	o. r.	o. r.	o. r.
903999	11	M20 x 1,5	white	6 x 2,0	50	o. r.	o. r.	o. r.
904000	11	M20 x 1,5	white	2 x 3,0	50	o. r.	o. r.	o. r.
904001	11	M20 x 1,5	white	3 x 3,0	50	o. r.	o. r.	o. r.
904002	11	M20 x 1,5	white	2 x 4,0	50	o. r.	o. r.	o. r.
904003	11	M20 x 1,5	white	2 x 5,0	50	o. r.	o. r.	o. r.
904004	-	M20 x 1,5	white	3 x 2,0	50	o. r.	o. r.	o. r.
904006	-	M20 x 1,5	white	2 x 3,0	50	o. r.	o. r.	o. r.
904007	-	M20 x 1,5	white	3 x 3,0	50	o. r.	o. r.	o. r.
904008	-	M20 x 1,5	white	3 x 4,0	50	o. r.	o. r.	o. r.
904009	-	M20 x 1,5	white	2 x 5,0	50	o. r.	o. r.	o. r.
904010	-	M20 x 1,5	white	2 x 6,0	50	o. r.	o. r.	o. r.
904011	13,5	M20 x 1,5	white	3 x 2,0	50	o. r.	o. r.	o. r.
904012	13,5	M20 x 1,5	white	10 x 2,0	50	o. r.	o. r.	o. r.
904013	13,5	M20 x 1,5	white	2 x 3,0	50	o. r.	o. r.	o. r.
904014	13,5	M20 x 1,5	white	3 x 3,0	50	o. r.	o. r.	o. r.
904015	13,5	M20 x 1,5	white	3 x 4,0	50	o. r.	o. r.	o. r.
904016	13,5	M20 x 1,5	white	2 x 5,0	50	o. r.	o. r.	o. r.
904017	13,5	M20 x 1,5	white	2 x 6,0	50	o. r.	o. r.	o. r.

Continuation ►

UNI-DICHT MFDE Multiple sealing insert

Part no.	Size PG	Size metric	Insert colour	Number x Ø borehole mm	Unit	Net EUR/100 items at a purchase of		
						up to 100	101 - 500	501 - 1000
904018	16	M25 x 1,5	white	7 x 2,0	50	o. r.	o. r.	o. r.
904019	16	M25 x 1,5	white	3 x 3,0	50	o. r.	o. r.	o. r.
904020	16	M25 x 1,5	white	2 x 4,0	50	o. r.	o. r.	o. r.
904021	16	M25 x 1,5	white	4 x 4,0	50	o. r.	o. r.	o. r.
904022	16	M25 x 1,5	white	6 x 4,0	50	o. r.	o. r.	o. r.
904023	16	M25 x 1,5	white	2 x 6,0	50	o. r.	o. r.	o. r.
904024	16	M25 x 1,5	white	3 x 6,0	50	o. r.	o. r.	o. r.
904025	16	M25 x 1,5	white	4 x 6,0	50	o. r.	o. r.	o. r.
904026	16	M25 x 1,5	white	3 x 7,0	50	o. r.	o. r.	o. r.
904027	16	M25 x 1,5	white	2 x 8,0	50	o. r.	o. r.	o. r.
904028	21	M32 x 1,5	white	21 x 2,0	50	o. r.	o. r.	o. r.
904029	21	M32 x 1,5	white	8 x 3,0	50	o. r.	o. r.	o. r.
904030	21	M32 x 1,5	white	6 x 4,0	50	o. r.	o. r.	o. r.
904031	21	M32 x 1,5	white	8 x 4,0	50	o. r.	o. r.	o. r.
904032	21	M32 x 1,5	white	4 x 5,0	50	o. r.	o. r.	o. r.
904033	21	M32 x 1,5	white	8 x 5,0	50	o. r.	o. r.	o. r.
904034	21	M32 x 1,5	white	6 x 5,5	50	o. r.	o. r.	o. r.
904035	21	M32 x 1,5	white	4 x 6,0	50	o. r.	o. r.	o. r.
904036	21	M32 x 1,5	white	4 x 6,5	50	o. r.	o. r.	o. r.
904037	21	M32 x 1,5	white	6 x 6,5	50	o. r.	o. r.	o. r.
904038	21	M32 x 1,5	white	3 x 7,0	50	o. r.	o. r.	o. r.
904039	21	M32 x 1,5	white	2 x 8,0	50	o. r.	o. r.	o. r.
904040	21	M32 x 1,5	white	4 x 8,0	50	o. r.	o. r.	o. r.
904041	21	M32 x 1,5	white	2 x 9,0	50	o. r.	o. r.	o. r.
904042	21	M32 x 1,5	white	3 x 9,0	50	o. r.	o. r.	o. r.
904043	29	M40 x 1,5	white	6 x 6,0	25	o. r.	o. r.	o. r.
904044	29	M40 x 1,5	white	10 x 6,0	25	o. r.	o. r.	o. r.
904045	29	M40 x 1,5	white	4 x 6,5	25	o. r.	o. r.	o. r.
904046	29	M40 x 1,5	white	7 x 7,0	25	o. r.	o. r.	o. r.
904047	29	M40 x 1,5	white	6 x 8,0	25	o. r.	o. r.	o. r.
904048	29	M40 x 1,5	white	4 x 9,0	25	o. r.	o. r.	o. r.
904049	29	M40 x 1,5	white	5 x 9,0	25	o. r.	o. r.	o. r.
904050	29	M40 x 1,5	white	5 x 10,0	25	o. r.	o. r.	o. r.
904051	29	M40 x 1,5	white	2 x 11,0	25	o. r.	o. r.	o. r.
904052	29	M40 x 1,5	white	3 x 11,0	25	o. r.	o. r.	o. r.
904053	29	M40 x 1,5	white	2 x 13,0	25	o. r.	o. r.	o. r.
904054	36	M50 x 1,5	white	15 x 5,0	10	o. r.	o. r.	o. r.
904055	36	M50 x 1,5	white	13 x 7,0	10	o. r.	o. r.	o. r.
904056	36	M50 x 1,5	white	7 x 9,0	10	o. r.	o. r.	o. r.
904057	36	M50 x 1,5	white	8 x 9,0	10	o. r.	o. r.	o. r.
904058	36	M50 x 1,5	white	3 x 10,0	10	o. r.	o. r.	o. r.
904059	36	M50 x 1,5	white	4 x 13,0	10	o. r.	o. r.	o. r.
904060	36	M50 x 1,5	white	2 x 15,0	10	o. r.	o. r.	o. r.

Dimensions and specifications may be changed without prior notice.

o. r. = on request

Matching accessory



Sealing plug

For not assigned penetrations.

refer to page 33

UNI-DICHT-ASI-PA Cable gland



Profile fits to ASI-bus cable



UNI-DICHT-ASI-PA

Plastic sealing gland with inserts for ASI BUS cables.

Application

- Plant and machine construction
- Robotics
- Automation technology
- Installation technology
- Control cabinet construction

Material

Polyamide
Seal: TPE-V

- halogen-free
- phosphor-free
- silicone-free
- cadmium-free

Properties

- Large-areas cable sealing
- Easy to assemble

Technical data

Protection class: IP 68 - 10 bar

Temperature range: -20°C up to +100°C

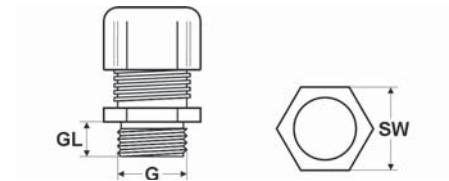

Dimensions

- G Thread size
- GL Thread length
- SW Spanner size

Metric thread

Part no.	Size Metr.	Sealing insert colour	Cable Ø from / to mm	Thread length mm	Spanner size mm	Unit	Net EUR/100 items at a purchase of		
							up to 100	101 - 500	501 - 1000
903796	M20 x 1,5	grey, left	-	9,0	24	50	o. r.	o. r.	o. r.
903797	M20 x 1,5	grey, right	-	9,0	24	50	o. r.	o. r.	o. r.

PG thread

Part no.	Size PG	Sealing insert colour	Cable Ø from / to mm	Thread length mm	Spanner size mm	Unit	Net EUR/100 items at a purchase of		
							up to 100	101 - 500	501 - 1000
903798	13,5	grey, left	-	9,0	24	50	o. r.	o. r.	o. r.
903799	13,5	grey, right	-	9,0	24	50	o. r.	o. r.	o. r.

Dimensions and specifications may be changed without prior notice.

o. r. = on request

UNI-DICHT Sealing insert

Profile fits to ASI-bus cable



UNI-DICHT Sealing insert ASI

TPE sealing insert for fitting in UNI DICHT gland bodies - plastic or brass. Profile fits into ASI bus cable.

Application

- Plant and machine construction
- Robotics
- Automation technology
- Installation technology
- Control cabinet construction

Material

TPE-V

- halogen-free
- phosphor-free
- silicone-free
- cadmium-free

Properties

- Large-area cable sealing
- Easy to assemble

Note

The UNI-DICHT sealing inserts ASI (part nos. 905910 and 905911) can be used with **UNI-DICHT-VK-PA** M20x1,5 (part no. 90831).
The UNI-DICHT sealing inserts ASI (part nos. 903992 and 903993) can be used with **UNI-DICHT-VK-MS** M20x1,5 (part no. 904213) and **UNI-DICHT-VK-PA/MS** PG13,5 (part no. 96045 and 904223).

Technical data

Temperature range: -20°C up to +100°C

Part no.	Size PG	Size metric	Sealing insert colour	Cable Ø from / to mm	Unit	Net EUR/100 items at a purchase of		
						up to 100	101 - 500	501 - 1000
903992	13,5	M20 x 1,5	grey, left	-	50	o. r.	o. r.	o. r.
903993	13,5	M20 x 1,5	grey, right	-	50	o. r.	o. r.	o. r.
905910	-	M20 x 1,5	grey, left	-	50	o. r.	o. r.	o. r.
905911	-	M20 x 1,5	grey, right	-	50	o. r.	o. r.	o. r.

Dimensions and specifications may be changed without prior notice.

o. r. = on request

STK-PA Cable gland according to DIN



STK-PA

Polyamide cable gland according to DIN 46320.

Application

- Plant and machine construction
- Robotics
- Automation technology
- Vehicle construction and shipbuilding
- Railway technology
- Installation technology
- Control cabinet construction

Material

Polyamide
Seal: NR

- halogen-free
- phosphor-free
- silicone-free
- cadmium-free

Technical data

Protection class: IP 54

Temperature range: -30°C up to +80°C



Dimensions

G Thread size
GL Thread length
SW Spanner size

Metric thread

Part no. light grey RAL 7035	Size Metr.	Cable Ø from / to mm	Thread length mm	Spanner size mm	Unit	Net EUR/ 100 items at a purchase of		
						up to 100	101 - 500	501 - 1000
92819	M12 x 1,5	5,0 - 8,0	11,0	19	50	o. r.	o. r.	o. r.
92820	M16 x 1,5	7,0 - 9,0	11,0	19	50	o. r.	o. r.	o. r.
92821	M20 x 1,5	8,0 - 12,0	11,0	24	50	o. r.	o. r.	o. r.
92823	M25 x 1,5	11,0 - 14,0	11,0	27	50	o. r.	o. r.	o. r.
92824	M25 x 1,5	13,0 - 17,0	11,0	32	50	o. r.	o. r.	o. r.
92825	M32 x 1,5	18,0 - 26,0	11,0	42	10	o. r.	o. r.	o. r.
92826	M40 x 1,5	23,0 - 26,0	11,0	42	10	o. r.	o. r.	o. r.
92827	M50 x 1,5	25,0 - 33,0	11,0	53	10	o. r.	o. r.	o. r.
92828	M50 x 1,5	32,0 - 40,0	11,0	60	5	o. r.	o. r.	o. r.
92829	M63 x 1,5	38,0 - 44,0	11,0	65	5	o. r.	o. r.	o. r.

PG thread

Part no. light grey RAL 7035	Size PG	Cable Ø from / to mm	Thread length mm	Spanner size mm	Unit	Net EUR/ 100 items at a purchase of		
						up to 100	101 - 500	501 - 1000
90559	7	3,0 - 6,0	8,0	15	50	o. r.	o. r.	o. r.
90560	9	4,5 - 7,0	8,0	19	50	o. r.	o. r.	o. r.
90561	11	6,0 - 9,0	8,0	22	50	o. r.	o. r.	o. r.
90562	13,5	9,0 - 12,0	9,0	24	50	o. r.	o. r.	o. r.
90563	16	11,0 - 14,0	10,0	27	50	o. r.	o. r.	o. r.
90564	21	14,0 - 18,0	11,0	33	25	o. r.	o. r.	o. r.
90565	29	18,0 - 25,0	11,0	42	25	o. r.	o. r.	o. r.
90566	36	25,0 - 32,0	13,0	53	10	o. r.	o. r.	o. r.
90567	42	30,0 - 38,0	13,0	60 / 55	5	o. r.	o. r.	o. r.
90568	48	34,0 - 42,0	14,0	65 / 60	5	o. r.	o. r.	o. r.

Dimensions and specifications may be changed without prior notice.

o. r. = on request

STK-PA Cable gland

With incision sealing ring



STK-PA with incision ring

Polyamide cable gland according to DIN 46320 with incision sealing ring.

Application

- Plant and machine construction
- Robotics
- Automation technology
- Vehicle construction and shipbuilding
- Railway technology
- Installation technology
- Control cabinet construction

Material

Polyamide
Seal: NBR

- halogen-free
- phosphor-free
- silicone-free
- cadmium-free

Note

Protection classification IP 65 with an additional O-ring on the external thread.

Technical data

Protection class: IP 54

Temperature range: -20°C up to +60°C



Dimensions

G Thread size
GL Thread length
SW Spanner size

PG thread

Part no. light grey RAL 7035	Size PG	Cable Ø from / to mm	Thread length mm	Spanner size mm	Unit	Net EUR/100 items at a purchase of		
						up to 100	101 - 500	501 - 1000
904231	9	4,0 - 10,0	8,0	19 / 16	50	o. r.	o. r.	o. r.
904232	11	6,5 - 12,0	8,0	22 / 19	50	o. r.	o. r.	o. r.
904233	13,5	6,5 - 13,5	9,0	24 / 21	50	o. r.	o. r.	o. r.
904234	16	6,5 - 16,0	10,0	27 / 23	50	o. r.	o. r.	o. r.
904235	21	9,0 - 20,0	11,0	33 / 30	50	o. r.	o. r.	o. r.
904236	29	17,0 - 28,0	11,0	42 / 40	25	o. r.	o. r.	o. r.
904237	36	23,0 - 34,0	13,0	53 / 50	10	o. r.	o. r.	o. r.
904238	42	29,0 - 40,0	13,0	60 / 55	5	o. r.	o. r.	o. r.
904239	48	35,0 - 46,0	14,0	65 / 60	5	o. r.	o. r.	o. r.

Dimensions and specifications may be changed without prior notice.

o. r. = on request

STK-F Flat cable gland



STK-F

Plastic flat cable gland.

Application

- Plant and machine construction
- Robotics
- Automation technology
- Vehicle construction and shipbuilding
- Railway technology
- Installation technology
- Control cabinet construction

Material

Polyamide
Seal: TPE
Thrust washers: Galvanized steel

- halogen-free
- phosphor-free
- silicone-free
- cadmium-free

Note

Protection classification IP 65 with an additional O-ring on the external thread.

Technical data

Protection class: IP 54

Temperature range: -30°C up to +80°C

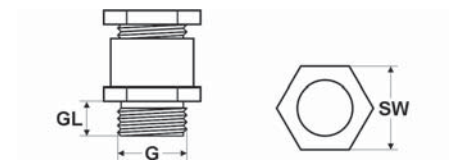

Dimensions

G Thread size
GL Thread length
SW Spanner size

Metric thread

Part no. light grey RAL 7035	Size Metr.	Cable thickness from / to mm	Cable width from / to mm	Thread length mm	Spanner size mm	Unit	Net EUR/100 items at a purchase of		
							up to 100	101 - 500	501 - 1000
904996	M25 x 1,5	3,0 - 8,0	9,0 - 21,0	11,0	32	50	o. r.	o. r.	o. r.
904997	M32 x 1,5	4,0 - 11,0	11,0 - 27,0	11,0	42	50	o. r.	o. r.	o. r.
905067	M40 x 1,5	4,0 - 11,0	11,0 - 27,0	11,0	42	20	o. r.	o. r.	o. r.
904998	M50 x 1,5	4,0 - 11,0	24,0 - 34,0	11,0	60	20	o. r.	o. r.	o. r.
905068	M63 x 1,5	5,0 - 12,0	34,0 - 50,0	11,0	65	5	o. r.	o. r.	o. r.

Dimensions and specifications may be changed without prior notice.

o. r. = on request

WN Self-sealing grommet

Closed



WN closed

Self-sealing grommet with flexible plastic lead-through diaphragm for simple cable inlet.

Application

- Plant and machine construction
- Robotics
- Automation technology
- Vehicle construction and shipbuilding
- Railway technology
- Installation technology
- Control cabinet construction

Material

Polyethylene

- halogen-free

Note

Open grommets available on request.

Technical data

Protection class: IP 54

Temperature range: -20°C up to +70°C

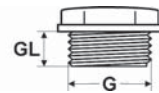

Dimensions

G Thread size

GL Thread length

Metric thread

Part no.	Size Metr.	Cable Ø from / to mm	Thread length mm	Unit	Net EUR/100 items at a purchase of		
					up to 100	101 - 500	501 - 1000
94120	M12 x 1,5	3,0 - 5,0	10,0	100	o. r.	o. r.	o. r.
94121	M16 x 1,5	5,0 - 10,0	10,0	100	o. r.	o. r.	o. r.
94122	M20 x 1,5	8,0 - 13,5	12,0	100	o. r.	o. r.	o. r.
94123	M25 x 1,5	9,0 - 16,0	12,0	100	o. r.	o. r.	o. r.
94124	M32 x 1,5	11,0 - 22,0	14,0	50	o. r.	o. r.	o. r.
94125	M40 x 1,5	17,0 - 24,0	16,0	25	o. r.	o. r.	o. r.
94126	M50 x 1,5	22,0 - 35,0	18,0	10	o. r.	o. r.	o. r.
94127	M63 x 1,5	24,0 - 43,0	20,0	10	o. r.	o. r.	o. r.

PG thread

Part no.	Size PG	Cable Ø from / to mm	Thread length mm	Unit	Net EUR/100 items at a purchase of		
					up to 100	101 - 500	501 - 1000
90116	9	6,0 - 8,0	12,0	100	o. r.	o. r.	o. r.
90117	11	7,0 - 10,0	14,0	100	o. r.	o. r.	o. r.
90118	13,5	9,0 - 12,0	17,0	100	o. r.	o. r.	o. r.
90119	16	9,0 - 14,0	19,0	100	o. r.	o. r.	o. r.
90120	21	11,0 - 17,0	24,0	50	o. r.	o. r.	o. r.

Dimensions and specifications may be changed without prior notice.

o. r. = on request

Adapter PA



Adapter PA

Adapter made of polyamide for thread adjustment from metric to PG.

Application

- Plant and machine construction
- Automation technology
- Vehicle construction and shipbuilding
- Installation technology
- Control cabinet construction

Material

Polyamide

Colour: light grey
RAL: 7035

- halogen-free
- phosphor-free
- silicone-free

Note

Colour black available on request.

Technical data

Temperature range: -40°C up to +100°C



Dimensions

G Thread size outside
IG Thread size inside

From metric to PG

Part no.	Size metr. outside	Size PG inside	Unit	Net EUR/100 items at a purchase of		
				up to 100	101 - 500	501 - 1000
93670	M12 x 1,5	7	100	o. r.	o. r.	o. r.
93671	M12 x 1,5	9	100	o. r.	o. r.	o. r.
93672	M16 x 1,5	9	100	o. r.	o. r.	o. r.
93673	M20 x 1,5	11	100	o. r.	o. r.	o. r.
93674	M20 x 1,5	13,5	100	o. r.	o. r.	o. r.
93675	M20 x 1,5	16	100	o. r.	o. r.	o. r.
93676	M25 x 1,5	16	50	o. r.	o. r.	o. r.
93677	M25 x 1,5	21	50	o. r.	o. r.	o. r.
93678	M32 x 1,5	29	25	o. r.	o. r.	o. r.
93679	M40 x 1,5	29	10	o. r.	o. r.	o. r.
93680	M50 x 1,5	36	10	o. r.	o. r.	o. r.
93681	M50 x 1,5	42	10	o. r.	o. r.	o. r.
93682	M63 x 1,5	48	10	o. r.	o. r.	o. r.

From PG to metric

Part no.	Size PG outside	Size metr. inside	Unit	Net EUR/100 items at a purchase of		
				up to 100	101 - 500	501 - 1000
93650	7	M12 x 1,5	100	o. r.	o. r.	o. r.
93651	7	M16 x 1,5	100	o. r.	o. r.	o. r.
93652	9	M12 x 1,5	100	o. r.	o. r.	o. r.
93653	9	M16 x 1,5	100	o. r.	o. r.	o. r.
93654	9	M20 x 1,5	100	o. r.	o. r.	o. r.
93655	11	M16 x 1,5	100	o. r.	o. r.	o. r.
93656	11	M20 x 1,5	100	o. r.	o. r.	o. r.
93657	13,5	M16 x 1,5	100	o. r.	o. r.	o. r.
93658	13,5	M20 x 1,5	100	o. r.	o. r.	o. r.
93659	13,5	M25 x 1,5	100	o. r.	o. r.	o. r.
93660	16	M20 x 1,5	100	o. r.	o. r.	o. r.
93661	16	M25 x 1,5	50	o. r.	o. r.	o. r.
93662	21	M25 x 1,5	50	o. r.	o. r.	o. r.
93663	21	M32 x 1,5	50	o. r.	o. r.	o. r.
93664	29	M32 x 1,5	50	o. r.	o. r.	o. r.
93665	29	M40 x 1,5	50	o. r.	o. r.	o. r.

Dimensions and specifications may be changed without prior notice.

o. r. = on request

EW-PA Extender



EW-PA

Extender made of polyamide.
Transition from small to large thread.

Material

Polyamide

Colour: light grey
RAL: 7035

- halogen-free
- phosphor-free
- silicone-free
- cadmium-free

Note

Colour black available on request.

Technical data

Temperature range: -40°C up to +100°C

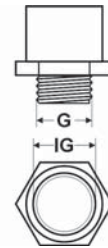

Dimensions

G Thread size outside
IG Thread size inside

From metric to metric

Part no.	Size metr. outside	Size metr. inside	Unit	Net EUR/100 items at a purchase of		
				up to 100	101 - 500	501 - 1000
98585	M12 x 1,5	M16 x 1,5	100	o. r.	o. r.	o. r.
98586	M16 x 1,5	M20 x 1,5	100	o. r.	o. r.	o. r.
95099	M20 x 1,5	M25 x 1,5	100	o. r.	o. r.	o. r.
98587	M25 x 1,5	M32 x 1,5	50	o. r.	o. r.	o. r.
98588	M32 x 1,5	M40 x 1,5	50	o. r.	o. r.	o. r.
98589	M40 x 1,5	M50 x 1,5	25	o. r.	o. r.	o. r.

From PG to PG

Part no.	Size PG outside	Size PG inside	Unit	Net EUR/100 items at a purchase of		
				up to 100	101 - 500	501 - 1000
90076	7	9	100	o. r.	o. r.	o. r.
90077	9	11	100	o. r.	o. r.	o. r.
90078	11	13,5	100	o. r.	o. r.	o. r.
96618	11	16	100	o. r.	o. r.	o. r.
90079	13,5	16	100	o. r.	o. r.	o. r.
90080	16	21	50	o. r.	o. r.	o. r.
90081	21	29	25	o. r.	o. r.	o. r.
90082	29	36	20	o. r.	o. r.	o. r.
90083	36	42	10	o. r.	o. r.	o. r.
90084	42	48	5	o. r.	o. r.	o. r.

Dimensions and specifications may be changed without prior notice.

o. r. = on request

RE-PA Reducer



RE-PA

Reducer made of polyamide.
Transition from large to small thread.

Application

- Plant and machine construction
- Robotics
- Automation technology
- Vehicle construction and shipbuilding
- Railway technology
- Installation technology
- Control cabinet construction

Material

Polyamide

Colour: light grey
RAL: 7035

- halogen-free
- phosphor-free
- silicone-free

Note

Black on request.

Technical data

Temperature range: -30°C up to +100°C

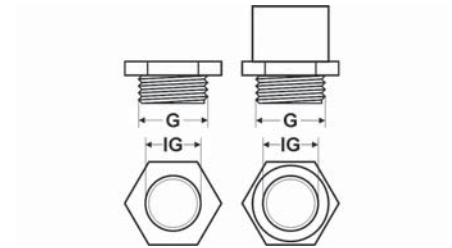

Dimensions

G Thread size outside
IG Thread size inside

From metric to metric

Part no.	Size metr. outside	Size metr. inside	Unit	Net EUR/100 items at a purchase of		
				up to 100	101 - 500	501 - 1000
97829	M20 x 1,5	M12 x 1,5	100	o. r.	o. r.	o. r.
97830	M20 x 1,5	M16 x 1,5	100	o. r.	o. r.	o. r.
97831	M25 x 1,5	M12 x 1,5	100	o. r.	o. r.	o. r.
97832	M25 x 1,5	M16 x 1,5	100	o. r.	o. r.	o. r.
97833	M25 x 1,5	M20 x 1,5	100	o. r.	o. r.	o. r.
97834	M32 x 1,5	M12 x 1,5	50	o. r.	o. r.	o. r.
97835	M32 x 1,5	M16 x 1,5	50	o. r.	o. r.	o. r.
97836	M32 x 1,5	M20 x 1,5	50	o. r.	o. r.	o. r.
97837	M32 x 1,5	M25 x 1,5	50	o. r.	o. r.	o. r.
97838	M40 x 1,5	M16 x 1,5	50	o. r.	o. r.	o. r.
97839	M40 x 1,5	M20 x 1,5	50	o. r.	o. r.	o. r.
97840	M40 x 1,5	M25 x 1,5	50	o. r.	o. r.	o. r.
97841	M40 x 1,5	M32 x 1,5	50	o. r.	o. r.	o. r.
97842	M50 x 1,5	M20 x 1,5	25	o. r.	o. r.	o. r.
97843	M50 x 1,5	M25 x 1,5	25	o. r.	o. r.	o. r.
97844	M50 x 1,5	M32 x 1,5	25	o. r.	o. r.	o. r.
97845	M50 x 1,5	M40 x 1,5	25	o. r.	o. r.	o. r.
97846	M63 x 1,5	M25 x 1,5	25	o. r.	o. r.	o. r.
97847	M63 x 1,5	M32 x 1,5	25	o. r.	o. r.	o. r.
97848	M63 x 1,5	M40 x 1,5	25	o. r.	o. r.	o. r.
97849	M63 x 1,5	M50 x 1,5	25	o. r.	o. r.	o. r.

Continuation ►

RE-PA Reducer

From PG to PG

Part no.	Size PG outside	Size PG inside	Unit	Net EUR/ 100 items at a purchase of		
				up to 100	101 - 500	501 - 1000
96187	11	7	100	o. r.	o. r.	o. r.
96189	13,5	7	100	o. r.	o. r.	o. r.
90069	13,5	9	100	o. r.	o. r.	o. r.
90070	16	9	100	o. r.	o. r.	o. r.
90071	16	11	100	o. r.	o. r.	o. r.
96192	21	11	100	o. r.	o. r.	o. r.
90072	21	13,5	100	o. r.	o. r.	o. r.
90073	21	16	100	o. r.	o. r.	o. r.
97007	29	13,5	50	o. r.	o. r.	o. r.
96193	29	16	50	o. r.	o. r.	o. r.
90074	29	21	50	o. r.	o. r.	o. r.
97008	36	16	50	o. r.	o. r.	o. r.
97009	36	21	50	o. r.	o. r.	o. r.
90075	36	29	50	o. r.	o. r.	o. r.
97010	42	21	25	o. r.	o. r.	o. r.
97011	42	29	25	o. r.	o. r.	o. r.
96194	42	36	25	o. r.	o. r.	o. r.
97012	48	29	25	o. r.	o. r.	o. r.
97013	48	36	25	o. r.	o. r.	o. r.
96195	48	42	25	o. r.	o. r.	o. r.

From PG to PG - high-profile design

Part no.	Size PG outside	Size PG inside	Unit	Net EUR/ 100 items at a purchase of		
				up to 100	101 - 500	501 - 1000
96186	9	7	100	o. r.	o. r.	o. r.
96188	11	9	100	o. r.	o. r.	o. r.
96190	13,5	11	100	o. r.	o. r.	o. r.
96191	16	13,5	100	o. r.	o. r.	o. r.

Dimensions and specifications may be changed without prior notice.

o. r. = on request

KMK-PA-MB Counternut with collar



KMK-PA-MB

Counternut made of polyamide.
The counternut with collar has a bigger sealing area - sealing with an additional O-ring will be simplified.

Application

- Plant and machine construction
- Automation technology
- Vehicle construction and shipbuilding
- Installation technology
- Control cabinet construction

Material

Polyamide PA 6

- halogen-free
- phosphor-free
- silicone-free
- cadmium-free

Technical data

Temperature range: -40°C up to +100°C

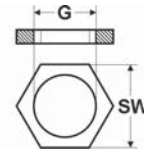

Dimensions

G Thread size inside
SW Spanner size

Metric thread – female

Part no. light grey RAL 7035	Part no. dark grey RAL 7001	Part no. black RAL 9005	Size Metr.	Spanner size mm	Unit	Net EUR/ 100 items at a purchase of		
						up to 100	101 - 500	501 - 1000
97816	94260	98163	M12 x 1,5	18	100	o. r.	o. r.	o. r.
97817	94261	98164	M16 x 1,5	22	100	o. r.	o. r.	o. r.
97818	94262	98165	M20 x 1,5	26	100	o. r.	o. r.	o. r.
97819	94263	98166	M25 x 1,5	32	100	o. r.	o. r.	o. r.
97820	94264	98167	M32 x 1,5	41	100	o. r.	o. r.	o. r.
97821	94265	98168	M40 x 1,5	50	50	o. r.	o. r.	o. r.
97822	94266	98169	M50 x 1,5	60	50	o. r.	o. r.	o. r.
97823	94267	98170	M63 x 1,5	75	25	o. r.	o. r.	o. r.

PG thread – female

Part no. light grey RAL 7035	Part no. dark grey RAL 7001	Part no. black RAL 9005	Size PG	Spanner size mm	Unit	Net EUR/ 100 items at a purchase of		
						up to 100	101 - 500	501 - 1000
90710	94250	96458	7	19	100	o. r.	o. r.	o. r.
90711	94251	96228	9	22	100	o. r.	o. r.	o. r.
90712	94252	96459	11	24	100	o. r.	o. r.	o. r.
90713	94253	96460	13,5	27	100	o. r.	o. r.	o. r.
90714	94254	96461	16	30	100	o. r.	o. r.	o. r.
90715	94255	96176	21	36	100	o. r.	o. r.	o. r.
90716	94256	96177	29	46	50	o. r.	o. r.	o. r.
90717	94257	96462	36	60	25	o. r.	o. r.	o. r.
90718	94258	96463	42	65	25	o. r.	o. r.	o. r.
90719	94259	96464	48	70	25	o. r.	o. r.	o. r.

NPT thread – female

Part no. light grey RAL 7035	Part no. dark grey RAL 7001	Part no. black RAL 9005	Size NPT	Spanner size mm	Unit	Net EUR/ 100 items at a purchase of		
						up to 100	101 - 500	501 - 1000
97317	90870	90875	3/8"	22	100	o. r.	o. r.	o. r.
97316	90871	90876	1/2"	27	100	o. r.	o. r.	o. r.
97315	90872	90877	3/4"	33	100	o. r.	o. r.	o. r.
98366	90873	90878	1"	47	50	o. r.	o. r.	o. r.

Dimensions and specifications may be changed without prior notice.

o. r. = on request

KMK-PA-OB Counternut without collar



KMK-PA-OB

Locknut made of polyamide without collar.

Material

Polyamide PA 6

Technical data

Temperature range: -40°C up to +100°C

Application

- Plant and machine construction
- Robotics
- Automation technology
- Vehicle construction and shipbuilding
- Railway technology
- Installation technology
- Control cabinet construction

- halogen-free
- phosphor-free
- silicone-free
- cadmium-free

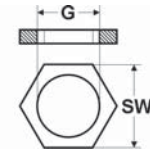

Dimensions

G Thread size inside
SW Spanner size

Metric thread – female

Part no. light grey RAL 7035	Part no. dark grey RAL 7001	Part no. black RAL 9005	Size Metr.	Spanner size mm	Unit	Net EUR/100 items at a purchase of		
						up to 100	101 - 500	501 - 1000
94630	94640	94650	M12 x 1,5	18	100	o. r.	o. r.	o. r.
94631	94641	94651	M16 x 1,5	22	100	o. r.	o. r.	o. r.
94632	94642	94652	M20 x 1,5	26	100	o. r.	o. r.	o. r.
94633	94643	94653	M25 x 1,5	32	100	o. r.	o. r.	o. r.
94634	94644	94654	M32 x 1,5	41	100	o. r.	o. r.	o. r.
94635	94645	94655	M40 x 1,5	50	50	o. r.	o. r.	o. r.
94636	94646	94656	M50 x 1,5	60	50	o. r.	o. r.	o. r.
94637	94647	94657	M63 x 1,5	75	25	o. r.	o. r.	o. r.

PG thread – female

Part no. light grey RAL 7035	Part no. dark grey RAL 7001	Part no. black RAL 9005	Size PG	Spanner size mm	Unit	Net EUR/100 items at a purchase of		
						up to 100	101 - 500	501 - 1000
94270	94280	94290	7	19	100	o. r.	o. r.	o. r.
94271	94281	94291	9	22	100	o. r.	o. r.	o. r.
94272	94282	94292	11	24	100	o. r.	o. r.	o. r.
94273	94283	94293	13,5	27	100	o. r.	o. r.	o. r.
94274	94284	94294	16	30	100	o. r.	o. r.	o. r.
94275	94285	94295	21	36	100	o. r.	o. r.	o. r.
94276	94286	94296	29	46	50	o. r.	o. r.	o. r.
94277	94287	94297	36	60	25	o. r.	o. r.	o. r.
94278	94288	94298	42	65	25	o. r.	o. r.	o. r.
94279	94289	94299	48	70	25	o. r.	o. r.	o. r.

Dimensions and specifications may be changed without prior notice.

o. r. = on request

VSK-PA Screw plug



VSK-PA

Screw plug made of polyamide.

Application

- Plant and machine construction
- Robotics
- Automation technology
- Vehicle construction and shipbuilding
- Railway technology
- Installation technology
- Control cabinet construction

Material

Polyamide

- halogen-free
- phosphor-free

Technical data

Protection class: IP 54

Temperature range: -40°C up to +100°C

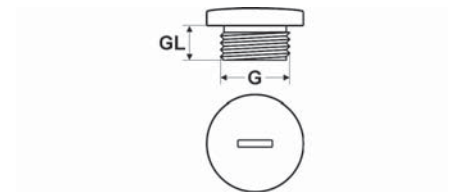

Dimensions

G Thread size
GL Thread length

Metric thread

Part no. light grey RAL 7035	Part no. dark grey RAL 7001	Part no. black RAL 9005	Size Metr.	Thread length mm	Unit	Net EUR/ 100 items at a purchase of		
						up to 100	101 - 500	501 - 1000
94700	94980	94750	M12 x 1,5	6,0	100	o. r.	o. r.	o. r.
94701	94981	94751	M16 x 1,5	7,0	100	o. r.	o. r.	o. r.
94702	94982	94752	M20 x 1,5	7,0	100	o. r.	o. r.	o. r.
94703	94983	94753	M25 x 1,5	10,0	100	o. r.	o. r.	o. r.
94704	94984	94754	M32 x 1,5	11,0	50	o. r.	o. r.	o. r.
94705	94985	94755	M40 x 1,5	13,0	50	o. r.	o. r.	o. r.
94706	94986	94756	M50 x 1,5	14,0	25	o. r.	o. r.	o. r.
94707	94987	94757	M63 x 1,5	15,0	25	o. r.	o. r.	o. r.

PG thread

Part no. light grey RAL 7035	Part no. dark grey RAL 7001	Part no. black RAL 9005	Size PG	Thread length mm	Unit	Net EUR/ 100 items at a purchase of		
						up to 100	101 - 500	501 - 1000
96593	94970	96997	7	6,0	100	o. r.	o. r.	o. r.
96179	94971	96998	9	6,5	100	o. r.	o. r.	o. r.
96180	94972	96999	11	6,5	100	o. r.	o. r.	o. r.
96181	94973	97000	13,5	6,5	100	o. r.	o. r.	o. r.
96182	94974	97001	16	6,5	100	o. r.	o. r.	o. r.
96183	94975	97002	21	8,0	50	o. r.	o. r.	o. r.
96184	94976	96527	29	8,0	25	o. r.	o. r.	o. r.
96185	94977	97004	36	10,0	25	o. r.	o. r.	o. r.
96960	94978	97005	42	10,0	25	o. r.	o. r.	o. r.
96961	94979	97006	48	12,0	25	o. r.	o. r.	o. r.

Dimensions and specifications may be changed without prior notice.

o. r. = on request

O-ring

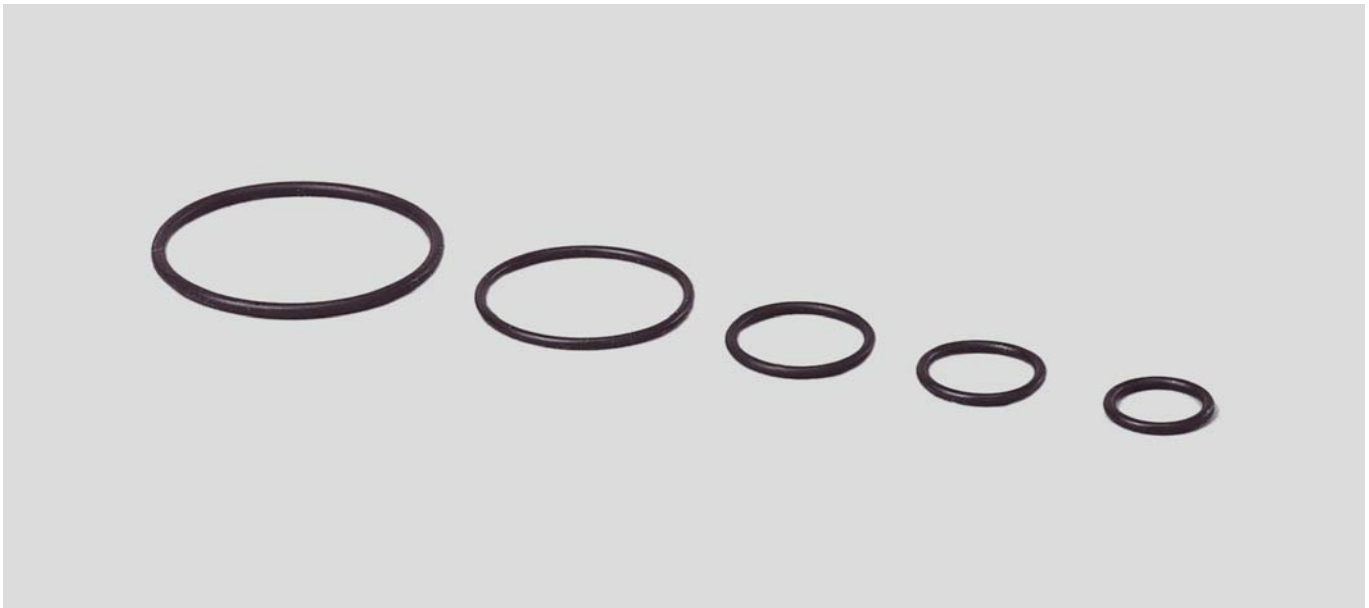

O-ring

O-rings for sealing against water, dust and oil.

Material

NBR

Technical data

Temperature range: -30°C up to +120°C

Application

- Plant and machine construction
- Robotics
- Automation technology
- Vehicle construction and shipbuilding
- Railway technology
- Installation technology
- Control cabinet construction

- halogen-free
- phosphor-free
- silicone-free

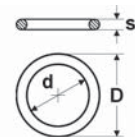

Dimensions

D Outer diameter
d Inner diameter
s Thickness

Metric thread

Part no.	Size	Inner Ø mm	Outer Ø mm	Thickness mm	Unit	Net EUR/100 items at a purchase of		
						up to 100	101 - 500	501 - 1000
90263	M12 x 1,5	9,0	12,0	1,5	100	o. r.	o. r.	o. r.
90264	M16 x 1,5	13,0	16,0	1,5	100	o. r.	o. r.	o. r.
90265	M20 x 1,5	17,0	20,0	1,5	100	o. r.	o. r.	o. r.
90266	M25 x 1,5	22,0	26,0	2,0	100	o. r.	o. r.	o. r.
90267	M32 x 1,5	29,0	33,0	2,0	100	o. r.	o. r.	o. r.
90268	M40 x 1,5	35,0	39,0	2,0	100	o. r.	o. r.	o. r.
90269	M50 x 1,5	45,0	49,0	2,0	100	o. r.	o. r.	o. r.
90270	M63 x 1,5	59,0	63,0	2,0	100	o. r.	o. r.	o. r.

PG thread

Part no.	Size	Inner Ø mm	Outer Ø mm	Thickness mm	Unit	Net EUR/100 items at a purchase of		
						up to 100	101 - 500	501 - 1000
96366	7	10,0	13,0	1,5	100	o. r.	o. r.	o. r.
96367	9	13,0	16,0	1,5	100	o. r.	o. r.	o. r.
96368	11	16,0	19,0	1,5	100	o. r.	o. r.	o. r.
96369	13,5	18,0	21,0	1,5	100	o. r.	o. r.	o. r.
96370	16	20,0	23,0	1,5	100	o. r.	o. r.	o. r.
96371	21	25,0	29,0	2,0	100	o. r.	o. r.	o. r.
96372	29	33,0	37,0	2,0	100	o. r.	o. r.	o. r.
96373	36	43,0	47,0	2,0	100	o. r.	o. r.	o. r.
96374	42	50,0	54,0	2,0	100	o. r.	o. r.	o. r.
96375	48	55,0	59,0	2,0	100	o. r.	o. r.	o. r.

Dimensions and specifications may be changed without prior notice.

o. r. = on request

AGDR-PE Sealing ring for connecting thread



AGDR-PE

Threaded connection rings for sealing against water and dust.

Application

- Plant and machine construction
- Robotics
- Automation technology
- Vehicle construction and shipbuilding
- Railway technology
- Installation technology
- Control cabinet construction

Material

Polyethylene

- halogen-free
- phosphor-free
- cadmium-free

Technical data

Temperature range: -30°C up to +70°C

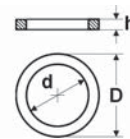

Dimensions

D Outer diameter
d Inner diameter
h Thickness

Metric thread

Part no.	Size	Inner Ø mm	Outer Ø mm	Thickness mm	Unit	Net EUR/ 100 items at a purchase of		
						up to 100	101 - 500	501 - 1000
90890	M12 x 1,5	12,0	16,0	2,0	500	o. r.	o. r.	o. r.
90891	M16 x 1,5	16,0	20,0	2,0	500	o. r.	o. r.	o. r.
90892	M20 x 1,5	20,0	25,0	2,0	500	o. r.	o. r.	o. r.
90893	M25 x 1,5	25,0	31,0	2,0	500	o. r.	o. r.	o. r.
90894	M32 x 1,5	32,0	38,0	2,0	250	o. r.	o. r.	o. r.
90896	M50 x 1,5	50,0	58,0	2,0	50	o. r.	o. r.	o. r.
90897	M63 x 1,5	63,0	72,0	2,0	50	o. r.	o. r.	o. r.

PG thread

Part no.	Size	Inner Ø mm	Outer Ø mm	Thickness mm	Unit	Net EUR/ 100 items at a purchase of		
						up to 100	101 - 500	501 - 1000
96529	7	12,5	16,5	1,5	500	o. r.	o. r.	o. r.
96530	9	15,2	19,0	1,5	500	o. r.	o. r.	o. r.
96531	11	18,6	22,5	1,5	500	o. r.	o. r.	o. r.
96532	13,5	20,4	25,0	1,5	500	o. r.	o. r.	o. r.
96533	16	22,5	27,0	1,5	500	o. r.	o. r.	o. r.
96534	21	28,3	33,5	2,0	500	o. r.	o. r.	o. r.
96535	29	37,0	43,5	2,0	250	o. r.	o. r.	o. r.
96537	42	54,0	63,0	2,0	50	o. r.	o. r.	o. r.
96538	48	59,3	69,0	2,0	50	o. r.	o. r.	o. r.

Dimensions and specifications may be changed without prior notice.

o. r. = on request

BL-H Blind plug

Hard

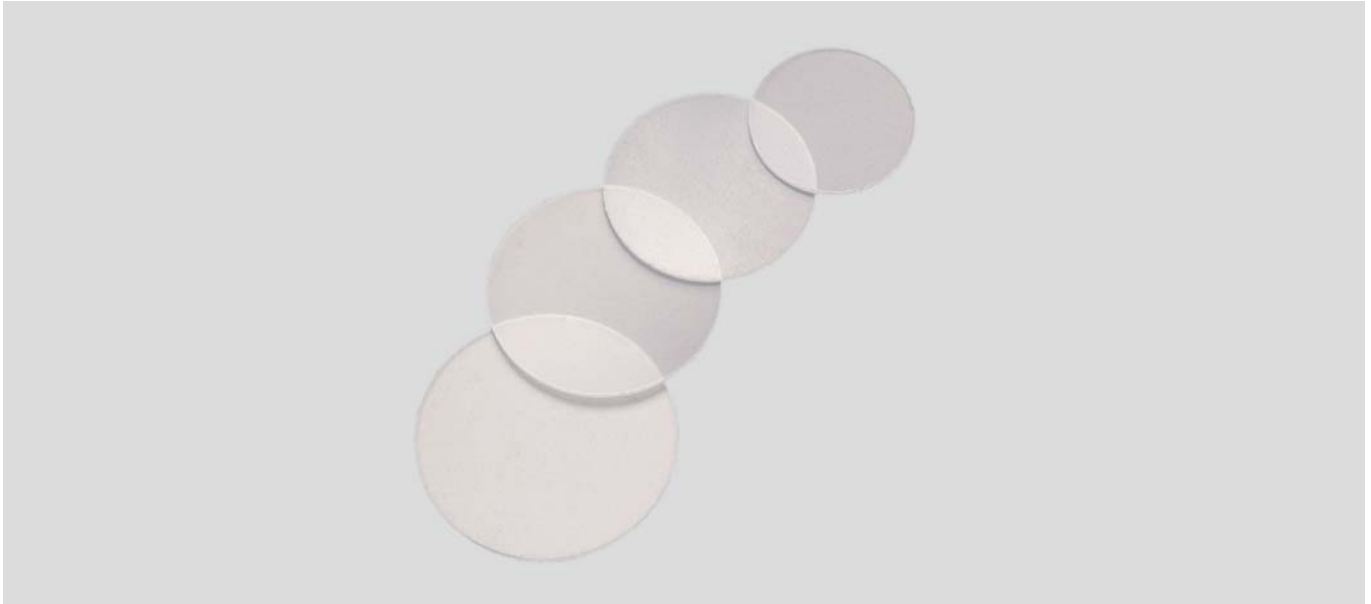

Blind plug BL-H

Blind plates as dust cap for HSK cable glands.

Material

Hard PVC

Technical data

Temperature range: -20°C up to +70°C

Application

- Plant and machine construction
- Robotics
- Automation technology
- Vehicle construction and shipbuilding
- Railway technology
- Installation technology
- Control cabinet construction



Dimensions

D Outer diameter

BL-H hard

Part no. clear	Size PG	Size metric	Size NPT	Outer Ø mm	Unit	Net EUR/ 100 items at a purchase of		
						up to 100	101 - 500	501 - 1000
96416	7	M12 x 1,5	-	11,0	500	o. r.	o. r.	o. r.
96417	9	M16 x 1,5	3/8"	13,5	500	o. r.	o. r.	o. r.
96418	11	-	-	17,0	500	o. r.	o. r.	o. r.
96419	13,5	M20 x 1,5	1/2"	18,5	500	o. r.	o. r.	o. r.
96420	16	-	-	20,5	500	o. r.	o. r.	o. r.
96421	21	M25 x 1,5	3/4"	26,0	500	o. r.	o. r.	o. r.
96422	29	M32 x 1,5	1"	35,0	250	o. r.	o. r.	o. r.
96423	36	M40 x 1,5	1 1/2"	45,0	100	o. r.	o. r.	o. r.
96424	42	M50 x 1,5	-	52,0	50	o. r.	o. r.	o. r.
96425	48	M63 x 1,5	-	57,0	50	o. r.	o. r.	o. r.

Dimensions and specifications may be changed without prior notice.

o. r. = on request

BL-W Blind plug

Soft



Blind plug BL-W

Blind plates as dust cap for HSK cable glands.

Material

Foam

Technical data

Temperature range: -20°C up to +70°C

Application

- Plant and machine construction
- Robotics
- Automation technology
- Vehicle construction and shipbuilding
- Railway technology
- Installation technology
- Control cabinet construction



Dimensions

D Outer diameter

BL-W flexible

Part no. black	Size PG	Size metric	Size NPT	Outer Ø mm	Unit	Net EUR/ 100 items at a purchase of		
						up to 100	101 - 500	501 - 1000
96376	7	-	-	11,0	500	o. r.	o. r.	o. r.
96377	9	M16 x 1,5	3/8"	13,5	500	o. r.	o. r.	o. r.
96378	11	-	-	17,0	500	o. r.	o. r.	o. r.
96915	13,5	M20 x 1,5	1/2"	18,8	500	o. r.	o. r.	o. r.
96379	16	-	-	20,9	500	o. r.	o. r.	o. r.
96380	21	M25 x 1,5	3/4"	26,5	500	o. r.	o. r.	o. r.
96381	29	M32 x 1,5	1"	35,0	250	o. r.	o. r.	o. r.
96382	36	M40 x 1,5	1 1/2"	45,0	100	o. r.	o. r.	o. r.
96383	42	M50 x 1,5	-	52,0	50	o. r.	o. r.	o. r.
96384	48	M63 x 1,5	-	57,4	50	o. r.	o. r.	o. r.

Dimensions and specifications may be changed without prior notice.

o. r. = on request

Incision sealing ring



Incision sealing ring

Incision sealing rings for universal cable inlet due to large cable clamping areas.

Application

- Plant and machine construction
- Robotics
- Automation technology
- Vehicle construction and shipbuilding
- Railway technology
- Installation technology
- Control cabinet construction

Material

Chloroprene-rubber (CR)

Colour: black

Note

Incision sealing rings for PG thread:

Material: NR

Temperature range: -40°C up to 90°C

Technical data

Temperature range: -30°C up to +120°C

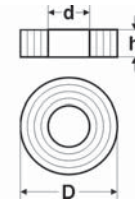

Dimensions

- D Outer diameter
- d Inner diameter
- h Thickness

Metric thread

Part no.	Size	Inner Ø mm	Outer Ø mm	incisions mm	Thickness mm	Unit	Net EUR/100 items at a purchase of		
							up to 100	101 - 500	501 - 1000
94860	M12 x 1,5	5,0	10,7	-	5,0	100	o. r.	o. r.	o. r.
94861	M16 x 1,5	3,0	13,8	39938	5,5	100	o. r.	o. r.	o. r.
94863	M20 x 1,5	4,0	17,7	7/10/13	6,0	100	o. r.	o. r.	o. r.
94865	M25 x 1,5	8,5	22,5	11/14/17	8,0	100	o. r.	o. r.	o. r.
94866	M32 x 1,5	16,0	29,5	19/21/24	9,5	100	o. r.	o. r.	o. r.
94867	M40 x 1,5	23,0	37,5	26/29/32	11,0	50	o. r.	o. r.	o. r.
94868	M50 x 1,5	32,0	47,5	35/38/41	12,0	50	o. r.	o. r.	o. r.
94869	M63 x 1,5	41,0	60,3	44/47/50	14,0	50	o. r.	o. r.	o. r.

PG thread

Part no.	Size	Inner Ø mm	Outer Ø mm	incisions mm	Thickness mm	Unit	Net EUR/100 items at a purchase of		
							up to 100	101 - 500	501 - 1000
96357	9	5,0	13,3	7,5/10	5,5	100	o. r.	o. r.	o. r.
96358	11	7,5	16,5	10/12,5	6,0	100	o. r.	o. r.	o. r.
96359	13,5	7,5	18,3	10/12,5	6,0	100	o. r.	o. r.	o. r.
96360	16	7,5	20,4	10/12,5/15	7,0	100	o. r.	o. r.	o. r.
96361	21	10,0	25,9	13/16/19	8,0	100	o. r.	o. r.	o. r.
96362	29	18,0	34,7	21/24/27	9,5	100	o. r.	o. r.	o. r.
96363	36	24,0	44,7	27/30/33	12,0	100	o. r.	o. r.	o. r.
96364	42	30,0	51,7	33/36/39	14,0	50	o. r.	o. r.	o. r.
96365	48	36,0	56,9	39/42/45	14,0	50	o. r.	o. r.	o. r.

Dimensions and specifications may be changed without prior notice.

o. r. = on request

HELUTOP HT HSK-PVDF

HELUTOP MS-EP4

KVA-XXL-MS

HELUTOP HT-Clean



■ BRASS CABLE GLANDS

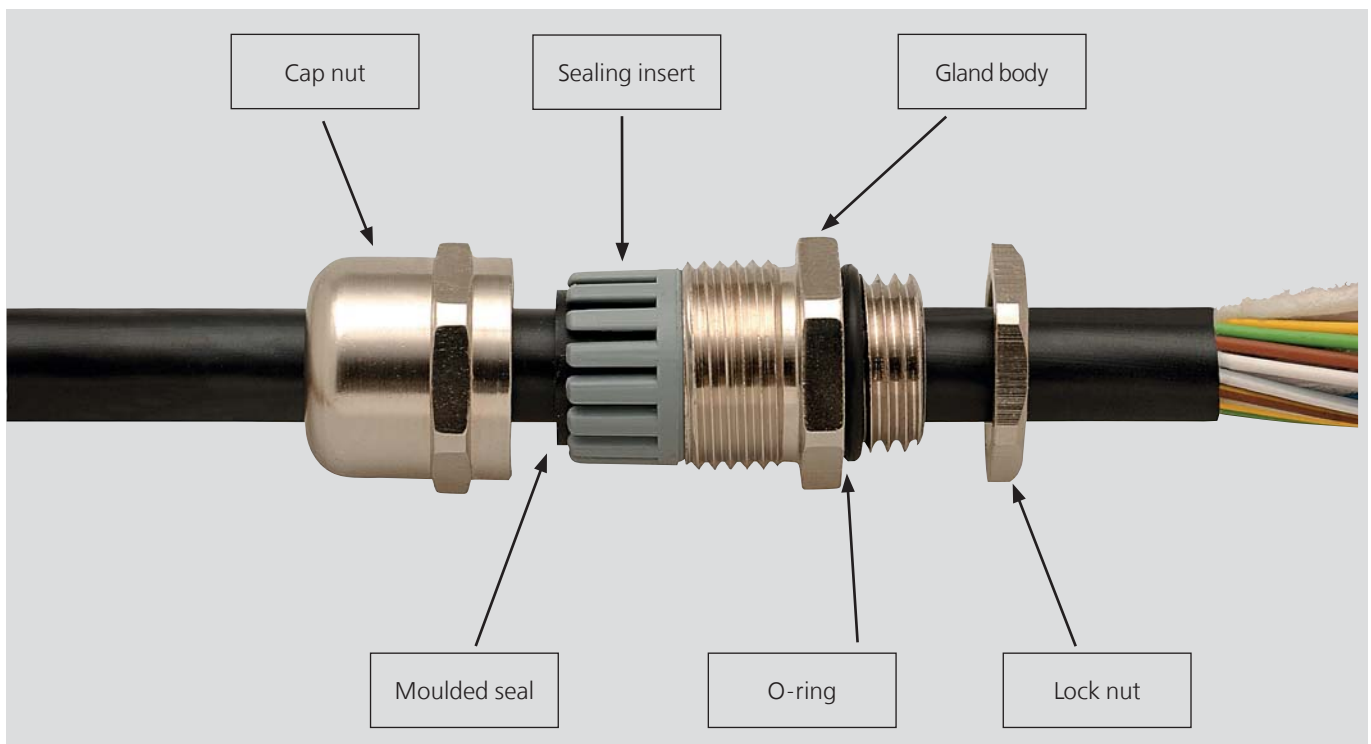

Cable gland

Cap nut and gland body are made from nickel-plated brass. These glands are used for standard applications where metal glands are needed.

The terminal insert is made from polyamide 6 (PA6).

The moulded seal is made from chloroprene rubber (CR, Neoprene).

The O-ring is made from nitrile rubber (NBR, Buna-N).

Lock nut

The lock nuts are made from nickel-plated brass.

Accessories

Accessories suitable for use with the brass cable glands:

- Lock nuts
- Adapters
- Extenders
- Reducers

Accessories suitable for use with all cable glands:

- Sealing plugs
- Multiple sealing inserts / lock bolts
- O-rings
- Connection thread gaskets
- Blind plates



HELUTOP® HT-MS

Nickel-coated brass cable gland.

Application

- Plant and machine construction
- Robotics
- Automation technology
- Vehicle construction and shipbuilding
- Railway technology
- Installation technology
- Control cabinet construction

Material

Brass, nickel plated
Clamp: Polyamide PA 6
Seal: Chloroprene-rubber (CR)
O-ring: NBR

Properties

- Optimum strain relief due to clamping plates
- Easy to assemble
- Large clamping areas

Note

Details on the individual tests appear in section "Technical Information".

Technical data

Protection class: IP 68 - 5 bar / IP 69K

Temperature range: -20°C up to +100°C
Temperature range temporary: -40°C up to +150°C

Test standard: EN50262

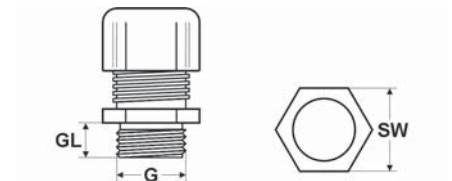

Dimensions

G Thread size
GL Thread length
SW Spanner size

Metric thread

Part no.	Size Metr.	Cable Ø from / to mm	Thread length mm	Spanner size mm	Unit	Net EUR/100 items at a purchase of		
						up to 100	101 - 500	501 - 1000
90760	M12 x 1,5	3,0 - 6,5	6,0	14	50	o. r.	o. r.	o. r.
99960	M16 x 1,5	5,0 - 10,0	7,0	20	50	o. r.	o. r.	o. r.
90762	M20 x 1,5	6,0 - 12,0	8,0	22	50	o. r.	o. r.	o. r.
99961	M25 x 1,5	11,0 - 17,0	8,0	27	25	o. r.	o. r.	o. r.
94624	M32 x 1,5	15,0 - 21,0	9,0	34	20	o. r.	o. r.	o. r.
99962	M40 x 1,5	19,0 - 28,0	9,0	43	5	o. r.	o. r.	o. r.
99963	M50 x 1,5	27,0 - 38,0	10,0	58	5	o. r.	o. r.	o. r.
90767	M63 x 1,5	34,0 - 44,0	10,0	64 / 68	5	o. r.	o. r.	o. r.
906199	M63 x 1,5	44,0 - 55,0	10,0	75	5	o. r.	o. r.	o. r.

Metric thread - with reducing seal

Part no.	Size Metr.	Cable Ø from / to mm	Thread length mm	Spanner size mm	Unit	Net EUR/100 items at a purchase of		
						up to 100	101 - 500	501 - 1000
903560	M12 x 1,5	2,0 - 5,0	6,0	14	50	o. r.	o. r.	o. r.
903561	M16 x 1,5	2,0 - 6,0	7,0	17 / 18	50	o. r.	o. r.	o. r.
903562	M20 x 1,5	5,0 - 9,0	8,0	22	50	o. r.	o. r.	o. r.
903563	M25 x 1,5	7,0 - 12,0	8,0	24 / 27	25	o. r.	o. r.	o. r.
903564	M32 x 1,5	9,0 - 16,0	9,0	30 / 34	20	o. r.	o. r.	o. r.
903565	M40 x 1,5	12,0 - 20,0	9,0	40 / 43	5	o. r.	o. r.	o. r.
903566	M50 x 1,5	20,0 - 26,0	10,0	50 / 55	5	o. r.	o. r.	o. r.
903567	M63 x 1,5	29,0 - 35,0	14,0	64 / 68	5	o. r.	o. r.	o. r.

Continuation ►

HELUTOP® HT-MS Cable gland



PG thread

Part no.	Size PG	Cable Ø from / to mm	Thread length mm	Spanner size mm	Unit	Net EUR/100 items at a purchase of		
						up to 100	101 - 500	501 - 1000
90750	7	3,0 - 6,5	6,0	14	50	o. r.	o. r.	o. r.
90751	9	4,0 - 8,0	6,0	17	50	o. r.	o. r.	o. r.
90752	11	5,0 - 10,0	6,0	20	50	o. r.	o. r.	o. r.
90753	13,5	6,0 - 12,0	6,5	22	50	o. r.	o. r.	o. r.
90754	16	10,0 - 14,0	6,5	24	25	o. r.	o. r.	o. r.
90755	21	13,0 - 18,0	7,2	30	25	o. r.	o. r.	o. r.
90756	29	18,0 - 25,0	8,0	40	20	o. r.	o. r.	o. r.
90757	36	30,0 - 32,0	9,0	50	5	o. r.	o. r.	o. r.
90758	42	30,0 - 38,0	12,0	58	5	o. r.	o. r.	o. r.
90759	48	34,0 - 44,0	14,0	64	5	o. r.	o. r.	o. r.

NPT thread

Part no.	Size NPT	Cable Ø from / to mm	Thread length mm	Spanner size mm	Unit	Net EUR/100 items at a purchase of		
						up to 100	101 - 500	501 - 1000
99965	3/8"	4,0 - 8,0	11,5	17 / 19	50	o. r.	o. r.	o. r.
99966	1/2"	6,0 - 12,0	13,0	22	50	o. r.	o. r.	o. r.
99967	3/4"	13,0 - 18,0	13,0	30	25	o. r.	o. r.	o. r.
99968	1"	18,0 - 25,0	13,0	40 / 43	10	o. r.	o. r.	o. r.

Dimensions and specifications may be changed without prior notice.

o. r. = on request

HELUTOP® sealing inserts, multiple sealing inserts, sealing billets



Sealing plug

For not assigned penetrations.

refer to page 33



UNI-DICHT sealing insert closed

Closed TPE-V sealing inserts which fit in UNI DICHT gland bodies - plastic or brass.

refer to page 48



HELUTOP® HT-MFDE

NBR multiple sealing inserts which fits in the HELUTOP® HT gland bodies made of polyamide and brass.

refer to page 32



HSK-MS

Cable gland for high performance applications.

Application

- Plant and machine construction
- Robotics
- Automation technology
- Vehicle construction and shipbuilding
- Railway technology
- Installation technology
- Control cabinet construction

Material

Brass, nickel plated
Clamp: Polyamide
Seal: NBR
O-ring: NBR

Properties

- Easy to assemble
- Completely watertight
- Optimum strain relief
- Large Clamping areas

Technical data

Protection class: IP 68 - 10 bar / IP 69K

Temperature range: -40°C up to +100°C

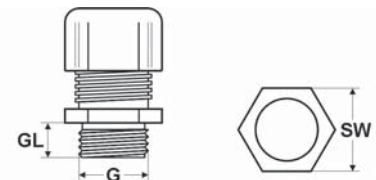

Dimensions

G Thread size
GL Thread length
SW Spanner size

Metric thread

Part no.	Size Metr.	Cable Ø from / to mm	Thread length mm	Spanner size mm	Unit	Net EUR/ 100 items at a purchase of		
						up to 100	101 - 500	501 - 1000
98285	M12 x 1,5	3,0 - 6,5	6,5	14	50	o. r.	o. r.	o. r.
90292	M16 x 1,5	4,0 - 8,0	6,0	17 / 19	50	o. r.	o. r.	o. r.
98033	M16 x 1,5	5,0 - 10,0	6,0	20	50	o. r.	o. r.	o. r.
90293	M20 x 1,5	6,0 - 12,0	6,0	22	50	o. r.	o. r.	o. r.
98034	M20 x 1,5	10,0 - 14,0	6,0	24	50	o. r.	o. r.	o. r.
90294	M25 x 1,5	13,0 - 18,0	7,0	30	25	o. r.	o. r.	o. r.
90295	M32 x 1,5	18,0 - 25,0	8,0	40	25	o. r.	o. r.	o. r.
90296	M40 x 1,5	22,0 - 32,0	8,0	50	10	o. r.	o. r.	o. r.
90297	M50 x 1,5	32,0 - 38,0	9,0	57	5	o. r.	o. r.	o. r.
90298	M63 x 1,5	37,0 - 44,0	10,0	64 / 68	5	o. r.	o. r.	o. r.

Metric thread - with reducing seal

Part no.	Size Metr.	Cable Ø from / to mm	Thread length mm	Spanner size mm	Unit	Net EUR/ 100 items at a purchase of		
						up to 100	101 - 500	501 - 1000
98035	M12 x 1,5	2,0 - 5,0	6,5	14	50	o. r.	o. r.	o. r.
98036	M16 x 1,5	2,0 - 6,0	6,0	17 / 19	50	o. r.	o. r.	o. r.
98038	M20 x 1,5	5,0 - 9,0	6,0	22	50	o. r.	o. r.	o. r.
98040	M25 x 1,5	9,0 - 16,0	7,0	30	25	o. r.	o. r.	o. r.
98041	M32 x 1,5	13,0 - 20,0	8,0	40	25	o. r.	o. r.	o. r.
98042	M40 x 1,5	20,0 - 26,0	8,0	50	10	o. r.	o. r.	o. r.
98043	M50 x 1,5	25,0 - 31,0	9,0	57	5	o. r.	o. r.	o. r.
98044	M63 x 1,5	29,0 - 35,0	10,0	64 / 68	5	o. r.	o. r.	o. r.

Continuation ►

PG thread

Part no.	Size PG	Cable Ø from / to mm	Thread length mm	Spanner size mm	Unit	Net EUR/ 100 items at a purchase of		
						up to 100	101 - 500	501 - 1000
90300	7	3,0 - 6,5	5,0	14	50	o. r.	o. r.	o. r.
90301	9	4,0 - 8,0	6,0	17	50	o. r.	o. r.	o. r.
90302	11	5,0 - 10,0	6,0	20	50	o. r.	o. r.	o. r.
90303	13,5	6,0 - 12,0	6,5	22	50	o. r.	o. r.	o. r.
90304	16	10,0 - 14,0	6,5	24	50	o. r.	o. r.	o. r.
90305	21	13,0 - 18,0	7,0	30	25	o. r.	o. r.	o. r.
90306	29	18,0 - 25,0	8,0	40	25	o. r.	o. r.	o. r.
90307	36	22,0 - 32,0	8,0	50	10	o. r.	o. r.	o. r.
90308	42	32,0 - 38,0	9,0	57	5	o. r.	o. r.	o. r.
90309	48	37,0 - 44,0	10,0	64	5	o. r.	o. r.	o. r.

PG thread - with reducing seal

Part no.	Size PG	Cable Ø from / to mm	Thread length mm	Spanner size mm	Unit	Net EUR/ 100 items at a purchase of		
						up to 100	101 - 500	501 - 1000
99208	7	2,0 - 5,0	5,0	14	50	o. r.	o. r.	o. r.
99209	9	2,0 - 6,0	6,0	17	50	o. r.	o. r.	o. r.
99210	11	3,0 - 7,0	6,0	20	50	o. r.	o. r.	o. r.
99211	13,5	5,0 - 9,0	6,5	22	50	o. r.	o. r.	o. r.
99212	16	7,0 - 12,0	6,5	24	50	o. r.	o. r.	o. r.
99213	21	9,0 - 16,0	7,0	30	25	o. r.	o. r.	o. r.
99214	29	13,0 - 20,0	8,0	40	25	o. r.	o. r.	o. r.
99215	36	20,0 - 26,0	8,0	50	10	o. r.	o. r.	o. r.
99216	42	25,0 - 31,0	9,0	57	5	o. r.	o. r.	o. r.
99217	48	29,0 - 35,0	10,0	64	5	o. r.	o. r.	o. r.

NPT thread

Part no.	Size NPT	Cable Ø from / to mm	Thread length mm	Spanner size mm	Unit	Net EUR/ 100 items at a purchase of		
						up to 100	101 - 500	501 - 1000
91845	3/8"	4,0 - 8,0	15,0	17 / 19	50	o. r.	o. r.	o. r.
91846	1/2"	6,0 - 12,0	13,0	22 / 24	50	o. r.	o. r.	o. r.
91847	3/4"	13,0 - 18,0	13,0	30	25	o. r.	o. r.	o. r.
91848	1"	18,0 - 25,0	19,0	40	25	o. r.	o. r.	o. r.

NPT thread - with reducing seal

Part no.	Size NPT	Cable Ø from / to mm	Thread length mm	Spanner size mm	Unit	Net EUR/ 100 items at a purchase of		
						up to 100	101 - 500	501 - 1000
96678	3/8"	2,0 - 6,0	15,0	17 / 19	50	o. r.	o. r.	o. r.
97103	1/2"	5,0 - 9,0	13,0	22 / 24	50	o. r.	o. r.	o. r.
97661	3/4"	9,0 - 16,0	13,0	30	25	o. r.	o. r.	o. r.
97662	1"	13,0 - 20,0	19,0	40	25	o. r.	o. r.	o. r.

Dimensions and specifications may be changed without prior notice.

o. r. = on request

HSK-MS-L Cable gland

Long thread



HSK-MS-L

With long threaded connection

Application

- Plant and machine construction
- Robotics
- Automation technology
- Vehicle construction and shipbuilding
- Railway technology
- Installation technology
- Control cabinet construction

Material

Brass, nickel plated
Clamp: Polyamide
Seal: NBR
O-ring: NBR

Properties

- Easy to assemble
- Completely watertight
- Optimum strain relief
- Large Clamping areas

Technical data

Protection class: IP 68 - 10 bar / IP 69K
Temperature range: -40°C up to +100°C

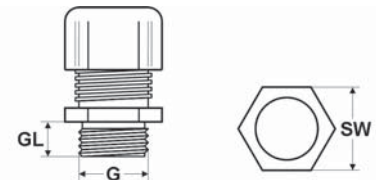

Dimensions

G Thread size
GL Thread length
SW Spanner size

Metric thread

Part no.	Size Metr.	Cable Ø from / to mm	Thread length mm	Spanner size mm	Unit	Net EUR/ 100 items at a purchase of		
						up to 100	101 - 500	501 - 1000
91720	M12 x 1,5	3,0 - 6,5	10,0	14	50	o. r.	o. r.	o. r.
91721	M16 x 1,5	4,0 - 8,0	10,0	17 / 19	50	o. r.	o. r.	o. r.
94559	M20 x 1,5	10,0 - 14,0	10,0	24	50	o. r.	o. r.	o. r.
903527	M25 x 1,5	13,0 - 18,0	12,0	30	25	o. r.	o. r.	o. r.
93539	M32 x 1,5	18,0 - 25,0	12,0	40	25	o. r.	o. r.	o. r.
91725	M40 x 1,5	20,0 - 26,0	15,0	50	10	o. r.	o. r.	o. r.
91726	M50 x 1,5	25,0 - 31,0	15,0	57	5	o. r.	o. r.	o. r.
91727	M63 x 1,5	29,0 - 35,0	15,0	64 / 68	5	o. r.	o. r.	o. r.

Metric thread - with reducing seal

Part no.	Size Metr.	Cable Ø from / to mm	Thread length mm	Spanner size mm	Unit	Net EUR/ 100 items at a purchase of		
						up to 100	101 - 500	501 - 1000
91722	M20 x 1,5	5,0 - 9,0	10,0	22	50	o. r.	o. r.	o. r.
91723	M25 x 1,5	9,0 - 16,0	12,0	30	25	o. r.	o. r.	o. r.
91724	M32 x 1,5	13,0 - 20,0	12,0	40	25	o. r.	o. r.	o. r.

PG thread - female

Part no.	Size PG	Cable Ø from / to mm	Thread length mm	Spanner size mm	Unit	Net EUR/ 100 items at a purchase of		
						up to 100	101 - 500	501 - 1000
90310	7	3,0 - 6,5	10,0	14	50	o. r.	o. r.	o. r.
90311	9	4,0 - 8,0	10,0	17	50	o. r.	o. r.	o. r.
90312	11	5,0 - 10,0	10,0	20	50	o. r.	o. r.	o. r.
90313	13,5	6,0 - 12,0	10,0	22	50	o. r.	o. r.	o. r.
90314	16	10,0 - 14,0	10,0	24	50	o. r.	o. r.	o. r.
90315	21	13,0 - 18,0	12,0	30	25	o. r.	o. r.	o. r.
90316	29	18,0 - 25,0	12,0	40	25	o. r.	o. r.	o. r.
90317	36	22,0 - 32,0	15,0	50	10	o. r.	o. r.	o. r.
90318	42	32,0 - 38,0	15,0	57	5	o. r.	o. r.	o. r.
90319	48	37,0 - 44,0	15,0	64	5	o. r.	o. r.	o. r.

Dimensions and specifications may be changed without prior notice.

o. r. = on request

HSK-MS-B Cable gland

Anti-kink



HSK-MS-B

With anti-kink spirals

Application

- Plant and machine construction
- Robotics
- Automation technology
- Vehicle construction and shipbuilding
- Railway technology
- Installation technology
- Control cabinet construction

Material

Brass, nickel plated
Clamp: Polyamide PA 6
Seal: NBR
O-ring: NBR
Kinking protection spring: Stainless steel
(1.4310)

Properties

- Easy to assemble
- Completely watertight
- Optimum strain relief
- Large Clamping areas

Technical data

Protection class: IP 68 - 10 bar / IP 69K

Temperature range: -40°C up to +100°C

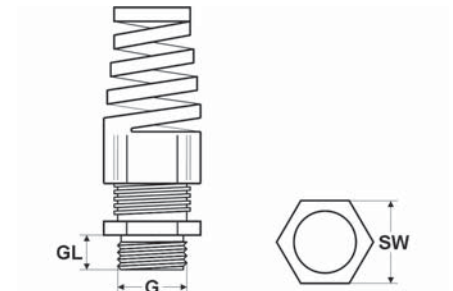

Dimensions

G Thread size
GL Thread length
SW Spanner size

Metric thread

Part no.	Size Metr.	Cable Ø from / to mm	Thread length mm	Spanner size mm	Unit	Net EUR/ 100 items at a purchase of		
						up to 100	101 - 500	501 - 1000
92917	M12 x 1,5	3,0 - 6,5	6,5	14	50	o. r.	o. r.	o. r.
92918	M16 x 1,5	4,0 - 8,0	6,0	19	50	o. r.	o. r.	o. r.
92919	M16 x 1,5	5,0 - 10,0	6,0	20	50	o. r.	o. r.	o. r.
92920	M20 x 1,5	6,0 - 12,0	6,0	22	50	o. r.	o. r.	o. r.
92921	M20 x 1,5	10,0 - 14,0	6,0	24	25	o. r.	o. r.	o. r.
92922	M25 x 1,5	13,0 - 18,0	7,0	30	20	o. r.	o. r.	o. r.

PG thread

Part no.	Size PG	Cable Ø from / to mm	Thread length mm	Spanner size mm	Unit	Net EUR/ 100 items at a purchase of		
						up to 100	101 - 500	501 - 1000
92911	7	3,0 - 6,5	5,0	14	50	o. r.	o. r.	o. r.
92912	9	4,0 - 8,0	6,0	17	50	o. r.	o. r.	o. r.
92913	11	5,0 - 10,0	6,0	20	50	o. r.	o. r.	o. r.
92914	13,5	6,0 - 12,0	6,5	22	50	o. r.	o. r.	o. r.
92915	16	10,0 - 14,0	6,5	24	25	o. r.	o. r.	o. r.
92916	21	13,0 - 18,0	7,0	30	20	o. r.	o. r.	o. r.

NPT thread

Part no.	Size NPT	Cable Ø from / to mm	Thread length mm	Spanner size mm	Unit	Net EUR/ 100 items at a purchase of		
						up to 100	101 - 500	501 - 1000
92923	3/8"	4,0 - 8,0	15,0	17 / 19	50	o. r.	o. r.	o. r.
92924	1/2"	6,0 - 12,0	13,0	22 / 24	50	o. r.	o. r.	o. r.
92925	3/4"	13,0 - 18,0	13,0	33	20	o. r.	o. r.	o. r.

Dimensions and specifications may be changed without prior notice.

o. r. = on request



UNI-DICHT-MS

Sealing cable gland. Nickel-coated brass with colour-coded TPE inserts.

Application

- Plant and machine construction
- Robotics
- Automation technology
- Vehicle construction and shipbuilding
- Railway technology
- Installation technology
- Control cabinet technology

Material

Brass, nickel plated
Seal: TPE

Properties

- Large-area cable sealing
- Easy to assemble
- Large clamping areas

Technical data

Protection class: IP 68 - 10 bar

Temperature range: -40°C up to +130°C

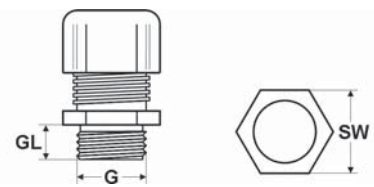

Dimensions

- G Thread size
- GL Thread length
- SW Spanner size

Metric thread

Part no.	Size Metr.	Sealing insert colour	Cable Ø from / to mm	Thread length mm	Spanner size mm	Unit	Net EUR/100 items at a purchase of		
							up to 100	101 - 500	501 - 1000
904061	M12 x 1,5	yellow/short	4,0 - 6,5	5,0	14	50	o. r.	o. r.	o. r.
904062	M16 x 1,5	yellow	4,0 - 6,5	6,0	18	50	o. r.	o. r.	o. r.
904063	M16 x 1,5	grey	5,0 - 8,0	6,0	18	50	o. r.	o. r.	o. r.
904064	M16 x 1,5	black	6,5 - 9,5	6,0	18	50	o. r.	o. r.	o. r.
904065	M20 x 1,5	yellow	4,0 - 6,5	6,5	22	50	o. r.	o. r.	o. r.
904066	M20 x 1,5	grey	5,0 - 8,0	6,5	22	50	o. r.	o. r.	o. r.
904067	M20 x 1,5	black	6,5 - 9,5	6,5	22	50	o. r.	o. r.	o. r.
904068	M20 x 1,5	green	7,0 - 10,5	6,5	22	50	o. r.	o. r.	o. r.
904069	M20 x 1,5	red	9,0 - 13,0	6,5	22	50	o. r.	o. r.	o. r.
904070	M25 x 1,5	yellow	4,0 - 6,5	7,5	28	50	o. r.	o. r.	o. r.
904071	M25 x 1,5	grey	5,0 - 8,0	7,5	28	50	o. r.	o. r.	o. r.
904072	M25 x 1,5	black	6,5 - 9,5	7,5	28	50	o. r.	o. r.	o. r.
904073	M25 x 1,5	green	7,0 - 10,5	7,5	28	50	o. r.	o. r.	o. r.
904074	M25 x 1,5	red	9,0 - 13,0	7,5	28	50	o. r.	o. r.	o. r.
904075	M25 x 1,5	white	11,5 - 15,5	7,5	28	50	o. r.	o. r.	o. r.
904076	M32 x 1,5	green	7,0 - 10,5	8,0	35	25	o. r.	o. r.	o. r.
904077	M32 x 1,5	red	9,0 - 13,0	8,0	35	25	o. r.	o. r.	o. r.
904078	M32 x 1,5	white	11,5 - 15,5	8,0	35	25	o. r.	o. r.	o. r.
904079	M32 x 1,5	blue	14,0 - 18,0	8,0	35	25	o. r.	o. r.	o. r.
904080	M32 x 1,5	brown	17,0 - 20,5	8,0	35	25	o. r.	o. r.	o. r.
904081	M40 x 1,5	blue	14,0 - 18,0	8,0	43	10	o. r.	o. r.	o. r.
904082	M40 x 1,5	brown	17,0 - 20,5	8,0	43	10	o. r.	o. r.	o. r.
904083	M40 x 1,5	orange	20,0 - 25,0	8,0	43	10	o. r.	o. r.	o. r.
904084	M40 x 1,5	light yellow	24,0 - 28,0	8,0	43	10	o. r.	o. r.	o. r.
904085	M50 x 1,5	anthracite	27,0 - 32,0	10,0	54	5	o. r.	o. r.	o. r.
904086	M50 x 1,5	light blue	29,0 - 34,0	10,0	54	5	o. r.	o. r.	o. r.
904087	M50 x 1,5	pink	32,0 - 36,0	10,0	54	5	o. r.	o. r.	o. r.

Continuation ►

UNI-DICHT-MS Cable gland



PG thread

Part no.	Size PG	Sealing insert colour	Cable Ø from / to mm	Thread length mm	Spanner size mm	Unit	Net EUR/100 items at a purchase of		
							up to 100	101 - 500	501 - 1000
904088	7	yellow	4,0 - 6,5	5,0	14	50	o. r.	o. r.	o. r.
904089	9	yellow	4,0 - 6,5	6,0	17	50	o. r.	o. r.	o. r.
904090	9	grey	5,0 - 8,0	6,0	17	50	o. r.	o. r.	o. r.
904091	9	black	6,5 - 9,5	6,0	17	50	o. r.	o. r.	o. r.
904092	11	yellow	4,0 - 6,5	6,0	20	50	o. r.	o. r.	o. r.
904093	11	grey	5,0 - 8,0	6,0	20	50	o. r.	o. r.	o. r.
904094	11	black	6,5 - 9,5	6,0	20	50	o. r.	o. r.	o. r.
904095	11	green	7,0 - 10,5	6,0	20	50	o. r.	o. r.	o. r.
904096	13,5	yellow	4,0 - 6,5	6,5	22	50	o. r.	o. r.	o. r.
904097	13,5	grey	5,0 - 8,0	6,5	22	50	o. r.	o. r.	o. r.
904098	13,5	black	6,5 - 9,5	6,5	22	50	o. r.	o. r.	o. r.
904099	13,5	green	7,0 - 10,5	6,5	22	50	o. r.	o. r.	o. r.
904100	13,5	red	9,0 - 13,0	6,5	22	50	o. r.	o. r.	o. r.
904101	16	yellow	4,0 - 6,5	6,5	24	50	o. r.	o. r.	o. r.
904102	16	grey	5,0 - 8,0	6,5	24	50	o. r.	o. r.	o. r.
904103	16	black	6,5 - 9,5	6,5	24	50	o. r.	o. r.	o. r.
904104	16	green	7,0 - 10,5	6,5	24	50	o. r.	o. r.	o. r.
904105	16	red	9,0 - 13,0	6,5	24	50	o. r.	o. r.	o. r.
904106	16	white	11,5 - 15,5	6,5	24	50	o. r.	o. r.	o. r.
904107	21	green	7,0 - 10,5	7,0	30	25	o. r.	o. r.	o. r.
904108	21	red	9,0 - 13,0	7,0	30	25	o. r.	o. r.	o. r.
904109	21	white	11,5 - 15,5	7,0	30	25	o. r.	o. r.	o. r.
904110	21	blue	14,0 - 18,0	7,0	30	25	o. r.	o. r.	o. r.
904111	21	brown	17,0 - 20,5	7,0	30	25	o. r.	o. r.	o. r.
904112	29	blue	14,0 - 18,0	8,0	40	10	o. r.	o. r.	o. r.
904113	29	brown	17,0 - 20,5	8,0	40	10	o. r.	o. r.	o. r.
904114	29	orange	20,0 - 25,0	8,0	40	10	o. r.	o. r.	o. r.
904115	29	light yellow	24,0 - 28,0	8,0	40	10	o. r.	o. r.	o. r.
904116	36	anthracite	27,0 - 32,0	9,0	50	10	o. r.	o. r.	o. r.
904117	36	light blue	29,0 - 34,0	9,0	50	10	o. r.	o. r.	o. r.
904118	36	pink	32,0 - 36,0	9,0	50	10	o. r.	o. r.	o. r.
904119	42	white	36,0 - 40,0	10,0	57	5	o. r.	o. r.	o. r.
904120	48	white	39,0 - 44,0	10,0	64	5	o. r.	o. r.	o. r.

Dimensions and specifications may be changed without prior notice.

o. r. = on request

UNI-DICHT-MFD-MS Cable gland



With multiple sealing inserts



UNI-DICHT-MFD-MS

Sealing cable gland made of brass with multiple sealing inserts made of TPE.

Material

Brass, nickel plated
Seal: TPE

Technical data

Protection class: IP 68

Temperature range: -40°C up to +130°C

Application

- Plant and machine construction
- Robotics
- Automation technology
- Vehicle construction and shipbuilding
- Railway technology
- Installation technology
- Control cabinet construction

Properties

- Large-area cable seal
- Easy to assemble

Note

Protection classification IP 68, provided that the bore diameter in the sealing insert area is equal to the cable diameter.

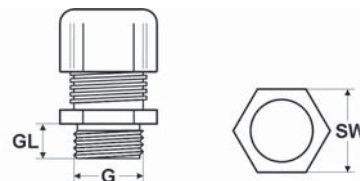

Dimensions

G Thread size
GL Thread length
SW Spanner size

Metric thread

Part no.	Size Metr.	Number holes x cable-Ø mm	Thread length mm	Spanner size mm	Unit	Net EUR/100 items at a purchase of		
						up to 100	101 - 500	501 - 1000
904125	M16 x 1,5	2 x 1,2	9,0	19	50	o. r.	o. r.	o. r.
904126	M16 x 1,5	2 x 3,0	9,0	19	50	o. r.	o. r.	o. r.
905024	M16 x 1,5	3 x 3,0	9,0	19	50	o. r.	o. r.	o. r.
904127	M16 x 1,5	4 x 3,0	9,0	19	50	o. r.	o. r.	o. r.
904128	M16 x 1,5	2 x 4,0	9,0	19	50	o. r.	o. r.	o. r.
904129	M16 x 1,5	1 x 5,0	9,0	19	50	o. r.	o. r.	o. r.
904130	M20 x 1,5	6 x 2,0	9,0	24	50	o. r.	o. r.	o. r.
904131	M20 x 1,5	2 x 2,3	9,0	24	50	o. r.	o. r.	o. r.
904132	M20 x 1,5	6 x 2,5	9,0	24	50	o. r.	o. r.	o. r.
904133	M20 x 1,5	2 x 3,0	9,0	24	50	o. r.	o. r.	o. r.
904134	M20 x 1,5	3 x 3,0	9,0	24	50	o. r.	o. r.	o. r.
904135	M20 x 1,5	2 x 5,0	9,0	24	50	o. r.	o. r.	o. r.
904136	M25 x 1,5	7 x 2,0	9,0	30	50	o. r.	o. r.	o. r.
904137	M25 x 1,5	2 x 4,0	9,0	30	50	o. r.	o. r.	o. r.
904138	M25 x 1,5	4 x 4,0	9,0	30	50	o. r.	o. r.	o. r.
904139	M25 x 1,5	6 x 4,0	9,0	30	50	o. r.	o. r.	o. r.
904140	M25 x 1,5	2 x 6,0	9,0	30	50	o. r.	o. r.	o. r.
904141	M25 x 1,5	3 x 7,0	9,0	30	50	o. r.	o. r.	o. r.
904142	M32 x 1,5	21 x 2,0	11,0	36	25	o. r.	o. r.	o. r.
904143	M32 x 1,5	8 x 3,0	11,0	36	25	o. r.	o. r.	o. r.
904144	M32 x 1,5	6 x 4,0	11,0	36	25	o. r.	o. r.	o. r.
904145	M32 x 1,5	8 x 4,0	11,0	36	25	o. r.	o. r.	o. r.
904146	M32 x 1,5	4 x 5,0	11,0	36	25	o. r.	o. r.	o. r.
904147	M32 x 1,5	4 x 6,0	11,0	36	25	o. r.	o. r.	o. r.
904148	M32 x 1,5	6 x 6,5	11,0	36	25	o. r.	o. r.	o. r.
904149	M32 x 1,5	3 x 7,0	11,0	36	25	o. r.	o. r.	o. r.
904150	M32 x 1,5	4 x 8,0	11,0	36	25	o. r.	o. r.	o. r.
904151	M32 x 1,5	2 x 9,0	11,0	36	25	o. r.	o. r.	o. r.

Continuation ►

With multiple sealing inserts

Metric thread

Part no.	Size Metr.	Number holes x cable-Ø mm	Thread length mm	Spanner size mm	Unit	Net EUR/ 100 items at a purchase of		
						up to 100	101 - 500	501 - 1000
904152	M40 x 1,5	6 x 6,0	11,5	46	10	o. r.	o. r.	o. r.
904153	M40 x 1,5	10 x 6,0	11,5	46	10	o. r.	o. r.	o. r.
904154	M40 x 1,5	4 x 6,5	11,5	46	10	o. r.	o. r.	o. r.
904155	M40 x 1,5	6 x 8,0	11,5	46	10	o. r.	o. r.	o. r.
904156	M40 x 1,5	4 x 9,0	11,5	46	10	o. r.	o. r.	o. r.
904157	M40 x 1,5	5 x 9,0	11,5	46	10	o. r.	o. r.	o. r.
904158	M40 x 1,5	5 x 10,0	11,5	46	10	o. r.	o. r.	o. r.
904159	M40 x 1,5	2 x 11,0	11,5	46	10	o. r.	o. r.	o. r.
904160	M50 x 1,5	15 x 5,0	14,0	55	5	o. r.	o. r.	o. r.
904161	M50 x 1,5	8 x 9,0	14,0	55	5	o. r.	o. r.	o. r.
904162	M50 x 1,5	3 x 10,0	14,0	55	5	o. r.	o. r.	o. r.
904163	M50 x 1,5	2 x 15,0	14,0	55	5	o. r.	o. r.	o. r.

PG thread

Part no.	Size PG	Number holes x cable-Ø mm	Thread length mm	Spanner size mm	Unit	Net EUR/ 100 items at a purchase of		
						up to 100	101 - 500	501 - 1000
904164	9	2 x 1,2	9,0	19	50	o. r.	o. r.	o. r.
904165	9	2 x 3,0	9,0	19	50	o. r.	o. r.	o. r.
904166	9	4 x 3,0	9,0	19	50	o. r.	o. r.	o. r.
904167	9	2 x 4,0	9,0	19	50	o. r.	o. r.	o. r.
904168	9	1 x 5,0	9,0	19	50	o. r.	o. r.	o. r.
904169	11	6 x 2,0	9,0	22	50	o. r.	o. r.	o. r.
904170	11	2 x 2,3	9,0	22	50	o. r.	o. r.	o. r.
904171	11	6 x 2,5	9,0	22	50	o. r.	o. r.	o. r.
904172	11	2 x 3,0	9,0	22	50	o. r.	o. r.	o. r.
904173	11	3 x 3,0	9,0	22	50	o. r.	o. r.	o. r.
904174	11	2 x 5,0	9,0	22	50	o. r.	o. r.	o. r.
904175	13,5	3 x 2,0	9,0	24	50	o. r.	o. r.	o. r.
904176	13,5	10 x 2,0	9,0	24	50	o. r.	o. r.	o. r.
904177	13,5	2 x 3,0	9,0	24	50	o. r.	o. r.	o. r.
904178	13,5	3 x 3,0	9,0	24	50	o. r.	o. r.	o. r.
904179	13,5	6 x 3,5	9,0	24	50	o. r.	o. r.	o. r.
904180	13,5	2 x 5,0	9,0	24	50	o. r.	o. r.	o. r.
904181	13,5	2 x 6,0	9,0	24	50	o. r.	o. r.	o. r.
904182	16	7 x 2,0	9,0	27	50	o. r.	o. r.	o. r.
904183	16	2 x 4,0	9,0	27	50	o. r.	o. r.	o. r.
904184	16	4 x 4,0	9,0	27	50	o. r.	o. r.	o. r.
904185	16	6 x 4,0	9,0	27	50	o. r.	o. r.	o. r.
904186	16	2 x 6,0	9,0	27	50	o. r.	o. r.	o. r.
904187	16	3 x 7,0	9,0	27	50	o. r.	o. r.	o. r.
904188	21	21 x 2,0	11,0	33	25	o. r.	o. r.	o. r.
904189	21	8 x 3,0	11,0	33	25	o. r.	o. r.	o. r.
904190	21	6 x 4,0	11,0	33	25	o. r.	o. r.	o. r.
904191	21	8 x 4,0	11,0	33	25	o. r.	o. r.	o. r.
904192	21	4 x 5,0	11,0	33	25	o. r.	o. r.	o. r.
904193	21	4 x 6,0	11,0	33	25	o. r.	o. r.	o. r.
904194	21	6 x 6,5	11,0	33	25	o. r.	o. r.	o. r.
904195	21	3 x 7,0	11,0	33	25	o. r.	o. r.	o. r.
904196	21	4 x 8,0	11,0	33	25	o. r.	o. r.	o. r.
904197	21	2 x 9,0	11,0	33	25	o. r.	o. r.	o. r.
904198	29	6 x 6,0	11,0	43	10	o. r.	o. r.	o. r.
904199	29	10 x 6,0	11,0	43	10	o. r.	o. r.	o. r.
904200	29	4 x 6,5	11,0	43	10	o. r.	o. r.	o. r.
904201	29	6 x 8,0	11,0	43	10	o. r.	o. r.	o. r.
904202	29	4 x 9,0	11,0	43	10	o. r.	o. r.	o. r.
904203	29	5 x 9,0	11,0	43	10	o. r.	o. r.	o. r.
904204	29	5 x 10,0	11,0	43	10	o. r.	o. r.	o. r.
904205	29	2 x 11,0	11,0	43	10	o. r.	o. r.	o. r.
904206	36	8 x 9,0	14,0	53	10	o. r.	o. r.	o. r.
904207	36	15 x 5,0	14,0	53	10	o. r.	o. r.	o. r.
904208	36	3 x 10,0	14,0	53	10	o. r.	o. r.	o. r.
904209	36	2 x 15,0	14,0	53	10	o. r.	o. r.	o. r.

Dimensions and specifications may be changed without prior notice.

o. r. = on request

UNI-DICHT-VK-MS Gland body



UNI-DICHT-VK-MS

Gland body made of brass for fitting in TPE inserts.

Application

- Plant and machine construction
- Robotics
- Automation technology
- Vehicle construction and shipbuilding
- Railway technology
- Installation technology
- Control cabinet construction

Material

Brass, nickel plated

Note

Gland body M20x1.5 (part no. 904212) is populated by inserts PG11; part no. 904213 is used with inserts PG13.5.

Part No. 904215 and 904225 cap aperture 18mm.

Part No. 904216 and 904226 cap aperture 21mm.

Technical data

Temperature range: up to +200°C

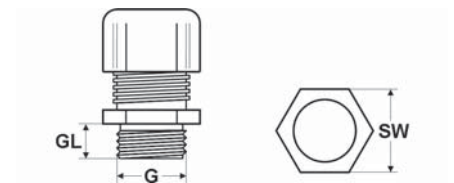

Dimensions

G Thread size
GL Thread length
SW Spanner size

Metric thread

Part no.	Size Metr.	Thread length mm	Spanner size mm	Unit	Net EUR/100 items at a purchase of		
					up to 100	101 - 500	501 - 1000
904210	M12 x 1,5	5,0	14	50	o. r.	o. r.	o. r.
904211	M16 x 1,5	6,0	18	50	o. r.	o. r.	o. r.
904212	M20 x 1,5	6,5	22	50	o. r.	o. r.	o. r.
904213	M20 x 1,5	6,5	22	50	o. r.	o. r.	o. r.
904214	M25 x 1,5	7,5	28	50	o. r.	o. r.	o. r.
904215	M32 x 1,5	8,0	35	25	o. r.	o. r.	o. r.
904216	M32 x 1,5	8,0	35	25	o. r.	o. r.	o. r.
904217	M40 x 1,5	8,0	43	10	o. r.	o. r.	o. r.
904218	M50 x 1,5	10,0	54	5	o. r.	o. r.	o. r.
904219	M63 x 1,5	10,0	68	5	o. r.	o. r.	o. r.

PG thread

Part no.	Size PG	Thread length mm	Spanner size mm	Unit	Net EUR/100 items at a purchase of		
					up to 100	101 - 500	501 - 1000
904220	7	5,0	14	50	o. r.	o. r.	o. r.
904221	9	6,0	17	50	o. r.	o. r.	o. r.
904222	11	6,0	20	50	o. r.	o. r.	o. r.
904223	13,5	6,5	22	50	o. r.	o. r.	o. r.
904224	16	6,5	24	50	o. r.	o. r.	o. r.
904225	21	7,0	30	25	o. r.	o. r.	o. r.
904226	21	7,0	30	25	o. r.	o. r.	o. r.
904227	29	8,0	40	10	o. r.	o. r.	o. r.
904228	36	9,0	50	10	o. r.	o. r.	o. r.
904229	42	10,0	57	5	o. r.	o. r.	o. r.
904230	48	10,0	64	5	o. r.	o. r.	o. r.

Dimensions and specifications may be changed without prior notice.

o. r. = on request

UNI-DICHT sealing inserts

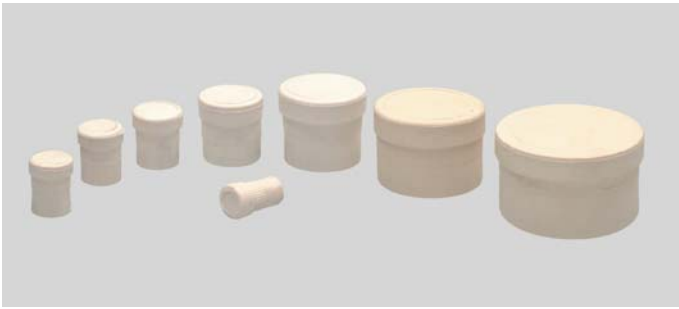

UNI-DICHT sealing insert closed

Closed TPE-V sealing inserts which fit in UNI DICHT gland bodies - plastic or brass.

refer to page 48



UNI-DICHT sealing insert standard

Colour coded TPE sealing insert for UNI DICHT gland bodies - polyamide or brass.

refer to page 49

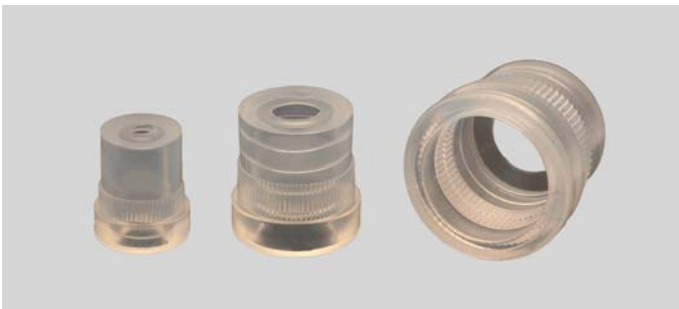

UNI-DICHT sealing insert silicone

Sealing inserts made of silicone for populating of UNI-DICHT gland bodies. For use in chemical industry and at high temperatures.

refer to page 148



UNI-DICHT multiple sealing insert

Multiple TPE sealing insert for fitting in UNI DICHT gland bodies - polyamide or brass.

refer to page 52



Sealing plug

For not assigned penetrations.

refer to page 33

UNI-DICHT-ASI-MS Cable gland



Profile fits to ASI-bus line



UNI-DICHT-ASI-MS

Sealing cable gland made of brass with inserts made of TPE-V, profile fits to ASI- bus line.

Application

- Plant and machine construction
- Robotics
- Automation technology
- Installation technology
- Control cabinet construction

Material

Brass, nickel plated
Seal: TPE-V

Properties

- Large-area cable sealing
- Easy to assemble

Technical data

Protection class: IP 68 - 10 bar

Temperature range: -40°C up to +135°C

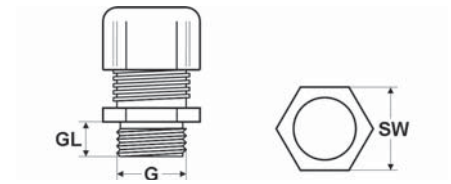

Dimensions

G Thread size
GL Thread length
SW Spanner size

Metric thread

Part no.	Size Metr.	Sealing insert colour	Cable Ø from / to mm	Thread length mm	Spanner size mm	Unit	Net EUR/100 items at a purchase of		
							up to 100	101 - 500	501 - 1000
904121	M20 x 1,5	grey, left	-	6,5	22	50	o. r.	o. r.	o. r.
904122	M20 x 1,5	grey, right	-	6,5	22	50	o. r.	o. r.	o. r.

PG thread

Part no.	Size PG	Sealing insert colour	Cable Ø from / to mm	Thread length mm	Spanner size mm	Unit	Net EUR/100 items at a purchase of		
							up to 100	101 - 500	501 - 1000
904123	13,5	grey, left	-	6,5	22	50	o. r.	o. r.	o. r.
904124	13,5	grey, right	-	6,5	22	50	o. r.	o. r.	o. r.

Dimensions and specifications may be changed without prior notice.

o. r. = on request

KVA-MS Cable gland



KVA-MS

Sealing cable gland made of brass with colour-coded Soft PVC inserts.

Application

- Plant and machine construction
- Robotics
- Automation technology
- Vehicle construction and shipbuilding
- Railway technology
- Installation technology
- Control cabinet construction

Material

Brass, nickel plated
Seal: Soft PVC
O-ring: NBR

Properties

- Large-area cable sealing
- Easy to assemble
- Large clamping areas

Technical data

Protection class: IP 68 - 10 bar

Temperature range: -20°C up to +105°C

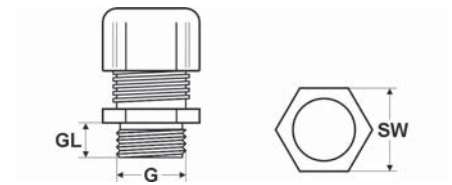

Dimensions

G Thread size
GL Thread length
SW Spanner size

Metric thread

Part no.	Size Metr.	Sealing insert colour	Cable Ø from / to mm	Thread length mm	Spanner size mm	Unit	Net EUR/100 items at a purchase of		
							up to 100	101 - 500	501 - 1000
90800	M12 x 1,5	yellow	4,0 - 6,5	6,0	14	100	o. r.	o. r.	o. r.
90801	M16 x 1,5	yellow	4,0 - 6,5	6,5	17	100	o. r.	o. r.	o. r.
90802	M16 x 1,5	grey	5,0 - 8,0	6,5	17	100	o. r.	o. r.	o. r.
90803	M16 x 1,5	black	6,5 - 9,5	6,5	17	100	o. r.	o. r.	o. r.
90804	M20 x 1,5	yellow	4,0 - 6,5	7,0	22	50	o. r.	o. r.	o. r.
90805	M20 x 1,5	grey	5,0 - 8,0	7,0	22	50	o. r.	o. r.	o. r.
90807	M20 x 1,5	black	6,5 - 9,5	7,0	22	50	o. r.	o. r.	o. r.
90808	M20 x 1,5	green	7,0 - 10,5	7,0	22	50	o. r.	o. r.	o. r.
90809	M20 x 1,5	red	9,0 - 13,0	7,0	22	50	o. r.	o. r.	o. r.
90811	M25 x 1,5	yellow	4,0 - 6,5	7,5	27	50	o. r.	o. r.	o. r.
90812	M25 x 1,5	grey	5,0 - 8,0	7,5	27	50	o. r.	o. r.	o. r.
90813	M25 x 1,5	black	6,5 - 9,5	7,5	27	50	o. r.	o. r.	o. r.
90814	M25 x 1,5	green	7,0 - 10,5	7,5	27	50	o. r.	o. r.	o. r.
90815	M25 x 1,5	red	9,0 - 13,0	7,5	27	50	o. r.	o. r.	o. r.
90816	M25 x 1,5	white	11,5 - 15,5	7,5	27	50	o. r.	o. r.	o. r.
90817	M32 x 1,5	green	7,0 - 10,5	8,0	35	25	o. r.	o. r.	o. r.
90818	M32 x 1,5	red	9,0 - 13,0	8,0	35	25	o. r.	o. r.	o. r.
90819	M32 x 1,5	white	11,5 - 15,5	8,0	35	25	o. r.	o. r.	o. r.
90820	M32 x 1,5	blue	14,0 - 18,0	8,0	35	25	o. r.	o. r.	o. r.
90821	M32 x 1,5	brown	17,0 - 21,0	8,0	35	25	o. r.	o. r.	o. r.
90822	M40 x 1,5	blue	14,0 - 18,0	8,0	43	10	o. r.	o. r.	o. r.
90823	M40 x 1,5	brown	17,0 - 21,0	8,0	43	10	o. r.	o. r.	o. r.
90824	M40 x 1,5	orange	20,0 - 25,0	8,0	43	10	o. r.	o. r.	o. r.
90825	M40 x 1,5	light yellow	24,0 - 28,0	8,0	43	10	o. r.	o. r.	o. r.
90826	M50 x 1,5	anthracite	27,0 - 32,0	10,0	54	10	o. r.	o. r.	o. r.
90827	M50 x 1,5	light blue	29,0 - 34,0	10,0	54	10	o. r.	o. r.	o. r.
90828	M50 x 1,5	pink	32,0 - 37,0	10,0	54	10	o. r.	o. r.	o. r.

Continuation ►

KVA-MS Cable gland

PG thread

Part no.	Size PG	Sealing insert colour	Cable Ø from / to mm	Thread length mm	Spanner size mm	Unit	Net EUR/100 items at a purchase of		
							up to 100	101 - 500	501 - 1000
90354	7	yellow	4,0 - 6,5	5,0	14	100	o. r.	o. r.	o. r.
90355	9	yellow	4,0 - 6,5	6,0	17	100	o. r.	o. r.	o. r.
90356	9	grey	5,0 - 8,0	6,0	17	100	o. r.	o. r.	o. r.
90357	9	black	6,5 - 9,5	6,0	17	100	o. r.	o. r.	o. r.
96149	11	yellow	4,0 - 6,5	6,0	20	50	o. r.	o. r.	o. r.
90358	11	grey	5,0 - 8,0	6,0	20	50	o. r.	o. r.	o. r.
90359	11	black	6,5 - 9,5	6,0	20	50	o. r.	o. r.	o. r.
90360	11	green	7,0 - 10,5	6,0	20	50	o. r.	o. r.	o. r.
97119	13,5	yellow	4,0 - 6,5	6,5	22	50	o. r.	o. r.	o. r.
97120	13,5	grey	5,0 - 8,0	6,5	22	50	o. r.	o. r.	o. r.
90361	13,5	black	6,5 - 9,5	6,5	22	50	o. r.	o. r.	o. r.
90362	13,5	green	7,0 - 10,5	6,5	22	50	o. r.	o. r.	o. r.
90363	13,5	red	9,0 - 13,0	6,5	22	50	o. r.	o. r.	o. r.
90364	13,5	white	11,0 - 15,5	6,5	24	50	o. r.	o. r.	o. r.
91974	16	yellow	4,0 - 6,5	6,5	24	50	o. r.	o. r.	o. r.
92093	16	grey	5,0 - 8,0	6,5	24	50	o. r.	o. r.	o. r.
90365	16	black	6,5 - 9,5	6,5	24	50	o. r.	o. r.	o. r.
90366	16	green	7,0 - 10,5	6,5	24	50	o. r.	o. r.	o. r.
90367	16	red	9,0 - 13,0	6,5	24	50	o. r.	o. r.	o. r.
90368	16	white	11,5 - 15,0	6,5	24	50	o. r.	o. r.	o. r.
90369	21	green	7,0 - 10,5	7,0	30	25	o. r.	o. r.	o. r.
90370	21	red	9,0 - 13,0	7,0	30	25	o. r.	o. r.	o. r.
90371	21	white	11,5 - 15,5	7,0	30	25	o. r.	o. r.	o. r.
90372	21	blue	14,0 - 18,0	7,0	30	25	o. r.	o. r.	o. r.
90373	21	brown	17,0 - 21,0	7,0	30	25	o. r.	o. r.	o. r.
90374	29	blue	14,0 - 18,0	8,0	40	10	o. r.	o. r.	o. r.
90375	29	brown	17,0 - 21,0	8,0	40	10	o. r.	o. r.	o. r.
90376	29	orange	20,0 - 25,0	8,0	40	10	o. r.	o. r.	o. r.
96526	29	light yellow	24,0 - 28,0	8,0	40	10	o. r.	o. r.	o. r.
90390	36	anthracite	27,0 - 32,0	9,0	50	10	o. r.	o. r.	o. r.
90391	36	light blue	29,0 - 34,0	9,0	50	10	o. r.	o. r.	o. r.
90392	36	pink	32,0 - 37,0	9,0	50	10	o. r.	o. r.	o. r.
90393	42	white	36,0 - 41,0	10,0	60	10	o. r.	o. r.	o. r.
90394	48	white	39,0 - 45,0	10,0	65	5	o. r.	o. r.	o. r.

Dimensions and specifications may be changed without prior notice.

o. r. = on request

KVA-MFD-MS Cable gland

With multiple sealing inserts



KVA-MFD-MS

Cable gland made of brass with multiple sealing inserts made of Soft PVC inserts.

Application

- Plant and machine construction
- Robotics
- Automation technology
- Vehicle construction and shipbuilding
- Railway technology
- Installation technology
- Control cabinet construction

Material

Brass, nickel plated
Seal: Soft PVC
O-ring: NBR

Properties

- Large-area cable sealing
- Easy to assemble

Note

Protection class IP 68, if the bore diameter in the sealing insert area is equal to the cable diameter.

Technical data

Protection class: IP 68 - 10 bar

Temperature range: -20°C up to +105°C

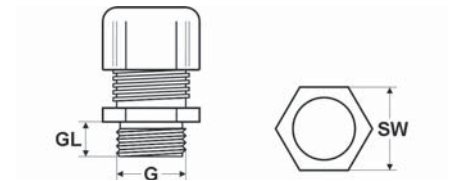

Dimensions

G Thread size
GL Thread length
SW Spanner size

Metric thread

Part no.	Size Metr.	Number holes x cable-Ø mm	Thread length mm	Spanner size mm	Unit	Net EUR/ 100 items at a purchase of		
						up to 100	101 - 500	501 - 1000
93400	M16 x 1,5	2 x 1,0	6,5	17	100	o. r.	o. r.	o. r.
93401	M16 x 1,5	2 x 3,0	6,5	17	100	o. r.	o. r.	o. r.
93402	M16 x 1,5	4 x 3,0	6,5	17	100	o. r.	o. r.	o. r.
93403	M16 x 1,5	2 x 4,0	6,5	17	100	o. r.	o. r.	o. r.
93404	M16 x 1,5	1 x 5,0	6,5	17	100	o. r.	o. r.	o. r.
93405	M20 x 1,5	6 x 2,0	7,0	22	50	o. r.	o. r.	o. r.
93406	M20 x 1,5	2 x 2,3	7,0	22	50	o. r.	o. r.	o. r.
93407	M20 x 1,5	6 x 2,5	7,0	22	50	o. r.	o. r.	o. r.
93408	M20 x 1,5	2 x 3,0	7,0	22	50	o. r.	o. r.	o. r.
93409	M20 x 1,5	3 x 3,0	7,0	22	50	o. r.	o. r.	o. r.
93410	M20 x 1,5	2 x 5,0	7,0	22	50	o. r.	o. r.	o. r.
93411	M25 x 1,5	7 x 2,0	7,5	27	50	o. r.	o. r.	o. r.
93412	M25 x 1,5	2 x 4,0	7,5	27	50	o. r.	o. r.	o. r.
93413	M25 x 1,5	4 x 4,0	7,5	27	50	o. r.	o. r.	o. r.
93414	M25 x 1,5	6 x 4,0	7,5	27	50	o. r.	o. r.	o. r.
93415	M25 x 1,5	2 x 6,0	7,5	27	50	o. r.	o. r.	o. r.
93416	M25 x 1,5	3 x 7,0	7,5	27	50	o. r.	o. r.	o. r.
93417	M32 x 1,5	21 x 2,0	8,0	35	25	o. r.	o. r.	o. r.
93418	M32 x 1,5	8 x 3,0	8,0	35	25	o. r.	o. r.	o. r.
93419	M32 x 1,5	6 x 4,0	8,0	35	25	o. r.	o. r.	o. r.
93420	M32 x 1,5	8 x 4,0	8,0	35	25	o. r.	o. r.	o. r.
93421	M32 x 1,5	4 x 5,0	8,0	35	25	o. r.	o. r.	o. r.
93422	M32 x 1,5	4 x 6,0	8,0	35	25	o. r.	o. r.	o. r.
93423	M32 x 1,5	6 x 6,5	8,0	35	25	o. r.	o. r.	o. r.
93424	M32 x 1,5	3 x 7,0	8,0	35	25	o. r.	o. r.	o. r.
93425	M32 x 1,5	4 x 8,0	8,0	35	25	o. r.	o. r.	o. r.
93426	M32 x 1,5	2 x 9,0	8,0	35	25	o. r.	o. r.	o. r.

Continuation ►

KVA-MFD-MS Cable gland

With multiple sealing inserts

Metric thread

Part no.	Size Metr.	Number holes x cable-Ø mm	Thread length mm	Spanner size mm	Unit	Net EUR/ 100 items at a purchase of		
						up to 100	101 - 500	501 - 1000
93429	M40 x 1,5	6 x 6,0	8,0	43	10	o. r.	o. r.	o. r.
93427	M40 x 1,5	10 x 6,0	8,0	43	10	o. r.	o. r.	o. r.
93428	M40 x 1,5	4 x 6,5	8,0	43	10	o. r.	o. r.	o. r.
93430	M40 x 1,5	6 x 8,0	8,0	43	10	o. r.	o. r.	o. r.
93431	M40 x 1,5	4 x 9,0	8,0	43	10	o. r.	o. r.	o. r.
93432	M40 x 1,5	5 x 9,0	8,0	43	10	o. r.	o. r.	o. r.
93433	M40 x 1,5	5 x 10,0	8,0	43	10	o. r.	o. r.	o. r.
93434	M40 x 1,5	2 x 11,0	8,0	43	10	o. r.	o. r.	o. r.
93436	M50 x 1,5	15 x 5,0	10,0	54	10	o. r.	o. r.	o. r.
93435	M50 x 1,5	8 x 9,0	10,0	54	10	o. r.	o. r.	o. r.
93437	M50 x 1,5	3 x 10,0	10,0	54	10	o. r.	o. r.	o. r.
93438	M50 x 1,5	2 x 15,0	10,0	54	10	o. r.	o. r.	o. r.

PG thread

Part no.	Size PG	Number holes x cable-Ø mm	Thread length mm	Spanner size mm	Unit	Net EUR/ 100 items at a purchase of		
						up to 100	101 - 500	501 - 1000
92094	9	2 x 1,0	6,0	17 / 20	100	o. r.	o. r.	o. r.
92039	9	2 x 3,0	6,0	17 / 20	100	o. r.	o. r.	o. r.
92041	9	4 x 3,0	6,0	17 / 20	100	o. r.	o. r.	o. r.
92042	9	2 x 4,0	6,0	17 / 20	100	o. r.	o. r.	o. r.
92043	9	1 x 5,0	6,0	17 / 20	100	o. r.	o. r.	o. r.
92044	11	6 x 2,0	6,0	20 / 22	50	o. r.	o. r.	o. r.
92045	11	2 x 2,3	6,0	20 / 22	50	o. r.	o. r.	o. r.
92046	11	6 x 2,5	6,0	20 / 22	50	o. r.	o. r.	o. r.
92047	11	2 x 3,0	6,0	20 / 22	50	o. r.	o. r.	o. r.
92048	11	3 x 3,0	6,0	20 / 22	50	o. r.	o. r.	o. r.
96881	11	2 x 5,0	6,0	20 / 22	50	o. r.	o. r.	o. r.
92052	13,5	3 x 2,0	6,5	24 / 30	50	o. r.	o. r.	o. r.
92053	13,5	10 x 2,0	6,5	24 / 30	50	o. r.	o. r.	o. r.
92054	13,5	2 x 3,0	6,5	24 / 30	50	o. r.	o. r.	o. r.
92055	13,5	3 x 3,0	6,5	24 / 30	50	o. r.	o. r.	o. r.
92095	13,5	6 x 3,5	6,5	24 / 30	50	o. r.	o. r.	o. r.
92096	13,5	2 x 5,0	6,5	24 / 30	50	o. r.	o. r.	o. r.
92057	13,5	2 x 6,0	6,5	24 / 30	50	o. r.	o. r.	o. r.
92058	16	7 x 2,0	6,5	24 / 30	50	o. r.	o. r.	o. r.
92097	16	2 x 4,0	6,5	24 / 30	50	o. r.	o. r.	o. r.
92060	16	4 x 4,0	6,5	24 / 30	50	o. r.	o. r.	o. r.
92061	16	6 x 4,0	6,5	24 / 30	50	o. r.	o. r.	o. r.
92062	16	2 x 6,0	6,5	24 / 30	50	o. r.	o. r.	o. r.
96434	16	3 x 7,0	6,5	24 / 30	50	o. r.	o. r.	o. r.
92064	21	21 x 2,0	7,0	30 / 40	25	o. r.	o. r.	o. r.
92065	21	8 x 3,0	7,0	30 / 40	25	o. r.	o. r.	o. r.
92066	21	6 x 4,0	7,0	30 / 40	25	o. r.	o. r.	o. r.
92067	21	8 x 4,0	7,0	30 / 40	25	o. r.	o. r.	o. r.
96956	21	4 x 5,0	7,0	30 / 40	50	o. r.	o. r.	o. r.
92069	21	4 x 6,0	7,0	30 / 40	25	o. r.	o. r.	o. r.
92068	21	6 x 6,5	7,0	30 / 40	25	o. r.	o. r.	o. r.
92070	21	3 x 7,0	7,0	30 / 40	25	o. r.	o. r.	o. r.
92072	21	4 x 8,0	7,0	30 / 40	25	o. r.	o. r.	o. r.
92098	21	2 x 9,0	7,0	30 / 40	25	o. r.	o. r.	o. r.
96430	29	6 x 6,0	8,0	40	25	o. r.	o. r.	o. r.
97327	29	10 x 6,0	8,0	40	25	o. r.	o. r.	o. r.
92099	29	4 x 6,5	8,0	40	10	o. r.	o. r.	o. r.
96710	29	6 x 8,0	8,0	40	10	o. r.	o. r.	o. r.
92074	29	4 x 9,0	8,0	40	10	o. r.	o. r.	o. r.
96564	29	5 x 9,0	8,0	40	10	o. r.	o. r.	o. r.
92075	29	5 x 10,0	8,0	40	10	o. r.	o. r.	o. r.
92076	29	2 x 11,0	8,0	40	10	o. r.	o. r.	o. r.
92077	36	15 x 5,0	8,5	50	10	o. r.	o. r.	o. r.
96336	36	8 x 9,0	8,5	50	25	o. r.	o. r.	o. r.
92079	36	3 x 10,0	8,5	50	10	o. r.	o. r.	o. r.
96397	36	2 x 15,0	8,5	50	25	o. r.	o. r.	o. r.

Dimensions and specifications may be changed without prior notice.

o. r. = on request

KVA-VK-MS Body gland



KVA-VK-MS

Gland body made of brass suitable for Soft-PVC inserts.

Material

Brass, nickel plated
O-ring: NBR

Technical data

Temperature range: -30°C up to +100°C

Application

- Plant and machine construction
- Robotics
- Automation technology
- Vehicle construction and shipbuilding
- Railway technology
- Installation technology
- Control cabinet construction

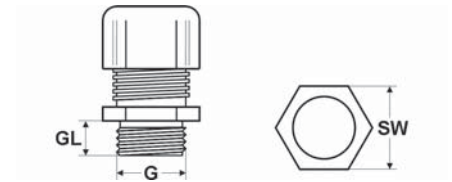

Dimensions

G Thread size
GL Thread length
SW Spanner size

Metric thread

Part no.	Size Metr.	Thread length mm	Spanner size mm	Unit	Net EUR/100 items at a purchase of		
					up to 100	101 - 500	501 - 1000
90788	M12 x 1,5	6,0	14	100	o. r.	o. r.	o. r.
90789	M16 x 1,5	6,5	17	100	o. r.	o. r.	o. r.
90790	M20 x 1,5	7,0	22	50	o. r.	o. r.	o. r.
90792	M25 x 1,5	7,5	27	50	o. r.	o. r.	o. r.
91367	M32 x 1,5	8,0	35	25	o. r.	o. r.	o. r.
90794	M40 x 1,5	8,0	43	10	o. r.	o. r.	o. r.
90795	M50 x 1,5	10,0	54	10	o. r.	o. r.	o. r.
90796	M63 x 1,5	10,0	65	5	o. r.	o. r.	o. r.

PG thread

Part no.	Size PG	Thread length mm	Spanner size mm	Unit	Net EUR/100 items at a purchase of		
					up to 100	101 - 500	501 - 1000
96033	7	5,0	14	100	o. r.	o. r.	o. r.
96034	9	6,0	17	100	o. r.	o. r.	o. r.
96035	11	6,0	20	50	o. r.	o. r.	o. r.
96036	13,5	6,5	22	50	o. r.	o. r.	o. r.
96037	16	6,5	24	50	o. r.	o. r.	o. r.
96038	21	7,0	30	25	o. r.	o. r.	o. r.
96039	29	8,0	40	10	o. r.	o. r.	o. r.
96040	36	9,0	50	10	o. r.	o. r.	o. r.
96041	42	10,0	57	5	o. r.	o. r.	o. r.
96042	48	10,0	64	5	o. r.	o. r.	o. r.

Dimensions and specifications may be changed without prior notice.

o. r. = on request

KVA Sealing insert

Closed



KVA sealing insert closed

Closed sealing inserts made of Soft-PVC suitable for KVA gland bodies.

Material

Soft PVC

Technical data

Temperature range: -20°C up to +105°C

Application

- Plant and machine construction
- Robotics
- Automation technology
- Vehicle construction and shipbuilding
- Railway technology
- Installation technology
- Control cabinet construction

Part no.	Size PG	Size metric	Sealing insert colour	Cable Ø from / to mm	Unit	Net EUR/100 items at a purchase of		
						up to 100	101 - 500	501 - 1000
97087	9	M16 x 1,5	white	-	100	o. r.	o. r.	o. r.
97088	11	-	white	-	100	o. r.	o. r.	o. r.
97089	13,5	M20 x 1,5	white	-	100	o. r.	o. r.	o. r.
97090	16	M25 x 1,5	white	-	50	o. r.	o. r.	o. r.
97091	21	M32 x 1,5	white	-	50	o. r.	o. r.	o. r.
97092	29	M40 x 1,5	white	-	25	o. r.	o. r.	o. r.
97093	36	M50 x 1,5	white	-	25	o. r.	o. r.	o. r.
97094	42	-	white	-	10	o. r.	o. r.	o. r.
97095	48	M63 x 1,5	white	-	10	o. r.	o. r.	o. r.

Dimensions and specifications may be changed without prior notice.

o. r. = on request

KVA Sealing insert

Standard



KVA sealing insert standard

Colour coded sealing inserts made of Soft-PVC suitable for KVA gland bodies.

Application

- Plant and machine construction
- Robotics
- Automation technology
- Vehicle construction and shipbuilding
- Railway technology
- Installation technology
- Control cabinet construction

Material

Soft PVC

Note

* The KVA sealing inserts M12x1,5 (part no. 90299) can be used only with KVA brass cable glands.

* The KVA sealing inserts M12x1,5 (part no. 90291) can be used only with KVA polyamide cable glands.

Technical data

Temperature range: -20°C up to +105°C

Part no.	Size PG	Size metric	Sealing insert colour	Cable Ø from / to mm	Unit	Net EUR/ 100 items at a purchase of		
						up to 100	101 - 500	501 - 1000
96005	7	-	yellow	4,0 - 6,5	100	o. r.	o. r.	o. r.
90299*	-	M12 x 1,5	yellow	4,0 - 6,5	100	o. r.	o. r.	o. r.
90291*	-	M12 x 1,5	yellow	4,0 - 6,5	100	o. r.	o. r.	o. r.
96006	9	M16 x 1,5	yellow	4,0 - 6,5	100	o. r.	o. r.	o. r.
96007	9	M16 x 1,5	grey	5,0 - 8,0	100	o. r.	o. r.	o. r.
96008	9	M16 x 1,5	black	6,5 - 9,5	100	o. r.	o. r.	o. r.
96387	11	M20 x 1,5	yellow	4,0 - 6,5	100	o. r.	o. r.	o. r.
96009	11	M20 x 1,5	grey	5,0 - 8,0	100	o. r.	o. r.	o. r.
96010	11	M20 x 1,5	black	6,5 - 9,5	100	o. r.	o. r.	o. r.
96011	11	M20 x 1,5	green	7,0 - 10,5	100	o. r.	o. r.	o. r.
96389	13,5	M20 x 1,5	yellow	4,0 - 6,5	100	o. r.	o. r.	o. r.
96388	13,5	M20 x 1,5	grey	5,0 - 8,0	100	o. r.	o. r.	o. r.
96012	13,5	M20 x 1,5	black	6,5 - 9,5	100	o. r.	o. r.	o. r.
96013	13,5	M20 x 1,5	green	7,0 - 10,5	100	o. r.	o. r.	o. r.
96014	13,5	M20 x 1,5	red	9,0 - 13,0	100	o. r.	o. r.	o. r.
96391	16	M25 x 1,5	yellow	4,0 - 6,5	50	o. r.	o. r.	o. r.
96390	16	M25 x 1,5	grey	5,0 - 8,0	50	o. r.	o. r.	o. r.
96016	16	M25 x 1,5	black	6,5 - 9,5	50	o. r.	o. r.	o. r.
96017	16	M25 x 1,5	green	7,0 - 10,5	50	o. r.	o. r.	o. r.
96018	16	M25 x 1,5	red	9,0 - 13,0	50	o. r.	o. r.	o. r.
96019	16	M25 x 1,5	white	11,5 - 15,5	50	o. r.	o. r.	o. r.
96020	21	M32 x 1,5	green	7,0 - 10,5	50	o. r.	o. r.	o. r.
96021	21	M32 x 1,5	red	9,0 - 13,0	50	o. r.	o. r.	o. r.
96022	21	M32 x 1,5	white	11,5 - 15,5	50	o. r.	o. r.	o. r.
96023	21	M32 x 1,5	blue	14,0 - 18,0	50	o. r.	o. r.	o. r.
96024	21	M32 x 1,5	brown	17,0 - 21,0	50	o. r.	o. r.	o. r.
96025	29	M40 x 1,5	blue	14,0 - 18,0	25	o. r.	o. r.	o. r.
96026	29	M40 x 1,5	brown	17,0 - 21,0	25	o. r.	o. r.	o. r.
96027	29	M40 x 1,5	orange	20,0 - 25,0	25	o. r.	o. r.	o. r.
96393	29	M40 x 1,5	light yellow	24,0 - 28,0	25	o. r.	o. r.	o. r.
96028	36	M50 x 1,5	anthracite	27,0 - 32,0	25	o. r.	o. r.	o. r.
96029	36	M50 x 1,5	light blue	29,0 - 34,0	25	o. r.	o. r.	o. r.
96030	36	M50 x 1,5	pink	32,0 - 37,0	25	o. r.	o. r.	o. r.
96031	42	M50 x 1,5	white	36,0 - 41,0	10	o. r.	o. r.	o. r.

Dimensions and specifications may be changed without prior notice.

o. r. = on request

KVA MFDE Multiple sealing insert



KVA multiple sealing insert

Multiple sealing inserts made of Soft-PVC for use with KVA gland bodies.

Material

Soft PVC

Technical data

Temperature range: -20°C up to +105°C

Application

- Plant and machine construction
- Robotics
- Automation technology
- Vehicle construction and shipbuilding
- Railway technology
- Installation technology
- Control cabinet construction

Part no.	Size PG	Size metric	Insert colour	Number x Ø borehole mm	Unit	Net EUR/100 items at a purchase of		
						up to 100	101 - 500	501 - 1000
96050	9	M16 x 1,5	white	2 x 1,0	100	o. r.	o. r.	o. r.
96051	9	M16 x 1,5	white	2 x 3,0	100	o. r.	o. r.	o. r.
96052	9	M16 x 1,5	white	4 x 3,0	100	o. r.	o. r.	o. r.
96053	9	M16 x 1,5	white	2 x 4,0	100	o. r.	o. r.	o. r.
96054	9	M16 x 1,5	white	1 x 5,0	100	o. r.	o. r.	o. r.
96055	11	M20 x 1,5	white	6 x 2,0	100	o. r.	o. r.	o. r.
96058	11	M20 x 1,5	white	2 x 3,0	100	o. r.	o. r.	o. r.
96059	11	M20 x 1,5	white	3 x 3,0	100	o. r.	o. r.	o. r.
96485	11	M20 x 1,5	white	2 x 4,0	100	o. r.	o. r.	o. r.
97277	11	M20 x 1,5	white	4 x 4,0	100	o. r.	o. r.	o. r.
96060	11	M20 x 1,5	white	2 x 5,0	100	o. r.	o. r.	o. r.
96062	13,5	M20 x 1,5	white	3 x 2,0	100	o. r.	o. r.	o. r.
96063	13,5	M20 x 1,5	white	10 x 2,0	100	o. r.	o. r.	o. r.
96064	13,5	M20 x 1,5	white	2 x 3,0	100	o. r.	o. r.	o. r.
96065	13,5	M20 x 1,5	white	3 x 3,0	100	o. r.	o. r.	o. r.
96621	13,5	M20 x 1,5	white	3 x 4,0	100	o. r.	o. r.	o. r.
96067	13,5	M20 x 1,5	white	2 x 5,0	100	o. r.	o. r.	o. r.
96068	13,5	M20 x 1,5	white	2 x 6,0	100	o. r.	o. r.	o. r.
96069	16	M25 x 1,5	white	7 x 2,0	50	o. r.	o. r.	o. r.
96438	16	M25 x 1,5	white	3 x 3,0	50	o. r.	o. r.	o. r.
97512	16	M25 x 1,5	white	5 x 3,0	50	o. r.	o. r.	o. r.
97513	16	M25 x 1,5	white	7 x 3,0	50	o. r.	o. r.	o. r.
96436	16	M25 x 1,5	white	8 x 3,0	50	o. r.	o. r.	o. r.
96070	16	M25 x 1,5	white	2 x 4,0	50	o. r.	o. r.	o. r.
97472	16	M25 x 1,5	white	3 x 4,0	50	o. r.	o. r.	o. r.
96071	16	M25 x 1,5	white	4 x 4,0	50	o. r.	o. r.	o. r.
97473	16	M25 x 1,5	white	5 x 4,0	50	o. r.	o. r.	o. r.
96072	16	M25 x 1,5	white	6 x 4,0	50	o. r.	o. r.	o. r.
96073	16	M25 x 1,5	white	2 x 6,0	50	o. r.	o. r.	o. r.
96723	16	M25 x 1,5	white	3 x 6,0	50	o. r.	o. r.	o. r.
96443	16	M25 x 1,5	white	4 x 6,0	50	o. r.	o. r.	o. r.
96074	16	M25 x 1,5	white	3 x 7,0	50	o. r.	o. r.	o. r.
96075	16	M25 x 1,5	white	2 x 8,0	50	o. r.	o. r.	o. r.

Continuation ►

KVA MFDE Multiple sealing insert

Part no.	Size PG	Size metric	Insert colour	Number x Ø borehole mm	Unit	Net EUR/ 100 items at a purchase of		
						up to 100	101 - 500	501 - 1000
96076	21	M32 x 1,5	white	21 x 2,0	50	o. r.	o. r.	o. r.
96077	21	M32 x 1,5	white	8 x 3,0	50	o. r.	o. r.	o. r.
96078	21	M32 x 1,5	white	6 x 4,0	50	o. r.	o. r.	o. r.
96079	21	M32 x 1,5	white	8 x 4,0	50	o. r.	o. r.	o. r.
96080	21	M32 x 1,5	white	4 x 5,0	50	o. r.	o. r.	o. r.
96926	21	M32 x 1,5	white	8 x 5,0	50	o. r.	o. r.	o. r.
96714	21	M32 x 1,5	white	6 x 5,5	25	o. r.	o. r.	o. r.
96439	21	M32 x 1,5	white	2 x 6,0	50	o. r.	o. r.	o. r.
96081	21	M32 x 1,5	white	4 x 6,0	50	o. r.	o. r.	o. r.
96230	21	M32 x 1,5	white	4 x 6,5	50	o. r.	o. r.	o. r.
96231	21	M32 x 1,5	white	5 x 6,5	50	o. r.	o. r.	o. r.
96082	21	M32 x 1,5	white	6 x 6,5	50	o. r.	o. r.	o. r.
96083	21	M32 x 1,5	white	3 x 7,0	50	o. r.	o. r.	o. r.
96441	21	M32 x 1,5	white	4 x 7,0	50	o. r.	o. r.	o. r.
96445	21	M32 x 1,5	white	2 x 8,0	50	o. r.	o. r.	o. r.
96638	21	M32 x 1,5	white	3 x 8,0	25	o. r.	o. r.	o. r.
96084	21	M32 x 1,5	white	4 x 8,0	50	o. r.	o. r.	o. r.
96085	21	M32 x 1,5	white	2 x 9,0	50	o. r.	o. r.	o. r.
96232	21	M32 x 1,5	white	3 x 9,0	50	o. r.	o. r.	o. r.
96088	29	M40 x 1,5	white	6 x 6,0	25	o. r.	o. r.	o. r.
96086	29	M40 x 1,5	white	10 x 6,0	25	o. r.	o. r.	o. r.
96087	29	M40 x 1,5	white	4 x 6,5	25	o. r.	o. r.	o. r.
97289	29	M40 x 1,5	white	8 x 6,5	25	o. r.	o. r.	o. r.
96238	29	M40 x 1,5	white	7 x 7,0	25	o. r.	o. r.	o. r.
96089	29	M40 x 1,5	white	6 x 8,0	25	o. r.	o. r.	o. r.
96090	29	M40 x 1,5	white	4 x 9,0	25	o. r.	o. r.	o. r.
96091	29	M40 x 1,5	white	5 x 9,0	25	o. r.	o. r.	o. r.
96092	29	M40 x 1,5	white	5 x 10,0	25	o. r.	o. r.	o. r.
96093	29	M40 x 1,5	white	2 x 11,0	25	o. r.	o. r.	o. r.
97448	29	M40 x 1,5	white	3 x 11,0	25	o. r.	o. r.	o. r.
96237	29	M40 x 1,5	white	2 x 13,0	25	o. r.	o. r.	o. r.
96095	36	M50 x 1,5	white	15 x 5,0	25	o. r.	o. r.	o. r.
97853	36	M50 x 1,5	white	13 x 7,0	25	o. r.	o. r.	o. r.
96235	36	M50 x 1,5	white	7 x 9,0	25	o. r.	o. r.	o. r.
96094	36	M50 x 1,5	white	8 x 9,0	25	o. r.	o. r.	o. r.
96096	36	M50 x 1,5	white	3 x 10,0	25	o. r.	o. r.	o. r.
96236	36	M50 x 1,5	white	4 x 13,0	25	o. r.	o. r.	o. r.
96097	36	M50 x 1,5	white	2 x 15,0	25	o. r.	o. r.	o. r.

Dimensions and specifications may be changed without prior notice.

o. r. = on request

Matching accessory



Sealing plug

For not assigned penetrations.

refer to page 33

KVA-ASI-MS Cable gland

To ASI-bus-cable



KVA-ASI-MS

Sealing cable gland made of brass with Soft PVC inserts, profile fits to ASI-bus cable.

Application

- Plant and machine construction
- Robotics
- Automation technology
- Installation technology
- Control cabinet construction

Material

Brass
Seal: Soft PVC

Properties

- Large-area cable sealing
- Easy to assemble

Technical data

Protection class: IP 68 - 10 bar

Temperature range: -20°C up to +105°C

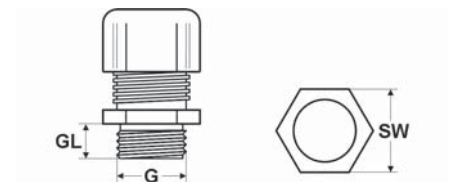

Dimensions

G Thread size
GL Thread length
SW Spanner size

Metric thread

Part no.	Size Metr.	Sealing insert colour	Cable Ø from / to mm	Thread length mm	Spanner size mm	Unit	Net EUR/100 items at a purchase of		
							up to 100	101 - 500	501 - 1000
904686	M20 x 1,5	black, left	-	6,5	22	50	o. r.	o. r.	o. r.
904687	M20 x 1,5	white, right	-	6,5	22	50	o. r.	o. r.	o. r.

PG thread

Part no.	Size PG	Sealing insert colour	Cable Ø from / to mm	Thread length mm	Spanner size mm	Unit	Net EUR/100 items at a purchase of		
							up to 100	101 - 500	501 - 1000
97390	13,5	black, left	-	6,5	22	50	o. r.	o. r.	o. r.
97408	13,5	white, right	-	6,5	22	50	o. r.	o. r.	o. r.

Dimensions and specifications may be changed without prior notice.

o. r. = on request

KVA Sealing insert

To ASI-bus-cable



KVA sealing insert ASI

Sealing inserts made of Soft-PVC for use with KVA gland bodies. Profile fits into ASI-bus cable.

Application

- Plant and machine construction
- Robotics
- Automation technology
- Installation technology
- Control cabinet construction

Material

Soft PVC

Properties

- Large-area cable sealing
- Easy to assemble

Technical data

Temperature range: -20°C up to +105°C

Part no.	Size PG	Size metric	Sealing insert colour	Cable Ø from / to mm	Unit	Net EUR/100 items at a purchase of		
						up to 100	101 - 500	501 - 1000
97389	11	M20 x 1,5	black/left	-	100	o. r.	o. r.	o. r.
97396	11	M20 x 1,5	white/right	-	100	o. r.	o. r.	o. r.

Dimensions and specifications may be changed without prior notice.

o. r. = on request

KVA-XXL-MS Cable gland

For particularly large cable diameters



KVA-XXL-MS

Cable gland made of brass for very large cable diameters.

Application

- Plant and machine construction
- Robotics
- Automation technology
- Vehicle construction and shipbuilding
- Installation technology
- Control cabinet construction

Material

Brass, nickel plated
Seal: TPE-V
O-ring: NBR

Properties

- Large-area cable sealing
- Easy to assemble
- Large clamping range

Technical data

Protection class: IP 68 - 10 bar

Temperature range: -40°C up to +135°C

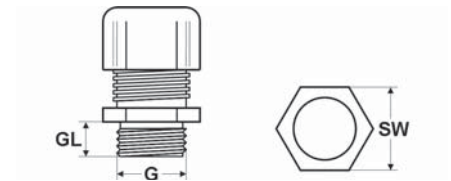

Dimensions

G Thread size
GL Thread length
SW Spanner size

Metric thread

Part no.	Size Metr.	Cable Ø from / to mm	Thread length mm	Spanner size mm	Unit	Net EUR/100 items at a purchase of		
						up to 100	101 - 500	501 - 1000
905957	M63 x 1,5	42,0 - 48,0	10,0	70	1	o. r.	o. r.	o. r.
93569	M63 x 1,5	45,0 - 51,0	10,0	70	1	o. r.	o. r.	o. r.
92779	M72 x 2,0	46,0 - 52,0	15,0	80	1	o. r.	o. r.	o. r.
93727	M72 x 2,0	51,0 - 55,0	15,0	80	1	o. r.	o. r.	o. r.
905958	M75 x 1,5	51,0 - 55,0	15,0	80	1	o. r.	o. r.	o. r.
905959	M75 x 1,5	54,0 - 58,0	15,0	80	1	o. r.	o. r.	o. r.
93105	M80 x 2,0	58,0 - 64,0	15,0	95	1	o. r.	o. r.	o. r.
905960	M80 x 2,0	63,0 - 70,0	15,0	95	1	o. r.	o. r.	o. r.
905961	M90 x 2,0	69,0 - 75,0	20,0	110	1	o. r.	o. r.	o. r.
905962	M90 x 2,0	74,0 - 80,0	20,0	110	1	o. r.	o. r.	o. r.
905963	M100 x 2,0	79,0 - 85,0	20,0	110	1	o. r.	o. r.	o. r.
905964	M105 x 2,0	84,0 - 90,0	20,0	120	1	o. r.	o. r.	o. r.
905965	M110 x 2,0	89,0 - 95,0	20,0	120	1	o. r.	o. r.	o. r.
905966	M115 x 2,0	89,0 - 95,0	20,0	120	1	o. r.	o. r.	o. r.

Dimensions and specifications may be changed without prior notice.

o. r. = on request

KVA-XXL-VK-MS Body gland

For particularly large cable diameter



KVA-XXL-VK-MS

Gland body made of brass suitable for large cable diameters sealing inserts.

Application

- Plant and machine construction
- Robotics
- Automation technology
- Vehicle construction and shipbuilding
- Railway technology
- Installation technology
- Control cabinet construction

Material

Brass, nickel plated
Seal: NBR
O-ring: NBR

Technical data

Temperature range: -30°C up to +100°C

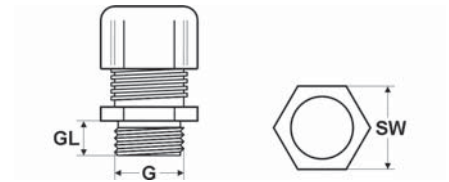

Dimensions

G Thread size
GL Thread length
SW Spanner size

Metric thread

Part no.	Size Metr.	Thread length mm	Spanner size mm	Unit	Net EUR/ 100 items at a purchase of		
					up to 100	101 - 500	501 - 1000
920144	M72 x 2,0	8,0	80	1	o. r.	o. r.	o. r.
920145	M75 x 1,5	8,0	80	1	o. r.	o. r.	o. r.
920146	M80 x 2,0	8,0	95	1	o. r.	o. r.	o. r.

Dimensions and specifications may be changed without prior notice.

o. r. = on request

KVA-XXL Sealing insert standard

For particularly large cable diameters



KVA-XXL sealing insert standard

Sealing PVC inserts which fits in KVA XXL MS gland bodies for large cable diameters.

Material

Soft PVC

Technical data

Temperature range: -20°C up to +105°C

Application

- Plant and machine construction
- Robotics
- Automation technology
- Vehicle construction and shipbuilding
- Railway technology
- Installation technology
- Control cabinet construction

Part no.	Size metric	Sealing insert colour	Cable Ø from / to mm	Unit	Net EUR/100 items at a purchase of		
					up to 100	101 - 500	501 - 1000
96032	M63 x 1,5	white	39,0 - 45,0	1	o. r.	o. r.	o. r.
99434	M72 x 2,0	white	45,0 - 51,0	1	o. r.	o. r.	o. r.
99435	M72 x 2,0	white	51,0 - 55,0	1	o. r.	o. r.	o. r.
99436	M75 x 1,5	white	51,0 - 55,0	1	o. r.	o. r.	o. r.
99437	M75 x 1,5	white	54,0 - 58,0	1	o. r.	o. r.	o. r.
99438	M80 x 2,0	white	58,0 - 64,0	1	o. r.	o. r.	o. r.
99439	M80 x 2,0	white	63,0 - 70,0	1	o. r.	o. r.	o. r.

Dimensions and specifications may be changed without prior notice.

o. r. = on request

SD Cable gland



SD

Gas and watertight gland. The quality is similar to an incision sealing ring and guarantees extensive clamping ranges.

Material

Brass, nickel plated
Seal: NBR
O-ring: NBR

Technical data

Protection class: IP 68 - 5 bar
Temperature range: -40°C up to +100°C

Application

- Plant and machine construction
- Automation and installation technology
- Vehicle construction and shipbuilding

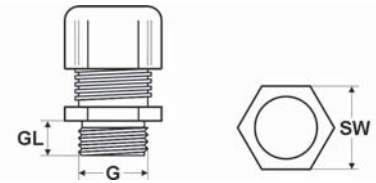

Dimensions

G Thread size
GL Thread length
SW Spanner size

Metric thread

Part no.	Size Metr.	Cable Ø from / to mm	Thread length mm	Spanner size mm	Unit	Net EUR/100 items at a purchase of		
						up to 100	101 - 500	501 - 1000
98108	M12 x 1,5	5,0 - 7,0	5,0	14	100	o. r.	o. r.	o. r.
98109	M16 x 1,5	5,0 - 10,0	5,5	17	50	o. r.	o. r.	o. r.
98110	M20 x 1,5	8,0 - 14,0	6,0	22	50	o. r.	o. r.	o. r.
98111	M25 x 1,5	12,0 - 19,0	7,0	30	25	o. r.	o. r.	o. r.
98112	M32 x 1,5	15,0 - 22,0	8,0	34	25	o. r.	o. r.	o. r.
98113	M40 x 1,5	22,0 - 28,0	8,0	44	10	o. r.	o. r.	o. r.

PG thread

Part no.	Size PG	Cable Ø from / to mm	Thread length mm	Spanner size mm	Unit	Net EUR/100 items at a purchase of		
						up to 100	101 - 500	501 - 1000
90586	7	5,0 - 7,0	5,0	14	100	o. r.	o. r.	o. r.
90587	9	5,0 - 10,0	6,0	17	50	o. r.	o. r.	o. r.
90588	11	5,0 - 10,0	6,0	20	50	o. r.	o. r.	o. r.
90589	13,5	9,0 - 14,0	6,5	22	50	o. r.	o. r.	o. r.
90590	16	10,0 - 15,0	6,5	24	50	o. r.	o. r.	o. r.
90591	21	12,0 - 19,0	7,0	30	25	o. r.	o. r.	o. r.
90592	29	22,0 - 28,0	8,0	40	25	o. r.	o. r.	o. r.
90593	36	28,0 - 36,0	9,0	50	10	o. r.	o. r.	o. r.
90594	42	35,0 - 45,0	10,0	60	10	o. r.	o. r.	o. r.
90595	48	34,0 - 49,0	11,0	65	10	o. r.	o. r.	o. r.

BSP thread

Part no.	Size BSP	Cable Ø from / to mm	Thread length mm	Spanner size mm	Unit	Net EUR/100 items at a purchase of		
						up to 100	101 - 500	501 - 1000
90596	G 3/8"	4,0 - 12,0	6,0	22	50	o. r.	o. r.	o. r.
90597	G 1/2"	7,0 - 15,0	8,0	24	50	o. r.	o. r.	o. r.
90598	G 3/4"	9,0 - 20,0	10,0	32	25	o. r.	o. r.	o. r.
90599	G 1"	18,0 - 28,0	11,0	40	25	o. r.	o. r.	o. r.
90600	G 1 1/2"	25,0 - 35,0	12,0	50	10	o. r.	o. r.	o. r.
90601	G 2"	34,0 - 49,0	12,0	64	5	o. r.	o. r.	o. r.

Dimensions and specifications may be changed without prior notice.

o. r. = on request

SD-XXL Cable gland

For particularly large cable diameters



SD-XXL

Gas and watertight gland for very large cable diameters. The quality is similar to an incision sealing ring and guarantees extensive clamping ranges.

Material

Brass, nickel plated
Seal: NBR
O-ring: NBR

Properties

- Large-area cable sealing
- Easy to assemble
- Large clamping range

Note

BSP-variant: Without O-ring at threaded connection. Sealing insert made of TPE.

Technical data

Protection class: IP 68 - 10 bar

Temperature range: -40°C up to +100°C

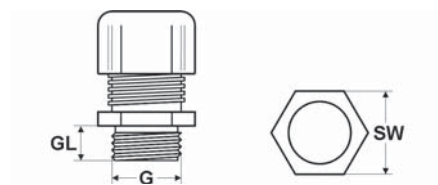

Dimensions

G Thread size
GL Thread length
SW Spanner size

Metric thread

Part no.	Size Metr.	Cable Ø from / to mm	Thread length mm	Spanner size mm	Unit	Net EUR/100 items at a purchase of		
						up to 100	101 - 500	501 - 1000
905570	M72 x 2,0	56,0 - 61,0	16,0	77	1	o. r.	o. r.	o. r.
905506	M75 x 1,5	56,0 - 61,0	16,0	77	1	o. r.	o. r.	o. r.
905571	M75 x 2,0	56,0 - 61,0	16,0	77	1	o. r.	o. r.	o. r.
905573	M80 x 2,0	50,0 - 56,0	18,0	90	1	o. r.	o. r.	o. r.
905572	M80 x 2,0	60,0 - 66,0	18,0	90	1	o. r.	o. r.	o. r.
905575	M85 x 2,0	63,0 - 70,0	22,0	96	1	o. r.	o. r.	o. r.
905574	M85 x 2,0	68,0 - 76,0	22,0	96	1	o. r.	o. r.	o. r.
905576	M90 x 2,0	68,0 - 76,0	22,0	98 / 96	1	o. r.	o. r.	o. r.
905577	M110 x 2,0	75,0 - 82,0	25,0	125 / 110	1	o. r.	o. r.	o. r.
905578	M120 x 2,0	88,0 - 95,0	25,0	120 / 116	1	o. r.	o. r.	o. r.

BSP thread

Part no.	Size BSP	Cable Ø from / to mm	Thread length mm	Spanner size mm	Unit	Net EUR/100 items at a purchase of		
						up to 100	101 - 500	501 - 1000
90604	G 3"	58,0 - 65,0	18,0	100	1	o. r.	o. r.	o. r.
90605	G 3"	63,0 - 70,0	18,0	100	1	o. r.	o. r.	o. r.
90606	G 4"	68,0 - 75,0	22,0	125	1	o. r.	o. r.	o. r.
90607	G 4"	73,0 - 80,0	22,0	125	1	o. r.	o. r.	o. r.
90608	G 4"	78,0 - 85,0	22,0	125	1	o. r.	o. r.	o. r.
90609	G 4"	83,0 - 90,0	22,0	125	1	o. r.	o. r.	o. r.
93440	G 5"	91,0 - 97,0	22,0	150	1	o. r.	o. r.	o. r.
93441	G 5"	97,0 - 104,0	22,0	150	1	o. r.	o. r.	o. r.
93442	G 5"	102,0 - 109,0	22,0	150	1	o. r.	o. r.	o. r.
93443	G 5"	109,0 - 116,0	22,0	150	1	o. r.	o. r.	o. r.

Dimensions and specifications may be changed without prior notice.

o. r. = on request

STS Cable gland to DIN

Hexagonal



STS

Hexagonal brass gland acc. to DIN 46320.

Application

- Plant and machine construction
- Robotics
- Automation technology
- Vehicle construction and shipbuilding
- Railway technology
- Installation technology
- Control cabinet construction

Material

Brass, nickel plated
Seal: NR
Thrust rings: Galvanized steel

Note

Protection classification IP 65 with additional O-ring mounted at the thread.

Technical data

Protection class: IP 54

Temperature range: -20°C up to +60°C

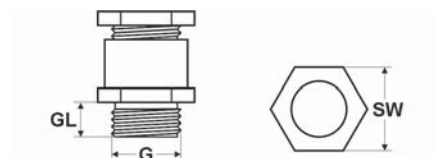

Dimensions

G Thread size
GL Thread length
SW Spanner size

Metric thread

Part no.	Size Metr.	Cable Ø from / to mm	Thread length mm	Spanner size mm	Unit	Net EUR/ 100 items at a purchase of		
						up to 100	101 - 500	501 - 1000
98098	M12 x 1,5	4,0 - 6,0	5,0	14	100	o. r.	o. r.	o. r.
98099	M16 x 1,5	8,0 - 10,0	5,0	18	100	o. r.	o. r.	o. r.
98100	M20 x 1,5	8,0 - 10,0	6,0	22	50	o. r.	o. r.	o. r.
98101	M20 x 1,5	10,0 - 12,0	6,0	22	50	o. r.	o. r.	o. r.
98102	M20 x 1,5	12,0 - 14,0	6,0	24	50	o. r.	o. r.	o. r.
98103	M25 x 1,5	17,0 - 19,0	7,0	30	50	o. r.	o. r.	o. r.
98104	M32 x 1,5	26,0 - 27,0	8,0	39	25	o. r.	o. r.	o. r.
98105	M40 x 1,5	33,0 - 35,0	8,0	50	10	o. r.	o. r.	o. r.
98106	M50 x 1,5	39,0 - 41,0	9,0	57	5	o. r.	o. r.	o. r.
98107	M63 x 1,5	43,0 - 45,0	10,0	66	5	o. r.	o. r.	o. r.

PG thread

Part no.	Size PG	Cable Ø from / to mm	Thread length mm	Spanner size mm	Unit	Net EUR/ 100 items at a purchase of		
						up to 100	101 - 500	501 - 1000
90540	7	6,0 - 8,0	5,0	14 / 13	50	o. r.	o. r.	o. r.
90541	9	8,0 - 10,0	6,0	17 / 15	50	o. r.	o. r.	o. r.
90542	11	10,0 - 12,0	6,0	20 / 18	50	o. r.	o. r.	o. r.
90543	13,5	12,0 - 14,0	6,5	22 / 20	50	o. r.	o. r.	o. r.
90544	16	14,0 - 16,0	6,5	24 / 22	50	o. r.	o. r.	o. r.
90545	21	17,0 - 19,0	7,0	30 / 28	25	o. r.	o. r.	o. r.
90546	29	26,0 - 28,0	8,0	40 / 37	25	o. r.	o. r.	o. r.
90547	36	33,0 - 35,0	9,0	50 / 47	10	o. r.	o. r.	o. r.
90548	42	39,0 - 41,0	10,0	57 / 54	5	o. r.	o. r.	o. r.
90549	48	45,0 - 47,0	10,0	64 / 60	5	o. r.	o. r.	o. r.

Dimensions and specifications may be changed without prior notice.

o. r. = on request

STV Cable gland acc. to DIN

Hexagonal - with incision sealing ring



STV

Hexagonal brass gland with incision sealing ring acc. to DIN 46320.

Application

- Plant and machine construction
- Robotics
- Automation technology
- Vehicle construction and shipbuilding
- Railway technology
- Installation technology
- Control cabinet construction

Material

Brass, nickel plated
Seal: Cutable sealing ring (NR)
Thrust rings: Galvanized steel

Note

Protection classification IP 65 with additional O-ring mounted at the thread.

Technical data

Protection class: IP 54

Temperature range: -30°C up to +80°C

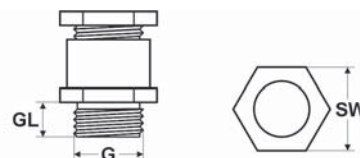

Dimensions

G Thread size
GL Thread length
SW Spanner size

Metric thread

Part no.	Size Metr.	Cable Ø incisions from / to mm	Thread length mm	Spanner size mm	Unit	Net EUR/100 items at a purchase of		
						up to 100	101 - 500	501 - 1000
90090	M16 x 1,5	5/7,5/10	5,0	18	100	o. r.	o. r.	o. r.
90091	M20 x 1,5	7,5/10/12,5	6,0	22	50	o. r.	o. r.	o. r.
90092	M20 x 1,5	7,5/10/12,5/15	6,0	24	50	o. r.	o. r.	o. r.
90093	M25 x 1,5	10/13/16/19	6,0	30	50	o. r.	o. r.	o. r.
90094	M32 x 1,5	18/21/24/27	6,0	39	25	o. r.	o. r.	o. r.
90095	M40 x 1,5	24/27/30/33	7,0	50	10	o. r.	o. r.	o. r.
90096	M50 x 1,5	30/33/36/39	8,0	57	5	o. r.	o. r.	o. r.
90097	M63 x 1,5	36/39/42/45	9,0	66	5	o. r.	o. r.	o. r.

PG thread

Part no.	Size PG	Cable Ø incisions from / to mm	Thread length mm	Spanner size mm	Unit	Net EUR/100 items at a purchase of		
						up to 100	101 - 500	501 - 1000
90550	9	5/7,5/10	6,0	17	100	o. r.	o. r.	o. r.
90551	11	7,5/10/12,5	6,0	20	50	o. r.	o. r.	o. r.
90552	13,5	7,5/10/12,5	6,5	22	50	o. r.	o. r.	o. r.
90553	16	7,5/10/12,5/15	6,5	24	50	o. r.	o. r.	o. r.
90554	21	10/13/16/19	7,0	30	50	o. r.	o. r.	o. r.
90555	29	18/21/24/27	8,0	40	25	o. r.	o. r.	o. r.
90556	36	24/27/30/33	9,0	50	20	o. r.	o. r.	o. r.
90557	42	30/33/36/39	10,0	57	10	o. r.	o. r.	o. r.
90558	48	36/39/42/45	10,0	64	5	o. r.	o. r.	o. r.

Dimensions and specifications may be changed without prior notice.

o. r. = on request

STR Cable gland acc. to DIN

Round



STR

Round brass gland acc. to DIN 46320.

Application

- Plant and machine construction
- Robotics
- Automation technology
- Vehicle construction and shipbuilding
- Railway technology
- Installation technology
- Control cabinet construction

Material

Brass, nickel plated
Seal: NR

Note

Protection classification IP 65 with additional O-ring mounted at the thread.

Technical data

Protection class: IP 54

Temperature range: -30°C up to +80°C

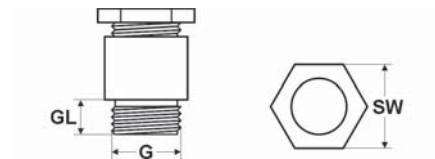

Dimensions

G Thread size
GL Thread length
SW Spanner size

Metric thread

Part no.	Size Metr.	Cable Ø from / to mm	Thread length mm	Spanner size mm	Unit	Net EUR/ 100 items at a purchase of		
						up to 100	101 - 500	501 - 1000
98088	M12 x 1,5	4,0 - 6,0	5,0	13	100	o. r.	o. r.	o. r.
98089	M16 x 1,5	8,0 - 10,0	5,0	15	100	o. r.	o. r.	o. r.
98090	M20 x 1,5	8,0 - 10,0	6,0	18	50	o. r.	o. r.	o. r.
98091	M20 x 1,5	10,0 - 12,0	6,0	20	50	o. r.	o. r.	o. r.
98092	M20 x 1,5	12,0 - 14,0	6,0	22	50	o. r.	o. r.	o. r.
98093	M25 x 1,5	17,0 - 19,0	6,0	28	50	o. r.	o. r.	o. r.
98094	M32 x 1,5	26,0 - 27,0	6,0	37	25	o. r.	o. r.	o. r.
98095	M40 x 1,5	33,0 - 35,0	7,0	47	10	o. r.	o. r.	o. r.
98096	M50 x 1,5	39,0 - 41,0	8,0	54	5	o. r.	o. r.	o. r.
98097	M63 x 1,5	43,0 - 45,0	9,0	60	5	o. r.	o. r.	o. r.

PG thread

Part no.	Size PG	Cable Ø from / to mm	Thread length mm	Spanner size mm	Unit	Net EUR/ 100 items at a purchase of		
						up to 100	101 - 500	501 - 1000
90530	7	4,0 - 6,0	5,0	13	50	o. r.	o. r.	o. r.
90531	9	8,0 - 10,0	6,0	15	50	o. r.	o. r.	o. r.
90532	11	8,0 - 10,0	6,0	18	50	o. r.	o. r.	o. r.
90533	13,5	10,0 - 12,0	6,5	20	50	o. r.	o. r.	o. r.
90534	16	12,0 - 14,0	6,5	22	50	o. r.	o. r.	o. r.
90535	21	17,0 - 19,0	7,0	28	25	o. r.	o. r.	o. r.
90536	29	26,0 - 28,0	8,0	37	25	o. r.	o. r.	o. r.
90537	36	33,0 - 35,0	9,0	47	10	o. r.	o. r.	o. r.
90538	42	39,0 - 41,0	10,0	54	5	o. r.	o. r.	o. r.
90539	48	45,0 - 47,0	10,0	60	5	o. r.	o. r.	o. r.

Dimensions and specifications may be changed without prior notice.

o. r. = on request

STS-F Flat cable gland



STS-F

Brass gland for flat cables.

Application

- Plant and machine construction
- Robotics
- Automation technology
- Vehicle construction and shipbuilding
- Railway technology
- Installation technology
- Control cabinet construction

Material

Brass, nickel plated
Seal: SBR
Thrust washers: Galvanized steel

Note

Protection classification IP 65 with an additional O-ring on the external thread.

Technical data

Protection class: IP 54

Temperature range: -30°C up to +80°C

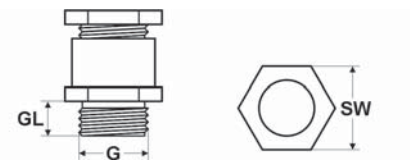

Dimensions

G Thread size
GL Thread length
SW Spanner size

Metric thread

Part no.	Size Metr.	Cable thickness from / to mm	Cable width from / to mm	Thread length mm	Spanner size mm	Unit	Net EUR/100 items at a purchase of		
							up to 100	101 - 500	501 - 1000
94484	M20 x 1,5	1,0 - 5,0	3,0 - 16,0	6,0	24 / 22	50	o. r.	o. r.	o. r.
94485	M25 x 1,5	3,0 - 8,0	9,0 - 21,0	7,0	30 / 28	50	o. r.	o. r.	o. r.
94486	M32 x 1,5	4,0 - 11,5	14,0 - 30,0	8,0	39 / 37	25	o. r.	o. r.	o. r.
94487	M40 x 1,5	4,0 - 11,5	24,0 - 40,0	8,0	50 / 47	10	o. r.	o. r.	o. r.
94488	M50 x 1,5	5,0 - 12,0	29,0 - 45,0	9,0	57 / 54	5	o. r.	o. r.	o. r.
94489	M63 x 1,5	5,0 - 12,0	34,0 - 50,0	10,0	66 / 60	5	o. r.	o. r.	o. r.

PG thread

Part no.	Size PG	Cable thickness from / to mm	Cable width from / to mm	Thread length mm	Spanner size mm	Unit	Net EUR/100 items at a purchase of		
							up to 100	101 - 500	501 - 1000
90100	16	1,0 - 5,0	3,0 - 16,0	6,5	24 / 22	50	o. r.	o. r.	o. r.
90101	21	3,0 - 8,0	9,0 - 21,0	7,0	30 / 28	50	o. r.	o. r.	o. r.
90102	29	4,0 - 11,5	14,0 - 30,0	8,0	40 / 37	25	o. r.	o. r.	o. r.
90103	36	4,0 - 11,5	24,0 - 40,0	9,0	50 / 47	20	o. r.	o. r.	o. r.
90104	42	5,0 - 12,0	29,0 - 45,0	10,0	57 / 54	10	o. r.	o. r.	o. r.
90105	48	5,0 - 12,0	34,0 - 50,0	10,0	64 / 60	5	o. r.	o. r.	o. r.

Dimensions and specifications may be changed without prior notice.

o. r. = on request



ZE
As relieving strain for cables.

Material
Brass, nickel plated

Technical data
Temperature range: up to +200°C

Application

- Plant and machine construction
- Robotics
- Automation technology
- Vehicle construction and shipbuilding
- Railway technology
- Installation technology
- Control cabinet construction

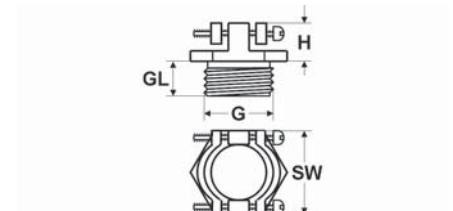

Dimensions

- G Thread size
- GL Thread length
- SW Spanner size
- H Height without thread

Metric thread

Part no.	Size Metr.	Thread length mm	Spanner size mm	Height mm	Unit	Net EUR/ 100 items at a purchase of		
						up to 100	101 - 500	501 - 1000
905877	M12 x 1,5	5,5	16	9,5	100	o. r.	o. r.	o. r.
905878	M16 x 1,5	6,0	19	10,0	100	o. r.	o. r.	o. r.
905879	M20 x 1,5	6,5	24	11,5	50	o. r.	o. r.	o. r.
905880	M25 x 1,5	8,0	34	13,0	50	o. r.	o. r.	o. r.
905881	M32 x 1,5	8,0	42	14,0	25	o. r.	o. r.	o. r.
905882	M40 x 1,5	9,5	52	16,0	25	o. r.	o. r.	o. r.
905883	M50 x 1,5	9,5	52	16,0	10	o. r.	o. r.	o. r.

PG thread

Part no.	Size PG	Thread length mm	Spanner size mm	Height mm	Unit	Net EUR/ 100 items at a purchase of		
						up to 100	101 - 500	501 - 1000
99049	7	5,5	16	9,3	100	o. r.	o. r.	o. r.
99050	9	6,0	19	10,6	100	o. r.	o. r.	o. r.
99051	11	6,0	22	10,7	100	o. r.	o. r.	o. r.
99052	13,5	6,5	24	11,3	50	o. r.	o. r.	o. r.
99053	16	6,5	26	11,8	50	o. r.	o. r.	o. r.
99054	21	7,5	33	13,3	50	o. r.	o. r.	o. r.
99055	29	8,0	42	13,8	25	o. r.	o. r.	o. r.
99056	36	9,5	52	15,8	10	o. r.	o. r.	o. r.
99057	42	10,0	59	16,3	10	o. r.	o. r.	o. r.
99058	48	11,0	64	16,3	10	o. r.	o. r.	o. r.

Dimensions and specifications may be changed without prior notice.

o. r. = on request

ZES Cable gland

With strain relief and incision sealing ring



ZES

Hexagonal brass strain relief gland with incision sealing ring.

Material

Brass, nickel plated
Seal: NBR
Thrust rings: Galvanized steel

Technical data

Protection class: IP 54
Temperature range: -20°C up to +60°C

Application

- Plant and machine construction
- Robotics
- Automation technology
- Vehicle construction and shipbuilding
- Railway technology
- Installation technology
- Control cabinet construction

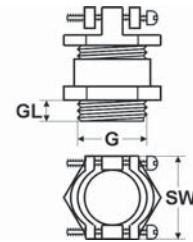

Dimensions

G Thread size
GL Thread length
SW Spanner size

Metric thread

Part no.	Size Metr.	Cable Ø incisions from / to mm	Thread length mm	Spanner size mm	Unit	Net EUR/ 100 items at a purchase of		
						up to 100	101 - 500	501 - 1000
90275	M12 x 1,5	5/7	5,0	14	50	o. r.	o. r.	o. r.
90276	M16 x 1,5	5,5/9	5,0	18	50	o. r.	o. r.	o. r.
90278	M20 x 1,5	7/10/13	6,0	22	50	o. r.	o. r.	o. r.
908421	M20 x 1,5	7/10/13	6,0	24	50	o. r.	o. r.	o. r.
908422	M25 x 1,5	11/14/17	7,0	30	25	o. r.	o. r.	o. r.
908423	M32 x 1,5	19/21/24	8,0	39	20	o. r.	o. r.	o. r.
90282	M40 x 1,5	26/29/32	8,0	50	10	o. r.	o. r.	o. r.
90283	M50 x 1,5	35/38/41	9,0	57	5	o. r.	o. r.	o. r.
90284	M63 x 1,5	44/47/50	10,0	66	5	o. r.	o. r.	o. r.

PG thread

Part no.	Size PG	Cable Ø incisions from / to mm	Thread length mm	Spanner size mm	Unit	Net EUR/ 100 items at a purchase of		
						up to 100	101 - 500	501 - 1000
90569	7	7	5,0	14	50	o. r.	o. r.	o. r.
90570	9	5/7,5/10	6,0	17	50	o. r.	o. r.	o. r.
90571	11	7,5/10/12,5	6,0	20	50	o. r.	o. r.	o. r.
90572	13,5	7,5/10/12,5	6,5	22	50	o. r.	o. r.	o. r.
90573	16	7,5/10/12,5/15	6,5	24	50	o. r.	o. r.	o. r.
90574	21	10/13/16/19	7,0	30	25	o. r.	o. r.	o. r.
90575	29	18/21/24/27	8,0	40	25	o. r.	o. r.	o. r.
90576	36	24/27/30/33	9,0	50	10	o. r.	o. r.	o. r.
90577	42	30/33/36/39	10,0	57	5	o. r.	o. r.	o. r.
90578	48	36/39/42/45	10,0	64	5	o. r.	o. r.	o. r.

Dimensions and specifications may be changed without prior notice.

o. r. = on request



ZEI

Strain relief with female thread. For strain relief of cables and wires or rather when using protection tubes.

Material

Brass, nickel plated

Technical data

Temperature range: up to +200°C

Application

- Plant and machine construction
- Robotics
- Automation technology
- Vehicle construction and shipbuilding
- Railway technology
- Installation technology
- Control cabinet construction

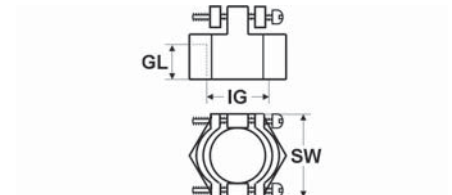

Dimensions

- IG Thread size inside
- GL Thread length
- SW Spanner size

PG thread - female

Part no.	Size PG	Thread length mm	Spanner size mm	Unit	Net EUR/100 items at a purchase of		
					up to 100	101 - 500	501 - 1000
94240	7	7,0	16	100	o. r.	o. r.	o. r.
94241	9	7,0	19	100	o. r.	o. r.	o. r.
94242	11	7,0	22	100	o. r.	o. r.	o. r.
94244	16	7,0	26	50	o. r.	o. r.	o. r.
94245	21	10,0	33	25	o. r.	o. r.	o. r.
94246	29	10,0	42	10	o. r.	o. r.	o. r.
94247	36	10,0	52	10	o. r.	o. r.	o. r.

Dimensions and specifications may be changed without prior notice.

o. r. = on request

Adapter hexagonal



Adapter hexagonal brass

Hexagonal brass adapter for thread adjustment from metric to PG and NPT.

Material

Brass, nickel plated

Technical data

Temperature range: up to +200°C

Application

- Plant and machine construction
- Robotics
- Automation technology
- Vehicle construction and shipbuilding
- Railway technology
- Installation technology
- Control cabinet construction

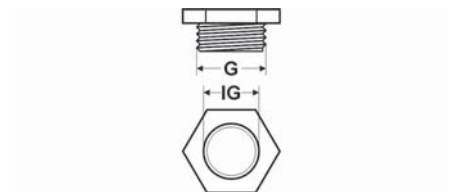

Dimensions

G Thread size outside
 IG Thread size inside
 GL Thread length
 SW Spanner size

From metric to PG

Part no.	Size metr. outside	Size PG inside	Thread length mm	Spanner size mm	Unit	Net EUR/100 items at a purchase of		
						up to 100	101 - 500	501 - 1000
904296	M16 x 1,5	7	6,5	17	100	o. r.	o. r.	o. r.
904297	M20 x 1,5	7	7,0	22	50	o. r.	o. r.	o. r.
904298	M20 x 1,5	9	7,0	22	50	o. r.	o. r.	o. r.
904299	M25 x 1,5	9	7,5	27	50	o. r.	o. r.	o. r.
904300	M25 x 1,5	11	7,5	27	50	o. r.	o. r.	o. r.
904301	M25 x 1,5	13,5	7,5	27	50	o. r.	o. r.	o. r.
904302	M25 x 1,5	16	7,5	27	50	o. r.	o. r.	o. r.
904303	M32 x 1,5	13,5	8,0	35	25	o. r.	o. r.	o. r.
904304	M32 x 1,5	16	8,0	35	25	o. r.	o. r.	o. r.
904305	M32 x 1,5	21	8,0	35	25	o. r.	o. r.	o. r.
904306	M40 x 1,5	16	8,0	43	10	o. r.	o. r.	o. r.
904307	M40 x 1,5	21	8,0	43	10	o. r.	o. r.	o. r.
904308	M50 x 1,5	21	10,0	54	10	o. r.	o. r.	o. r.
904309	M50 x 1,5	29	10,0	54	10	o. r.	o. r.	o. r.
904310	M63 x 1,5	29	10,0	65	5	o. r.	o. r.	o. r.
904311	M63 x 1,5	36	10,0	65	5	o. r.	o. r.	o. r.
904312	M63 x 1,5	42	10,0	65	5	o. r.	o. r.	o. r.

Continuation ►

Adapter hexagonal

From metric to PG - high-profile design

Part no.	Size metr. outside	Size PG inside	Thread length mm	Spanner size mm	Unit	Net EUR/ 100 items at a purchase of		
						up to 100	101 - 500	501 - 1000
904313	M12 x 1,5	7	5,0	14	100	o. r.	o. r.	o. r.
904314	M12 x 1,5	9	6,0	17	100	o. r.	o. r.	o. r.
904315	M16 x 1,5	9	6,0	18	100	o. r.	o. r.	o. r.
904316	M16 x 1,5	11	5,0	20	100	o. r.	o. r.	o. r.
904317	M20 x 1,5	11	6,0	22	100	o. r.	o. r.	o. r.
904318	M20 x 1,5	13,5	6,5	22	100	o. r.	o. r.	o. r.
904319	M20 x 1,5	16	6,5	24	100	o. r.	o. r.	o. r.
904320	M25 x 1,5	21	7,0	30	50	o. r.	o. r.	o. r.
904321	M32 x 1,5	29	8,0	40	25	o. r.	o. r.	o. r.
904322	M40 x 1,5	29	8,0	43	25	o. r.	o. r.	o. r.
904323	M40 x 1,5	36	9,0	50	25	o. r.	o. r.	o. r.
904324	M50 x 1,5	36	10,0	54	10	o. r.	o. r.	o. r.
904325	M50 x 1,5	42	10,0	57	10	o. r.	o. r.	o. r.
904326	M63 x 1,5	48	10,0	66	5	o. r.	o. r.	o. r.

From metric to NPT - high-profile design

Part no.	Size metr. outside	Size NPT inside	Thread length mm	Spanner size mm	Unit	Net EUR/ 100 items at a purchase of		
						up to 100	101 - 500	501 - 1000
94166	M16 x 1,5	1/2"	6,0	24	50	o. r.	o. r.	o. r.
94167	M20 x 1,5	1/2"	6,0	24	50	o. r.	o. r.	o. r.
94168	M25 x 1,5	1/2"	7,0	30	50	o. r.	o. r.	o. r.
94169	M25 x 1,5	3/4"	7,0	30	50	o. r.	o. r.	o. r.

From PG to metric

Part no.	Size PG outside	Size metr. inside	Thread length mm	Spanner size mm	Unit	Net EUR/ 100 items at a purchase of		
						up to 100	101 - 500	501 - 1000
904327	13,5	M16 x 1,5	6,5	24	50	o. r.	o. r.	o. r.
904328	16	M20 x 1,5	6,5	24	50	o. r.	o. r.	o. r.
904329	21	M25 x 1,5	7,0	30	25	o. r.	o. r.	o. r.
904330	29	M32 x 1,5	8,0	40	10	o. r.	o. r.	o. r.
904331	36	M40 x 1,5	9,0	50	10	o. r.	o. r.	o. r.

From PG to metric - high profile design

Part no.	Size PG outside	Size metr. inside	Thread length mm	Spanner size mm	Unit	Net EUR/ 100 items at a purchase of		
						up to 100	101 - 500	501 - 1000
904332	7	M12 x 1,5	5,0	14	100	o. r.	o. r.	o. r.
904333	9	M16 x 1,5	6,0	19	100	o. r.	o. r.	o. r.
904334	11	M16 x 1,5	6,0	22	50	o. r.	o. r.	o. r.
904335	13,5	M20 x 1,5	6,5	24	50	o. r.	o. r.	o. r.
904336	16	M20 x 1,5	6,5	27	50	o. r.	o. r.	o. r.
904337	16	M25 x 1,5	6,5	30	50	o. r.	o. r.	o. r.
904338	21	M25 x 1,5	7,0	32	50	o. r.	o. r.	o. r.
904339	21	M32 x 1,5	7,0	36	25	o. r.	o. r.	o. r.
904340	29	M40 x 1,5	8,0	43	25	o. r.	o. r.	o. r.
904341	36	M50 x 1,5	9,0	55	10	o. r.	o. r.	o. r.
904342	42	M63 x 1,5	10,0	65	10	o. r.	o. r.	o. r.

From PG to NPT - high profile design

Part no.	Size PG outside	Size NPT inside	Thread length mm	Spanner size mm	Unit	Net EUR/ 100 items at a purchase of		
						up to 100	101 - 500	501 - 1000
94174	11	1/2"	6,0	24	50	o. r.	o. r.	o. r.
94175	13,5	1/2"	6,5	24	50	o. r.	o. r.	o. r.
94176	16	1/2"	6,5	24	50	o. r.	o. r.	o. r.
94177	21	1/2"	7,0	30	50	o. r.	o. r.	o. r.
94178	21	3/4"	7,0	30	25	o. r.	o. r.	o. r.

Dimensions and specifications may be changed without prior notice.

o. r. = on request

Adapter round



Adapter round brass

Round brass adapter for thread adjustment from metric to PG and NPT.

Material

Brass, nickel plated

Technical data

Temperature range: up to +200°C

Application

- Plant and machine construction
- Robotics
- Automation technology
- Vehicle construction and shipbuilding
- Railway technology
- Installation technology
- Control cabinet construction

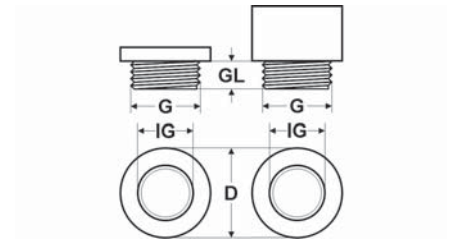

Dimensions

- G Thread size outside
- IG Thread size inside
- GL Thread length
- D Outer diameter

From metric to PG

Part no.	Size metr. outside	Size PG inside	Thread length mm	Outer Ø mm	Unit	Net EUR/100 items at a purchase of		
						up to 100	101 - 500	501 - 1000
904343	M16 x 1,5	7	6,5	18,0	100	o. r.	o. r.	o. r.
904344	M20 x 1,5	7	7,0	22,0	50	o. r.	o. r.	o. r.
904345	M20 x 1,5	9	7,0	22,0	50	o. r.	o. r.	o. r.
904346	M25 x 1,5	9	7,5	27,0	50	o. r.	o. r.	o. r.
904347	M25 x 1,5	11	7,5	27,0	50	o. r.	o. r.	o. r.
904348	M25 x 1,5	13,5	7,5	27,0	50	o. r.	o. r.	o. r.
904349	M25 x 1,5	16	7,5	27,0	50	o. r.	o. r.	o. r.
904350	M32 x 1,5	13,5	8,0	34,0	25	o. r.	o. r.	o. r.
904351	M32 x 1,5	16	8,0	34,0	25	o. r.	o. r.	o. r.
904352	M32 x 1,5	21	8,0	34,0	25	o. r.	o. r.	o. r.
904353	M40 x 1,5	16	8,0	43,0	10	o. r.	o. r.	o. r.
904354	M40 x 1,5	21	8,0	43,0	10	o. r.	o. r.	o. r.
904355	M50 x 1,5	21	9,0	53,0	10	o. r.	o. r.	o. r.
904356	M50 x 1,5	29	9,0	53,0	10	o. r.	o. r.	o. r.
904357	M63 x 1,5	29	10,0	66,0	5	o. r.	o. r.	o. r.
904358	M63 x 1,5	36	10,0	66,0	5	o. r.	o. r.	o. r.
904359	M63 x 1,5	42	10,0	66,0	5	o. r.	o. r.	o. r.

Continuation ►

Adapter round

From metric to PG - high-profile design

Part no.	Size metr. outside	Size PG inside	Thread length mm	Outer Ø mm	Unit	Net EUR/ 100 items at a purchase of		
						up to 100	101 - 500	501 - 1000
904360	M12 x 1,5	7	5,0	14,0	100	o. r.	o. r.	o. r.
904361	M12 x 1,5	9	6,0	18,0	100	o. r.	o. r.	o. r.
904362	M16 x 1,5	9	5,0	18,0	100	o. r.	o. r.	o. r.
904363	M16 x 1,5	11	5,0	20,0	100	o. r.	o. r.	o. r.
904364	M20 x 1,5	11	6,0	22,0	100	o. r.	o. r.	o. r.
904365	M20 x 1,5	13,5	6,0	22,0	100	o. r.	o. r.	o. r.
904366	M20 x 1,5	16	6,0	24,0	100	o. r.	o. r.	o. r.
904367	M25 x 1,5	21	7,0	30,0	50	o. r.	o. r.	o. r.
904368	M32 x 1,5	29	8,0	39,0	50	o. r.	o. r.	o. r.
904369	M40 x 1,5	29	8,0	43,0	10	o. r.	o. r.	o. r.
904370	M40 x 1,5	36	8,0	50,0	25	o. r.	o. r.	o. r.
904371	M50 x 1,5	36	9,0	53,0	10	o. r.	o. r.	o. r.
904372	M50 x 1,5	42	9,0	57,0	25	o. r.	o. r.	o. r.
904373	M63 x 1,5	48	10,0	68,0	10	o. r.	o. r.	o. r.

From PG to metric

Part no.	Size PG outside	Size metr. inside	Thread length mm	Outer Ø mm	Unit	Net EUR/ 100 items at a purchase of		
						up to 100	101 - 500	501 - 1000
904374	11	M20 x 1,5	6,0	22,0	100	o. r.	o. r.	o. r.
904375	13,5	M20 x 1,5	6,5	24,0	50	o. r.	o. r.	o. r.
94098	16	M20 x 1,5	6,5	24,0	50	o. r.	o. r.	o. r.
94102	21	M25 x 1,5	7,0	30,0	100	o. r.	o. r.	o. r.

From PG to metric - high-profile design

Part no.	Size PG outside	Size metr. inside	Thread length mm	Outer Ø mm	Unit	Net EUR/ 100 items at a purchase of		
						up to 100	101 - 500	501 - 1000
904376	9	M16 x 1,5	6,0	20,0	100	o. r.	o. r.	o. r.
904377	11	M20 x 1,5	6,5	22,0	100	o. r.	o. r.	o. r.
904378	13,5	M20 x 1,5	6,5	22,0	100	o. r.	o. r.	o. r.
904379	16	M25 x 1,5	6,5	27,0	50	o. r.	o. r.	o. r.

Dimensions and specifications may be changed without prior notice.

o. r. = on request

EW round Extender



EW round

Brass extender. Transition from small to large thread.

Material

Brass, nickel plated

Technical data

Temperature range: up to +200°C

Application

- Plant and machine construction
- Robotics
- Automation technology
- Vehicle construction and shipbuilding
- Railway technology
- Installation technology
- Control cabinet construction

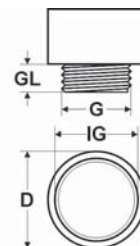

Dimensions

- G Thread size outside
- IG Thread size inside
- GL Thread length
- D Outer diameter

From metric to metric

Part no.	Size metr. outside	Size metr. inside	Thread length mm	Outer Ø mm	Unit	Net EUR/100 items at a purchase of		
						up to 100	101 - 500	501 - 1000
94064	M12 x 1,5	M16 x 1,5	5,0	18,0	100	o. r.	o. r.	o. r.
94066	M16 x 1,5	M20 x 1,5	5,0	22,0	100	o. r.	o. r.	o. r.
94069	M20 x 1,5	M25 x 1,5	6,0	27,0	50	o. r.	o. r.	o. r.
94072	M25 x 1,5	M32 x 1,5	7,0	34,0	50	o. r.	o. r.	o. r.
94075	M32 x 1,5	M40 x 1,5	8,0	42,0	50	o. r.	o. r.	o. r.
94078	M40 x 1,5	M50 x 1,5	8,0	52,0	25	o. r.	o. r.	o. r.
94081	M50 x 1,5	M63 x 1,5	9,0	66,0	10	o. r.	o. r.	o. r.

From PG to PG

Part no.	Size PG outside	Size PG inside	Thread length mm	Outer Ø mm	Unit	Net EUR/100 items at a purchase of		
						up to 100	101 - 500	501 - 1000
90630	7	9	5,0	17,0	100	o. r.	o. r.	o. r.
90631	9	11	6,0	20,0	100	o. r.	o. r.	o. r.
90632	9	13,5	6,0	22,0	100	o. r.	o. r.	o. r.
90633	11	13,5	6,0	22,0	100	o. r.	o. r.	o. r.
90634	11	16	6,0	24,0	50	o. r.	o. r.	o. r.
90635	13,5	16	6,5	24,0	50	o. r.	o. r.	o. r.
90636	13,5	21	6,5	30,0	25	o. r.	o. r.	o. r.
90637	16	21	6,5	30,0	25	o. r.	o. r.	o. r.
90638	21	29	7,0	39,0	100	o. r.	o. r.	o. r.
90639	29	36	8,0	50,0	50	o. r.	o. r.	o. r.
90640	36	42	9,0	57,0	25	o. r.	o. r.	o. r.
90641	42	48	10,0	64,0	10	o. r.	o. r.	o. r.

Dimensions and specifications may be changed without prior notice.

o. r. = on request

RE hexagonal Reducer



RE hexagonal brass

Brass reducer. Transition from large to small thread.

Material

Brass, nickel plated

Technical data

Temperature range: up to +200°C

Application

- Plant and machine construction
- Automation technology
- Vehicle construction and shipbuilding
- Installation technology

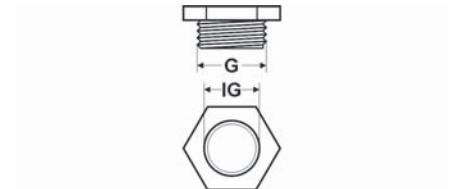

Abmessungen

- G Thread size outside
- IG Thread size inside
- GL Thread length
- SW Spanner size

From metric to metric

Part no.	Size metr. outside	Size metr. inside	Thread length mm	Spanner size mm	Unit	Net EUR/100 items at a purchase of		
						up to 100	101 - 500	501 - 1000
904380	M16 x 1,5	M12 x 1,5	6,5	17	100	o. r.	o. r.	o. r.
904381	M20 x 1,5	M12 x 1,5	7,0	22	50	o. r.	o. r.	o. r.
904382	M20 x 1,5	M16 x 1,5	7,0	22	50	o. r.	o. r.	o. r.
904383	M25 x 1,5	M16 x 1,5	7,5	27	50	o. r.	o. r.	o. r.
904384	M25 x 1,5	M20 x 1,5	7,5	27	50	o. r.	o. r.	o. r.
94073	M32 x 1,5	M20 x 1,5	8,0	35	25	o. r.	o. r.	o. r.
94946	M32 x 1,5	M25 x 1,5	8,0	35	25	o. r.	o. r.	o. r.
94076	M40 x 1,5	M25 x 1,5	8,0	43	10	o. r.	o. r.	o. r.
90909	M40 x 1,5	M32 x 1,5	8,0	43	10	o. r.	o. r.	o. r.
904385	M50 x 1,5	M32 x 1,5	10,0	54	10	o. r.	o. r.	o. r.
90865	M50 x 1,5	M40 x 1,5	10,0	54	10	o. r.	o. r.	o. r.
94947	M63 x 1,5	M40 x 1,5	10,0	65	5	o. r.	o. r.	o. r.
904386	M63 x 1,5	M50 x 1,5	10,0	65	5	o. r.	o. r.	o. r.

Continuation ►

RE hexagonal Reducer

From PG to PG

Part no.	Size PG outside	Size PG inside	Thread length mm	Spanner size mm	Unit	Net EUR/ 100 items at a purchase of		
						up to 100	101 - 500	501 - 1000
904387	9	7	6,0	17	100	o. r.	o. r.	o. r.
904388	11	7	6,0	20	100	o. r.	o. r.	o. r.
904389	11	9	6,0	20	100	o. r.	o. r.	o. r.
904390	13,5	7	6,0	22	50	o. r.	o. r.	o. r.
904391	13,5	9	6,5	22	100	o. r.	o. r.	o. r.
904392	13,5	11	6,5	22	100	o. r.	o. r.	o. r.
904393	16	7	6,5	24	50	o. r.	o. r.	o. r.
904394	16	9	6,5	24	100	o. r.	o. r.	o. r.
904395	16	11	6,5	24	100	o. r.	o. r.	o. r.
904396	16	13,5	6,5	24	100	o. r.	o. r.	o. r.
904397	21	11	7,0	30	100	o. r.	o. r.	o. r.
904398	21	13,5	7,0	30	50	o. r.	o. r.	o. r.
904399	21	16	7,0	30	50	o. r.	o. r.	o. r.
92888	29	16	8,0	40	50	o. r.	o. r.	o. r.
904400	29	21	8,0	40	50	o. r.	o. r.	o. r.
904401	36	21	9,0	50	25	o. r.	o. r.	o. r.
904402	36	29	9,0	50	25	o. r.	o. r.	o. r.
904403	42	29	10,0	57	25	o. r.	o. r.	o. r.
904404	42	36	10,0	57	25	o. r.	o. r.	o. r.
904405	48	36	10,0	64	25	o. r.	o. r.	o. r.
904406	48	42	10,0	64	25	o. r.	o. r.	o. r.

Dimensions and specifications may be changed without prior notice.

o. r. = on request

RE round Reducer



RE round brass

Brass reducer. Transition from large to small thread.

Material

Brass, nickel plated

Technical data

Temperature range: up to +200°C

Application

- Plant and machine construction
- Robotics
- Automation technology
- Vehicle construction and shipbuilding
- Installation technology
- Control cabinet construction

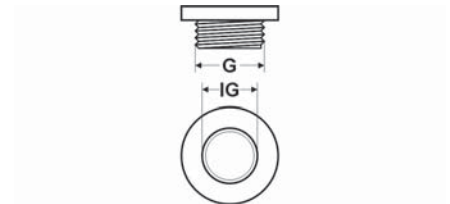

Dimensions

- G Thread size outside
- IG Thread size inside
- GL Thread length
- D Outer diameter

From metric to metric

Part no.	Size metr. outside	Size metr. inside	Thread length mm	Outer Ø mm	Unit	Net EUR/ 100 items at a purchase of		
						up to 100	101 - 500	501 - 1000
94065	M16 x 1,5	M12 x 1,5	5,0	18,0	100	o. r.	o. r.	o. r.
94067	M20 x 1,5	M12 x 1,5	6,0	22,0	100	o. r.	o. r.	o. r.
94068	M20 x 1,5	M16 x 1,5	6,0	22,0	100	o. r.	o. r.	o. r.
94070	M25 x 1,5	M16 x 1,5	7,0	27,0	50	o. r.	o. r.	o. r.
904407	M25 x 1,5	M20 x 1,5	7,0	27,0	100	o. r.	o. r.	o. r.
904408	M32 x 1,5	M20 x 1,5	8,0	34,0	25	o. r.	o. r.	o. r.
94074	M32 x 1,5	M25 x 1,5	8,0	34,0	50	o. r.	o. r.	o. r.
904409	M40 x 1,5	M25 x 1,5	8,0	43,0	25	o. r.	o. r.	o. r.
94077	M40 x 1,5	M32 x 1,5	8,0	43,0	25	o. r.	o. r.	o. r.
94079	M50 x 1,5	M32 x 1,5	9,0	53,0	10	o. r.	o. r.	o. r.
94080	M50 x 1,5	M40 x 1,5	9,0	53,0	25	o. r.	o. r.	o. r.
94082	M63 x 1,5	M40 x 1,5	10,0	66,0	10	o. r.	o. r.	o. r.
94083	M63 x 1,5	M50 x 1,5	10,0	66,0	10	o. r.	o. r.	o. r.

From PG to PG

Part no.	Size PG outside	Size PG inside	Thread length mm	Outer Ø mm	Unit	Net EUR/ 100 items at a purchase of		
						up to 100	101 - 500	501 - 1000
904410	9	7	6,0	17,0	100	o. r.	o. r.	o. r.
904411	11	7	6,0	20,0	100	o. r.	o. r.	o. r.
904412	11	9	6,0	20,0	100	o. r.	o. r.	o. r.
904413	13,5	9	6,5	22,0	100	o. r.	o. r.	o. r.
904414	16	7	6,5	24,0	50	o. r.	o. r.	o. r.
904415	16	13,5	6,5	24,0	100	o. r.	o. r.	o. r.
904416	21	13,5	7,0	30,0	50	o. r.	o. r.	o. r.
904417	21	16	7,0	30,0	50	o. r.	o. r.	o. r.
904418	29	16	8,0	39,0	25	o. r.	o. r.	o. r.
904419	29	21	8,0	39,0	25	o. r.	o. r.	o. r.
904420	42	29	10,0	57,0	10	o. r.	o. r.	o. r.

Dimensions and specifications may be changed without prior notice.

o. r. = on request

KM Counternut



KM

Counternut made of galvanic nickel-coated brass.

Material

Brass, nickel plated

Technical data

Temperature range: up to +200°C

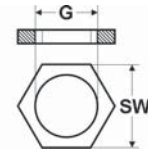

Dimensions

G Thread size inside
SW Spanner size

Metric thread - female

Part no.	Size Metr.	Spanner size mm	Unit	Net EUR/100 items at a purchase of		
				up to 100	101 - 500	501 - 1000
90175	M12 x 1,5	15,0	100	o. r.	o. r.	o. r.
90176	M16 x 1,5	19,0	100	o. r.	o. r.	o. r.
90177	M20 x 1,5	24,0	100	o. r.	o. r.	o. r.
90178	M25 x 1,5	30,0	100	o. r.	o. r.	o. r.
90179	M32 x 1,5	36,0	100	o. r.	o. r.	o. r.
90180	M40 x 1,5	46,0	50	o. r.	o. r.	o. r.
90181	M50 x 1,5	60,0	25	o. r.	o. r.	o. r.
90182	M63 x 1,5	70,0	25	o. r.	o. r.	o. r.

Metric thread - female - KM-XXL - for large cable diameters

Part no.	Size Metr.	Spanner size mm	Unit	Net EUR/100 items at a purchase of		
				up to 100	101 - 500	501 - 1000
98314	M72 x 2,0	80,0	1	o. r.	o. r.	o. r.
90067	M75 x 1,5	80,0	1	o. r.	o. r.	o. r.
90489	M80 x 2,0	95,0	1	o. r.	o. r.	o. r.

PG thread - female

Part no.	Size PG	Spanner size mm	Unit	Net EUR/100 items at a purchase of		
				up to 100	101 - 500	501 - 1000
90610	7	15,0	100	o. r.	o. r.	o. r.
90611	9	18,0	100	o. r.	o. r.	o. r.
90612	11	21,0	100	o. r.	o. r.	o. r.
90613	13,5	23,0	100	o. r.	o. r.	o. r.
90614	16	26,0	100	o. r.	o. r.	o. r.
90615	21	32,0	100	o. r.	o. r.	o. r.
90616	29	41,0	100	o. r.	o. r.	o. r.
90617	36	51,0	50	o. r.	o. r.	o. r.
90618	42	60,0	50	o. r.	o. r.	o. r.
90619	48	64,0	50	o. r.	o. r.	o. r.

NPT thread - female

Part no.	Size Inches	Spanner size mm	Unit	Net EUR/100 items at a purchase of		
				up to 100	101 - 500	501 - 1000
905870	1/2"	27,0	50	o. r.	o. r.	o. r.
905871	3/4"	32,0	50	o. r.	o. r.	o. r.
905872	1"	36,0	25	o. r.	o. r.	o. r.
905873	1 1/4"	46,0	25	o. r.	o. r.	o. r.
905874	1 1/2"	54,0	10	o. r.	o. r.	o. r.
905875	2"	70,0	10	o. r.	o. r.	o. r.

Continuation ►

KM Counternut

BSP thread - female

Part no.	Size BSP	Spanner size mm	Unit	Net EUR/100 items at a purchase of		
				up to 100	101 - 500	501 - 1000
90186	G 3/8"	19,0	100	o. r.	o. r.	o. r.
90187	G 1/2"	24,0	100	o. r.	o. r.	o. r.
90189	G 3/4"	30,0	100	o. r.	o. r.	o. r.
90190	G 1"	38,0	100	o. r.	o. r.	o. r.
90193	G 1 1/2"	51,0	50	o. r.	o. r.	o. r.
90195	G 2"	66,0	50	o. r.	o. r.	o. r.

BSP thread - female - KM-XXL - for large cable diameters

Part no.	Size BSP	Spanner size mm	Unit	Net EUR/100 items at a purchase of		
				up to 100	101 - 500	501 - 1000
90197	G 2 1/2"	80,0	1	o. r.	o. r.	o. r.
90198	G 3"	95,0	1	o. r.	o. r.	o. r.
90199	G 4"	125,0	1	o. r.	o. r.	o. r.
97785	G 5"	150,0	1	o. r.	o. r.	o. r.

Dimensions and specifications may be changed without prior notice.

o. r. = on request

VS Screw plug



VS

Screw plug made of brass.

Material

Brass, nickel plated

Technical data

Protection class: IP 54

Application

- Plant and machine construction
- Robotics
- Automation technology
- Vehicle construction and shipbuilding
- Railway technology
- Installation technology
- Control cabinet construction

Note

Screw plugs for metric threads larger than M63x1,5 available on request.

Temperature range: up to +200°C

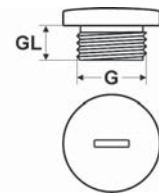

Dimensions

G Thread size

GL Thread length

Metric thread

Part no.	Size Metr.	Thread length mm	Unit	Net EUR/100 items at a purchase of		
				up to 100	101 - 500	501 - 1000
98128	M12 x 1,5	5,0	100	o. r.	o. r.	o. r.
98129	M16 x 1,5	5,0	100	o. r.	o. r.	o. r.
98130	M20 x 1,5	6,5	100	o. r.	o. r.	o. r.
98131	M25 x 1,5	7,0	100	o. r.	o. r.	o. r.
98132	M32 x 1,5	8,0	50	o. r.	o. r.	o. r.
98133	M40 x 1,5	8,5	50	o. r.	o. r.	o. r.
98134	M50 x 1,5	9,0	25	o. r.	o. r.	o. r.
98135	M63 x 1,5	10,0	10	o. r.	o. r.	o. r.

PG thread

Part no.	Size PG	Thread length mm	Unit	Net EUR/100 items at a purchase of		
				up to 100	101 - 500	501 - 1000
90620	7	5,0	100	o. r.	o. r.	o. r.
90621	9	6,0	100	o. r.	o. r.	o. r.
90622	11	6,0	100	o. r.	o. r.	o. r.
90623	13,5	6,5	100	o. r.	o. r.	o. r.
90624	16	6,5	100	o. r.	o. r.	o. r.
90625	21	7,0	50	o. r.	o. r.	o. r.
90626	29	8,0	25	o. r.	o. r.	o. r.
90627	36	9,0	50	o. r.	o. r.	o. r.
90628	42	10,0	25	o. r.	o. r.	o. r.
90629	48	10,0	25	o. r.	o. r.	o. r.

Dimensions and specifications may be changed without prior notice.

o. r. = on request

VS-O Screw plug with O-ring



VS-O

Screw plug made of brass with O-ring.

Material

Brass, nickel plated
O-ring: NBR

Technical data

Protection class: IP 68

Temperature range: -40°C up to +80°C

Application

- Plant and machine construction
- Robotics
- Automation technology
- Vehicle construction and shipbuilding
- Railway technology
- Installation technology
- Control cabinet construction

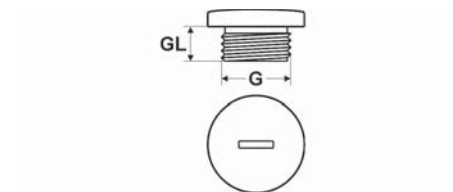

Dimensions

G Thread size
GL Thread length

Metric thread

Part no.	Size Metr.	Thread length mm	Unit	Net EUR/ 100 items at a purchase of		
				up to 100	101 - 500	501 - 1000
92600	M12 x 1,5	5,0	100	o. r.	o. r.	o. r.
92601	M16 x 1,5	5,0	100	o. r.	o. r.	o. r.
92602	M20 x 1,5	6,0	100	o. r.	o. r.	o. r.
92603	M25 x 1,5	7,0	100	o. r.	o. r.	o. r.
92604	M32 x 1,5	8,0	50	o. r.	o. r.	o. r.
92605	M40 x 1,5	8,0	50	o. r.	o. r.	o. r.
92606	M50 x 1,5	9,0	25	o. r.	o. r.	o. r.
92607	M63 x 1,5	10,0	10	o. r.	o. r.	o. r.

PG thread

Part no.	Size PG	Thread length mm	Unit	Net EUR/ 100 items at a purchase of		
				up to 100	101 - 500	501 - 1000
96763	7	5,0	100	o. r.	o. r.	o. r.
96169	9	5,0	100	o. r.	o. r.	o. r.
96889	11	5,0	100	o. r.	o. r.	o. r.
96654	13,5	6,0	100	o. r.	o. r.	o. r.
96170	16	6,0	100	o. r.	o. r.	o. r.
96171	21	6,0	100	o. r.	o. r.	o. r.
96650	29	8,0	50	o. r.	o. r.	o. r.
96649	36	9,0	25	o. r.	o. r.	o. r.

Dimensions and specifications may be changed without prior notice.

o. r. = on request

Wall sealing, dust protection, sealing inserts

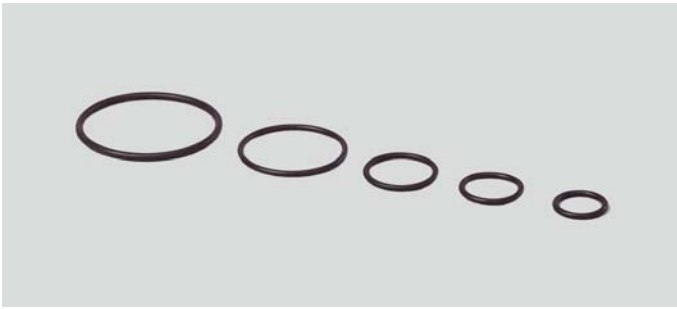

O-ring

O-rings for sealing against water, dust and oil.

refer to page 67



AGDR-PE

Threaded connection rings for sealing against water and dust.

refer to page 68



Blind plug BL-H

Blind plates as dust cap for HSK cable glands.

refer to page 69



Blind plug BL-W

Blind plates as dust cap for HSK cable glands.

refer to page 70



Incision sealing ring

Incision sealing rings for universal cable inlet through large cable clamping areas.

refer to page 71

HELUTOP HT HSK-PVDF

HELUTOP MS-EP4

KVA-XXL-MS

HELUTOP HT-Clean



■ CABLE GLANDS FOR ELECTROMAGNETIC COMPATIBILITY (EMC)

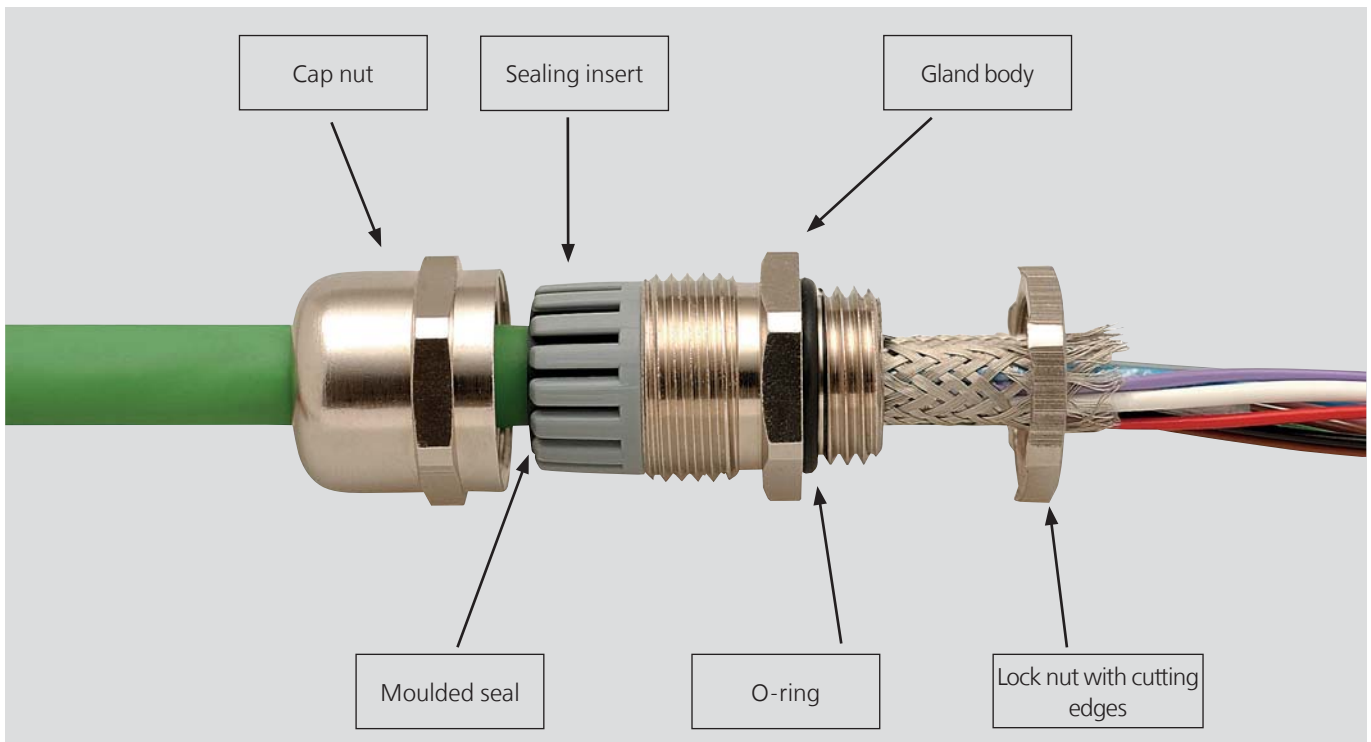

Cable gland

The cable glands are used in high-quality EMC applications. The cable glands are used in high-quality EMC applications.

Cap nut and gland body are made from nickel-plated brass.

The contact springs form a safe and reliable contact with the screened braiding of the cable. They are made from copper beryllium, which ensures good conductivity and a strong, long-lasting spring force. The spring ring is movable prior to the cap nut being tightened, which prevents damage to the screened braiding during assembly.

The terminal insert is made from polyamide 6 (PA6).

The moulded seal is made from chloroprene rubber (CR, Neoprene).

The O-ring is made from nitrile rubber (NBR, Buna-N).

Lock nut

The lock nuts are made from nickel-plated brass. They have cutting edges for cutting through coated surfaces.

Accessories

Accessories suitable for use with the brass cable glands:

- Counternuts

Accessories suitable for use with all cable glands:

- Sealing plugs
- O-rings
- Connection thread gaskets
- Blind plates

A copper tape prevents an expansion of the braid.

■ ELECTROMAGNETIC COMPATIBILITY

The subject of electromagnetic compatibility covers everything connected with intentional and unintentional malfunctions in electrical operating materials caused by electrical, magnetic or electromagnetic fields and processes.

Technically, a distinction is made between "conducted" and "non-conducted" faults:

Conducted interference are transferred directly from the source of the fault to the sink via power or signal cables.

Radiative interference is coupled with the sink by means of an electromagnetic field, i.e. as electromagnetic radiation, and is received there by a wire functioning as an antenna.

Malfunctions should not occur.

In the European EMC Directive, electromagnetic compatibility is defined as follows: The ability of a device, unit of equipment or system to function satisfactorily in its electromagnetic environment without introducing intolerable electromagnetic disturbances to any device, unit of equipment or system in that environment.

The power companies and the EU legislator require that manufacturers of electrical devices adhere to appropriate "protection requirements".

The EMC Directive is generally applied in conjunction with the Low Voltage Directive. The EMC Directive is generally applied in conjunction with the Low Voltage Directive.

Important components to avoid malfunctions

Screened cables:

The screen over the inner sheath of the cable is designed to keep out external disturbances and keep in internally-generated disturbances.

Sheet shielding or

Screened braiding – a coverage of more than 85% is considered necessary.

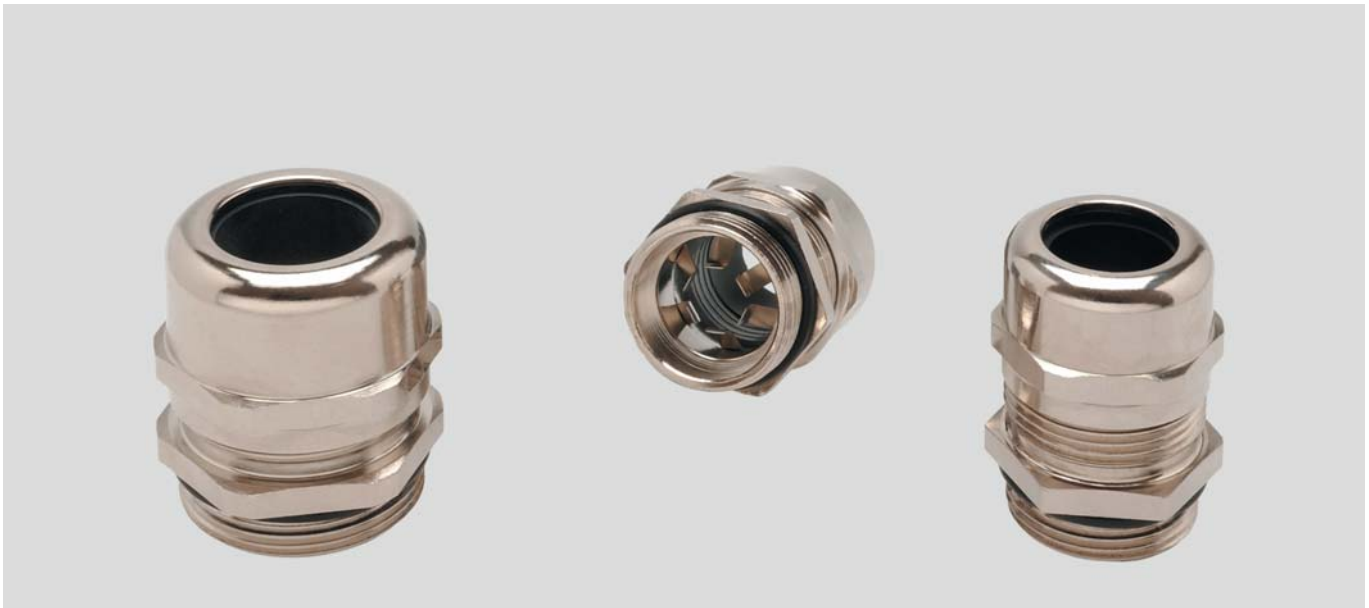

HELUTOP® MS-E

EMC cable gland with clamping fingers from spring steel for quick assembly and contacting.

Material

Brass, nickel plated
Contact system: Copper-Beryllium
Clamp: Polyamide PA 6
Seal: Chloroprene-rubber (CR)
O-ring: NBR

Note

Details on the individual tests appear in section "Technical Information".

Technical data

Protection class: IP 68 - 5 bar

Temperature range: -40°C up to +100°C

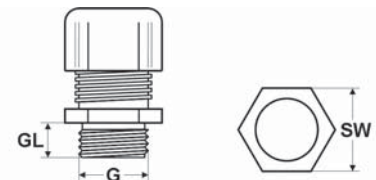

Dimensions

G Thread size
GL Thread length
SW Spanner size

PG thread

Part no.	Size PG	Cable Ø from / to mm	Thread length mm	Spanner size mm	Unit	Net EUR/ 100 items at a purchase of		
						up to 100	101 - 500	501 - 1000
90770	7	3,0 - 6,5	6,0	14	50	o. r.	o. r.	o. r.
90771	9	4,0 - 8,0	6,0	17	50	o. r.	o. r.	o. r.
90772	11	5,0 - 10,0	6,0	20	50	o. r.	o. r.	o. r.
90773	13,5	6,0 - 12,0	6,5	22	50	o. r.	o. r.	o. r.
90774	16	10,0 - 14,0	6,5	24	25	o. r.	o. r.	o. r.
90775	21	13,0 - 18,0	7,2	30	25	o. r.	o. r.	o. r.
90776	29	18,0 - 25,0	8,0	40	20	o. r.	o. r.	o. r.
90777	36	22,0 - 32,0	9,0	50	5	o. r.	o. r.	o. r.
90778	42	30,0 - 38,0	12,0	58	5	o. r.	o. r.	o. r.
90779	48	34,0 - 44,0	14,0	64	5	o. r.	o. r.	o. r.

NPT thread

Part no.	Size NPT	Cable Ø from / to mm	Thread length mm	Spanner size mm	Unit	Net EUR/ 100 items at a purchase of		
						up to 100	101 - 500	501 - 1000
99808	3/8"	5,0 - 10,0	11,5	20	50	o. r.	o. r.	o. r.
99809	1/2"	6,0 - 12,0	13,0	22	50	o. r.	o. r.	o. r.
99810	3/4"	13,0 - 18,0	13,0	30	25	o. r.	o. r.	o. r.
99811	1"	18,0 - 25,0	13,0	40	10	o. r.	o. r.	o. r.

Dimensions and specifications may be changed without prior notice.

o. r. = on request



HELUTOP® MS-EP

EMC- and earthing gland with integrated contact system for safe and quick assembly as well as contacting.

Application

- Plant and machine construction
- Robotics
- Automation technology
- Vehicle construction and shipbuilding
- Railway technology
- Installation technology
- Control cabinet construction

Material

Brass, nickel plated
 Contact system: Copper-Beryllium
 Clamp: Polyamide PA 6
 Seal: Chloroprene-rubber (CR)
 O-ring: NBR

Properties

- Optimum strain relief through clamping plates
- No damage of shield during assembly or disassembly by moving contact ring
- Contact made automatically when the gland is closed
- Excellent shield damping and current deflection
- High savings achieved in time and assembly costs

Note

Details on the individual tests appear in section "Technical Information".

Technical data

Protection class: IP 68 - 5 bar
 Temperature range: -40°C up to +100°C
 Test standard: EN50262
 Contact system: patented

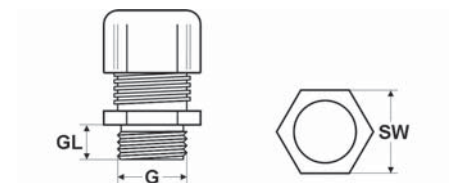

Dimensions

G Thread size
 GL Thread length
 SW Spanner size

Metric thread

Part no.	Size Metr.	Cable Ø from / to mm	Thread length mm	Spanner size mm	Unit	Net EUR/ 100 items at a purchase of		
						up to 100	101 - 500	501 - 1000
99950	M12 x 1,5	3,0 - 6,5	6,0	14	50	o. r.	o. r.	o. r.
99951	M16 x 1,5	5,0 - 10,0	7,0	20	50	o. r.	o. r.	o. r.
99952	M20 x 1,5	6,0 - 12,0	8,0	22	50	o. r.	o. r.	o. r.
99953	M25 x 1,5	11,0 - 17,0	8,0	27	25	o. r.	o. r.	o. r.
99954	M32 x 1,5	15,0 - 21,0	8,0	34	10	o. r.	o. r.	o. r.
99955	M40 x 1,5	19,0 - 28,0	9,0	43	5	o. r.	o. r.	o. r.
99956	M50 x 1,5	27,0 - 38,0	9,0	58	5	o. r.	o. r.	o. r.
99957	M63 x 1,5	34,0 - 44,0	14,0	64 / 68	5	o. r.	o. r.	o. r.

Dimensions and specifications may be changed without prior notice.

o. r. = on request

■ ELECTROMAGNETIC COMPATIBILITY

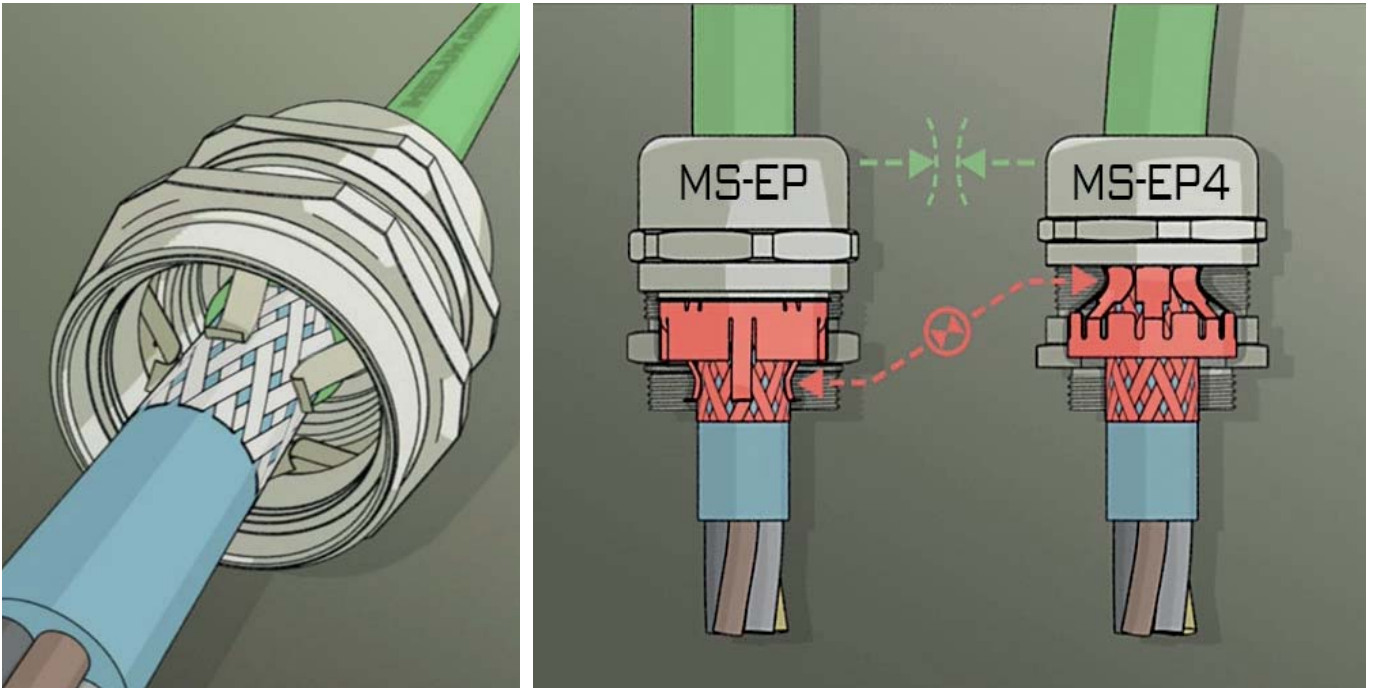

EMC glands

The screen of the cable is contacted with the housing of the control/motor via appropriate cable glands.

If the screen is applied at both ends, then one has the additional benefit of potential equalisation at both ends, and effective screening. Here it should be ensured that the two grounds are not different, otherwise a flow of disturbing equalising currents could occur.

The contact in the gland is generally created by means of a contact spring. This gives a good contact but also allows rapid assembly. Our HELUTOP® MS-EP 4 and HELUTOP® MS-EP have a simultaneously-rotating spring ring. Provided that the cable is not yet fixed, it is still possible to turn the cable in the gland. Only when it is fixed by turning the cap nut is the screen contact also finally fixed.

The particularly simple cable assembly and disassembly conditions, the gentle spring contact on the cable shield and the EMC shield's excellent resistance to vibrations are also outstanding characteristics that distinguish the new HELUTOP® MS-EP4.

Most important accessories: Lock nut with cutting edges.
Painted, anodised or contaminated surfaces are cut through by the cutting edges and the contact between the cable gland and the housing is thereby securely made.



HELUTOP® MS-EP4

EMC- cable gland with integrated contact system.

Application

- Plant and machine construction
- Robotics
- Automation technology
- Vehicle construction and shipbuilding
- Railway technology
- Installation technology
- Control cabinet construction

Material

Brass, nickel plated
 Contact system: Copper-Beryllium
 Clamp: Polyamide PA 6
 Seal: Chloroprene-rubber (CR)
 O-ring: NBR

Properties

- Easy installation
- Secure contact
- High vibration resistance

Note

Details on the individual tests appear in section "Technical Information".

Technical data

Protection class: IP 68 - 5 bar

Temperature range: -40°C up to +100°C

Contact system: patented

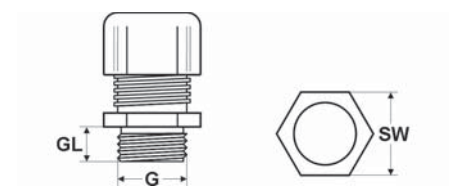

Dimensions

G Thread size
 GL Thread length
 SW Spanner size

Metric thread

Part no.	Size Metr.	Cable Ø from / to mm	Thread length mm	Spanner size mm	Unit	Net EUR/100 items at a purchase of		
						up to 100	101 - 500	501 - 1000
905181	M12 x 1,5	3,0 - 6,5	6,0	14	50	o. r.	o. r.	o. r.
905182	M16 x 1,5	5,0 - 10,0	6,0	20	50	o. r.	o. r.	o. r.
905183	M20 x 1,5	6,0 - 12,0	6,0	22	50	o. r.	o. r.	o. r.
905184	M20 x 1,5	7,5 - 14,0	8,0	24 / 26	50	o. r.	o. r.	o. r.
905185	M25 x 1,5	10,0 - 18,0	8,0	30	25	o. r.	o. r.	o. r.
905186	M32 x 1,5	16,0 - 25,0	9,0	40	10	o. r.	o. r.	o. r.
905187	M40 x 1,5	22,0 - 32,0	9,0	50	5	o. r.	o. r.	o. r.
905188	M50 x 1,5	30,0 - 38,0	9,0	58	5	o. r.	o. r.	o. r.
905189	M63 x 1,5	34,0 - 44,0	14,0	64 / 68	5	o. r.	o. r.	o. r.
905248	M63 x 1,5	37,0 - 53,0	10,0	75	5	o. r.	o. r.	o. r.

Dimensions and specifications may be changed without prior notice.

o. r. = on request

HSK-MS-E EMC cable gland

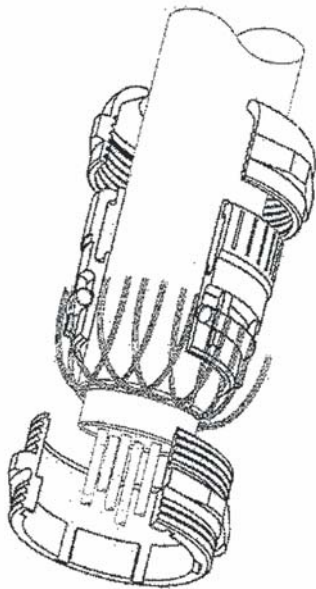

HSK-MS-E

EMC cable gland for sheathed cables.

Application

- Plant and machine construction
- Automation technology
- Vehicle construction and shipbuilding
- Installation technology

Material

Brass, nickel plated
Clamp: Polyamide PA 6
Seal: NBR
O-ring: NBR

Properties

- Easy to assemble
- Completely watertight
- Optimum strain relief
- Large clamping areas

Technical data

Protection class: IP 68 - 10 bar / IP 69K

Temperature range: -40°C up to +100°C

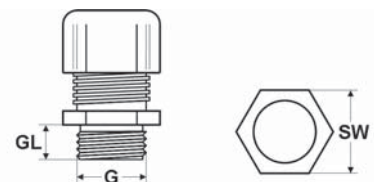

Dimensions

G Thread size
GL Thread length
SW Spanner size

Metric thread

Part no.	Size Metr.	Cable Ø from / to mm	Thread length mm	Spanner size mm	Unit	Net EUR/100 items at a purchase of		
						up to 100	101 - 500	501 - 1000
97335	M12 x 1,5	3,0 - 6,5	6,5	14	50	o. r.	o. r.	o. r.
97336	M16 x 1,5	5,0 - 10,0	6,0	20	50	o. r.	o. r.	o. r.
97337	M20 x 1,5	10,0 - 14,0	6,0	24	50	o. r.	o. r.	o. r.
97338	M25 x 1,5	13,0 - 18,0	7,0	30	25	o. r.	o. r.	o. r.
97339	M32 x 1,5	18,0 - 25,0	8,0	40	25	o. r.	o. r.	o. r.
97340	M40 x 1,5	22,0 - 32,0	8,0	50	10	o. r.	o. r.	o. r.
90397	M50 x 1,5	32,0 - 38,0	9,0	57	5	o. r.	o. r.	o. r.
90398	M63 x 1,5	37,0 - 44,0	10,0	64 / 68	5	o. r.	o. r.	o. r.

PG thread

Part no.	Size PG	Cable Ø from / to mm	Thread length mm	Spanner size mm	Unit	Net EUR/100 items at a purchase of		
						up to 100	101 - 500	501 - 1000
90423	7	3,0 - 6,5	5,0	14	50	o. r.	o. r.	o. r.
90424	9	4,0 - 8,0	6,0	17	50	o. r.	o. r.	o. r.
90425	11	5,0 - 10,0	6,0	20	50	o. r.	o. r.	o. r.
90426	13,5	6,0 - 12,0	6,5	22	50	o. r.	o. r.	o. r.
90427	16	10,0 - 14,0	6,5	24	50	o. r.	o. r.	o. r.
90428	21	13,0 - 18,0	7,0	30	25	o. r.	o. r.	o. r.
90429	29	18,0 - 25,0	8,0	40	25	o. r.	o. r.	o. r.
90430	36	22,0 - 32,0	8,0	50	10	o. r.	o. r.	o. r.
90431	42	32,0 - 38,0	9,0	57	5	o. r.	o. r.	o. r.
90432	48	37,0 - 44,0	10,0	64	5	o. r.	o. r.	o. r.

NPT thread

Part no.	Size NPT	Cable Ø from / to mm	Thread length mm	Spanner size mm	Unit	Net EUR/100 items at a purchase of		
						up to 100	101 - 500	501 - 1000
92905	3/8"	4,0 - 8,0	15,0	17 / 19	50	o. r.	o. r.	o. r.
92906	1/2"	6,0 - 12,0	13,0	22 / 24	50	o. r.	o. r.	o. r.
92907	3/4"	13,0 - 18,0	13,0	30	25	o. r.	o. r.	o. r.

Dimensions and specifications may be changed without prior notice.

o. r. = on request

HSK-MZ-E EMC - cable gland

With strain relief

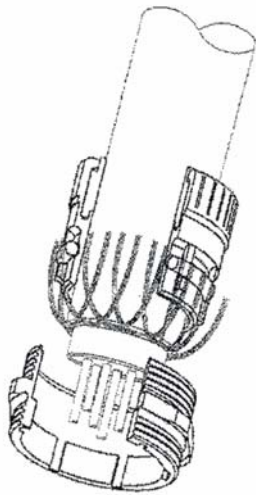

HSK-MZ-E

EMC cable gland with double bracket strain relief.

Application

- Plant and machine construction
- Automation technology
- Vehicle construction and shipbuilding
- Installation technology

Material

Brass, nickel plated
Clamp: Polyamide
Seal: NBR
O-ring: NBR

Properties

- Easy to assemble
- Completely watertight
- Optimum strain relief
- Large clamping areas

Technical data

Protection class: IP 68 - 10 bar / IP 69K
Temperature range: -40°C up to +100°C

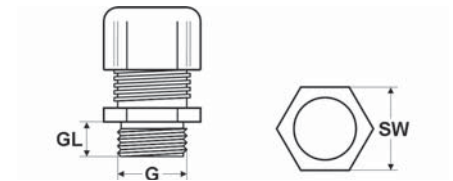

Dimensions

G Thread size
GL Thread length
SW Spanner size

Metric thread

Part no.	Size Metr.	Cable Ø from / to mm	Thread length mm	Spanner size mm	Unit	Net EUR/100 items at a purchase of		
						up to 100	101 - 500	501 - 1000
98070	M12 x 1,5	3,0 - 6,5	6,5	14	50	o. r.	o. r.	o. r.
98071	M16 x 1,5	6,0 - 10,0	6,0	20	50	o. r.	o. r.	o. r.
98072	M20 x 1,5	10,0 - 14,0	6,0	24	50	o. r.	o. r.	o. r.
98073	M25 x 1,5	13,0 - 18,0	7,0	30	25	o. r.	o. r.	o. r.
98074	M32 x 1,5	18,0 - 25,0	8,0	40	25	o. r.	o. r.	o. r.
98075	M40 x 1,5	22,0 - 32,0	8,0	50	10	o. r.	o. r.	o. r.
90162	M50 x 1,5	32,0 - 38,0	9,0	57	5	o. r.	o. r.	o. r.
90163	M63 x 1,5	37,0 - 44,0	10,0	64 / 68	5	o. r.	o. r.	o. r.

PG thread

Part no.	Size PG	Cable Ø from / to mm	Thread length mm	Spanner size mm	Unit	Net EUR/100 items at a purchase of		
						up to 100	101 - 500	501 - 1000
98061	7	3,0 - 6,5	5,0	14	50	o. r.	o. r.	o. r.
98062	9	4,0 - 8,0	6,0	17	50	o. r.	o. r.	o. r.
98063	11	6,0 - 10,0	6,0	20	50	o. r.	o. r.	o. r.
98064	13,5	6,0 - 12,0	6,5	22	50	o. r.	o. r.	o. r.
98065	16	10,0 - 14,0	6,5	24	50	o. r.	o. r.	o. r.
98201	21	13,0 - 18,0	7,0	30	25	o. r.	o. r.	o. r.
98066	29	18,0 - 25,0	8,0	40	25	o. r.	o. r.	o. r.
98067	36	22,0 - 32,0	8,0	50	10	o. r.	o. r.	o. r.
98068	42	32,0 - 38,0	9,0	57	5	o. r.	o. r.	o. r.
98069	48	37,0 - 44,0	10,0	64	5	o. r.	o. r.	o. r.

NPT thread

Part no.	Size NPT	Cable Ø from / to mm	Thread length mm	Spanner size mm	Unit	Net EUR/100 items at a purchase of		
						up to 100	101 - 500	501 - 1000
92908	3/8"	4,0 - 8,0	15,0	17 / 19	50	o. r.	o. r.	o. r.
92909	1/2"	6,0 - 12,0	13,0	22 / 24	50	o. r.	o. r.	o. r.
92910	3/4"	13,0 - 18,0	13,0	30	25	o. r.	o. r.	o. r.

Dimensions and specifications may be changed without prior notice.

o. r. = on request



HSK-MS-E-D

The EMC cable gland meets high standards in technology. Time-saving and simple handling through metallised terminal insert, which is automatically contacted when the gland is closed.

Material

Brass, nickel plated
Clamp: PA, metal-plated
Seal: NBR
O-ring: NBR

Technical data

Protection class: IP 68 - 10 bar / IP 69K
Temperature range: -40°C up to +100°C

Application

- Plant and machine construction
- Robotics
- Automation technology
- Vehicle construction and shipbuilding
- Railway technology
- Installation technology
- Control cabinet construction

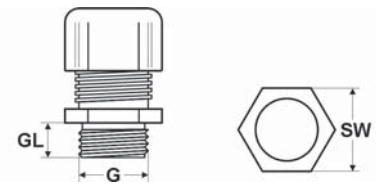

Dimensions

G Thread size
GL Thread length
SW Spanner size

Metric thread

Part no.	Size Metr.	Cable Ø from / to mm	Thread length mm	Spanner size mm	Unit	Net EUR/100 items at a purchase of		
						up to 100	101 - 500	501 - 1000
98055	M12 x 1,5	3,0 - 6,5	6,5	14	50	o. r.	o. r.	o. r.
98056	M16 x 1,5	5,0 - 10,0	6,0	20	50	o. r.	o. r.	o. r.
98057	M20 x 1,5	10,0 - 14,0	6,0	24	50	o. r.	o. r.	o. r.
98058	M25 x 1,5	13,0 - 18,0	7,0	30	25	o. r.	o. r.	o. r.
98059	M32 x 1,5	18,0 - 25,0	8,0	40	25	o. r.	o. r.	o. r.
98060	M40 x 1,5	24,0 - 32,0	8,0	50	10	o. r.	o. r.	o. r.
90160	M50 x 1,5	32,0 - 38,0	9,0	57	5	o. r.	o. r.	o. r.
90161	M63 x 1,5	37,0 - 44,0	10,0	68	5	o. r.	o. r.	o. r.

PG thread

Part no.	Size PG	Cable Ø from / to mm	Thread length mm	Spanner size mm	Unit	Net EUR/100 items at a purchase of		
						up to 100	101 - 500	501 - 1000
97655	7	3,0 - 6,5	5,0	14	50	o. r.	o. r.	o. r.
97656	9	4,0 - 8,0	6,0	17	50	o. r.	o. r.	o. r.
97657	11	5,0 - 10,0	6,0	20	50	o. r.	o. r.	o. r.
97658	13,5	6,0 - 12,0	6,5	22	50	o. r.	o. r.	o. r.
97659	16	10,0 - 14,0	6,5	24	50	o. r.	o. r.	o. r.
97660	21	13,0 - 18,0	7,0	30	25	o. r.	o. r.	o. r.
97752	29	18,0 - 25,0	8,0	40	25	o. r.	o. r.	o. r.
97788	36	24,0 - 32,0	8,0	50	10	o. r.	o. r.	o. r.

Dimensions and specifications may be changed without prior notice.

o. r. = on request

KVA-XXL-MS-E EMC cable gland



For particularly large diameters



KVA-XXL-MS-E

EMC and sealing cable gland made of brass for particularly large cable diameters.

Application

- Plant and machine construction
- Robotics
- Automation technology
- Vehicle construction and shipbuilding
- Installation technology
- Control cabinet construction

Material

Brass, nickel plated
Contact system: stainless steel 1.4310

Properties

- Large-area cable sealing
- Easy to assemble
- Large clamping range

Technical data

Protection class: IP 68 - 10 bar

Temperature range: -40°C up to +135°C

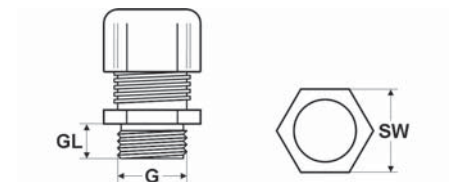

Dimensions

G Thread size
GL Thread length
SW Spanner size

Metric thread

Part no.	Size Metr.	Cable Ø from / to mm	Outer Ø Shielding from / up to mm	Thread length mm	Spanner size mm	Unit	Net EUR/ 100 items at a purchase of		
							up to 100	101 - 500	501 - 1000
98257	M63 x 1,5	40,0 - 45,0	36,0 - 41,0	10,0	65	1	o. r.	o. r.	o. r.
96560	M63 x 1,5	45,0 - 51,0	36,0 - 45,0	10,0	70	1	o. r.	o. r.	o. r.
94218	M63 x 1,5	45,0 - 51,0	40,0 - 48,0	10,0	70	1	o. r.	o. r.	o. r.
98725	M63 x 1,5	51,0 - 55,0	40,0 - 48,0	10,0	80	1	o. r.	o. r.	o. r.
94189	M72 x 2,0	40,0 - 45,0	36,0 - 41,0	15,0	70	1	o. r.	o. r.	o. r.
94847	M72 x 2,0	45,0 - 51,0	40,0 - 48,0	15,0	70	1	o. r.	o. r.	o. r.
905498	M72 x 2,0	51,0 - 55,0	40,0 - 48,5	15,0	80	1	o. r.	o. r.	o. r.
94208	M72 x 2,0	51,0 - 55,0	46,0 - 54,0	15,0	80	1	o. r.	o. r.	o. r.
94188	M72 x 2,0	54,0 - 58,0	40,0 - 48,0	15,0	80	1	o. r.	o. r.	o. r.
93728	M75 x 1,5	42,0 - 48,0	40,0 - 48,0	15,0	70	1	o. r.	o. r.	o. r.
91600	M75 x 1,5	45,0 - 51,0	40,0 - 48,0	15,0	70	1	o. r.	o. r.	o. r.
90068	M75 x 1,5	54,0 - 58,0	46,0 - 54,0	15,0	80	1	o. r.	o. r.	o. r.
97066	M80 x 2,0	58,0 - 64,0	46,0 - 54,0	15,0	95	1	o. r.	o. r.	o. r.
98908	M80 x 2,0	63,0 - 70,0	46,0 - 54,0	15,0	95	1	o. r.	o. r.	o. r.
905303	M80 x 2,0	63,0 - 70,0	46,0 - 58,0	15,0	95	1	o. r.	o. r.	o. r.

Dimensions and specifications may be changed without prior notice.

o. r. = on request



KM-EMV

- Counternut with cutting edges for secure fixing of EMC cable glands
- For cutting through painted surfaces to ensure optimum contact with equipotential bonding
- Increased vibration resistance

Material

Brass, nickel plated

Technical data

Temperature range: up to +200°C

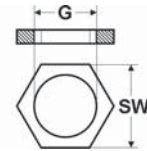

Dimensions

G Thread size inside
SW Spanner size

Metric thread - female

Part no.	Size Metr.	Spanner size mm	Unit	Net EUR/100 items at a purchase of		
				up to 100	101 - 500	501 - 1000
90165	M12 x 1,5	15,0	100	o. r.	o. r.	o. r.
90166	M16 x 1,5	19,0	100	o. r.	o. r.	o. r.
90167	M20 x 1,5	24,0	100	o. r.	o. r.	o. r.
90168	M25 x 1,5	30,0	100	o. r.	o. r.	o. r.
90169	M32 x 1,5	36,0	100	o. r.	o. r.	o. r.
90170	M40 x 1,5	46,0	50	o. r.	o. r.	o. r.
90171	M50 x 1,5	60,0	50	o. r.	o. r.	o. r.
90172	M63 x 1,5	70,0	25	o. r.	o. r.	o. r.

Metric thread - female - KM-EMV-XXL - for large cable diameters

Part no.	Size Metr.	Spanner size mm	Unit	Net EUR/100 items at a purchase of		
				up to 100	101 - 500	501 - 1000
99875	M72 x 2,0	80,0	1	o. r.	o. r.	o. r.
93209	M75 x 1,5	80,0	1	o. r.	o. r.	o. r.
98698	M80 x 2,0	95,0	1	o. r.	o. r.	o. r.

PG thread - female

Part no.	Size PG	Spanner size mm	Unit	Net EUR/100 items at a purchase of		
				up to 100	101 - 500	501 - 1000
97243	7	15,0	100	o. r.	o. r.	o. r.
97244	9	18,0	100	o. r.	o. r.	o. r.
97166	11	21,0	100	o. r.	o. r.	o. r.
97167	13,5	23,0	100	o. r.	o. r.	o. r.
97168	16	26,0	100	o. r.	o. r.	o. r.
97169	21	32,0	100	o. r.	o. r.	o. r.
97170	29	41,0	50	o. r.	o. r.	o. r.
97171	36	51,0	25	o. r.	o. r.	o. r.
97245	42	60,0	25	o. r.	o. r.	o. r.
97246	48	64,0	25	o. r.	o. r.	o. r.

Dimensions and specifications may be changed without prior notice.

o. r. = on request

Electricians scissors For screened cables and wires



Electricians scissors

- Cuts copper braid shielded cables and wires
- Clean cut with serrated edge
- With round wire cutter
- Very stable version
- Cut from special stainless steel, nickel plated
- Handy
- Length 125 mm
- Weight 65 g

Electricians scissors

Part no.	Type	Unit	Net EUR/item at a purchase of		
			1	2 - 4	5 - 10
905120	Electricians scissors	1	o. r.	o. r.	o. r.

Dimensions and specifications may be changed without prior notice.

o. r. = on request

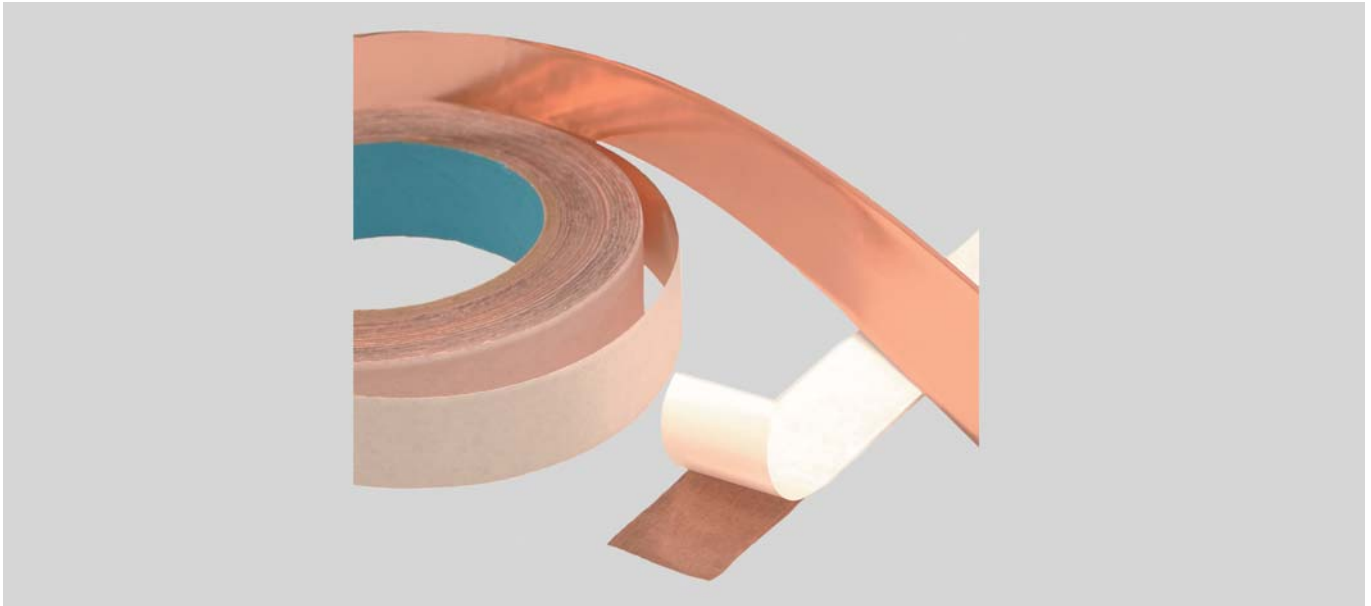

Copper tape

Stabilizes the braided ends of shielded cables and wires.

Material

Rolled copper foil

Properties

- Self-adhesive
- With protective cover for the adhesive
- Electrically conductive adhesive
- Adhesive strength 900g/inch (according to KS A 1107)
- Thickness approx 40µm
- Thickness incl. adhesive approx 70µm

Note

Other dimensions on request.

Part no.	Width mm	Length m	Unit	Net EUR/item at a purchase of		
				1	2 - 5	6 - 10
905122	10	33	1	o. r.	o. r.	o. r.
905116	15	33	1	o. r.	o. r.	o. r.
905117	20	33	1	o. r.	o. r.	o. r.
905118	25	33	1	o. r.	o. r.	o. r.
905119	50	33	1	o. r.	o. r.	o. r.

Dimensions and specifications may be changed without prior notice.

o. r. = on request

HELUTOP HT

HSK-PVDF

HELUTOP MS-EP4

KVA-XXL-MS

HELUTOP HT-Clean



■ STAINLESS STEEL CABLE GLANDS

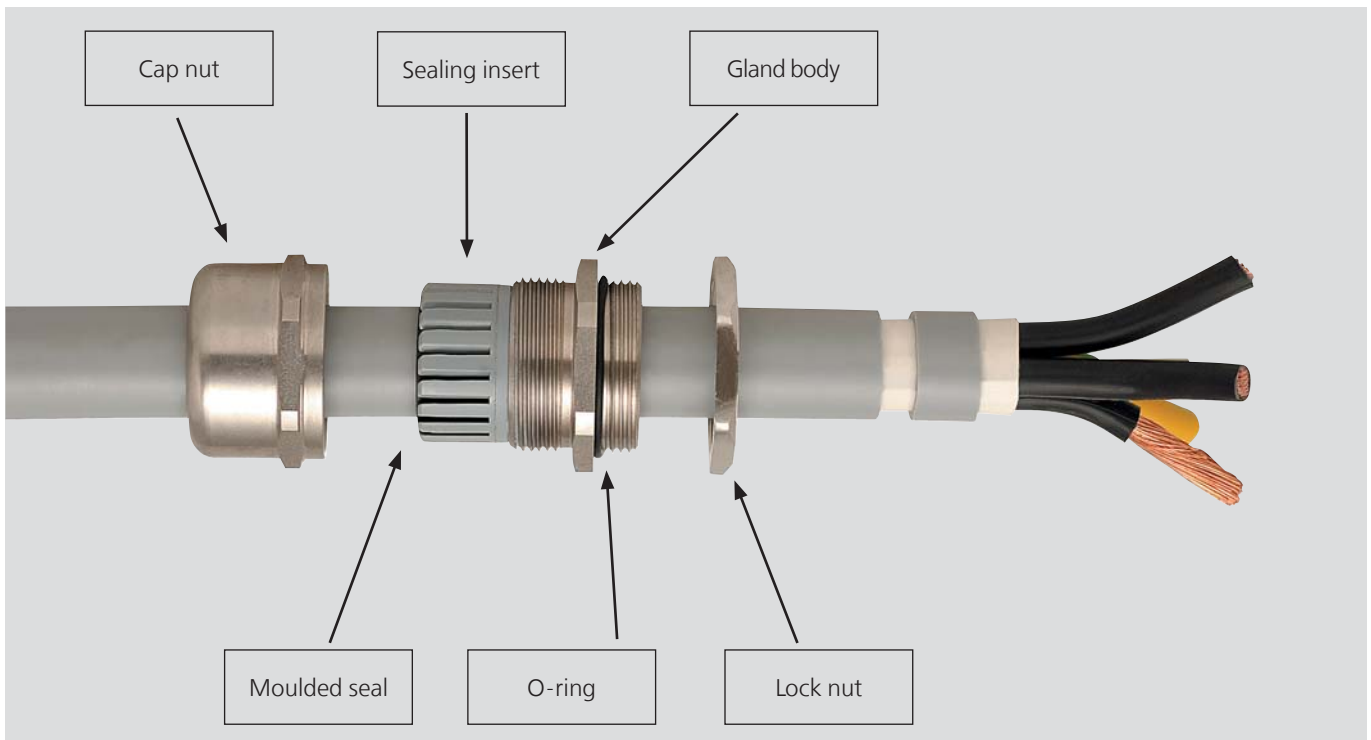

Cable gland

Cap nut and gland body are made of stainless steel. Due to their high degree of corrosion resistance and longevity, these glands are suitable for tough conditions:

- Heavy chemical loads
- Cleaning agents (e.g. in the food industry)
- Weather-resistant when used outdoors.

The terminal insert is made from polyamide 6 (PA6).

The moulded seal is made from chloroprene rubber (CR, Neoprene).

The O-ring is made from nitrile rubber (NBR, Buna-N).

Lock nut

The lock nuts are made from stainless steel.

Accessories

Accessories suitable for use with the stainless steel cable glands:

- Lock nuts

Accessories suitable for use with all cable glands:

- Sealing plugs
- Multiple sealing inserts / lock bolts
- O-rings
- Connection thread gaskets
- Blind plates

HELUTOP® HT-E Cable gland



Stainless steel



HELUTOP® HT-E

Stainless steel cable gland for heavy load.

Application

- Plant and machine construction
- Robotics
- Automation technology
- Vehicle construction and shipbuilding
- Railway technology
- Installation technology
- Control cabinet construction

Material

Stainless steel 1.4305 / AISI 303
Clamp: Polyamide PA 6
Seal: Chloroprene-rubber (CR)
O-ring: NBR

Properties

- Optimum strain relief through clamping plates
- Highly corrosion-resistant
- Highly durable
- Easy to assemble
- Large clamping areas

Note

Details on the individual tests appear in section "Technical Information".

Technical data

Protection class: IP 68 - 5 bar

Temperature range: -40°C up to +100°C

Test standard: EN50262

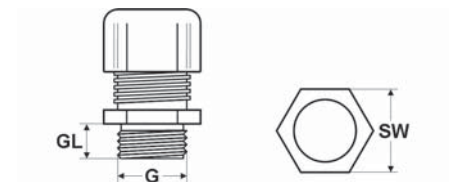

Dimensions

G Thread size
GL Thread length
SW Spanner size

Metric thread

Part no.	Size Metr.	Cable Ø from / to mm	Thread length mm	Spanner size mm	Unit	Net EUR/100 items at a purchase of		
						up to 100	101 - 500	501 - 1000
99980	M12 x 1,5	3,0 - 6,5	6,0	14	50	o. r.	o. r.	o. r.
99981	M16 x 1,5	5,0 - 10,0	7,0	22	50	o. r.	o. r.	o. r.
99982	M20 x 1,5	6,0 - 12,0	8,0	22	50	o. r.	o. r.	o. r.
99983	M25 x 1,5	11,0 - 17,0	8,0	27	25	o. r.	o. r.	o. r.
99984	M32 x 1,5	15,0 - 21,0	8,0	36	25	o. r.	o. r.	o. r.
99985	M40 x 1,5	19,0 - 28,0	9,0	46	20	o. r.	o. r.	o. r.
99986	M50 x 1,5	30,0 - 38,0	9,0	60	12	o. r.	o. r.	o. r.
99987	M63 x 1,5	34,0 - 44,0	14,0	65 / 68	12	o. r.	o. r.	o. r.

PG thread

Part no.	Size PG	Cable Ø from / to mm	Thread length mm	Spanner size mm	Unit	Net EUR/100 items at a purchase of		
						up to 100	101 - 500	501 - 1000
99970	7	3,0 - 6,5	6,0	14	50	o. r.	o. r.	o. r.
99971	9	4,0 - 8,0	6,0	17	50	o. r.	o. r.	o. r.
99972	11	5,0 - 10,0	6,0	22	50	o. r.	o. r.	o. r.
99973	13,5	6,0 - 12,0	6,5	22	50	o. r.	o. r.	o. r.
99974	16	10,0 - 14,0	6,5	24	25	o. r.	o. r.	o. r.
99975	21	13,0 - 18,0	7,2	30	25	o. r.	o. r.	o. r.
99976	29	18,0 - 25,0	8,0	41	20	o. r.	o. r.	o. r.
99977	36	22,0 - 32,0	9,0	50	15	o. r.	o. r.	o. r.
99978	42	30,0 - 38,0	12,0	60	12	o. r.	o. r.	o. r.
99979	48	34,0 - 44,0	14,0	65	12	o. r.	o. r.	o. r.

NPT thread

Part no.	Size NPT	Cable Ø from / to mm	Thread length mm	Spanner size mm	Unit	Net EUR/100 items at a purchase of		
						up to 100	101 - 500	501 - 1000
99800	3/8"	5,0 - 10,0	11,5	20	50	o. r.	o. r.	o. r.
99801	1/2"	6,0 - 12,0	13,0	22	50	o. r.	o. r.	o. r.
99802	3/4"	13,0 - 18,0	13,0	30	25	o. r.	o. r.	o. r.
99803	1"	18,0 - 25,0	13,0	40 / 43	10	o. r.	o. r.	o. r.

Dimensions and specifications may be changed without prior notice.

o. r. = on request

HSK-PVDF Cable gland

Polyvinylidene fluoride



HSK-PVDF

Polyvinylidene fluoride for use in the chemical industry, at high temperatures, under long-term UV exposure.
The cable gland to meet stringent requirements in technology.

Material

PVDF
Clamp: PVDF
Seal: FKM

- phosphor-free
- silicone-free
- cadmium-free

Properties

- Easy to assemble
- Completely water-tight
- Optimum strain relief
- Large clamping areas

Technical data

Protection class: IP 68 - 10 bar / IP 69K (within the specific clamping range with additional o-ring)

Temperature range: -35°C up to +150°C

Test standard: EN50262

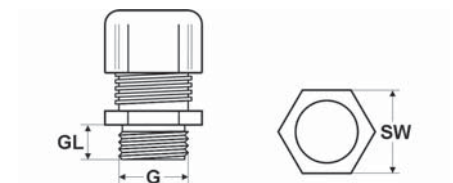

Dimensions

G Thread size
GL Thread length
SW Spanner size

Metric thread

Part no. natural	Size Metr.	Cable Ø from / to mm	Thread length mm	Spanner size mm	Unit	Net EUR/ 100 items at a purchase of		
						up to 100	101 - 500	501 - 1000
97527	M12 x 1,5	3,0 - 6,5	8,0	15	50	o. r.	o. r.	o. r.
97528	M16 x 1,5	4,0 - 8,0	8,0	19	50	o. r.	o. r.	o. r.
97529	M20 x 1,5	6,0 - 12,0	9,0	24	50	o. r.	o. r.	o. r.
97530	M25 x 1,5	13,0 - 18,0	11,0	33	50	o. r.	o. r.	o. r.
97531	M32 x 1,5	18,0 - 25,0	11,0	42	25	o. r.	o. r.	o. r.

Metric thread - with reducing seal

Part no. natural	Size Metr.	Cable Ø from / to mm	Thread length mm	Spanner size mm	Unit	Net EUR/ 100 items at a purchase of		
						up to 100	101 - 500	501 - 1000
99630	M12 x 1,5	2,0 - 5,0	8,0	15	50	o. r.	o. r.	o. r.
99631	M16 x 1,5	2,0 - 6,0	8,0	19	50	o. r.	o. r.	o. r.
99632	M20 x 1,5	5,0 - 9,0	9,0	24	50	o. r.	o. r.	o. r.
99633	M25 x 1,5	9,0 - 16,0	11,0	33	50	o. r.	o. r.	o. r.
99634	M32 x 1,5	13,0 - 20,0	11,0	42	25	o. r.	o. r.	o. r.

Continuation ►

HSK-PVDF Cable gland



Polyvinylidene fluoride

PG thread

Part no. natural	Size PG	Cable Ø from / to mm	Thread length mm	Spanner size mm	Unit	Net EUR/ 100 items at a purchase of		
						up to 100	101 - 500	501 - 1000
97184	7	3,0 - 6,5	8,0	15	50	o. r.	o. r.	o. r.
96748	9	4,0 - 8,0	8,0	19	50	o. r.	o. r.	o. r.
97185	11	5,0 - 10,0	8,0	22	50	o. r.	o. r.	o. r.
97186	13,5	6,0 - 12,0	9,0	24	50	o. r.	o. r.	o. r.
97187	16	10,0 - 14,0	10,0	27	50	o. r.	o. r.	o. r.
97188	21	13,0 - 18,0	11,0	33	50	o. r.	o. r.	o. r.
97189	29	18,0 - 25,0	11,0	42	25	o. r.	o. r.	o. r.
97190	36	22,0 - 32,0	13,0	53	10	o. r.	o. r.	o. r.
97191	42	32,0 - 38,0	13,0	60	5	o. r.	o. r.	o. r.
97192	48	37,0 - 44,0	14,0	65	5	o. r.	o. r.	o. r.

NPT thread

Part no. natural	Size NPT	Cable Ø from / to mm	Thread length mm	Spanner size mm	Unit	Net EUR/ 100 items at a purchase of		
						up to 100	101 - 500	501 - 1000
91675	3/8"	4,0 - 8,0	15,0	19 / 22	50	o. r.	o. r.	o. r.
91676	1/2"	6,0 - 12,0	13,0	24	50	o. r.	o. r.	o. r.
91677	1/2"	10,0 - 14,0	13,0	27	50	o. r.	o. r.	o. r.
91678	3/4"	13,0 - 18,0	14,0	33	50	o. r.	o. r.	o. r.

Dimensions and specifications may be changed without prior notice.

o. r. = on request

HSK-MS-PVDF Cable gland

Brass and polyvinylidene fluoride



HSK-MS-PVDF

Cable gland to meet stringent requirements in technology.

Polyvinylidene fluoride for use in the chemical industry, at high temperatures, under long-term UV exposure.

Material

Brass, nickel plated
Clamp: PVDF
Seal: FKM
O-ring: FKM

Properties

- Easy to assemble
- Completely water-tight
- Optimum strain relief
- Large clamping areas

Technical data

Protection class: IP 68 - 10 bar / IP 69K
Temperature range: -35°C up to +150°C

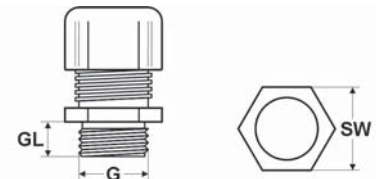

Dimensions

G Thread size
GL Thread length
SW Spanner size

Metric thread

Part no.	Size Metr.	Cable Ø from / to mm	Thread length mm	Spanner size mm	Unit	Net EUR/100 items at a purchase of		
						up to 100	101 - 500	501 - 1000
97571	M12 x 1,5	3,0 - 6,5	6,5	14	50	o. r.	o. r.	o. r.
97572	M16 x 1,5	4,0 - 8,0	6,0	17 / 19	50	o. r.	o. r.	o. r.
905084	M16 x 1,5	5,0 - 10,0	6,0	20	50	o. r.	o. r.	o. r.
97573	M20 x 1,5	10,0 - 14,0	6,0	24	50	o. r.	o. r.	o. r.
97574	M25 x 1,5	13,0 - 18,0	7,0	30	25	o. r.	o. r.	o. r.
97575	M32 x 1,5	18,0 - 25,0	8,0	40	25	o. r.	o. r.	o. r.
97576	M40 x 1,5	22,0 - 32,0	8,0	50	10	o. r.	o. r.	o. r.

PG thread

Part no.	Size PG	Cable Ø from / to mm	Thread length mm	Spanner size mm	Unit	Net EUR/100 items at a purchase of		
						up to 100	101 - 500	501 - 1000
97565	7	3,0 - 6,5	5,0	14	50	o. r.	o. r.	o. r.
97500	9	4,0 - 8,0	6,0	17	50	o. r.	o. r.	o. r.
97445	11	5,0 - 10,0	6,0	20	50	o. r.	o. r.	o. r.
97446	13,5	6,0 - 12,0	6,5	22	50	o. r.	o. r.	o. r.
97447	16	10,0 - 14,0	6,5	24	50	o. r.	o. r.	o. r.
97566	21	13,0 - 18,0	7,0	30	25	o. r.	o. r.	o. r.
97567	29	18,0 - 25,0	8,0	40	25	o. r.	o. r.	o. r.
97568	36	22,0 - 32,0	8,0	50	10	o. r.	o. r.	o. r.
97569	42	32,0 - 38,0	9,0	57	5	o. r.	o. r.	o. r.
97570	48	37,0 - 44,0	10,0	64	5	o. r.	o. r.	o. r.

NPT thread

Part no.	Size NPT	Cable Ø from / to mm	Thread length mm	Spanner size mm	Unit	Net EUR/100 items at a purchase of		
						up to 100	101 - 500	501 - 1000
97663	3/8"	4,0 - 8,0	15,0	17 / 19	25	o. r.	o. r.	o. r.
97664	1/2"	6,0 - 12,0	13,0	22 / 24	50	o. r.	o. r.	o. r.

Dimensions and specifications may be changed without prior notice.

o. r. = on request



HSK-INOX

Stainless steel cable gland

Application

- Plant and machine construction
- Automation technology
- Installation technology

Material

Stainless steel 1.4305 / AISI 303
 Clamp: Polyamide
 Seal: NBR
 O-ring: NBR

Properties

- Easy to assemble
- Completely water-tight
- Optimum strain relief
- Large clamping areas

Technical data

Protection class: IP 68 - 10 bar / IP 69K
 Temperature range: -40°C up to +100°C

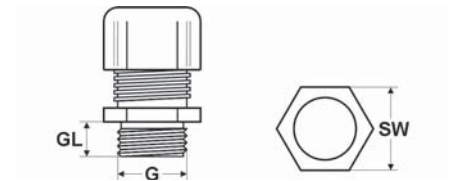

Dimensions

G Thread size
 GL Thread length
 SW Spanner size

Metric thread

Part no.	Size Metr.	Cable Ø from / to mm	Thread length mm	Spanner size mm	Unit	Net EUR/ 100 items at a purchase of		
						up to 100	101 - 500	501 - 1000
98076	M12 x 1,5	3,0 - 6,5	6,5	14	10	o. r.	o. r.	o. r.
98078	M16 x 1,5	5,0 - 10,0	6,0	22	10	o. r.	o. r.	o. r.
98080	M20 x 1,5	10,0 - 14,0	6,0	24	10	o. r.	o. r.	o. r.
98082	M25 x 1,5	13,0 - 18,0	7,0	30	10	o. r.	o. r.	o. r.
98084	M32 x 1,5	18,0 - 25,0	8,0	41	5	o. r.	o. r.	o. r.
98086	M40 x 1,5	22,0 - 32,0	8,0	50	5	o. r.	o. r.	o. r.
905734	M50 x 1,5	32,0 - 38,0	9,0	60	5	o. r.	o. r.	o. r.
905736	M63 x 1,5	37,0 - 44,0	10,0	64 / 68	5	o. r.	o. r.	o. r.

Metric thread - with reducing seal

Part no.	Size Metr.	Cable Ø from / to mm	Thread length mm	Spanner size mm	Unit	Net EUR/ 100 items at a purchase of		
						up to 100	101 - 500	501 - 1000
98077	M12 x 1,5	2,0 - 5,0	6,5	14	10	o. r.	o. r.	o. r.
98079	M16 x 1,5	3,0 - 7,0	6,0	22	10	o. r.	o. r.	o. r.
98081	M20 x 1,5	7,0 - 12,0	6,0	24	10	o. r.	o. r.	o. r.
98083	M25 x 1,5	9,0 - 16,0	7,0	30	10	o. r.	o. r.	o. r.
98085	M32 x 1,5	13,0 - 20,0	8,0	41	5	o. r.	o. r.	o. r.
98087	M40 x 1,5	20,0 - 26,0	8,0	50	5	o. r.	o. r.	o. r.
905733	M50 x 1,5	25,0 - 31,0	9,0	60	5	o. r.	o. r.	o. r.
905735	M63 x 1,5	29,0 - 35,0	10,0	64 / 68	5	o. r.	o. r.	o. r.

Continuation ►

Stainless steel

PG thread

Part no.	Size PG	Cable Ø from / to mm	Thread length mm	Spanner size mm	Unit	Net EUR/100 items at a purchase of		
						up to 100	101 - 500	501 - 1000
90210	7	3,0 - 6,5	5,0	14	10	o. r.	o. r.	o. r.
90212	9	4,0 - 8,0	6,0	17	10	o. r.	o. r.	o. r.
90214	11	5,0 - 10,0	6,0	22	10	o. r.	o. r.	o. r.
90216	13,5	6,0 - 12,0	6,5	22	10	o. r.	o. r.	o. r.
90218	16	10,0 - 14,0	6,5	24	10	o. r.	o. r.	o. r.
90377	21	13,0 - 18,0	7,0	30	10	o. r.	o. r.	o. r.
98286	29	18,0 - 25,0	8,0	41	5	o. r.	o. r.	o. r.
98288	36	22,0 - 32,0	8,0	50	5	o. r.	o. r.	o. r.
905738	42	32,0 - 38,0	9,0	57	5	o. r.	o. r.	o. r.
905740	48	37,0 - 44,0	10,0	64	5	o. r.	o. r.	o. r.

PG thread - with reducing seal

Part no.	Size PG	Cable Ø from / to mm	Thread length mm	Spanner size mm	Unit	Net EUR/100 items at a purchase of		
						up to 100	101 - 500	501 - 1000
90211	7	2,0 - 5,0	5,0	14	10	o. r.	o. r.	o. r.
90213	9	2,0 - 6,0	6,0	17	10	o. r.	o. r.	o. r.
90215	11	3,0 - 7,0	6,0	22	10	o. r.	o. r.	o. r.
90217	13,5	5,0 - 9,0	6,5	22	10	o. r.	o. r.	o. r.
90219	16	7,0 - 12,0	6,5	24	10	o. r.	o. r.	o. r.
90378	21	9,0 - 16,0	7,0	30	10	o. r.	o. r.	o. r.
98287	29	13,0 - 20,0	8,0	41	5	o. r.	o. r.	o. r.
98289	36	20,0 - 26,0	8,0	50	5	o. r.	o. r.	o. r.
905737	42	25,0 - 31,0	9,0	57	5	o. r.	o. r.	o. r.
905739	48	29,0 - 35,0	10,0	64	5	o. r.	o. r.	o. r.

NPT thread

Part no.	Size NPT	Cable Ø from / to mm	Thread length mm	Spanner size mm	Unit	Net EUR/100 items at a purchase of		
						up to 100	101 - 500	501 - 1000
905742	3/8"	4,0 - 8,0	15,0	17 / 19	5	o. r.	o. r.	o. r.
905744	1/2"	6,0 - 12,0	13,0	22 / 24	10	o. r.	o. r.	o. r.
905746	3/4"	13,0 - 18,0	13,0	30	5	o. r.	o. r.	o. r.
905748	1"	18,0 - 25,0	19,0	41	10	o. r.	o. r.	o. r.

NPT thread - with reducing seal

Part no.	Size NPT	Cable Ø from / to mm	Thread length mm	Spanner size mm	Unit	Net EUR/100 items at a purchase of		
						up to 100	101 - 500	501 - 1000
905741	3/8"	2,0 - 6,0	15,0	17 / 19	5	o. r.	o. r.	o. r.
905743	1/2"	5,0 - 9,0	13,0	22 / 24	5	o. r.	o. r.	o. r.
905745	3/4"	9,0 - 16,0	13,0	30	5	o. r.	o. r.	o. r.
905747	1"	13,0 - 20,0	19,0	41	10	o. r.	o. r.	o. r.

Dimensions and specifications may be changed without prior notice.

o. r. = on request

UNI-DICHT-VK-PVDF Body gland

Polyvinylidene fluoride



UNI-DICHT-VK-PVDF

Gland body made of PVDF for populating with inserts made of TPE or silicone. For use in chemical industry, at high temperatures, or long lasting UV-stress.

Application

- Chemical industry
- Food industry
- Plant and machine construction
- Automation technology
- Installation technology
- Control cabinet construction

Material

PVDF

- phosphor-free
- cadmium-free

Note

Use short-sized inserts when using gland bodies of size M12x1.5 or M20x1.5.

Technical data

Temperature range: -40°C up to +150°C

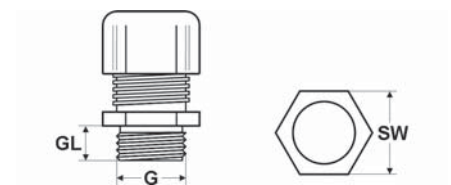

Dimensions

- G Thread size
- GL Thread length
- SW Spanner size

Metric thread

Part no.	Size Metr.	Thread length mm	Spanner size mm	Unit	Net EUR/ 100 items at a purchase of		
					up to 100	101 - 500	501 - 1000
904240	M12 x 1,5	8,0	15	50	o. r.	o. r.	o. r.
904241	M16 x 1,5	9,0	19	50	o. r.	o. r.	o. r.
904242	M20 x 1,5	9,0	24	50	o. r.	o. r.	o. r.
904243	M25 x 1,5	9,0	29	50	o. r.	o. r.	o. r.
904244	M32 x 1,5	11,0	38	25	o. r.	o. r.	o. r.
904245	M40 x 1,5	11,5	46	10	o. r.	o. r.	o. r.
904246	M50 x 1,5	13,0	56	5	o. r.	o. r.	o. r.

Dimensions and specifications may be changed without prior notice.

o. r. = on request

UNI-DICHT-VK-stainless steel Body gland

Stainless steel



UNI-DICHT-VK-stainless steel

Gland body made of stainless steel for populating with inserts made of TPE. For use in chemical industry, at high temperatures, or long lasting UV-stress.

Application

- Chemical industry
- Food industry
- Plant and machine construction
- Automation technology
- Installation technology
- Control cabinet construction

Material

Stainless steel 1.4305 / AISI 303

Technical data

Temperature range: up to +200°C

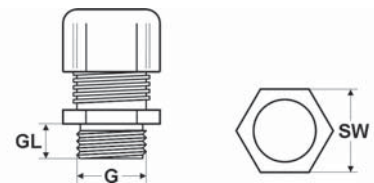

Dimensions

G Thread size
GL Thread length
SW Spanner size

Metric thread

Part no.	Size Metr.	Thread length mm	Spanner size mm	Unit	Net EUR/100 items at a purchase of		
					up to 100	101 - 500	501 - 1000
904247	M12 x 1,5	5,0	14	50	o. r.	o. r.	o. r.
904248	M16 x 1,5	6,0	19	50	o. r.	o. r.	o. r.
904249	M20 x 1,5	6,5	22	50	o. r.	o. r.	o. r.
904250	M25 x 1,5	7,5	27	50	o. r.	o. r.	o. r.
904251	M32 x 1,5	8,0	36	25	o. r.	o. r.	o. r.
904252	M40 x 1,5	8,0	46	10	o. r.	o. r.	o. r.
904253	M50 x 1,5	10,0	55	5	o. r.	o. r.	o. r.

Dimensions and specifications may be changed without prior notice.

o. r. = on request

UNI-DICHT Sealing insert

Standard, silicone

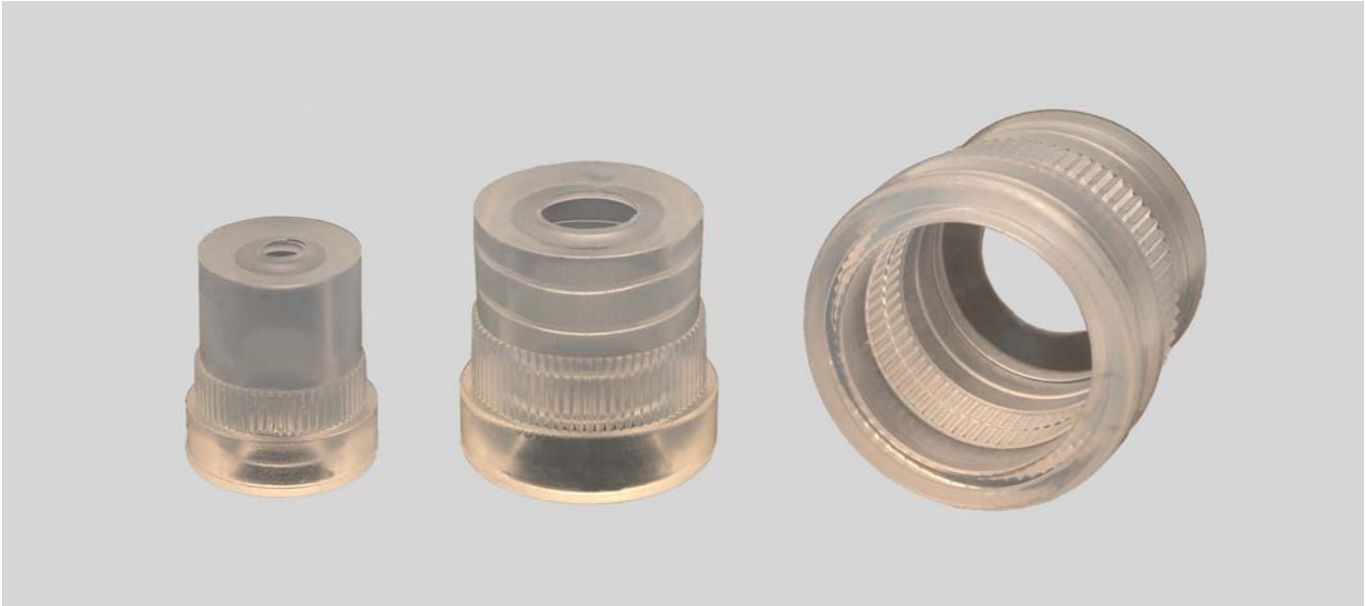

UNI-DICHT sealing insert silicone

Sealing inserts made of silicone for populating of UNI-DICHT gland bodies. For use in chemical industry and at high temperatures.

Application

- Plant and machine construction
- Robotics
- Automation technology
- Vehicle construction and shipbuilding
- Railway technology
- Installation technology
- Control cabinet construction

Material

Silicone

- halogen-free
- phosphor-free
- cadmium-free

Note

Short-size inserts are used with gland bodies made of PVDF.

Standard size inserts are used with gland bodies made of stainless steel.

Technical data

Temperature range: -60°C up to +200°C

Part no.	Size metric	Sealing insert colour	Cable Ø from / to mm	Unit	Net EUR/100 items at a purchase of		
					up to 100	101 - 500	501 - 1000
904254	M12 x 1,5	transparent/short	4,0 - 6,5	100	o. r.	o. r.	o. r.
904255	M12 x 1,5	transparent	4,0 - 6,5	100	o. r.	o. r.	o. r.
904256	M16 x 1,5	transparent	4,0 - 6,5	100	o. r.	o. r.	o. r.
904257	M16 x 1,5	transparent	6,5 - 9,5	100	o. r.	o. r.	o. r.
904258	M20 x 1,5	transparent/short	4,0 - 6,5	100	o. r.	o. r.	o. r.
904259	M20 x 1,5	transparent	4,0 - 6,5	100	o. r.	o. r.	o. r.
904260	M20 x 1,5	transparent/short	6,5 - 9,5	100	o. r.	o. r.	o. r.
904261	M20 x 1,5	transparent	6,5 - 9,5	100	o. r.	o. r.	o. r.
904262	M20 x 1,5	transparent/short	7,0 - 10,5	100	o. r.	o. r.	o. r.
904263	M20 x 1,5	transparent	7,0 - 10,5	100	o. r.	o. r.	o. r.
904264	M20 x 1,5	transparent	9,0 - 13,0	100	o. r.	o. r.	o. r.
904265	M25 x 1,5	transparent	7,0 - 10,5	100	o. r.	o. r.	o. r.
904266	M25 x 1,5	transparent	9,0 - 13,0	100	o. r.	o. r.	o. r.
904267	M25 x 1,5	transparent	11,5 - 15,5	100	o. r.	o. r.	o. r.
904268	M32 x 1,5	transparent	9,0 - 13,0	50	o. r.	o. r.	o. r.
904269	M32 x 1,5	transparent	11,5 - 15,5	50	o. r.	o. r.	o. r.
904270	M32 x 1,5	transparent	14,0 - 18,0	50	o. r.	o. r.	o. r.
904271	M40 x 1,5	transparent	14,0 - 18,0	25	o. r.	o. r.	o. r.
904272	M40 x 1,5	transparent	17,0 - 20,5	25	o. r.	o. r.	o. r.
904273	M40 x 1,5	transparent	20,0 - 25,0	25	o. r.	o. r.	o. r.
904274	M40 x 1,5	transparent	24,0 - 28,0	25	o. r.	o. r.	o. r.
904275	M50 x 1,5	transparent	27,0 - 32,0	10	o. r.	o. r.	o. r.
904276	M50 x 1,5	transparent	29,0 - 34,0	10	o. r.	o. r.	o. r.
904277	M50 x 1,5	transparent	32,0 - 36,0	10	o. r.	o. r.	o. r.

Dimensions and specifications may be changed without prior notice.

o. r. = on request

KM-INOX Counternut

Stainless steel



KM-INOX

Counternut made of stainless steel.

Material

Stainless steel 1.4305 / AISI 303

Technical data

Temperature range: up to +200°C

Application

- Plant and machine construction
- Robotics
- Automation technology
- Vehicle construction and shipbuilding
- Railway technology
- Installation technology
- Control cabinet construction

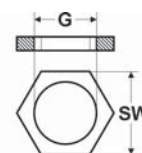

Dimensions

G Thread size inside
SW Spanner size

Metric thread - female

Part no.	Size Metr.	Spanner size mm	Unit	Net EUR/100 items at a purchase of		
				up to 100	101 - 500	501 - 1000
920605	M12 x 1,5	15,0	100	o. r.	o. r.	o. r.
920606	M16 x 1,5	19,0	100	o. r.	o. r.	o. r.
920607	M20 x 1,5	24,0	100	o. r.	o. r.	o. r.
920608	M25 x 1,5	30,0	100	o. r.	o. r.	o. r.
920609	M32 x 1,5	36,0	50	o. r.	o. r.	o. r.
920610	M40 x 1,5	46,0	50	o. r.	o. r.	o. r.
920611	M50 x 1,5	60,0	10	o. r.	o. r.	o. r.
920612	M63 x 1,5	70,0	10	o. r.	o. r.	o. r.

PG thread - female

Part no.	Size PG	Spanner size mm	Unit	Net EUR/100 items at a purchase of		
				up to 100	101 - 500	501 - 1000
92970	7	17,0	100	o. r.	o. r.	o. r.
92971	9	19,0	100	o. r.	o. r.	o. r.
92972	11	22,0	100	o. r.	o. r.	o. r.
92973	13,5	24,0	100	o. r.	o. r.	o. r.
92974	16	27,0	100	o. r.	o. r.	o. r.
92975	21	32,0	100	o. r.	o. r.	o. r.
92976	29	41,0	50	o. r.	o. r.	o. r.
92977	36	60,0	25	o. r.	o. r.	o. r.

Dimensions and specifications may be changed without prior notice.

o. r. = on request

VS-O stainless steel Screw plug



VS-O Stainless Steel

Screw plug made of stainless steel with an O-ring made by FKM.

Material

Stainless steel 1.4305 / AISI 303
O-ring: FKM

Technical data

Protection class: IP 68

Temperature range: -15°C up to +200°C

Application

- Plant and machine construction
- Robotics
- Automation technology
- Vehicle construction and shipbuilding
- Railway technology
- Installation technology
- Control cabinet construction

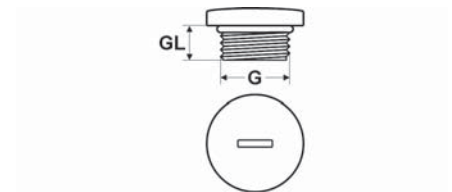

Dimensions

- G Thread size
- GL Thread length
- D Outer diameter
- H Height

Metric thread

Part no.	Size Metr.	Thread length mm	Outer Ø ca. mm	Height mm	Unit	Net EUR/100 items at a purchase of		
						up to 100	101 - 500	501 - 1000
905946	M12 x 1,5	5,0	14,0	7,5	10	o. r.	o. r.	o. r.
905947	M16 x 1,5	5,0	18,0	8,0	10	o. r.	o. r.	o. r.
905948	M20 x 1,5	6,5	22,0	9,5	10	o. r.	o. r.	o. r.
905949	M25 x 1,5	7,0	28,0	11,0	10	o. r.	o. r.	o. r.
905950	M32 x 1,5	8,0	35,0	12,0	5	o. r.	o. r.	o. r.
905951	M40 x 1,5	8,5	44,0	13,0	5	o. r.	o. r.	o. r.
905952	M50 x 1,5	9,0	54,0	15,0	2	o. r.	o. r.	o. r.
905953	M63 x 1,5	10,0	67,0	16,0	1	o. r.	o. r.	o. r.

Dimensions and specifications may be changed without prior notice.

o. r. = on request

O-ring FKM



O-ring FKM

O-rings for sealing against water, dust, and oil.
Made of FKM for large temperature range.

Application

- Plant and machine construction
- Robotics
- Automation technology
- Vehicle construction and shipbuilding
- Railway technology
- Installation technology
- Control cabinet construction

Material

FKM

- halogen-free
- phosphor-free
- silicone-free
- cadmium-free

Technical data

Temperature range: -40°C up to +200°C

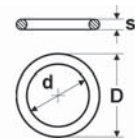

Dimensions

D Outer diameter
d Inner diameter
s Thickness

Metric thread

Part no.	Size metr.	Inner Ø mm	Outer Ø mm	Thickness mm	Unit	Net EUR/100 items at a purchase of		
						up to 100	101 - 500	501 - 1000
98594	M12 x 1,5	10,0	13,0	1,5	100	o. r.	o. r.	o. r.
98595	M16 x 1,5	12,0	15,0	1,5	100	o. r.	o. r.	o. r.
98596	M20 x 1,5	17,0	20,6	1,8	100	o. r.	o. r.	o. r.
904282	M25 x 1,5	22,0	26,0	2,0	100	o. r.	o. r.	o. r.
904283	M32 x 1,5	29,0	33,0	2,0	100	o. r.	o. r.	o. r.
904284	M40 x 1,5	35,0	39,0	2,0	50	o. r.	o. r.	o. r.
904285	M50 x 1,5	43,0	47,0	2,0	50	o. r.	o. r.	o. r.
904286	M63 x 1,5	55,0	59,0	2,0	50	o. r.	o. r.	o. r.

PG thread

Part no.	Size PG	Inner Ø mm	Outer Ø mm	Thickness mm	Unit	Net EUR/100 items at a purchase of		
						up to 100	101 - 500	501 - 1000
97753	7	10,0	13,0	1,5	100	o. r.	o. r.	o. r.
904287	9	12,0	15,0	1,5	100	o. r.	o. r.	o. r.
904288	11	16,0	19,6	1,8	100	o. r.	o. r.	o. r.
904289	13,5	17,0	20,6	1,8	100	o. r.	o. r.	o. r.
96662	16	18,0	21,0	1,5	100	o. r.	o. r.	o. r.
904290	21	26,0	30,0	2,0	100	o. r.	o. r.	o. r.
904291	29	33,0	37,0	2,0	50	o. r.	o. r.	o. r.
904292	36	43,0	47,0	2,0	50	o. r.	o. r.	o. r.
904293	42	50,0	54,0	2,0	25	o. r.	o. r.	o. r.
904294	48	55,0	59,0	2,0	25	o. r.	o. r.	o. r.

Dimensions and specifications may be changed without prior notice.

o. r. = on request

HSK-MS-EX-E
HSK-EX

VSK-EX

DMT 02 ATEX E 047 X  II 2 GD EEx e II

HELUTOP® HT-PA-EX

Explosive area



HELUTOP® HT-PA-EX

For use in explosive areas.

Application

Zone 1, Zone 2, Zone 21, Zone 22, IIA, IIB, IIC

Material

Polyamide PA 6
Seal: Chloroprene-rubber (CR)
O-ring: Chloroprene-rubber (CR)

- phosphor-free
- silicone-free
- cadmium-free

Note

Certificate of Conformity: IMQ 13 ATEX 010 X, IEC Ex IM2 13.003

Marking: Ex II 2GD Exe IIC Gb, Ex tb IIIC Db

Technical data

Protection class: IP 66 / IP 68 (EN 60529)
Impact-resistant: 4 Joule

Temperature range: -40°C up to +80°C

Test standard: EN 60079-0:2012 / EN 60079-7:2007 / EN 60079-11:2012 / EN 60079-31:2014 / IEC 60079-0:2011 / IEC 60079-7:2006 / IEC 60079-11:2011 / IEC 60079-31:2013

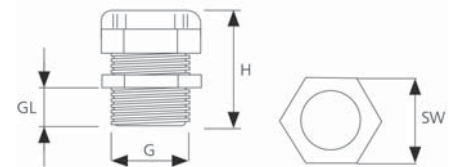

Part no. black	Size Metr.	Cable Ø from / to mm	Thread length mm	Spanner size mm	Height mm	Unit	Net EUR/100 items at a purchase of		
							up to 100	101 - 500	501 - 1000
906691	M20 x 1,5	6,0 - 12,0	10,0	24	39	50	o. r.	o. r.	o. r.
906938	M20 x 1,5	6,0 - 12,0	15,0	24	44	50	o. r.	o. r.	o. r.
906692	M20 x 1,5	10,0 - 14,0	10,0	27	41	50	o. r.	o. r.	o. r.
906939	M20 x 1,5	10,0 - 14,0	15,0	27	46	50	o. r.	o. r.	o. r.
906693	M25 x 1,5	13,0 - 18,0	10,0	33	47	25	o. r.	o. r.	o. r.
906940	M25 x 1,5	13,0 - 18,0	15,0	33	52	25	o. r.	o. r.	o. r.
906694	M25 x 1,5	11,0 - 17,0	8,0	29	43	50	o. r.	o. r.	o. r.
906695	M32 x 1,5	15,0 - 21,0	10,0	36	52	25	o. r.	o. r.	o. r.
906696	M32 x 1,5	18,0 - 25,0	15,0	42	56	25	o. r.	o. r.	o. r.
906697	M40 x 1,5	19,0 - 28,0	10,0	46	46	20	o. r.	o. r.	o. r.
906698	M40 x 1,5	22,0 - 32,0	18,0	53	69,5	10	o. r.	o. r.	o. r.
906699	M50 x 1,5	30,0 - 38,0	18,0	60	71,5	10	o. r.	o. r.	o. r.
906700	M63 x 1,5	34,0 - 44,0	18,0	65	71,5	10	o. r.	o. r.	o. r.

Dimensions and specifications may be changed without prior notice.

o. r. = on request

HELUTOP® HT-PA-EX-Plus

Explosive area

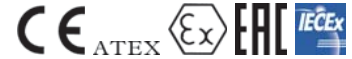

HELUTOP® HT-PA-EX-Plus

For use in explosive areas.

Application

- Zone 1, Zone 2, Zone 21, Zone 22, IIA, IIB, IIC

Material

Polyamide PA 6
Seal: Chloroprene-rubber (CR)
Flat seal: Chloroprene-rubber (CR)

- phosphor-free
- silicone-free
- cadmium-free

Note

For intrinsically safe area type "i", in blue on request.

Certificate of Conformity:

IMQ 13 ATEX 010 X
IECEx IMQ 13.0003X

Approval:

EX II 2GD
Ex e IIC Gb/Ex tb IIIC Db IP 66/68

Technical data

Protection class: IP 66 / IP 68
Impact-resistant: 7 Joule

Temperature range: -40°C up to +70°C

Test standard: EN 60079-0:2012 / EN 60079-7:2007 / EN 60079-11:2012 / EN 60079-31:2014 / IEC 60079-0:2011 / IEC 60079-7:2006 / IEC 60079-11:2011 / IEC 60079-31:2013

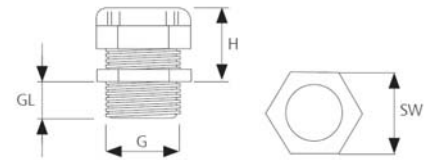

Dimensions

G Thread size
GL Thread length
H Height

Chloroprene sealing

Part no. black	Size Metr.	Cable Ø from / to mm	Thread length mm	Spanner size mm	Height mm	Unit	Net EUR/100 items at a purchase of		
							up to 100	101 - 500	501 - 1000
908080	M12 x 1,5	4,0 - 6,5	10,0	15	22	100	o. r.	o. r.	o. r.
908081	M12 x 1,5	4,0 - 6,5	15,0	15	22	100	o. r.	o. r.	o. r.
908082	M16 x 1,5	5,0 - 8,0	10,0	19	26	50	o. r.	o. r.	o. r.
908083	M16 x 1,5	6,0 - 10,0	10,0	22	29	50	o. r.	o. r.	o. r.
908084	M16 x 1,5	6,0 - 10,0	15,0	22	29	50	o. r.	o. r.	o. r.
908085	M20 x 1,5	6,0 - 10,0	10,0	24	29	50	o. r.	o. r.	o. r.
908086	M20 x 1,5	7,0 - 12,0	10,0	24	29	50	o. r.	o. r.	o. r.
908087	M20 x 1,5	7,0 - 12,0	15,0	24	29	50	o. r.	o. r.	o. r.
908088	M20 x 1,5	7,0 - 13,0	10,0	25	30,5	50	o. r.	o. r.	o. r.
908089	M20 x 1,5	11,0 - 14,0	10,0	27	29	50	o. r.	o. r.	o. r.
908090	M20 x 1,5	11,0 - 14,0	15,0	27	29	50	o. r.	o. r.	o. r.
908091	M25 x 1,5	11,0 - 14,0	10,0	27	29	25	o. r.	o. r.	o. r.
908092	M25 x 1,5	11,0 - 14,0	15,0	27	29	25	o. r.	o. r.	o. r.
908093	M25 x 1,5	12,0 - 17,0	15,0	29	35	25	o. r.	o. r.	o. r.
908094	M25 x 1,5	12,0 - 17,0	10,0	29	35	25	o. r.	o. r.	o. r.
908095	M25 x 1,5	14,0 - 18,0	10,0	33	37	25	o. r.	o. r.	o. r.
908096	M25 x 1,5	14,0 - 18,0	15,0	33	37	25	o. r.	o. r.	o. r.
908098	M32 x 1,5	16,0 - 21,0	10,0	36	42	20	o. r.	o. r.	o. r.
908099	M32 x 1,5	16,0 - 21,0	15,0	42	41	20	o. r.	o. r.	o. r.
908468	M32 x 1,5	19,0 - 25,0	15,0	42	40,5	20	o. r.	o. r.	o. r.
908100	M40 x 1,5	20,0 - 28,0	10,0	46	46	10	o. r.	o. r.	o. r.
908101	M40 x 1,5	20,0 - 28,0	15,0	46	46	10	o. r.	o. r.	o. r.
908102	M40 x 1,5	23,0 - 32,0	18,0	53	51,5	10	o. r.	o. r.	o. r.
908103	M50 x 1,5	31,0 - 38,0	18,0	60	53	10	o. r.	o. r.	o. r.
908104	M63 x 1,5	35,0 - 44,0	18,0	65	53,5	10	o. r.	o. r.	o. r.

Dimensions and specifications may be changed without prior notice.

o. r. = on request

HELUTOP® HT-PA-EX-Plus

Explosive area

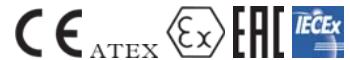

HELUTOP® HT-PA-EX-Plus

For use in explosive areas

Application

- Zone 1, Zone 2, Zone 21, Zone 22, IIA, IIB, IIC

Material

Polyamide PA 6
Seal: Silicone
Flat seal: Silicone

- phosphor-free
- cadmium-free

Note

For intrinsically safe area type "i", in blue on request.

Certificate of Conformity:

IMQ 13 ATEX 010 X
IECEx IMQ 13.0003X

Approval:

EX II 2GD
Ex e IIC Gb/Ex tb IIIC Db IP 66/68

Technical data

Protection class: IP 66 / IP 68
Impact-resistant: 7 Joule

Temperature range: -60°C up to +70°C

Test standard: EN 60079-0:2012 / EN 60079-7:2007 / EN 60079-11:2012 / EN 60079-31:2014 / IEC 60079-0:2011 / IEC 60079-7:2006 / IEC 60079-11:2011 / IEC 60079-31:2013

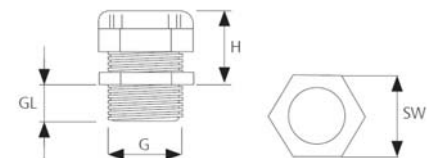

Dimensions

G Thread size
GL Thread length
H Height

Silicone sealing

Part no. black	Size Metr.	Cable Ø from / to mm	Thread length mm	Spanner size mm	Height mm	Unit	Net EUR/100 items at a purchase of		
							up to 100	101 - 500	501 - 1000
908105	M12 x 1,5	4,0 - 6,5	10,0	15	22	100	o. r.	o. r.	o. r.
908106	M12 x 1,5	4,0 - 6,5	15,0	15	22	100	o. r.	o. r.	o. r.
908107	M16 x 1,5	5,0 - 8,0	10,0	19	26	50	o. r.	o. r.	o. r.
908108	M16 x 1,5	6,0 - 10,0	10,0	22	29,5	50	o. r.	o. r.	o. r.
908109	M16 x 1,5	6,0 - 10,0	15,0	22	29	50	o. r.	o. r.	o. r.
908110	M20 x 1,5	6,0 - 10,0	10,0	24	29	50	o. r.	o. r.	o. r.
908111	M20 x 1,5	7,0 - 12,0	10,0	24	29	50	o. r.	o. r.	o. r.
908112	M20 x 1,5	7,0 - 12,0	15,0	24	29	50	o. r.	o. r.	o. r.
908113	M20 x 1,5	7,0 - 13,0	10,0	25	30,5	50	o. r.	o. r.	o. r.
908114	M20 x 1,5	11,0 - 14,0	10,0	27	29	50	o. r.	o. r.	o. r.
908115	M20 x 1,5	11,0 - 14,0	15,0	27	29	50	o. r.	o. r.	o. r.
908116	M25 x 1,5	11,0 - 14,0	10,0	27	29	25	o. r.	o. r.	o. r.
908117	M25 x 1,5	11,0 - 14,0	15,0	27	29	25	o. r.	o. r.	o. r.
908118	M25 x 1,5	12,0 - 17,0	15,0	29	35	25	o. r.	o. r.	o. r.
908119	M25 x 1,5	12,0 - 17,0	10,0	29	35	25	o. r.	o. r.	o. r.
908120	M25 x 1,5	14,0 - 18,0	10,0	33	37	25	o. r.	o. r.	o. r.
908121	M25 x 1,5	14,0 - 18,0	15,0	33	37	25	o. r.	o. r.	o. r.
908123	M32 x 1,5	16,0 - 21,0	10,0	36	42	20	o. r.	o. r.	o. r.
908124	M32 x 1,5	16,0 - 21,0	15,0	42	41	20	o. r.	o. r.	o. r.
908469	M32 x 1,5	19,0 - 25,0	15,0	42	40,5	20	o. r.	o. r.	o. r.
908125	M40 x 1,5	20,0 - 28,0	10,0	46	46	10	o. r.	o. r.	o. r.
908126	M40 x 1,5	20,0 - 28,0	15,0	46	46	10	o. r.	o. r.	o. r.
908127	M40 x 1,5	23,0 - 32,0	18,0	53	51,5	10	o. r.	o. r.	o. r.
908128	M50 x 1,5	31,0 - 38,0	18,0	60	53	10	o. r.	o. r.	o. r.
908129	M63 x 1,5	35,0 - 44,0	18,0	65	53,5	10	o. r.	o. r.	o. r.

Dimensions and specifications may be changed without prior notice.

o. r. = on request



HSK-EX

For use in explosive areas

Application

- Plant and machine construction
- Robotics
- Automation technology
- Vehicle construction and shipbuilding
- Railway technology
- Installation technology
- Control cabinet construction

Material

PA 6, V0 acc. to UL 94
Seal: NBR
O-ring: NBR

- halogen-free
- phosphor-free
- silicone-free
- cadmium-free

Properties

- Easy to assemble
- Completely water-tight
- Optimum strain relief
- Large clamping areas

Note

Certificate of Conformity:
EExell DMT 02 ATEX E 047 X

Technical data

Protection class: IP 68 - 10 bar / IP 69K

Temperature range: -20°C up to +95°C

Test standard: EN 60079-0:2006

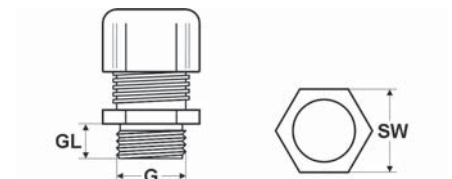

Dimensions

G Thread size
GL Thread length
SW Spanner size

Metric thread

Part no. light grey RAL 7035	Part no. black RAL 9005	Size Metr.	Cable Ø from / to mm	Thread length mm	Spanner size mm	Unit	Net EUR/ 100 items at a purchase of		
							up to 100	101 - 500	501 - 1000
97995	97986	M12 x 1,5	3,0 - 6,5	8,0	15	50	o. r.	o. r.	o. r.
97996	97987	M16 x 1,5	4,0 - 8,0	8,0	19	50	o. r.	o. r.	o. r.
97997	97988	M16 x 1,5	5,0 - 10,0	8,0	22	50	o. r.	o. r.	o. r.
97998	97156	M20 x 1,5	6,5 - 12,0	9,0	24	50	o. r.	o. r.	o. r.
97999	97989	M20 x 1,5	10,0 - 14,0	9,0	27	50	o. r.	o. r.	o. r.
98000	97990	M25 x 1,5	13,0 - 18,0	11,0	33	50	o. r.	o. r.	o. r.
98001	97991	M32 x 1,5	18,0 - 25,0	11,0	42	25	o. r.	o. r.	o. r.
98002	97992	M40 x 1,5	22,0 - 32,0	13,0	53	10	o. r.	o. r.	o. r.
98003	97993	M50 x 1,5	32,0 - 38,0	13,0	60	5	o. r.	o. r.	o. r.
98004	97994	M63 x 1,5	37,0 - 44,0	14,0	65 / 68	5	o. r.	o. r.	o. r.

Metric thread - for intrinsically safe application

Part no. blue RAL 5012	Size Metr.	Cable Ø from / to mm	Thread length mm	Spanner size mm	Unit	Net EUR/ 100 items at a purchase of		
						up to 100	101 - 500	501 - 1000
97962	M12 x 1,5	3,0 - 6,5	8,0	15	50	o. r.	o. r.	o. r.
97559	M16 x 1,5	4,0 - 8,0	8,0	19	50	o. r.	o. r.	o. r.
97963	M16 x 1,5	5,0 - 10,0	8,0	22	50	o. r.	o. r.	o. r.
96805	M20 x 1,5	6,5 - 12,0	9,0	24	50	o. r.	o. r.	o. r.
97964	M20 x 1,5	10,0 - 14,0	9,0	27	50	o. r.	o. r.	o. r.
97560	M25 x 1,5	13,0 - 18,0	11,0	33	50	o. r.	o. r.	o. r.
97561	M32 x 1,5	18,0 - 25,0	11,0	42	25	o. r.	o. r.	o. r.
97562	M40 x 1,5	22,0 - 32,0	13,0	53	10	o. r.	o. r.	o. r.
97563	M50 x 1,5	32,0 - 38,0	13,0	60	5	o. r.	o. r.	o. r.
97564	M63 x 1,5	37,0 - 44,0	14,0	65 / 68	5	o. r.	o. r.	o. r.

Continuation ▶

Explosive area

PG thread

Part no. light grey RAL 7035	Part no. black RAL 9005	Size PG	Cable Ø from / to mm	Thread length mm	Spanner size mm	Unit	Net EUR/100 items at a purchase of		
							up to 100	101 - 500	501 - 1000
96110	96116	7	3,0 - 6,5	8,0	15	50	o. r.	o. r.	o. r.
96111	96117	9	4,0 - 8,0	8,0	19	50	o. r.	o. r.	o. r.
96112	96225	11	5,0 - 10,0	8,0	22	50	o. r.	o. r.	o. r.
96113	96226	13,5	6,5 - 12,0	9,0	24	50	o. r.	o. r.	o. r.
96114	96119	16	10,0 - 14,0	10,0	27	50	o. r.	o. r.	o. r.
96115	96120	21	13,0 - 18,0	11,0	33	50	o. r.	o. r.	o. r.
96597	96121	29	18,0 - 25,0	11,0	42	25	o. r.	o. r.	o. r.
96598	96122	36	22,0 - 32,0	13,0	53	10	o. r.	o. r.	o. r.
96599	96601	42	32,0 - 38,0	13,0	60	5	o. r.	o. r.	o. r.
96600	96602	48	37,0 - 44,0	14,0	65	5	o. r.	o. r.	o. r.

PG thread - for intrinsically safe application

Part no. blue RAL 5012	Size PG	Cable Ø from / to mm	Thread length mm	Spanner size mm	Unit	Net EUR/100 items at a purchase of		
						up to 100	101 - 500	501 - 1000
90030	7	3,0 - 6,5	8,0	15	50	o. r.	o. r.	o. r.
90031	9	4,0 - 8,0	8,0	19	50	o. r.	o. r.	o. r.
90032	11	5,0 - 10,0	8,0	22	50	o. r.	o. r.	o. r.
90033	13,5	6,5 - 12,0	9,0	24	50	o. r.	o. r.	o. r.
90034	16	10,0 - 14,0	10,0	27	50	o. r.	o. r.	o. r.
90035	21	13,0 - 18,0	11,0	33	50	o. r.	o. r.	o. r.
90036	29	18,0 - 25,0	11,0	42	25	o. r.	o. r.	o. r.
90037	36	22,0 - 32,0	13,0	53	10	o. r.	o. r.	o. r.
90038	42	32,0 - 38,0	13,0	60	5	o. r.	o. r.	o. r.
90039	48	37,0 - 44,0	14,0	65	5	o. r.	o. r.	o. r.

NPT thread

Part no. light grey RAL 7035	Part no. black RAL 9005	Size NPT	Cable Ø from / to mm	Thread length mm	Spanner size mm	Unit	Net EUR/100 items at a purchase of		
							up to 100	101 - 500	501 - 1000
92640	92650	3/8"	4,0 - 8,0	15,0	19 / 22	50	o. r.	o. r.	o. r.
92641	92651	1/2"	6,5 - 12,0	13,0	24	50	o. r.	o. r.	o. r.
92642	92652	1/2"	10,0 - 14,0	13,0	27	50	o. r.	o. r.	o. r.
92643	92653	3/4"	13,0 - 18,0	14,0	33	50	o. r.	o. r.	o. r.
92644	92654	1"	18,0 - 25,0	19,0	42	25	o. r.	o. r.	o. r.
92645	92655	1,25"	18,0 - 25,0	16,0	42 / 46	25	o. r.	o. r.	o. r.
92646	92656	1,5"	22,0 - 32,0	20,0	53	10	o. r.	o. r.	o. r.

NPT thread - for intrinsically safe application

Part no. blue RAL 5012	Size NPT	Cable Ø from / to mm	Thread length mm	Spanner size mm	Unit	Net EUR/100 items at a purchase of		
						up to 100	101 - 500	501 - 1000
92660	3/8"	4,0 - 8,0	15,0	19 / 22	50	o. r.	o. r.	o. r.
92661	1/2"	6,5 - 12,0	13,0	24	50	o. r.	o. r.	o. r.
92662	1/2"	10,0 - 14,0	13,0	27	50	o. r.	o. r.	o. r.
92663	3/4"	13,0 - 18,0	14,0	33	50	o. r.	o. r.	o. r.
92664	1"	18,0 - 25,0	19,0	42	25	o. r.	o. r.	o. r.
92665	1,25"	18,0 - 25,0	16,0	42 / 46	25	o. r.	o. r.	o. r.
92666	1,5"	22,0 - 32,0	20,0	53	10	o. r.	o. r.	o. r.

Dimensions and specifications may be changed without prior notice.

o. r. = on request

HSK-EX-Active Cable gland

Explosive area



HSK-EX-Active

For use in explosive areas

Application

- Plant and machine construction
- Robotics
- Automation technology
- Vehicle construction and shipbuilding
- Railway technology
- Installation technology
- Control cabinet construction

Material

Fibreglass reinforced polyamide V0 acc. to UL 94
Seal: NBR
O-ring: NBR

- halogen-free
- phosphor-free
- silicone-free
- cadmium-free

Properties

- Easy to assemble
- Completely water-tight
- Optimum strain relief
- Large clamping areas

Note

EC-Type Examination Certificate:
BVS 14 ATEX E 025 X

IECEx Certificate of Conformity:
IECEx BVS 14.0020X

Marking:

II 2G Ex e IIC Gb, II 1D Ex ta IIIC Da

Technical data

Protection class: IP 68 – 10 bar acc. to DIN EN 60529

Temperature range: -20°C up to +85°C

Test standard: EN 60079-0:2012 / EN 60079-7:2007 / EN 60079-31:2011 / IEC 60079-0:2011 / IEC 60079-7:2007 / IEC 60079-31:2013

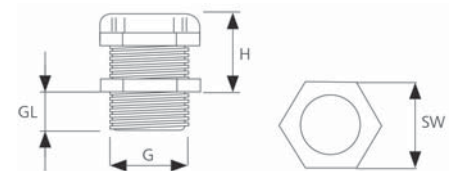

Abmessungen

G Thread size
GL Thread length
SW Spanner size
H Height

Metric thread

Part no. black RAL 9005	Size Metr.	Cable Ø from / to mm	Thread length mm	Spanner size mm	Height mm	Unit	Net EUR/100 items at a purchase of		
							up to 100	101 - 500	501 - 1000
908540	M12 x 1,5	3,0 - 6,5	8,0	15	21	50	o. r.	o. r.	o. r.
908541	M16 x 1,5	4,0 - 8,0	8,0	19	22	50	o. r.	o. r.	o. r.
908542	M16 x 1,5	5,0 - 10,0	8,0	22	25	50	o. r.	o. r.	o. r.
908543	M20 x 1,5	6,0 - 12,0	9,0	24	27	50	o. r.	o. r.	o. r.
908544	M20 x 1,5	10,0 - 14,0	9,0	27	28	50	o. r.	o. r.	o. r.
908545	M25 x 1,5	13,0 - 18,0	11,0	33	31	50	o. r.	o. r.	o. r.
908546	M32 x 1,5	18,0 - 25,0	11,0	42	39	25	o. r.	o. r.	o. r.
908547	M40 x 1,5	22,0 - 32,0	13,0	53	48	10	o. r.	o. r.	o. r.
908548	M50 x 1,5	32,0 - 38,0	13,0	60	49	5	o. r.	o. r.	o. r.
908549	M63 x 1,5	37,0 - 44,0	14,0	65 / 68	49	5	o. r.	o. r.	o. r.

Metric thread - with reducing seal

Part no. black RAL 9005	Size Metr.	Cable Ø from / to mm	Thread length mm	Spanner size mm	Height mm	Unit	Net EUR/100 items at a purchase of		
							up to 100	101 - 500	501 - 1000
908550	M12 x 1,5	2,0 - 5,0	8,0	15	21	50	o. r.	o. r.	o. r.
908551	M16 x 1,5	3,0 - 6,0	8,0	19	22	50	o. r.	o. r.	o. r.
908552	M16 x 1,5	3,0 - 7,0	8,0	22	25	50	o. r.	o. r.	o. r.
908553	M20 x 1,5	5,0 - 9,0	9,0	24	27	50	o. r.	o. r.	o. r.
908554	M20 x 1,5	7,0 - 12,0	9,0	27	28	50	o. r.	o. r.	o. r.
908555	M25 x 1,5	9,0 - 16,0	11,0	33	31	50	o. r.	o. r.	o. r.
908556	M32 x 1,5	13,0 - 20,0	11,0	42	39	25	o. r.	o. r.	o. r.
908557	M40 x 1,5	20,0 - 26,0	13,0	53	48	10	o. r.	o. r.	o. r.
908558	M50 x 1,5	25,0 - 31,0	13,0	60	49	5	o. r.	o. r.	o. r.
908559	M63 x 1,5	29,0 - 35,0	14,0	65 / 68	49	5	o. r.	o. r.	o. r.

Dimensions and specifications may be changed without prior notice.

o. r. = on request

HELUTOP® HT-MS-EX-d Cable gland

Brass, explosive area, pressure resistant



HELUTOP® HT-MS-EX-d

For use in explosive areas

Application

- Zone 1, Zone 2, Zone 21, Zone 22, IIA, IIB, IIC

Material

Brass, nickel plated
Clamp: Polyamide PA 6
Seal: Chloroprene-rubber (CR)
O-ring: Chloroprene-rubber (CR)

Note

Certificate of Conformity:

IMQ 11 ATEX 018X

Marking: Ex-d, Ex-e, EX II 2GD, Exd IIC Gb, Exe IIC Gb, Ex t IIIC DB

Stainless steel 1.4404 and other temperature ranges available on request.

Unit: 1 pcs

Technical data

Protection class: IP 66 / IP 68 (EN 60529)

Temperature range: -40°C up to +80°C

Test standard: EN 60079-0:2012 / EN 60079-1:2007 / EN 60079-7:2007 / EN 60079-11:2012 / EN 60079-31:2014 / IEC 60079-0:2012 / IEC 60079-1:2014 / IEC 60079-7:2006 / IEC 60079-11:2011 / IEC 60079-31:2013

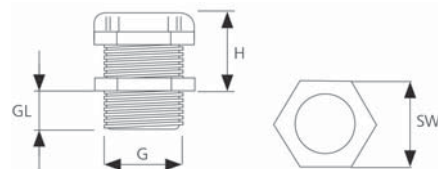

Dimensions

G Thread size
GL Thread length
SW Spanner size

Metric thread

Part no.	Size Metr.	Cable Ø from / to mm	Thread length mm	Spanner size mm	Height mm	Net EUR/100 items
906941	M16 x 1,5	4,0 - 12,0	16,0	22	31	o. r.
906942	M20 x 1,5	4,0 - 12,0	16,0	22	27	o. r.
906943	M20 x 1,5	10,0 - 16,0	16,0	28	30	o. r.
906944	M25 x 1,5	10,0 - 18,0	16,0	28	30,5	o. r.
906945	M25 x 1,5	14,0 - 20,0	16,0	35	34	o. r.
906946	M32 x 1,5	14,0 - 24,0	16,0	35	33	o. r.
906947	M32 x 1,5	22,0 - 28,0	16,0	45	41	o. r.
906948	M40 x 1,5	22,0 - 32,0	18,0	45	41	o. r.
906949	M40 x 1,5	26,0 - 34,0	18,0	50	44	o. r.
906950	M50 x 1,5	26,0 - 35,0	18,0	55 / 50	44	o. r.
906951	M50 x 1,5	35,0 - 44,0	18,0	64	43	o. r.
906952	M63 x 1,5	35,0 - 45,0	18,0	68 / 64	43	o. r.
906953	M63 x 1,5	46,0 - 56,0	20,0	75 / 80	52,5	o. r.
906954	M75 x 1,5	46,0 - 62,0	20,0	80	52	o. r.
906955	M75 x 1,5	60,0 - 69,0	20,0	95	55	o. r.
906956	M90 x 1,5	60,0 - 75,0	20,0	95	55	o. r.
906957	M90 x 1,5	75,0 - 82,0	20,0	105	55	o. r.
906958	M100 x 1,5	75,0 - 85,0	20,0	105	55	o. r.
906982	M110 x 1,5	85,0 - 95,0	20,0	115	57	o. r.

Dimensions and specifications may be changed without prior notice.

o. r. = on request

HELUTOP® HT-MS-EX-d 1 EMV

Brass, explosive area, pressure resistant



HELUTOP® HT-MS-EX-d 1 EMV

For use in explosive areas. For cables with braided hose, copper tinned (EMC)

Application

- Zone 1, Zone 2, Zone 21, Zone 22, IIA, IIB, IIC

Material

Brass, nickel plated
Contact system: Copper-Beryllium
Clamp: Polyamide PA 6
Seal: Chloroprene-rubber (CR)
O-ring: Chloroprene-rubber (CR)

Note

Also available in stainless steel 1.4404, further sizes or for other temperature ranges on request.

Certificate of Conformity: IMQ 11 ATEX 018 X

Marking: Ex-d, Ex-e EX II 2GD Ex d IIC Gb, Ex e IIC Gb, Ex tb III CDb

Unit: 1 pcs

Technical data

Protection class: IP 66 / IP 68 (EN 60529)

Temperature range: -40°C up to +80°C

Test standard: EN 60079-0:2012 / EN 60079-1:2007 / EN 60079-7:2007 / EN 60079-11:2012 / EN 60079-31:2014 / IEC 60079-0:2012 / IEC 60079-1:2014 / IEC 60079-7:2016 / IEC 60079-11:2011 / IEC 60079-31:2013

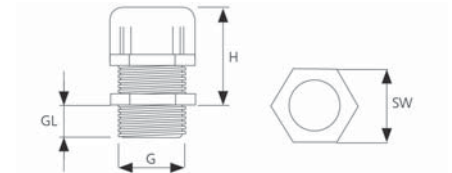

Dimensions

GL Thread length
G Thread size
H Height without thread
SW Spanner size

Metric thread

Part no.	Size Metr.	Cable Ø from / to mm	Thread length mm	Spanner size mm	Height mm	Net EUR/100 items
906959	M16 x 1,5	4,0 - 8,0	16,0	22	28,5	o. r.
906960	M20 x 1,5	4,0 - 12,0	18,0	22	27	o. r.
906961	M25 x 1,5	10,0 - 18,0	16,0	28	30,5	o. r.
906962	M32 x 1,5	14,0 - 24,0	19,0	35	33	o. r.
906963	M40 x 1,5	22,0 - 32,0	20,0	45	40,5	o. r.
906964	M50 x 1,5	26,0 - 35,0	20,0	55 / 50	43,5	o. r.

Dimensions and specifications may be changed without prior notice.

o. r. = on request

HELUTOP® HT-MS-EX-d / e4

Brass, explosive areas, for armoured cables



HELUTOP® HT-MS-EX-d / e4

For use in explosive areas. For armoured cables (copper or steel).

Application

- Zone 1, Zone 2, Zone 21, Zone 22, IIA, IIB, IIC

Material

Brass, nickel plated
Clamp: Polyamide PA 6
Seal: NBR
O-ring: NBR

Properties

- Sealing
- Strain relief
- EMC
- Explosive protection

Note

Stainless steel 1.4404 and other temperature ranges on request.

PVC shrouds and earth tags on request.

Certificate of Conformity: CESI 13 ATEX 033X, IECEx CES 13.0013X

Marking: Ex II 2 GD, Exd IIC Gb / Exe IIC Gb, Extb IIIC Db

Unit: 1 pcs

Technical data

Protection class: IP 66 / IP 68

Temperature range: -40°C up to +100°C

Test standard: EN 60079-0:2012 / EN 60079-1:2007 / EN 60079-7:2007 / EN 60079-31:2009 / IEC 60079-0:2011
Edition:6.0 / IEC 60079-1:2007-04 Edition: 6.0 / IEC 60079-31:2008 Edition:1 / IEC 60079-7:2006-07 Edition:4

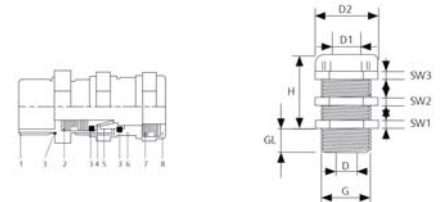

Dimensions:

- 1 Lower body
- 2 Lower sealing ring
- 3 O-Ring
- 4 Grounding cone
- 5 Swivel braid retainer
- 6 Middle body
- 7 Upper sealing ring
- 8 Pressure cap

Metric thread

Part no.	Size Metr.	Cable Ø Inner sheath from / to mm	Cable Ø Outer sheath from / to mm	Thread length mm	Spanner size mm	Angle size D2 mm	Height mm	Net EUR/ 100 items
906965	M16 x 1,5	3,0 - 8,5	6,0 - 12,0	16,0	22 / 26	29,0	47	o. r.
906966	M16 x 1,5	6,0 - 12,0	8,5 - 16,0	16,0	25 / 29	31,5	48	o. r.
906967	M20 x 1,5	3,0 - 8,5	6,0 - 12,0	16,0	24 / 26	29,0	47	o. r.
906968	M20 x 1,5	6,0 - 12,0	8,5 - 16,0	16,0	25 / 29	31,5	47	o. r.
906970	M25 x 1,5	6,0 - 12,0	8,5 - 16,0	18,0	29 / 29	31,5	48	o. r.
906972	M25 x 1,5	12,0 - 20,0	16,0 - 26,0	18,0	36 / 40	44,0	60	o. r.
906973	M32 x 1,5	12,0 - 20,0	16,0 - 26,0	18,0	40 / 40	44,0	62	o. r.
906974	M32 x 1,5	15,0 - 26,0	20,0 - 33,0	18,0	48 / 52	57,0	78	o. r.
906975	M40 x 1,5	15,0 - 26,0	20,0 - 33,0	18,0	48 / 52	57,0	78	o. r.
906976	M40 x 1,5	20,0 - 32,0	29,0 - 41,0	18,0	55 / 60	66,0	89	o. r.
906977	M50 x 1,5	22,0 - 35,0	33,0 - 48,0	18,0	60 / 70	82,0	97	o. r.
906978	M50 x 1,5	27,0 - 41,0	36,0 - 52,0	18,0	70 / 70	83,0	100	o. r.
906979	M63 x 1,5	35,0 - 45,0	43,0 - 57,0	20,0	75 / 80	89,5	106	o. r.
906980	M63 x 1,5	40,0 - 52,0	47,0 - 60,0	20,0	85 / 85	94,0	107	o. r.
906981	M75 x 1,5	40,0 - 52,0	47,0 - 60,0	20,0	85 / 85	94,0	107	o. r.

Dimensions and specifications may be changed without prior notice.

o. r. = on request

HSK-MS-EX Cable gland

Brass - explosive area



HSK-MS-EX

For use in explosive areas

Application

- Plant and machine construction
- Automation technology
- Control cabinet construction
- Installation technology

Material

Brass, nickel plated
 Clamp: Polyamide PA 6
 Seal: NBR
 O-ring: NBR

Properties

- Easy to assemble
- Completely water-tight
- Optimum strain relief
- Large clamping areas

Note

Certificate of Conformity:
 DMT 03 ATEX E 051 X

Technical data

Protection class: IP 68 - 10 bar / IP 69K

Temperature range: -20°C up to +95°C

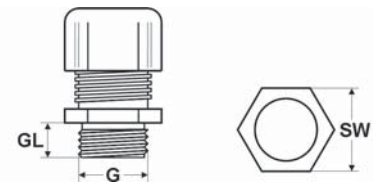

Dimensions

G Thread size
 GL Thread length
 SW Spanner size

Metric thread

Part no.	Size Metr.	Cable Ø from / to mm	Thread length mm	Spanner size mm	Unit	Net EUR/ 100 items at a purchase of		
						up to 100	101 - 500	501 - 1000
98045	M12 x 1,5	3,0 - 6,5	6,5	14	50	o. r.	o. r.	o. r.
98046	M16 x 1,5	4,0 - 8,0	6,0	17 / 19	50	o. r.	o. r.	o. r.
98047	M16 x 1,5	6,0 - 10,0	6,0	20	50	o. r.	o. r.	o. r.
98048	M20 x 1,5	6,0 - 12,0	6,0	22	50	o. r.	o. r.	o. r.
98049	M20 x 1,5	10,0 - 14,0	6,0	24	50	o. r.	o. r.	o. r.
98050	M25 x 1,5	14,0 - 18,0	7,0	30	25	o. r.	o. r.	o. r.
98051	M32 x 1,5	20,0 - 25,0	8,0	40	25	o. r.	o. r.	o. r.
98052	M40 x 1,5	22,0 - 32,0	8,0	50	10	o. r.	o. r.	o. r.
98053	M50 x 1,5	32,0 - 38,0	9,0	57	5	o. r.	o. r.	o. r.
98054	M63 x 1,5	37,0 - 44,0	10,0	64 / 68	5	o. r.	o. r.	o. r.

PG thread

Part no.	Size PG	Cable Ø from / to mm	Thread length mm	Spanner size mm	Unit	Net EUR/ 100 items at a purchase of		
						up to 100	101 - 500	501 - 1000
90200	7	3,0 - 6,5	5,0	14	50	o. r.	o. r.	o. r.
90201	9	4,0 - 8,0	6,0	17	50	o. r.	o. r.	o. r.
90202	11	6,0 - 10,0	6,0	20	50	o. r.	o. r.	o. r.
90203	13,5	6,0 - 12,0	6,5	22	50	o. r.	o. r.	o. r.
90204	16	10,0 - 14,0	6,5	24	50	o. r.	o. r.	o. r.
90205	21	14,0 - 18,0	7,0	30	25	o. r.	o. r.	o. r.
90206	29	20,0 - 25,0	8,0	40	25	o. r.	o. r.	o. r.
90207	36	22,0 - 32,0	8,0	50	10	o. r.	o. r.	o. r.
90208	42	32,0 - 38,0	9,0	57	5	o. r.	o. r.	o. r.
90209	48	37,0 - 44,0	10,0	64	5	o. r.	o. r.	o. r.

NPT thread

Part no.	Size NPT	Cable Ø from / to mm	Thread length mm	Spanner size mm	Unit	Net EUR/ 100 items at a purchase of		
						up to 100	101 - 500	501 - 1000
92900	3/8"	4,0 - 8,0	15,0	17 / 19	50	o. r.	o. r.	o. r.
92901	1/2"	6,0 - 12,0	13,0	22 / 24	50	o. r.	o. r.	o. r.
92902	3/4"	14,0 - 18,0	13,0	30	25	o. r.	o. r.	o. r.
92903	1"	20,0 - 25,0	19,0	40	25	o. r.	o. r.	o. r.

Dimensions and specifications may be changed without prior notice.

o. r. = on request

HSK-MS-EX-E Cable gland

Brass - explosive area - EMC

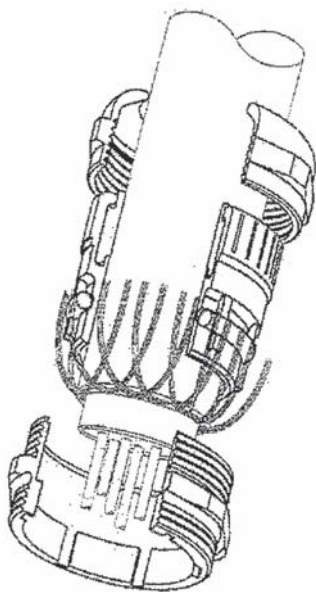

HSK-MS-EX-E

EMC cable gland for use in explosive areas.

Application

- Plant and machine construction
- Automation technology
- Vehicle construction and shipbuilding
- Installation technology

Material

Brass, nickel plated
Clamp: Polyamide PA 6
Seal: NBR
O-ring: NBR

Properties

- Easy to assemble
- Completely water-tight
- Optimum strain relief
- Large clamping areas

Note

Certificate of Conformity:
DMT 03 ATEX E 051 X

Technical data

Protection class: IP 68 - 10 bar / IP 69K

Temperature range: -20°C up to +95°C

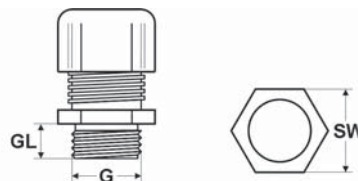

Dimensions

G Thread size
GL Thread length
SW Spanner size

Metric thread

Part no.	Size Metr.	Cable Ø from / to mm	Thread length mm	Spanner size mm	Unit	Net EUR/100 items at a purchase of		
						up to 100	101 - 500	501 - 1000
92880	M12 x 1,5	3,0 - 6,5	6,5	14	50	o. r.	o. r.	o. r.
92881	M16 x 1,5	6,0 - 10,0	6,0	20	50	o. r.	o. r.	o. r.
92882	M20 x 1,5	10,0 - 14,0	6,0	24	50	o. r.	o. r.	o. r.
92883	M25 x 1,5	14,0 - 18,0	7,0	30	25	o. r.	o. r.	o. r.
92884	M32 x 1,5	20,0 - 25,0	8,0	40	25	o. r.	o. r.	o. r.
92885	M40 x 1,5	22,0 - 32,0	8,0	50	10	o. r.	o. r.	o. r.
92886	M50 x 1,5	32,0 - 38,0	9,0	57	5	o. r.	o. r.	o. r.
92887	M63 x 1,5	37,0 - 44,0	10,0	64 / 68	5	o. r.	o. r.	o. r.

PG thread

Part no.	Size PG	Cable Ø from / to mm	Thread length mm	Spanner size mm	Unit	Net EUR/100 items at a purchase of		
						up to 100	101 - 500	501 - 1000
92870	7	3,0 - 6,5	5,0	14	50	o. r.	o. r.	o. r.
92871	9	4,0 - 8,0	6,0	17	50	o. r.	o. r.	o. r.
92872	11	6,0 - 10,0	6,0	20	50	o. r.	o. r.	o. r.
92873	13,5	6,0 - 12,0	6,5	22	50	o. r.	o. r.	o. r.
92874	16	10,0 - 14,0	6,5	24	50	o. r.	o. r.	o. r.
92875	21	14,0 - 18,0	7,0	30	25	o. r.	o. r.	o. r.
92876	29	20,0 - 25,0	8,0	40	25	o. r.	o. r.	o. r.
92877	36	22,0 - 32,0	8,0	50	10	o. r.	o. r.	o. r.
92878	42	32,0 - 38,0	9,0	57	5	o. r.	o. r.	o. r.
92879	48	37,0 - 44,0	10,0	64	5	o. r.	o. r.	o. r.

NPT thread

Part no.	Size NPT	Cable Ø from / to mm	Thread length mm	Spanner size mm	Unit	Net EUR/100 items at a purchase of		
						up to 100	101 - 500	501 - 1000
92890	3/8"	4,0 - 8,0	15,0	17 / 19	50	o. r.	o. r.	o. r.
92891	1/2"	6,0 - 12,0	13,0	22 / 24	50	o. r.	o. r.	o. r.
92892	3/4"	14,0 - 18,0	13,0	30	25	o. r.	o. r.	o. r.

Dimensions and specifications may be changed without prior notice.

o. r. = on request

Adapter PA-ATEX

Explosive area



Adapter PA-ATEX

Adapter made of polyamide for thread adjustment from PG to metric, for use in explosive areas.

Application

- Plant and machine construction
- Robotics
- Automation technology
- Vehicle construction and shipbuilding
- Installation technology
- Control cabinet construction

Material

Polyamide

Colour: black
RAL: 9005

- halogen-free
- phosphor-free
- silicone-free
- cadmium-free

Note

Approval: PTB 04 ATEX 1040 X

Technical data

Protection class: IP 66

Temperature range: -20°C up to +70°C

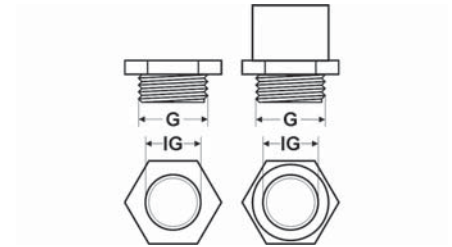

Dimensions

G Thread size outside
IG Thread size inside

From PG to metric

Part no.	Size PG outside	Size metr. inside	Unit	Net EUR/100 items at a purchase of		
				up to 100	101 - 500	501 - 1000
904449	21	M20 x 1,5	10	o. r.	o. r.	o. r.
904450	29	M20 x 1,5	10	o. r.	o. r.	o. r.
904451	29	M25 x 1,5	10	o. r.	o. r.	o. r.
904452	29	M32 x 1,5	10	o. r.	o. r.	o. r.
904454	36	M25 x 1,5	10	o. r.	o. r.	o. r.
904455	36	M32 x 1,5	10	o. r.	o. r.	o. r.
904456	36	M40 x 1,5	10	o. r.	o. r.	o. r.
904457	42	M20 x 1,5	5	o. r.	o. r.	o. r.
904458	42	M25 x 1,5	5	o. r.	o. r.	o. r.
904459	42	M32 x 1,5	5	o. r.	o. r.	o. r.
904460	42	M40 x 1,5	5	o. r.	o. r.	o. r.
904461	48	M20 x 1,5	5	o. r.	o. r.	o. r.
904462	48	M25 x 1,5	5	o. r.	o. r.	o. r.
904463	48	M32 x 1,5	5	o. r.	o. r.	o. r.
904464	48	M40 x 1,5	5	o. r.	o. r.	o. r.
904465	48	M50 x 1,5	5	o. r.	o. r.	o. r.

Continuation ►

Adapter PA-ATEX



Explosive area

From PG to metric - high-profile design

Part no.	Size PG outside	Size metr. inside	Unit	Net EUR/100 items at a purchase of		
				up to 100	101 - 500	501 - 1000
904466	7	M12 x 1,5	25	o. r.	o. r.	o. r.
904467	7	M16 x 1,5	25	o. r.	o. r.	o. r.
904468	9	M12 x 1,5	25	o. r.	o. r.	o. r.
904469	9	M16 x 1,5	25	o. r.	o. r.	o. r.
904470	9	M20 x 1,5	25	o. r.	o. r.	o. r.
904471	11	M16 x 1,5	25	o. r.	o. r.	o. r.
904472	11	M20 x 1,5	25	o. r.	o. r.	o. r.
904473	11	M25 x 1,5	25	o. r.	o. r.	o. r.
904474	13,5	M16 x 1,5	25	o. r.	o. r.	o. r.
904475	13,5	M20 x 1,5	25	o. r.	o. r.	o. r.
904476	13,5	M25 x 1,5	25	o. r.	o. r.	o. r.
904477	16	M20 x 1,5	25	o. r.	o. r.	o. r.
904478	16	M25 x 1,5	25	o. r.	o. r.	o. r.
904479	16	M32 x 1,5	25	o. r.	o. r.	o. r.
904480	21	M25 x 1,5	10	o. r.	o. r.	o. r.
904481	21	M32 x 1,5	10	o. r.	o. r.	o. r.
904482	21	M40 x 1,5	10	o. r.	o. r.	o. r.
904483	29	M40 x 1,5	10	o. r.	o. r.	o. r.
904484	29	M50 x 1,5	10	o. r.	o. r.	o. r.
904485	36	M50 x 1,5	10	o. r.	o. r.	o. r.
904486	36	M63 x 1,5	10	o. r.	o. r.	o. r.
904487	42	M50 x 1,5	5	o. r.	o. r.	o. r.
904488	42	M63 x 1,5	5	o. r.	o. r.	o. r.
904489	48	M63 x 1,5	5	o. r.	o. r.	o. r.

Dimensions and specifications may be changed without prior notice.

o. r. = on request

Explosive area



EW PA-ATEX

Extender made of polyamide for use in explosive areas.
Transition from small to large thread.

Application

- Plant and machine construction
- Robotics
- Automation technology
- Vehicle construction and shipbuilding
- Installation technology
- Control cabinet construction

Material

Polyamide

Colour: black
RAL: 9005

- halogen-free
- phosphor-free
- silicone-free
- cadmium-free

Note

Approval: PTB 04 ATEX 1040X

Technical data

Protection class: IP 66

Temperature range: -20°C up to +70°C

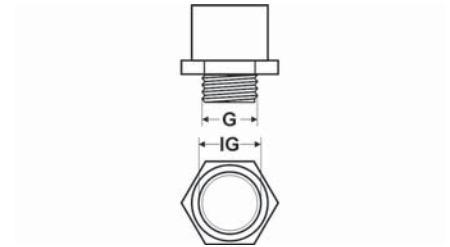

Dimensions

G Thread size outside
IG Thread size inside

From metric to metric

Part no.	Size metr. outside	Size metr. inside	Unit	Net EUR/100 items at a purchase of		
				up to 100	101 - 500	501 - 1000
904421	M12 x 1,5	M16 x 1,5	100	o. r.	o. r.	o. r.
904422	M16 x 1,5	M20 x 1,5	100	o. r.	o. r.	o. r.
904423	M20 x 1,5	M25 x 1,5	100	o. r.	o. r.	o. r.
904424	M25 x 1,5	M32 x 1,5	100	o. r.	o. r.	o. r.
904425	M32 x 1,5	M40 x 1,5	50	o. r.	o. r.	o. r.
904426	M40 x 1,5	M50 x 1,5	25	o. r.	o. r.	o. r.
904427	M50 x 1,5	M63 x 1,5	25	o. r.	o. r.	o. r.

Dimensions and specifications may be changed without prior notice.

o. r. = on request

RE PA-ATEX Reducer



Explosive area



RE PA-ATEX

Reducer made of polyamide for use in explosive areas.
Transition from large to small thread.

Application

- Plant and machine construction
- Robotics
- Automation technology
- Vehicle construction and shipbuilding
- Installation technology
- Control cabinet construction

Material

Polyamide

Colour: black
RAL: 9005

- halogen-free
- phosphor-free
- silicone-free
- cadmium-free

Note

Approval: PTB 04 ATEX 1040X

Technical data

Protection class: IP 66

Temperature range: -20°C up to +70°C

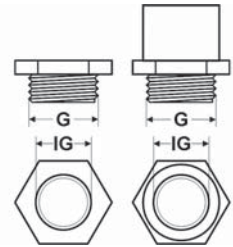

Dimensions

G Thread size outside
IG Thread size inside

From metric to metric

Part no.	Size metr. outside	Size metr. inside	Unit	Net EUR/100 items at a purchase of		
				up to 100	101 - 500	501 - 1000
904428	M25 x 1,5	M12 x 1,5	100	o. r.	o. r.	o. r.
904429	M25 x 1,5	M16 x 1,5	100	o. r.	o. r.	o. r.
904430	M25 x 1,5	M20 x 1,5	100	o. r.	o. r.	o. r.
904431	M32 x 1,5	M16 x 1,5	50	o. r.	o. r.	o. r.
904432	M32 x 1,5	M20 x 1,5	50	o. r.	o. r.	o. r.
904433	M32 x 1,5	M25 x 1,5	50	o. r.	o. r.	o. r.
904434	M40 x 1,5	M20 x 1,5	25	o. r.	o. r.	o. r.
904435	M40 x 1,5	M25 x 1,5	25	o. r.	o. r.	o. r.
904436	M40 x 1,5	M32 x 1,5	25	o. r.	o. r.	o. r.
904437	M50 x 1,5	M20 x 1,5	5	o. r.	o. r.	o. r.
904438	M50 x 1,5	M25 x 1,5	5	o. r.	o. r.	o. r.
904439	M50 x 1,5	M32 x 1,5	5	o. r.	o. r.	o. r.
904440	M50 x 1,5	M40 x 1,5	5	o. r.	o. r.	o. r.
904441	M63 x 1,5	M20 x 1,5	5	o. r.	o. r.	o. r.
904442	M63 x 1,5	M25 x 1,5	5	o. r.	o. r.	o. r.
904443	M63 x 1,5	M32 x 1,5	5	o. r.	o. r.	o. r.
904444	M63 x 1,5	M40 x 1,5	5	o. r.	o. r.	o. r.
904445	M63 x 1,5	M50 x 1,5	5	o. r.	o. r.	o. r.

From metric to metric - high-profile design

Part no.	Size metr. outside	Size metr. inside	Unit	Net EUR/100 items at a purchase of		
				up to 100	101 - 500	501 - 1000
904446	M16 x 1,5	M12 x 1,5	100	o. r.	o. r.	o. r.
904448	M20 x 1,5	M16 x 1,5	100	o. r.	o. r.	o. r.

Dimensions and specifications may be changed without prior notice.

o. r. = on request

VSK-EX Screw plug

Explosive area



VSK-EX

Screwed plug for explosive area to DIN EN 50014 and DIN EN 50019.

Application

- Plant and machine construction
- Robotics
- Automation technology
- Vehicle construction and shipbuilding
- Railway technology
- Installation technology
- Control cabinet construction

Material

Polyamide
O-ring: NBR

Colour: black
RAL: 9005

- halogen-free
- phosphor-free

Note

Approval: DMT 03 ATEX E 049

Technical data

Protection class: IP 68 - 10 bar / IP 69K

Temperature range: -20°C up to +90°C

Test standard: EN 60079-0:2012 / EN 60079-7:2007 / EN 60079-31:2014

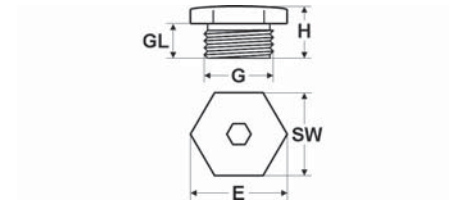

Dimensions

- G Thread size
- GL Thread length
- H Height
- SW Spanner size
- E Angle size

Metric thread

Part no. black RAL 9005	Size Metr.	Thread length mm	Height mm	Spanner size mm	Angle size mm	Unit	Net EUR/100 items at a purchase of		
							up to 100	101 - 500	501 - 1000
98114	M12 x 1,5	8,5	13,0	15	16,5	100	o. r.	o. r.	o. r.
98115	M16 x 1,5	8,5	13,0	19	20,5	100	o. r.	o. r.	o. r.
96793	M20 x 1,5	9,0	14,5	24	25,5	100	o. r.	o. r.	o. r.
98116	M25 x 1,5	10,5	16,0	28	30,5	100	o. r.	o. r.	o. r.
97763	M32 x 1,5	11,5	17,5	36	38,0	50	o. r.	o. r.	o. r.
98117	M40 x 1,5	11,5	18,0	46	48,0	25	o. r.	o. r.	o. r.
98118	M50 x 1,5	13,5	20,0	55	60,0	20	o. r.	o. r.	o. r.
98119	M63 x 1,5	14,5	21,0	70	75,0	20	o. r.	o. r.	o. r.

PG thread

Part no. black RAL 9005	Size PG	Thread length mm	Height mm	Spanner size mm	Angle size mm	Unit	Net EUR/100 items at a purchase of		
							up to 100	101 - 500	501 - 1000
91447	7	8,5	13,0	15	16,5	100	o. r.	o. r.	o. r.
91448	9	8,5	13,0	19	20,5	100	o. r.	o. r.	o. r.
91449	11	9,0	14,5	24	25,5	100	o. r.	o. r.	o. r.
91450	13,5	9,0	14,5	24	25,5	100	o. r.	o. r.	o. r.
91451	16	10,5	16,0	28	30,5	100	o. r.	o. r.	o. r.
91452	21	11,5	17,5	36	38,0	100	o. r.	o. r.	o. r.
91453	29	11,5	18,0	46	48,0	50	o. r.	o. r.	o. r.
91454	36	13,5	20,0	55	60,0	25	o. r.	o. r.	o. r.
91455	42	13,5	20,0	60	65,0	20	o. r.	o. r.	o. r.
91456	48	14,5	21,0	70	75,0	20	o. r.	o. r.	o. r.

Dimensions and specifications may be changed without prior notice.

o. r. = on request

HELUTOP HT

HSK-PVDF

HELUTOP MS-EP4

KVA-XXL-MS

HELUTOP HT-Clean

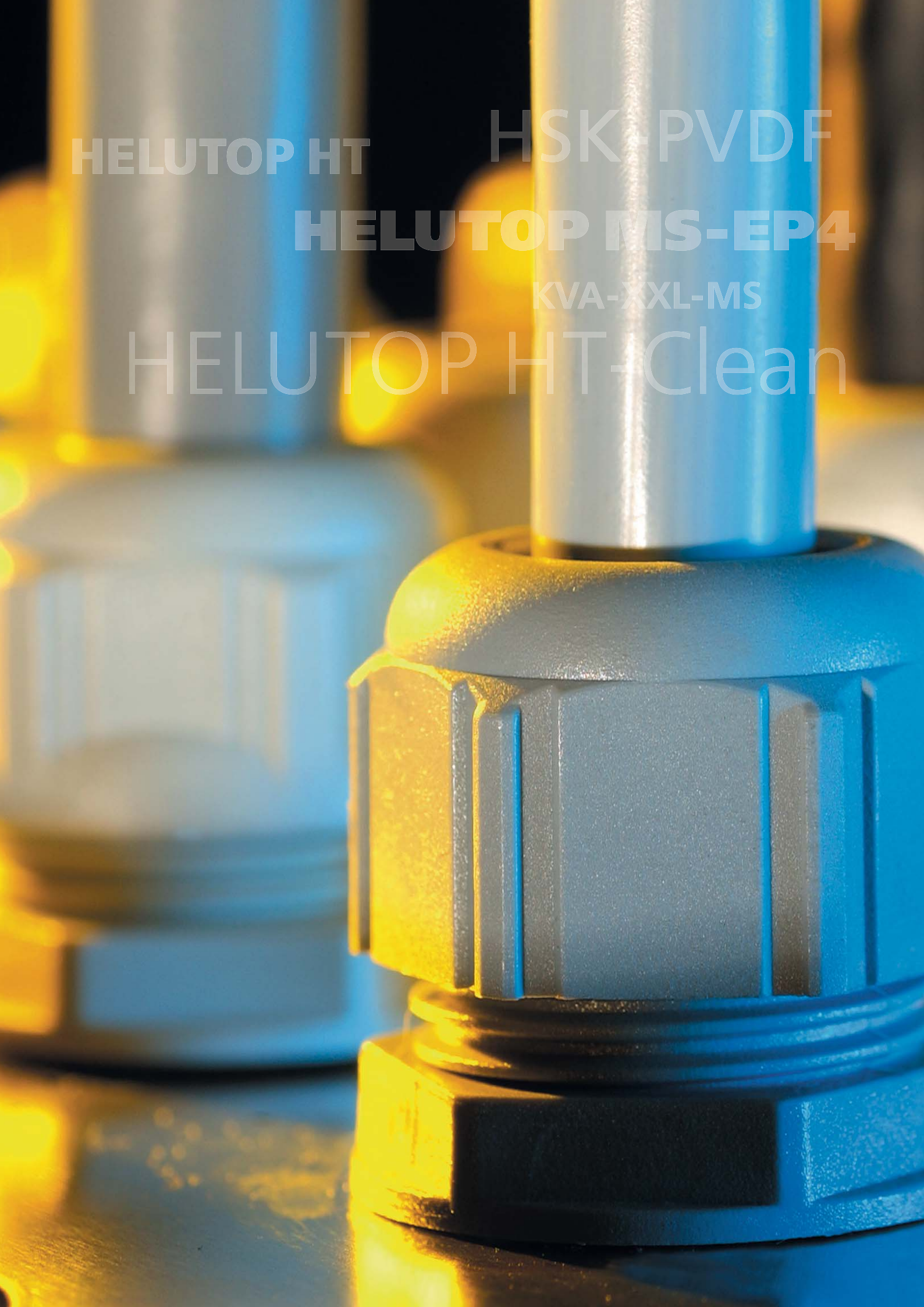



HELUTOP® Easy

Threadless cable gland for easy and quick installation with patented spring/snap system without tools.

Advantages:

- No tools required for installation
- No threaded holes required
- No locknuts required
- Same clamping range as HELUTOP® HT-Series
- VDE-according to DIN EN 62444
- Gland and cable will be fixed with clockwise thread
- Installation in tight areas and no-access spaces (locknut side)
- Cable gland fits as tightly as traditional gland held in place with threaded hole or locknut
- Hexagon of body and cap are same SW
- Large wall thickness range: 0,5 – 4,0 mm
- Quick and easy disassembly with separate tool. No damage to cable gland or wall

Material

PA 6, V2 acc. to UL 94
Seal: Chloroprene-rubber (CR)

Note

Additional colors on request: red RAL 3020, white RAL 9003, blau RAL 5015.
Dimensions borehole $\varnothing = \pm 0.1$

Technical data

Protection class: IP66 / IP68 - 5 bar

Temperature range: -20°C up to +100°C
Temperature range temporary: -30°C up to +150°C

Part no. light grey RAL 7035	Part no. dark grey RAL 7001	Part no. black RAL 9005	ØDrill hole / Metr.	Cable Ø from / to mm	Spanner size mm	Unit	Net EUR/100 items at a purchase of		
							up to 100	101 - 500	501 - 1000
908054	908060	908062	16,3 / M16	5,0 - 10,0	22	50	o. r.	o. r.	o. r.
908055	908061	908063	20,3 / M20	6,0 - 12,0	24	50	o. r.	o. r.	o. r.
908368	908383	908385	25,3 / M25	11,0 - 17,0	29	25	o. r.	o. r.	o. r.
908369	908384	908386	32,3 / M32	15,0 - 21,0	36	25	o. r.	o. r.	o. r.

Disassembly tool

Part no.	Type	Unit	Net EUR/item at a purchase of		
			1	2 - 4	5 - 10
908056	Disassembly tool for Ø16 and Ø20	1	o. r.	o. r.	o. r.
908387	Disassembly tool for Ø25 and Ø32	1	o. r.	o. r.	o. r.

Dimensions and specifications may be changed without prior notice.

o. r. = on request

HELUFAST Threadless cable gland



HELUFAST

Threadless plastic cable gland for easy and quick installation.

Application

- Plant and machine construction
- Automation technology
- Installation technology
- Control cabinet construction

Material

PA 6, V2 acc. to UL 94
Seal: NBR

- halogen-free

Properties

- Quick and simple assembly
- Can be mounted close together
- No locknut required
- Optimum strain relief
- Large clamping areas
- Infinitely applicable for different wall thicknesses

Note

Wall thickness 2,5-4,0 mm.
Color of clamping ring: green

Technical data

Protection class: IP 68 - 5 bar

Temperature range: -20°C up to +100°C

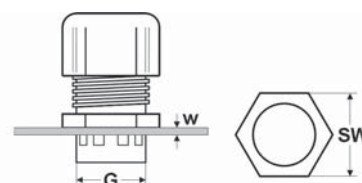

Dimensions

G Size
w Wall thickness
SW Spanner size

Wall thickness range from 1mm to 2,5mm

Part no. light grey RAL 7035	Part no. dark grey RAL 7001	Part no. black RAL 9005	Size Metr.	Cable Ø from / to mm	Spanner size mm	Unit	Net EUR/100 items at a purchase of		
							up to 100	101 - 500	501 - 1000
903120	903140	903130	M12	4,0 - 6,5	15	50	o. r.	o. r.	o. r.
903121	903141	903131	M16	6,0 - 9,5	20	50	o. r.	o. r.	o. r.
903122	903142	903132	M20	7,0 - 12,0	24	50	o. r.	o. r.	o. r.
903123	903143	903133	M25	11,0 - 16,0	28	25	o. r.	o. r.	o. r.
903124	903144	903134	M32	14,0 - 21,0	36	25	o. r.	o. r.	o. r.

Wall thickness range from 2,5mm to 4mm

Part no. light grey RAL 7035	Part no. dark grey RAL 7001	Part no. black RAL 9005	Size Metr.	Cable Ø from / to mm	Spanner size mm	Unit	Net EUR/100 items at a purchase of		
							up to 100	101 - 500	501 - 1000
903125	903145	903135	M12	4,0 - 6,5	15	50	o. r.	o. r.	o. r.
903126	903146	903136	M16	6,0 - 9,5	20	50	o. r.	o. r.	o. r.
903127	903147	903137	M20	7,0 - 12,0	24	50	o. r.	o. r.	o. r.
903128	903148	903138	M25	11,0 - 16,0	28	25	o. r.	o. r.	o. r.
903129	903149	903139	M32	14,0 - 21,0	36	25	o. r.	o. r.	o. r.

Wall thickness range from 1mm to 4mm

Part no. light grey RAL 7035	Part no. dark grey RAL 7001	Part no. black RAL 9005	Size Metr.	Cable Ø from / to mm	Spanner size mm	Unit	Net EUR/100 items at a purchase of		
							up to 100	101 - 500	501 - 1000
900015	904278	904280	M40	19,0 - 27,5	46	10	o. r.	o. r.	o. r.
900016	904279	904281	M50	26,0 - 34,0	55	10	o. r.	o. r.	o. r.

Dimensions and specifications may be changed without prior notice.

o. r. = on request

HELUFAST Circlip pliers



HELUFAST circlip pliers

Pliers for threadless plastic cable gland.
Combined with the correct insert, the pliers can
be used for all HELUFAST cable glands.
The metal plier insert is simple to change by
hand.

Pliers

Part no.	Size	Unit	Net EUR/item at a purchase of		
			1	2 - 5	6 - 10
980000	-	1	o. r.	o. r.	o. r.

Dimensions and specifications may be changed without prior notice.

o. r. = on request

HELUFAST Circlip pliers

Storage battery-hydraulic systems



HELUFAST circlip pliers, storage battery-hydraulic systems

Electro-hydraulic circlip pliers for threadless plastic cable gland.
 Combined with the correct insert, the pliers can be used for all HELUFAST cable glands.
 With rechargeable NIMH battery adjustable compression and automatic return.
 The metal plier insert is simple to change by hand.



Pliers

Part no.	Size	Unit	Net EUR/item at a purchase of		
			1	2 - 5	6 - 10
905332	-	1	o. r.	o. r.	o. r.

Dimensions and specifications may be changed without prior notice.

o. r. = on request

HELUFAST Inserts



HELUFAST Inserts

Inserts for the new, threadless plastic cable gland.

Combined with the correct insert, the pliers can be used for all HELUFAST glands.

The metal plier insert is simple to change by hand.

Inserts

Part no.	Size	Unit	Net EUR/item at a purchase of		
			1	2 - 5	6 - 10
980010	M12 x 1,5	1	o. r.	o. r.	o. r.
980011	M16 x 1,5	1	o. r.	o. r.	o. r.
980012	M20 x 1,5	1	o. r.	o. r.	o. r.
980013	M25 x 1,5	1	o. r.	o. r.	o. r.
980014	M32 x 1,5	1	o. r.	o. r.	o. r.
980015	M40 x 1,5	1	o. r.	o. r.	o. r.
980016	M50 x 1,5	1	o. r.	o. r.	o. r.

Dimensions and specifications may be changed without prior notice.

o. r. = on request

HELUTOP® HT-Clean Stainless steel cable gland



HELUTOP® HT-Clean

Highest requirements to cleanliness and cleaning.

- EHEDG authorized
- ECOLAB certified

Application

- Food industry - milk and meat products
- Packaging of food machines
- Beverage industry
- Pharmaceutical industry
- Clean room technology
- Biotechnology
- Chemical industry

Material

Stainless steel 1.4305 / AISI 303
Strain relief: POM
Grommet: TPE according to
FDA 21 CFR 177.2600

Properties

- The smooth surface prevents to adhere harmful micro organisms
- Easy, fast and less expensive cleaning because of the smooth surface
- Suitable for high pressure steam cleanin
- Resistent against chemical cleaning supplies
- No threads are exposed
- High tightness
- No enter from water and dirt from outside
- Reliable strain relief due to strain relief element separated from grommet

Note

- For tightening from outside use the listed tightening tool
- Assembly with commercial socket wrench
- Delivery including counter nut

Technical data

Protection class: IP 68-5 bar, 30 min.
according to EN 60529;
IP 69K according to DIN 40050-9

Temperature range: -20°C up to +100°C
Temperature range temporary: -40°C up to +150°C

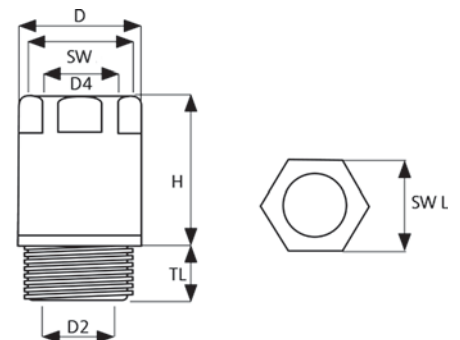

Dimensions

- D Outer diameter of upper part
- D2 Inner diameter of thread
- D4 Inner diameter of upper part
- H Hight without thread
- TL Thread length
- SW Spanner size
- SW L Spanner size Counter nut

HELUTOP® HT-Clean

Part no.	Size Metr.	Cable Ø from / to mm	Thread length mm	Spanner size mm	Outer Ø of upper part mm	Inner Ø of upper part mm	Inner Ø of thread mm	Hight without thread mm	Recommended Cap Counter nut Nm	Unit	Net EUR/100 items
906914	M12 x 1,5	3,0 - 6,5	6,0	14	15,6	6,8	7	21,5	2,5	1	o. r.
906915	M16 x 1,5	5,0 - 10,0	7,0	18	20,2	10,3	10	23	4	1	o. r.
906916	M20 x 1,5	6,0 - 12,0	10,0	22	24,1	12,3	13	27	5	1	o. r.
906917	M25 x 1,5	12,0 - 17,0	14,0	28	30,1	17,3	17	30	6	1	o. r.

Counter nut

Spanner size mm	Hight without thread mm	Recommended Cap Counter nut Nm
15	2,8	6
19	3	9
24	3,5	12
30	4	14

Tightening Tool

Part no.	Size Metr.	Spanner size mm	Height mm	Unit	Net EUR/1 item
906921	M12 x 1,5	5 / 7	5	1	o. r.
906922	M16 x 1,5	6 / 10	5	1	o. r.
906923	M20 x 1,5	8 / 13	8	1	o. r.
906924	M25 x 1,5	10 / 17	8	1	o. r.

Dimensions and specifications may be changed without prior notice.

o. r. = on request



HELUTOP® HT-Clean-EMC

Highest requirements to cleanliness and cleaning.

- EHEDG authorized
- ECOLAB certified

Application

- Food industry - milk and meat products
- Packaging of food machines
- Beverage industry
- Pharmaceutical industry
- Clean room technology
- Biotechnology
- Chemical industry

Material

Stainless steel 1.4305 / AISI 303
Strain relief: POM
Grommet: TPE according to FDA 21 CFR 177.2600

Properties

- The smooth surface prevents to adhere harmful micro organisms
- Easy, fast and less expensive cleaning because of the smooth surface
- Suitable for high pressure steam cleaning
- Resistent against chemical cleaning supplies
- No threads are exposed
- High tightness
- No enter from water and dirt from outside
- Reliable strain relief due to strain relief element separated from grommet

Note

- For tightening from outside use the listed tightening tool
- Assembly with commercial socket wrench
- Delivery including counternut

Technical data

Protection class: IP 68-5 bar, 30 min. according to EN 60529;
IP 69K according to DIN 40050-9

Temperature range: -20°C up to +100°C
Temperature range temporary: -40°C up to +150°C

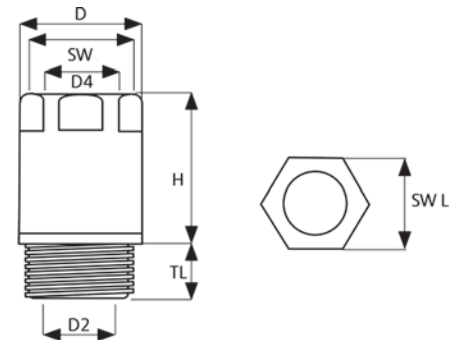

Dimensions

- D Outer diameter of upper part
- D2 Inner diameter of thread
- D4 Inner diameter of upper part
- H Height without thread
- TL Thread length
- SW Spanner size
- SW L Spanner size counter nut

HELUTOP® HT-Clean-EMV (EMC)

Part no.	Size Metr.	Cable Ø from / to mm	Thread length mm	Spanner size mm	Outer Ø of upper part mm	Inner Ø of upper part mm	Inner Ø of thread mm	Height without thread mm	Recommended Cap Counternut Nm	Unit	Net EUR/100 items
906918	M16 x 1,5	5,0 - 10,0	7,0	18	20,2	10,3	10	28,5	4	1	o. r.
906919	M20 x 1,5	6,0 - 12,0	10,0	22	24,1	12,3	13	33	5	1	o. r.
906920	M25 x 1,5	12,0 - 17,0	14,0	28	30,1	17,3	17	38	6	1	o. r.

Counternut Clean-EMV (EMC)

Spanner size mm	Height without thread mm	Recommended Cap Counternut Nm
15	2,8	6
19	3	9
24	3,5	12
30	4	14

Tightening Tool

Part no.	Size Metr.	Spanner size mm	Height mm	Unit	Net EUR/1 item
906921	M12 x 1,5	5 / 7	5	1	o. r.
906922	M16 x 1,5	6 / 10	5	1	o. r.
906923	M20 x 1,5	8 / 13	8	1	o. r.
906924	M25 x 1,5	10 / 17	8	1	o. r.

Dimensions and specifications may be changed without prior notice.

o. r. = on request

HELUTOP® HT-MS Plus Cable gland

For increased strain relief



HELUTOP® HT-MS Plus

Nickel-coated brass cable gland for very high density and strain relief.

Application

- Plant and machine construction
- Automation technology
- Vehicle construction and shipbuilding
- Installation technology
- Control cabinet construction

Material

Brass, nickel plated
Seal: NBR
O-ring: NBR

Properties

- Optimum strain relief through clamping plates (strain relief B to EN 50262 over the entire clamping region)
- Easy to assemble
- Large clamping areas

Note

For rotating the cap nut use tool. Note tightening torque!
Details on the individual tests appear in section "Technical Information".

Technical data

Protection class: IP 68 - 40 bar / IP 69K
Temperature range: -40°C up to +120°C
Test standard: EN50262



Dimensions

G Thread size
GL Thread length
SW Spanner size

Metric thread

Part no.	Size Metr.	Sealing insert colour	Cable Ø from / to mm	Thread length mm	Spanner size mm	Unit	Net EUR/100 items at a purchase of		
							up to 100	101 - 500	501 - 1000
905720	M16 x 1,5	grey	4,0 - 11,0	8,0	21	100	o. r.	o. r.	o. r.
905721	M20 x 1,5	grey	5,0 - 13,0	10,0	24	100	o. r.	o. r.	o. r.
905722	M25 x 1,5	grey	6,5 - 15,5	10,0	28	50	o. r.	o. r.	o. r.
905723	M25 x 1,5	grey	10,0 - 20,0	10,0	30	50	o. r.	o. r.	o. r.

Dimensions and specifications may be changed without prior notice.

o. r. = on request

HELUTOP® HT-MS c Plus Cable gland

For increased strain relief, chromated



HELUTOP® HT-MS c Plus

Black-chromated brass cable gland for very high density and strain relief.

Application

- Plant and machine construction
- Automation technology
- Vehicle construction and shipbuilding
- Installation technology
- Control cabinet construction

Material

Brass
Seal: NBR
O-ring: NBR

Properties

- Optimum strain relief through clamping plates (strain relief B to EN 50262 over the entire clamping region)
- Easy to assemble
- Large clamping areas

Note

For rotating the cap nut use tool. Note tightening torque!
Details on the individual tests appear in section "Technical Information".

Technical data

Protection class: IP 68 - 40 bar / IP 69K

Temperature range: -40°C up to +120°C



Dimensions

G Thread size
GL Thread length
SW Spanner size

Metric thread

Part no.	Size Metr.	Sealing insert colour	Cable Ø from / to mm	Thread length mm	Spanner size mm	Unit	Net EUR/100 items at a purchase of		
							up to 100	101 - 500	501 - 1000
905724	M16 x 1,5	grey	4,0 - 11,0	8,0	21	100	o. r.	o. r.	o. r.
905725	M20 x 1,5	grey	5,0 - 13,0	9,0	24	100	o. r.	o. r.	o. r.
905726	M25 x 1,5	grey	6,5 - 15,5	10,0	28	50	o. r.	o. r.	o. r.
905727	M25 x 1,5	grey	10,0 - 20,0	10,0	30	50	o. r.	o. r.	o. r.

Dimensions and specifications may be changed without prior notice.

o. r. = on request



OF

Open folding profile for simple cable insertion. The profile can be re-opened at any time.

Application

- Plant and machine construction
- Robotics
- Automation technology
- Vehicle construction and shipbuilding
- Railway technology
- Installation technology
- Control cabinet construction

Material

Polyamide
O-ring: NBR

- halogen-free
- phosphor-free
- silicone-free
- cadmium-free

Technical data

Protection class: IP 68

Temperature range: -20°C up to +80°C

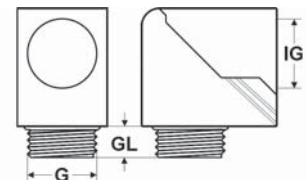

Dimensions

G Thread size outside
GL Thread length
IG Thread size inside

From metric to metric

Part no. light grey RAL 7035	Part no. black RAL 9005	Size Metr.	Thread length mm	Unit	Net EUR/100 items at a purchase of		
					up to 100	101 - 500	501 - 1000
90271	91835	M16 x 1,5	8,0	25	o. r.	o. r.	o. r.
90272	91836	M20 x 1,5	9,0	25	o. r.	o. r.	o. r.
90273	91837	M25 x 1,5	11,0	10	o. r.	o. r.	o. r.

From PG to PG

Part no. light grey RAL 7035	Part no. black RAL 9005	Size PG	Thread length mm	Unit	Net EUR/100 items at a purchase of		
					up to 100	101 - 500	501 - 1000
90383	97110	9	8,0	25	o. r.	o. r.	o. r.
90384	97502	11	8,0	25	o. r.	o. r.	o. r.
90385	97073	13,5	9,0	25	o. r.	o. r.	o. r.
90386	94781	16	10,0	25	o. r.	o. r.	o. r.
90387	94782	21	11,0	25	o. r.	o. r.	o. r.
90388	96102	29	11,0	10	o. r.	o. r.	o. r.

Dimensions and specifications may be changed without prior notice.

o. r. = on request

HSSV-KF Collapsible flange gland



HSSV-KF Collapsible flange gland

Opening flange angle for connection glands or cable glands.

- Flange angle opened to enable simple insertion of pre-assembled cables
- Simple assembly
- Highly stable

Material

Polyamide PA 6

Flammability acc. to UL 94: V0

- halogen-free
- cadmium-free

Properties

Resistant to a multitude of

- Fuels
- Mineral oils
- Greases
- Weak bases
- Weak acids

Note

- UR-tested
- Threaded connection metric to EN 60423

Technical data

Protection class: IP 65

Temperature range: -40°C up to +110°C

Temperature range temporary up to +140°C

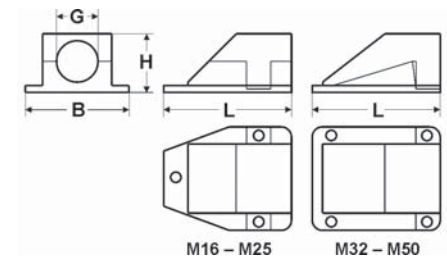

Dimensions

- G Thread size inside
 H Height
 B Width
 L Length

Metric thread - female

Part no. grey	Part no. black	Size metr. inside	Height mm	Width mm	Length mm	Unit	Net EUR/100 items at a purchase of		
							up to 100	101 - 500	501 - 1000
920507	920513	M16 x 1,5	35	47	49	10	o. r.	o. r.	o. r.
920508	920514	M20 x 1,5	35	47	49	10	o. r.	o. r.	o. r.
920509	920515	M25 x 1,5	44	65	69	10	o. r.	o. r.	o. r.
920510	920516	M32 x 1,5	55	78	90	10	o. r.	o. r.	o. r.
920511	920517	M40 x 1,5	66	94	99	10	o. r.	o. r.	o. r.
920512	920518	M50 x 1,5	76	101	116	10	o. r.	o. r.	o. r.

Dimensions and specifications may be changed without prior notice.

o. r. = on request



WV

Profile for simple cable insertion.

Material

Die-cast zinc
O-ring: Chloroprene-rubber (CR)

Technical data

Protection class: IP 65

Temperature range: -20°C up to +100°C

Application

- Plant and machine construction
- Robotics
- Automation technology
- Vehicle construction and shipbuilding
- Railway technology
- Installation technology
- Control cabinet construction

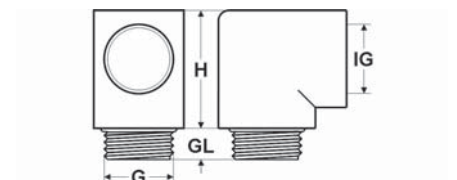

Dimensions

- G Thread size outside
- GL Thread length
- IG Thread size inside
- H Height without thread

From metric to metric

Part no.	Size Metr. outside	Thread length mm	Size Metr. inside	Height mm	Unit	Net EUR/ 100 items at a purchase of		
						up to 100	101 - 500	501 - 1000
98561	M16 x 1,5	7,0	M16 x 1,5	25,0	25	o. r.	o. r.	o. r.
98562	M20 x 1,5	7,0	M20 x 1,5	30,0	25	o. r.	o. r.	o. r.
98563	M25 x 1,5	7,0	M25 x 1,5	35,0	25	o. r.	o. r.	o. r.
98564	M32 x 1,5	10,0	M32 x 1,5	45,0	10	o. r.	o. r.	o. r.

From PG to PG

Part no.	Size PG outside	Thread length mm	Size PG inside	Height mm	Unit	Net EUR/ 100 items at a purchase of		
						up to 100	101 - 500	501 - 1000
99020	9	7,0	9	23,0	25	o. r.	o. r.	o. r.
99021	11	7,0	11	28,0	25	o. r.	o. r.	o. r.
99022	13,5	7,0	13,5	32,0	25	o. r.	o. r.	o. r.
99023	16	7,0	16	27,0	25	o. r.	o. r.	o. r.
99024	21	10,0	21	38,0	10	o. r.	o. r.	o. r.
99025	29	11,0	29	46,0	10	o. r.	o. r.	o. r.

Dimensions and specifications may be changed without prior notice.

o. r. = on request



WVF

Profile for simple cable insertion.

Material

Die-cast zinc
O-ring: Chloroprene-rubber (CR)

Technical data

Protection class: IP 68 - 10 bar

Temperature range: -20°C up to +100°C

Application

- Plant and machine construction
- Robotics
- Automation technology
- Vehicle construction and shipbuilding
- Railway technology
- Installation technology
- Control cabinet construction

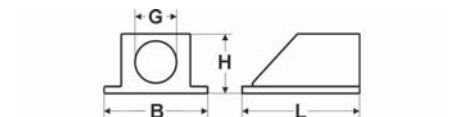

Abmessungen

- G Thread size inside
H Height
B Width
L Length

Metric thread - female

Part no.	Size Metr. innen	Height mm	Width mm	Length mm	Unit	Net EUR/100 items at a purchase of		
						up to 100	101 - 500	501 - 1000
91730	M20 x 1,5	35,0	53,0	56,0	10	o. r.	o. r.	o. r.
91731	M25 x 1,5	42,0	63,0	65,0	10	o. r.	o. r.	o. r.
91732	M32 x 1,5	52,0	70,0	75,0	5	o. r.	o. r.	o. r.
91733	M40 x 1,5	52,0	71,0	75,0	5	o. r.	o. r.	o. r.
91734	M50 x 1,5	69,0	89,0	93,0	2	o. r.	o. r.	o. r.
91735	M63 x 1,5	74,0	96,0	114,0	1	o. r.	o. r.	o. r.

PG thread - female

Part no.	Size PG innen	Height mm	Width mm	Length mm	Unit	Net EUR/100 items at a purchase of		
						up to 100	101 - 500	501 - 1000
92930	9	30,0	45,0	48,0	10	o. r.	o. r.	o. r.
92931	11	30,0	45,0	48,0	10	o. r.	o. r.	o. r.
92932	13,5	35,0	53,0	56,0	10	o. r.	o. r.	o. r.
92933	16	35,0	53,0	56,0	10	o. r.	o. r.	o. r.
92934	21	42,0	63,0	65,0	5	o. r.	o. r.	o. r.
92935	29	52,0	71,0	75,0	5	o. r.	o. r.	o. r.
92936	36	69,0	89,0	94,0	2	o. r.	o. r.	o. r.
92937	42	74,0	96,0	114,0	1	o. r.	o. r.	o. r.
92938	48	74,0	96,0	114,0	1	o. r.	o. r.	o. r.

Dimensions and specifications may be changed without prior notice.

o. r. = on request

BW Fastening elbow

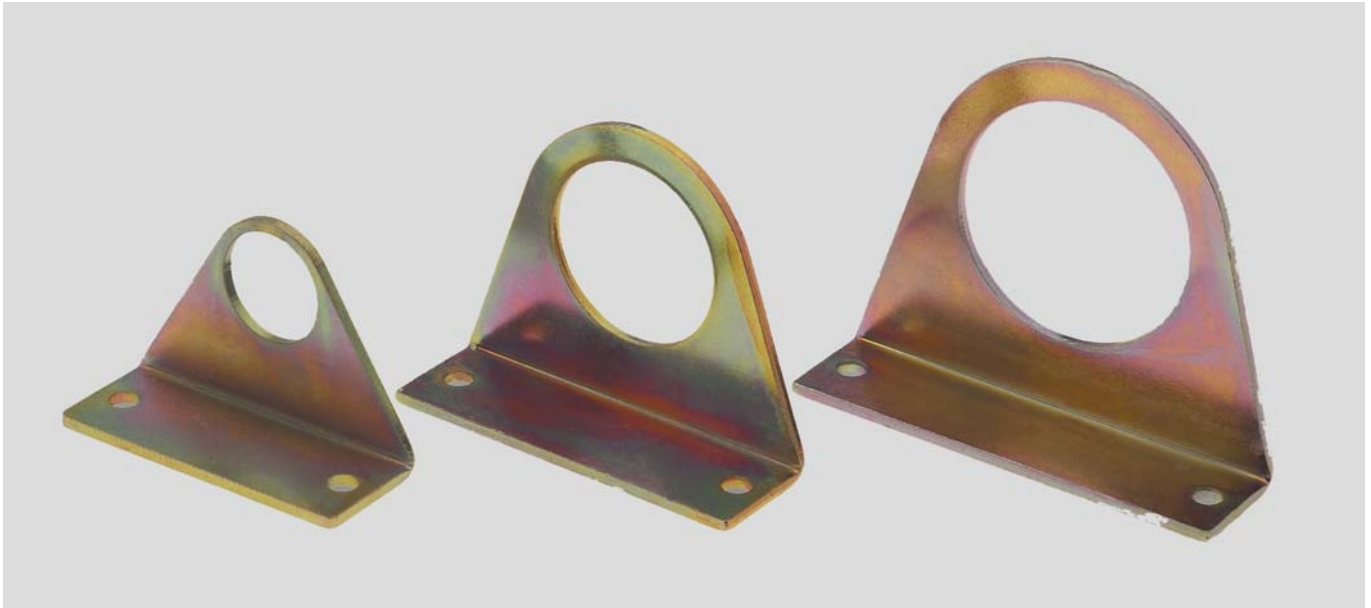

BW

Mounting bracket with penetration and two fastening bores.
For mounting in a door or door elements, as earthing connection and also to equalise potentials in metallic glands.

Application

- Plant and machine construction
- Robotics
- Automation technology
- Vehicle construction and shipbuilding
- Railway technology
- Installation technology
- Control cabinet construction

Material

Steel, chromated yellow

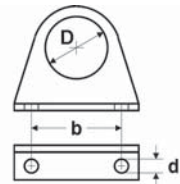

Dimensions

- D Inner diameter
d Boring diameter
b Distance boring (center/center)

Metric thread

Part no.	Size	Inner Ø mm	Boring mm	Boring spacing mm	Unit	Net EUR/100 items at a purchase of		
						up to 100	101 - 500	501 - 1000
93720	M16 x 1,5	17,0	4,5	40	25	o. r.	o. r.	o. r.
93721	M20 x 1,5	21,0	4,5	40	25	o. r.	o. r.	o. r.
93722	M25 x 1,5	26,0	4,5	50	25	o. r.	o. r.	o. r.
93723	M32 x 1,5	33,0	4,5	60	25	o. r.	o. r.	o. r.
93724	M40 x 1,5	41,0	4,5	70	25	o. r.	o. r.	o. r.
93725	M50 x 1,5	51,0	4,5	80	25	o. r.	o. r.	o. r.

PG thread

Part no.	Size	Inner Ø mm	Boring mm	Boring spacing mm	Unit	Net EUR/100 items at a purchase of		
						up to 100	101 - 500	501 - 1000
93715	16	23,0	4,5	40	25	o. r.	o. r.	o. r.
93716	21	29,0	4,5	50	25	o. r.	o. r.	o. r.
93717	29	37,5	4,5	60	25	o. r.	o. r.	o. r.
93718	36	47,5	4,5	70	25	o. r.	o. r.	o. r.
93719	48	60,0	4,5	80	25	o. r.	o. r.	o. r.

Dimensions and specifications may be changed without prior notice.

o. r. = on request



HELUTOP® HT-AIR-PA To prevent water condensation



HELUTOP® HT-AIR-PA

Cable gland with integrated pressure compensation and ventilation system. Prevents water condensation.

Application

- High sealing enclosures
- Environments with extensive temperature ranges

Material

Polyamide PA 6
 Seal: Chloroprene-rubber (CR)
 Flat seal: NBR
 Vent element: PTFE

- phosphor-free
- silicone-free
- cadmium-free

Properties

- A membrane accounts for, that air humidity can leave the enclosure, just at less pressure differences
- Different pressures will reduce water condensation
- No enter from water and dirt from outside
- High strain relief
- Large clamping areas

Technical data

Protection class: IP 66 / IP 67 / IP 69k

Temperature range: -20°C up to +80°C
 Temperature range temporary: -30°C up to +150°C

Test standard: EN 50262, EN 60423 (metric thread)

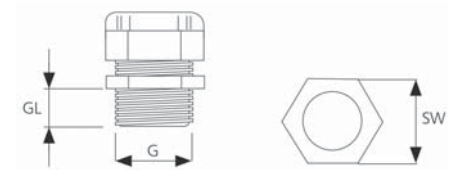

Dimensions

G Thread size
 GL Thread length
 SW Spanner size

Metric thread

Part no. light grey RAL 7035	Size Metr.	Cable Ø from / to mm	Thread length mm	Spanner size mm	Unit	Net EUR/100 items at a purchase of		
						up to 100	101 - 500	501 - 1000
906990	M12 x 1,5	4,0 - 8,0	8,0	19	100	o. r.	o. r.	o. r.
906991	M16 x 1,5	4,0 - 8,0	10,0	19	50	o. r.	o. r.	o. r.
906992	M20 x 1,5	6,0 - 12,0	10,0	24	50	o. r.	o. r.	o. r.

Dimensions and specifications may be changed without prior notice.

o. r. = on request

HELUTOP® HT-AIR-MS To prevent water condensation



HELUTOP® HT-AIR-MS

Cable gland with integrated pressure compensation and ventilation system. Prevents water condensation.

Application

- High sealing enclosures
- Environments with extensive temperature ranges

Material

Brass, nickel plated
 Clamp: Polyamide PA6 - V2
 Seal: Chloroprene-rubber (CR)
 O-ring: NBR
 Flat seal: NBR
 Vent element: PTFE

- phosphor-free
- silicone-free
- cadmium-free

Properties

- A membrane accounts for, that air humidity can leave the enclosure, just at less pressure differences
- Different pressures will reduce water condensation
- No enter from water condensation
- High strain relief
- Large clamping areas

Technical data

Protection class: IP 66 / IP 67 / IP 69k

Temperature range: -20°C up to +80°C
 Temperature range temporary: -30°C up to +150°C

Test standard: EN 50262, EN 60423 (metric thread)

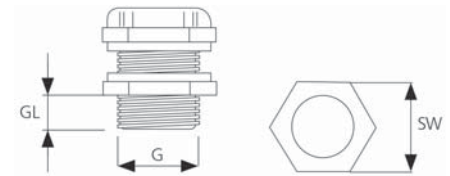

Dimensions

G Thread size
 GL Thread length
 SW Spanner size

Metric thread

Part no.	Size Metr.	Cable Ø from / to mm	Thread length mm	Spanner size mm	Unit	Net EUR/100 items at a purchase of		
						up to 100	101 - 500	501 - 1000
906993	M12 x 1,5	4,0 - 8,0	8,0	17	50	o. r.	o. r.	o. r.
906994	M16 x 1,5	4,0 - 8,0	8,0	17	50	o. r.	o. r.	o. r.
906995	M16 x 1,5	5,0 - 10,0	7,0	20	50	o. r.	o. r.	o. r.
906996	M20 x 1,5	6,0 - 12,0	6,5	22	50	o. r.	o. r.	o. r.

Dimensions and specifications may be changed without prior notice.

o. r. = on request

PBE-K Pressure balance element



PBE-K

Pressure balance element made by polyamide. With semi permeable membrane that allows air flow but blocks moisture.

Application

- Plant and machine construction
- Installation technology
- Control cabinet construction

Material

Polyamide PA 6

Technical data

Protection class: IP 68 / IP 69K

Temperature range: -20°C up to +105°C



Dimensions

G Thread size
GL Thread length
SW Spanner size

Metric thread

Part no. light grey	Part no. black	Size Metr.	Spanner size mm	Thread length mm	Unit	Net EUR/100 items at a purchase of		
						up to 100	101 - 500	501 - 1000
904492	904494	M12 x 1,5	17,0	6,6	100	o. r.	o. r.	o. r.
904493	904495	M12 x 1,5	17,0	10,0	100	o. r.	o. r.	o. r.

Dimensions and specifications may be changed without prior notice.

o. r. = on request

HELUCOND PA6

HSSV-ZE

COV

HSSV IP68

JUMBO

HELUQUICK

■ CABLE PROTECTION TUBE SYSTEMS

Corrugated tubes for standard applications / Corrugated tube connectors / Accessories

Series/Material	Range	Item	Page		
Cable protection tubes					
Polyethylen	for light stress applications	HELUcond PE	192		
Polyamide	for light stress applications	HELUcond PA6-L	193		
	for medium stress applications	HELUcond PA6-S	194		
		HELUcond PA6	195		
	for heavy duty applications	HELUcond PA6 UL	196		
Polypropylen	highly flexible and high load rating	HELUcond PA12	197		
	for medium stress applications	HELUcond PP	198		
Tube connectors					
HELUquick	with plastic male thread	HELUquick straight	199		
		HELUquick elbow 90°	200		
HSSV	with plastic male thread	Overview	201		
		HSSV straight	202		
		HSSV elbow 45°	203		
		HSSV elbow 90°	204		
		with flange	HSSV elbow 90°	205	
			with metal male thread	HSSV straight	206
			HSSV elbow 45°	207	
			HSSV elbow 90°	208	
		with plastic female thread	HSSV straight	209	
		with metal female thread	HSSV straight	210	
		Tube cable gland			
			with plastic male thread	HSSV-ZE	211
with metal male thread	HSSV combination		212		
Tube connectors with increased protection class					
	with plastic male thread	HSSV IP68 straight	213		
	Extenders	HSSV IP68 elbow 90°	214		
Accessories / Parts					
Accessories for series HSSV		HSSV opener	215		
		HSSV outer seal	216		
Folding flange connector		HSSV-KF	217		
Corrugated tube holder		SH, SHV with rotary protection	218		
		SD cover, VS bond bridge, HT hut-rail clip	219		
		UHS with flange pipe holder	220		
Protection tube		Overview	221		

Corrugated tubes in oversize / Corrugated tube connectors

Series/Material	Range	Item	Page
Jumbo assembly instruction			223
Cable protection tubes	Polyamide	JUMBO PA6	224
		JUMBO PA12	225
	Polyurethan	JUMBO PUR	226
Tube connectors		JUMBO-FP straight	227
		JUMBO-WFP elbow 90°	228

Dividable corrugated tubes / Tube connectors / Accessories

Series/Material	Range	Item	Page
Cable protection tubes	Polyamide	HELUcond CO-PA	230
	Polypropylen	HELUcond CO-PP	231
Tube connectors		COV	232
Accessories / Parts	Corrugated tube holder	COS	233
	Cable insertion aid	KE	234

Highly flexible protection tubes

Series/Material	Range	Item	Page
Cable protection tubes			
Plastic with coil springs	Steel spring with PVC jacket	S	236
	Steel spring with PUR jacket	S-PU	237
	Plastic spring with PVC-jacket	K	238
Metal, stripwound	with Agraff profile	M	239
	with hooked profile	SPR-AS	240
	with plastic sheath	SPR-PVC-AS	241
		SPR-PU-AS	242
	with steel wire braiding	SPR-EDU-AS	243
	Stainless steel with Agraff profile	UI	244
Tube connectors			
for plastic cable protection tubes	with high protection	USK	245
	for flexible use	LK-I	247
for metal and plastic protection tubes	with high degree of protection	US	249
	with retaining ring	LI	251
	for stainless steel protection tubes	LT-E-UI straight	253
	with retaining ring	LT-E-UI elbow 90°	254
Accessories / Parts			
Inner sleeve	PVC	EEK	255
Inner sleeve	Stainless steel	EEM	256

Heavy mechanical loads

Series/Material	Range	Item	Page	
Cable protection tubes				
Metal conduits type, plastic-coated	for standard applications	Anaconda Sealtite® EF	258	
	chemical resistance	Anaconda Sealtite® OR	259	
	high temperature	Anaconda Sealtite® HTDL	260	
		Anaconda Sealtite® HC	261	
		Anaconda Sealtite® HCX	262	
	good fire behaviour	Anaconda Sealtite® ZHLS	263	
		Anaconda Sealtite® HFX	264	
	Plastic protection tube		Anaconda Sealtite® CNP	265
		Electromagnetic compatibility (EMC)	Anaconda Sealtite® NMFG-Clean	266
	Tube connectors			
Series CV	for plastic protection tubes	CV Compact tube connector - straight	267	
		CV Compact tube connector - elbow 90°	268	
Series LT	for metal protection tubes	LT straight	269	
		LT elbow 45°	271	
		LT elbow 90°	273	
Series T&B		T&B tube connector straight	275	
		T&B tube connector - elbow 45°	277	
		T&B tube connector elbow 90°	278	
Galvanized steel	for plastic protection tubes	LT-CNP	280	
Stainless steel		LT-CNP-E	281	
		LT-FG-Clean	282	
Accessories / Parts				
Inner sleeve	Galvanized steel	EES	283	



HELUcond PE Corrugated tubes, polyethylene

Weak stress



HELUcond PE-F / PE-B

Cable protection tube for weak stress applications.

Capacity/100mm NW 17: approx. 200 N

Application

- Plant and machine construction
- Automation technology
- Installation technology
- Control cabinet construction

Material

Mod. Polyethylene

Flammability acc. to UL 94: HB

- halogen-free

Properties

- Resistant to bases.

Note

Suitable connection glands:
HELUquick.

Technical data

Temperature range: -40°C up to +70°C

Temperature range temporary up to +90°C

Fine profile / PE-F

Part no. grey	Part no. black	Nominal size mm	Inner Ø mm	Outer Ø mm	Per metres	Net EUR/100 metres at a purchase of		
						up to 100	101 - 500	501 - 1000
91621	90448	10,0	9,8	12,7	50	o. r.	o. r.	o. r.
90433	90449	12,0	11,6	15,6	50	o. r.	o. r.	o. r.
90435	90451	17,0	16,3	20,8	50	o. r.	o. r.	o. r.
90436	90452	23,0	22,9	27,9	50	o. r.	o. r.	o. r.
90437	90453	29,0	28,9	34,0	25	o. r.	o. r.	o. r.
90438	90454	37,0	33,5	41,5	25	o. r.	o. r.	o. r.
90439	90455	50,0	45,2	53,4	25	o. r.	o. r.	o. r.

Coarse profile / PE-B

Part no. grey	Part no. black	Nominal size mm	Inner Ø mm	Outer Ø mm	Per metres	Net EUR/100 metres at a purchase of		
						up to 100	101 - 500	501 - 1000
93781	93786	21,0	21,7	28,0	50	o. r.	o. r.	o. r.
93782	93787	29,0	28,5	34,5	25	o. r.	o. r.	o. r.
93783	93788	36,0	36,0	42,4	25	o. r.	o. r.	o. r.
93784	93789	48,0	47,7	54,5	25	o. r.	o. r.	o. r.

Dimensions and specifications may be changed without prior notice.

o. r. = on request

HELUcond PA6-L Corrugated tubes, polyamide

Weak stress



HELUcond PA6-L

Cable protection tube for weak to medium stress applications.
Capacity/100mm NW 17: approx. 250 N

Application

- Plant and machine construction
- Automation technology
- Vehicle construction and shipbuilding
- Installation technology
- Control cabinet construction

Material

Mod. Polyamide PA 6
Flammability acc. to UL 94: V2

- halogen-free
- phosphor-free

Properties

Resistant to a multitude of

- Fuels
- Mineral oils
- Greases
- Weak bases
- Weak acids

Note

Suitable connection glands:
HELUquick, HSSV.

Technical data

Temperature range: -40°C up to +120°C
Temperature range temporary up to +150°C

Fine profile

Part no. grey	Part no. black	Nominal size mm	Inner Ø mm	Outer Ø mm	Per metres	Net EUR/ 100 metres at a purchase of		
						up to 100	101 - 500	501 - 1000
99610	99620	7,5	6,8	10,0	50	o. r.	o. r.	o. r.
99611	99621	10,0	10,0	12,8	50	o. r.	o. r.	o. r.
99612	99622	12,0	12,5	15,7	50	o. r.	o. r.	o. r.
99613	99623	14,0	14,4	18,5	50	o. r.	o. r.	o. r.
99614	99624	17,0	16,8	21,1	50	o. r.	o. r.	o. r.
99615	99625	23,0	23,4	28,4	50	o. r.	o. r.	o. r.
99616	99626	29,0	29,2	34,5	25	o. r.	o. r.	o. r.
99617	99627	37,0	34,0	41,8	25	o. r.	o. r.	o. r.
99618	99628	50,0	46,0	53,8	25	o. r.	o. r.	o. r.

Dimensions and specifications may be changed without prior notice.

o. r. = on request

HELUcond PA6-S Corrugated tubes, polyamide

Medium stress



HELUcond PA6-S

Cable protection tube for medium to heavy-duty applications.
Capacity/100mm NW 17: approx. 350 N

Application

- Plant and machine construction
- Robotics
- Automation technology
- Vehicle construction and shipbuilding
- Railway technology
- Installation technology
- Control cabinet construction

Material

Mod. Polyamide PA 6
Flammability acc. to UL 94: V2

- halogen-free
- cadmium-free

Properties

Resistant to a multitude of

- Fuels
- Mineral oils
- Greases
- Weak bases
- Weak acids

Note

Suitable connection glands:
HELUquick, HSSV.

Technical data

Temperature range: -40°C up to +120°C
Temperature range temporary up to +150°C

Fine profile

Part no. grey	Part no. black	Nominal size mm	Inner Ø mm	Outer Ø mm	Per metres	Net EUR/ 100 metres at a purchase of		
						up to 100	101 - 500	501 - 1000
920154	920155	4,5	4,5	7,1	100	o. r.	o. r.	o. r.
92724	92723	7,5	6,6	10,0	50	o. r.	o. r.	o. r.
92676	92713	10,0	9,8	12,8	50	o. r.	o. r.	o. r.
92677	92714	12,0	12,3	15,7	50	o. r.	o. r.	o. r.
92678	92715	17,0	16,6	21,1	50	o. r.	o. r.	o. r.
92679	92716	23,0	23,1	28,4	50	o. r.	o. r.	o. r.
92685	92717	29,0	28,9	34,5	25	o. r.	o. r.	o. r.
92686	92718	37,0	34,0	42,2	25	o. r.	o. r.	o. r.
92687	92719	50,0	45,6	53,8	25	o. r.	o. r.	o. r.

Dimensions and specifications may be changed without prior notice.

o. r. = on request

HELUcond PA6 Corrugated tubes, polyamide



Medium stress



HELUcond PA6-F / PA6-B

Cable protection tube for medium to heavy-duty applications.

Capacity/100mm NW 16/17: approx. 350 N

Application

- Plant and machine construction
- Robotics
- Automation technology
- Vehicle construction and shipbuilding
- Railway technology
- Installation technology
- Control cabinet construction

Material

Mod. Polyamide PA 6

Flammability acc. to UL 94: HB

- halogen-free
- cadmium-free

Properties

Resistant to a multitude of

- Fuels
- Mineral oils
- Greases
- Weak bases
- Weak acids

Note

- UL recognized / UR from trade size 16.0

Suitable connection glands:
HELUquick, HSSV.

Technical data

Temperature range: -40°C up to +120°C

Temperature range temporary up to +150°C

Fine profile / PA6-F

Part no. grey	Part no. black	Nominal size mm	Inner Ø mm	Outer Ø mm	Per metres	Net EUR/100 metres at a purchase of		
						up to 100	101 - 500	501 - 1000
92675	96806	7,5	6,7	10,0	50	o. r.	o. r.	o. r.
90440	90456	10,0	9,9	13,0	50	o. r.	o. r.	o. r.
90441	90457	12,0	12,2	15,7	50	o. r.	o. r.	o. r.
90443	90459	17,0	16,6	21,2	50	o. r.	o. r.	o. r.
90444	90460	23,0	23,2	28,3	50	o. r.	o. r.	o. r.
90445	90461	29,0	29,0	34,5	25	o. r.	o. r.	o. r.
90446	90462	37,0	36,0	42,4	25	o. r.	o. r.	o. r.
90447	90463	50,0	48,1	53,8	25	o. r.	o. r.	o. r.

Coarse profile / PA6-B

Part no. grey	Part no. black	Nominal size mm	Inner Ø mm	Outer Ø mm	Per metres	Net EUR/100 metres at a purchase of		
						up to 100	101 - 500	501 - 1000
93790	93795	16,0	15,8	21,0	50	o. r.	o. r.	o. r.
93791	93796	21,0	22,4	28,5	50	o. r.	o. r.	o. r.
93792	93797	29,0	28,5	34,5	25	o. r.	o. r.	o. r.
93793	93798	36,0	36,0	42,5	25	o. r.	o. r.	o. r.
93794	93799	48,0	46,5	54,5	25	o. r.	o. r.	o. r.

Dimensions and specifications may be changed without prior notice.

o. r. = on request

HELUcond PA6-UL Corrugated tubes, polyamide



For heavy duty applications



HELUcond PA6-UL-F/B

Heavy-duty cable protection tube for heavy-duty mechanical applications.
Capacity/100mm NW 16/17: approx. 750 N

Application

- Plant and machine construction
- Robotics
- Automation technology
- Vehicle construction and shipbuilding
- Railway technology
- Installation technology
- Control cabinet construction

Material

Mod. Polyamide PA 6
Flammability acc. to UL 94: V0

- halogen-free
- cadmium-free

Properties

Resistant to a multitude of

- Fuels
- Mineral oils
- Greases
- Weak bases
- Weak acids

Note

- UL recognized / UR from trade size 12,0
- Suitable connection glands:
HELUquick, HSSV.

Technical data

Temperature range: -40°C up to +140°C
Temperature range temporary up to +160°C

Fine profile / PA6-UL-F

Part no. grey	Part no. black	Nominal size mm	Inner Ø mm	Outer Ø mm	Per metres	Net EUR/100 metres at a purchase of		
						up to 100	101 - 500	501 - 1000
920384	920394	7,5	6,4	10,0	50	o. r.	o. r.	o. r.
920385	920395	10,0	9,0	13,0	50	o. r.	o. r.	o. r.
920386	920396	12,0	11,0	15,8	50	o. r.	o. r.	o. r.
920387	920397	17,0	16,6	21,0	50	o. r.	o. r.	o. r.
920388	920398	23,0	21,6	28,5	50	o. r.	o. r.	o. r.

Coarse profile / PA6-UL-B

Part no. grey	Part no. black	Nominal size mm	Inner Ø mm	Outer Ø mm	Per metres	Net EUR/100 metres at a purchase of		
						up to 100	101 - 500	501 - 1000
920389	920399	16,0	15,3	21,0	50	o. r.	o. r.	o. r.
920390	920400	21,0	21,6	28,5	50	o. r.	o. r.	o. r.
920391	920401	29,0	27,5	34,5	25	o. r.	o. r.	o. r.
920392	920402	36,0	35,0	42,5	25	o. r.	o. r.	o. r.
920393	920403	48,0	45,5	54,5	25	o. r.	o. r.	o. r.

Dimensions and specifications may be changed without prior notice.

o. r. = on request

HELUcond PA12 Corrugated tubes, polyamide PA12

High flexible and high load rating



HELUcond PA12-F / PA12-B

Cable protection tube for heavy-duty applications.

Capacity/100mm NW 17: approx. 350 N

Application

- Plant and machine construction
- Robotics
- Automation technology
- Railway technology
- Installation technology

Material

Mod. Polyamide 12

Flammability acc. to UL 94: HB

- halogen-free
- cadmium-free

Properties

Resistant to a multitude of

- Fuels
- Mineral oils
- Greases
- Weak bases
- Weak acids

Note

Suitable connection glands:
HELUquick, HSSV.

Technical data

Temperature range: -50°C up to +120°C

Temperature range temporary up to +150°C

Fine profile / PA12-F

Part no. grey	Part no. black	Nominal size mm	Inner Ø mm	Outer Ø mm	Per metres	Net EUR/100 metres at a purchase of		
						up to 100	101 - 500	501 - 1000
920156	920163	10,0	9,9	13,0	50	o. r.	o. r.	o. r.
920157	920164	12,0	12,2	15,7	50	o. r.	o. r.	o. r.
920158	920165	17,0	16,6	21,2	50	o. r.	o. r.	o. r.

Coarse profile / PA12-B

Part no. grey	Part no. black	Nominal size mm	Inner Ø mm	Outer Ø mm	Per metres	Net EUR/100 metres at a purchase of		
						up to 100	101 - 500	501 - 1000
920159	920166	21,0	22,4	28,3	50	o. r.	o. r.	o. r.
920160	920167	29,0	28,0	34,3	25	o. r.	o. r.	o. r.
920161	920168	36,0	35,5	42,3	25	o. r.	o. r.	o. r.
920162	905796	48,0	46,5	54,2	25	o. r.	o. r.	o. r.

Dimensions and specifications may be changed without prior notice.

o. r. = on request

HELUcond PP Corrugated tubes, polypropylene

Medium stress



HELUcond PP

Cable protection tube for medium stress applications.
Capacity/100mm NW 17: approx. 350 N

Application

- Plant and machine construction
- Automation technology
- Vehicle construction and shipbuilding
- Railway technology
- Installation technology
- Chemical plants
- Heating and air-conditioning technology

Material

Polypropylene
UV-resistant

Flammability acc. to UL 94: HB

- halogen-free
- cadmium-free

Properties

Resistant to a multitude of

- Fuels
- Mineral oils
- Greases
- Weak bases
- Weak acids

Note

Suitable connection glands:
HELUquick, HSSV.

Technical data

Temperature range: -40°C up to +130°C
Temperature range temporary up to +150°C

Fine profile

Part no. black	Nominal size mm	Inner Ø mm	Outer Ø mm	Per metres	Net EUR/ 100 metres at a purchase of		
					up to 100	101 - 500	501 - 1000
920170	7,5	6,7	10,0	100	o. r.	o. r.	o. r.
920171	10,0	9,7	12,8	50	o. r.	o. r.	o. r.
920172	12,0	11,6	15,7	50	o. r.	o. r.	o. r.
920173	14,0	14,1	18,4	50	o. r.	o. r.	o. r.
920174	17,0	16,5	21,0	50	o. r.	o. r.	o. r.
920175	23,0	23,0	28,0	50	o. r.	o. r.	o. r.
920176	29,0	28,8	34,0	50	o. r.	o. r.	o. r.
920177	37,0	33,5	41,6	25	o. r.	o. r.	o. r.
920178	50,0	44,8	53,4	25	o. r.	o. r.	o. r.

Dimensions and specifications may be changed without prior notice.

o. r. = on request

HELUquick Corrugated tubes conduit gland - straight



Plastic male thread



HELUquick gland straight

Quick-insert glands for a reliable, quick connection.
Suitable for parallel-corrugated HELUcond protection tubes.

Material

Polyamide PA 6

- halogen-free
- silicone-free
- cadmium-free

Technical data

Protection class: IP 68

Temperature range: -40°C up to +115°C

Properties

Resistant to a multitude of

- Oil
- Gasoline
- Weak bases
- Weak acids

Note

- UR-tested
- Disassembly without additional opener.
Also available angled (45° and 90°).

Metric thread

Part no. grey	Part no. black	Size Metric	Suitable for ND	Thread length mm	Spanner size mm	Unit	Net EUR/100 items at a purchase of		
							up to 100	101 - 500	501 - 1000
904797	904820	M12 x 1,5	7,5	11,5	16,0	50	o. r.	o. r.	o. r.
904798	904821	M12 x 1,5	10,0	12,0	18,0	50	o. r.	o. r.	o. r.
904799	904822	M16 x 1,5	10,0	11,5	18,0	50	o. r.	o. r.	o. r.
904800	904823	M16 x 1,5	12,0	11,5	21,0	50	o. r.	o. r.	o. r.
904801	904824	M20 x 1,5	12,0	13,0	21,0	50	o. r.	o. r.	o. r.
904802	904825	M20 x 1,5	17,0	13,0	27,0	50	o. r.	o. r.	o. r.
904803	904826	M25 x 1,5	17,0	13,0	27,0	50	o. r.	o. r.	o. r.
904804	904827	M25 x 1,5	23,0	13,0	34,0	25	o. r.	o. r.	o. r.
904861	904828	M32 x 1,5	23,0	15,0	34,0	25	o. r.	o. r.	o. r.
904862	904829	M32 x 1,5	29,0	15,0	40,0	25	o. r.	o. r.	o. r.
904863	904830	M40 x 1,5	29,0	15,0	40,0	25	o. r.	o. r.	o. r.
904864	904831	M40 x 1,5	37,0	17,0	55,0	25	o. r.	o. r.	o. r.
904865	904832	M50 x 1,5	37,0	17,0	60,0	25	o. r.	o. r.	o. r.
904866	904833	M50 x 1,5	50,0	17,0	65,0	10	o. r.	o. r.	o. r.
904867	904834	M63 x 1,5	50,0	17,0	70,0	10	o. r.	o. r.	o. r.

Dimensions and specifications may be changed without prior notice.

o. r. = on request

HELUquick Corrugated tubes conduit gland - elbow 90°



Male thread, plastic



HELUquick gland elbow 90°

Quick-insert glands for a reliable, quick connection.

Suitable for parallel-corrugated HELUcond protection tubes.

Application

- Plant and machine construction
- Robotics
- Automation technology
- Vehicle construction and shipbuilding
- Railway technology
- Installation technology
- Control cabinet construction

Material

Polyamide PA 6

- halogen-free
- silicone-free
- cadmium-free

Properties

Resistant to a multitude of

- Oil
- Gasoline
- Weak bases
- Weak acids

Note

- UR-tested
- Disassembly without additional opener.
Also available straight and angled 45°.

Technical data

Protection class: IP 68

Temperature range: -40°C up to +115°C

Metric thread

Part no. grey	Part no. black	Size Metric	Suitable for ND	Thread length mm	Spanner size mm	Unit	Net EUR/ 100 items at a purchase of		
							up to 100	101 - 500	501 - 1000
904805	904835	M10 x 1,0	7,5	12,0	-	50	o. r.	o. r.	o. r.
904806	904836	M12 x 1,5	10,0	10,0	-	50	o. r.	o. r.	o. r.
904807	904837	M16 x 1,5	10,0	12,0	-	50	o. r.	o. r.	o. r.
904808	904838	M16 x 1,5	12,0	12,0	-	50	o. r.	o. r.	o. r.
904809	904839	M20 x 1,5	12,0	13,0	-	50	o. r.	o. r.	o. r.
904810	904840	M20 x 1,5	17,0	13,0	-	50	o. r.	o. r.	o. r.
904811	904841	M25 x 1,5	17,0	13,0	-	50	o. r.	o. r.	o. r.
904812	904842	M25 x 1,5	23,0	13,0	-	50	o. r.	o. r.	o. r.
904813	904843	M32 x 1,5	23,0	15,0	-	25	o. r.	o. r.	o. r.
904814	904844	M32 x 1,5	29,0	15,0	-	10	o. r.	o. r.	o. r.
904815	904845	M40 x 1,5	29,0	15,0	-	10	o. r.	o. r.	o. r.
904816	904846	M40 x 1,5	37,0	15,0	-	10	o. r.	o. r.	o. r.
904817	904847	M50 x 1,5	37,0	15,5	-	10	o. r.	o. r.	o. r.
904818	904848	M50 x 1,5	50,0	15,0	-	5	o. r.	o. r.	o. r.
904819	904849	M63 x 1,5	50,0	16,0	-	5	o. r.	o. r.	o. r.

Dimensions and specifications may be changed without prior notice.

o. r. = on request

■ HELUKABEL® PROTECTION TUBE SYSTEMS PLASTIC/METAL



HSSV HELUcond Quick Connection



Just insert the tube and you are done

The quick and easy one-hand installation or removal saves time. The corrugated tube will be just inserted into the gland body and the connection is ready. The connection is released by sliding a special opener over the corrugated conduit until the raster unit is pushed outwards from the recesses in the conduit. Pull out the corrugated conduit. This operation is completed manually in just a few minutes.

The BENEFITS of this system

- Captive components from one piece
- Quick and easy single-handed assembly using the connection system
 - even in locations which are difficult to access
- Compact gland design enables adjacent installation
 - extremely high packing density
- Yellow safety opener enables simple disassembly from the front
- Universal gland installation
 - universal gland installation for a number of different corrugated profiles
- Protection classification: IP 65 to IP 68
 - Seating surface in gland (corrugated tube) is cylindrical, improving tightness
- Extremely reliable, especially in the field of robotics
 - vibrations do not cause connection to self-release
 - high extraction forces
 - corrugated conduit can be released only using the yellow safety opener
 - cannot be opened accidentally
 - corrugated conduit can rotate in the gland, thus preventing torsion
- Environmentally-friendly
 - halogen-free polyamide PA 6, combustibility to UL 94:V0
 - Material is UL and CSA listed
 - gland body is 100% recyclable
- Very cost-effective
 - optimum price/performance ratio thanks to one gland providing entire function

HSSV Corrugated tubes conduit gland - straight

Male thread, plastic

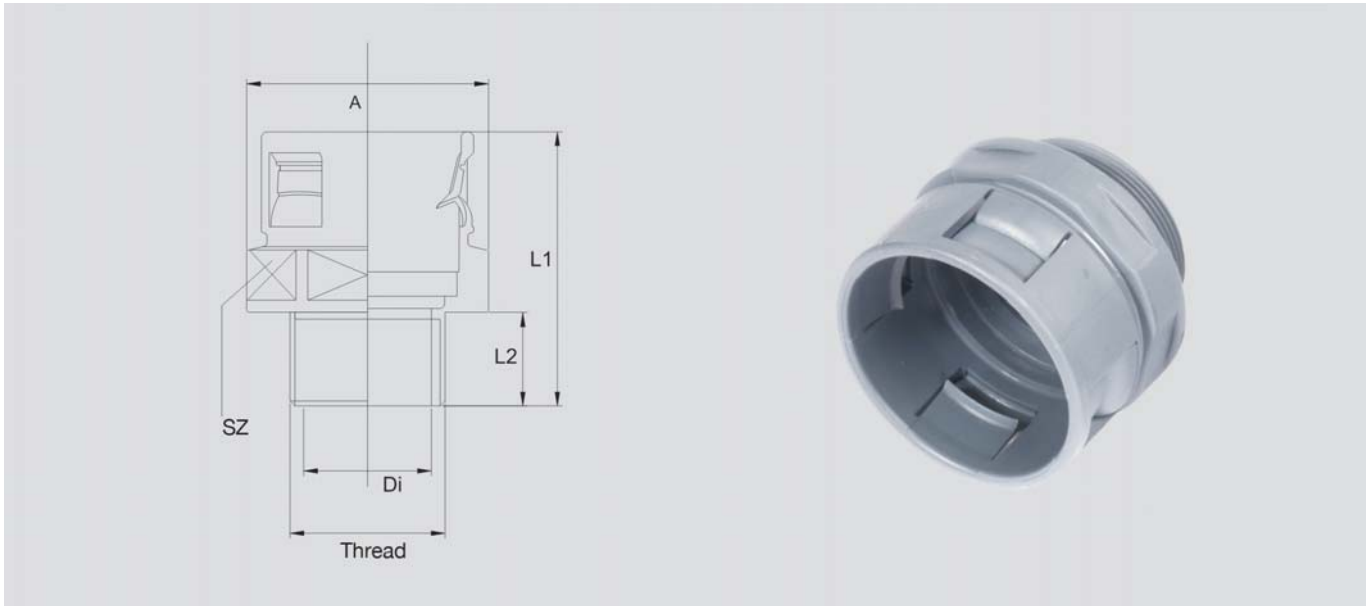

HSSV gland straight

Quick-insert glands for a reliable, quick connection.

Suitable for parallel-corrugated HELUcond protection tubes.

Application

- Plant and machine construction
- Robotics
- Automation technology
- Vehicle construction and shipbuilding
- Railway technology
- Installation technology
- Control cabinet construction

Material

Polyamide PA 6

Flammability acc. to UL 94: V0

- halogen-free
- cadmium-free

Properties

Resistant to a multitude of

- Fuels
- Mineral oils
- Greases
- Weak bases
- Weak acids

Note

- UR-tested
- Protection classification:
- IP 66 with outer seal
- Threaded connection:
Metric to EN 60423
Each unit includes 1 safety opener

Technical data

Protection class: IP 65

Temperature range: -40°C up to +110°C

Metric thread

Part no. grey	Part no. black	Size Metric	Suitable for ND	Thread length mm	Spanner size mm	Unit	Net EUR/ 100 items at a purchase of		
							up to 100	101 - 500	501 - 1000
905858	905859	M10 x 1,0	7,5	8,5	14,0	50	o. r.	o. r.	o. r.
94180	94190	M12 x 1,5	10,0	8,9	19,0	50	o. r.	o. r.	o. r.
920183	920184	M16 x 1,5	10,0	9,3	19,0	50	o. r.	o. r.	o. r.
94181	94191	M16 x 1,5	12,0	8,6	21,0	50	o. r.	o. r.	o. r.
94182	94192	M20 x 1,5	16,0 / 17,0	13,0	27,0	50	o. r.	o. r.	o. r.
94183	94193	M25 x 1,5	21,0 / 23,0	14,3	36,0	50	o. r.	o. r.	o. r.
94184	94194	M32 x 1,5	29,0	14,2	40,0	25	o. r.	o. r.	o. r.
94185	94195	M40 x 1,5	36,0 / 37,0	15,0	50,0	25	o. r.	o. r.	o. r.
94186	94196	M50 x 1,5	48,0 / 50,0	15,5	65,0	10	o. r.	o. r.	o. r.
920185	920186	M63 x 1,5	48,0 / 50,0	15,5	65,0	10	o. r.	o. r.	o. r.

PG thread

Part no. grey	Part no. black	Size PG	Suitable for ND	Thread length mm	Spanner size mm	Unit	Net EUR/ 100 items at a purchase of		
							up to 100	101 - 500	501 - 1000
90480	90490	7	7,5	7,0	14,0	50	o. r.	o. r.	o. r.
90481	90491	9	10,0	7,6	19,0	50	o. r.	o. r.	o. r.
90482	90492	11	12,0	8,5	21,0	50	o. r.	o. r.	o. r.
90483	90493	13,5	16,0 / 17,0	9,8	27,0	50	o. r.	o. r.	o. r.
90484	90494	16	16,0 / 17,0	9,9	27,0	50	o. r.	o. r.	o. r.
90485	90495	21	21,0 / 23,0	11,7	36,0	50	o. r.	o. r.	o. r.
90486	90496	29	29,0	11,7	40,0	25	o. r.	o. r.	o. r.
90487	90497	36	36,0 / 37,0	15,0	50,0	25	o. r.	o. r.	o. r.
90488	90498	48	48,0 / 50,0	15,0	65,0	10	o. r.	o. r.	o. r.

Dimensions and specifications may be changed without prior notice.

o. r. = on request

HSSV Corrugated tubes conduit gland - elbow 45°

Male thread, plastic

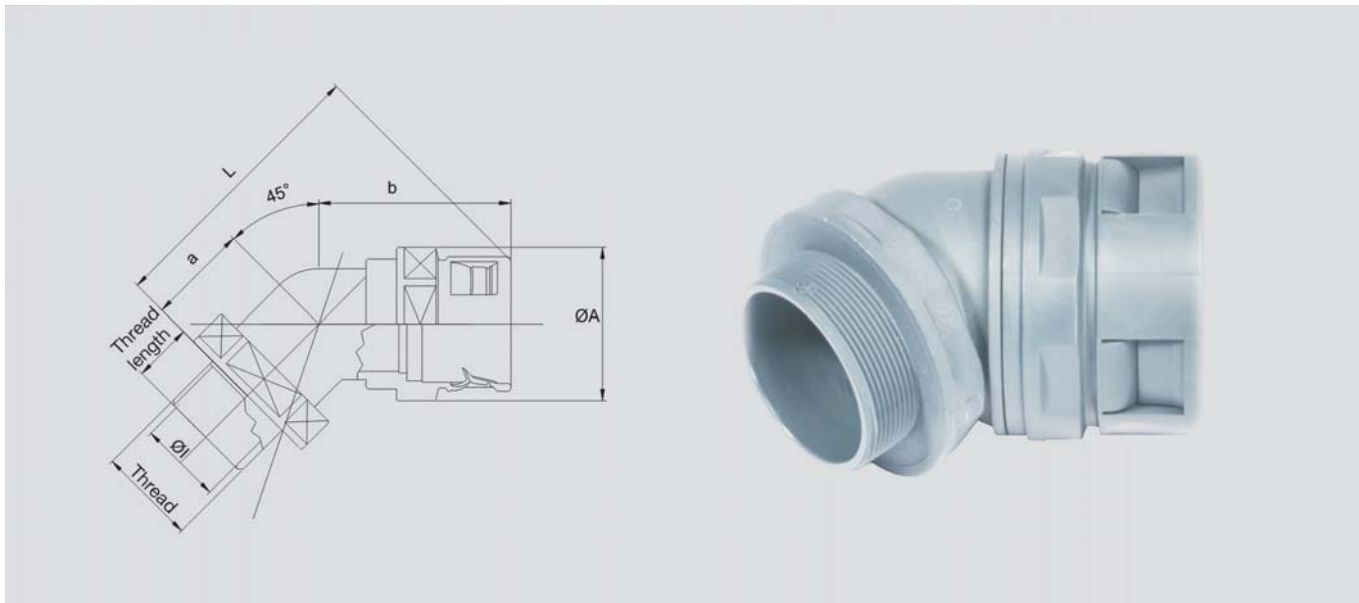

HSSV gland 45°

Quick-insert glands for a reliable, quick connection.
Suitable for parallel-corrugated HELUcond protection tubes.

Application

- Plant and machine construction
- Robotics
- Automation technology
- Vehicle construction and shipbuilding
- Railway technology
- Installation technology
- Control cabinet construction

Material

Polyamide PA 6

- halogen-free
- cadmium-free

Properties

Resistant to a multitude of

- Fuels
- Mineral oils
- Greases
- Weak bases
- Weak acids

Note

- UR-tested
- Protection classification:
• IP 66 with outer seal
- Threaded connection:
Metric to EN 60423
- Each unit includes 1 safety opener.
With PG thread on request.

Technical data

Protection class: IP 65

Temperature range: -40°C up to +110°C

Metric thread

Part no. grey	Part no. black	Size Metric	Suitable for ND	Thread length mm	Unit	Net EUR/100 items at a purchase of		
						up to 100	101 - 500	501 - 1000
920196	920204	M25 x 1,5	21,0 / 23,0	15,5	50	o. r.	o. r.	o. r.
920197	920205	M32 x 1,5	29,0	13,6	25	o. r.	o. r.	o. r.
920198	920206	M40 x 1,5	36,0 / 37,0	15,8	25	o. r.	o. r.	o. r.
920199	920207	M50 x 1,5	48,0 / 50,0	16,3	10	o. r.	o. r.	o. r.
920200	920208	M63 x 1,5	48,0 / 50,0	15,4	5	o. r.	o. r.	o. r.

Dimensions and specifications may be changed without prior notice.

o. r. = on request

HSSV Corrugated tubes conduit gland - elbow 90°

Plastic male thread

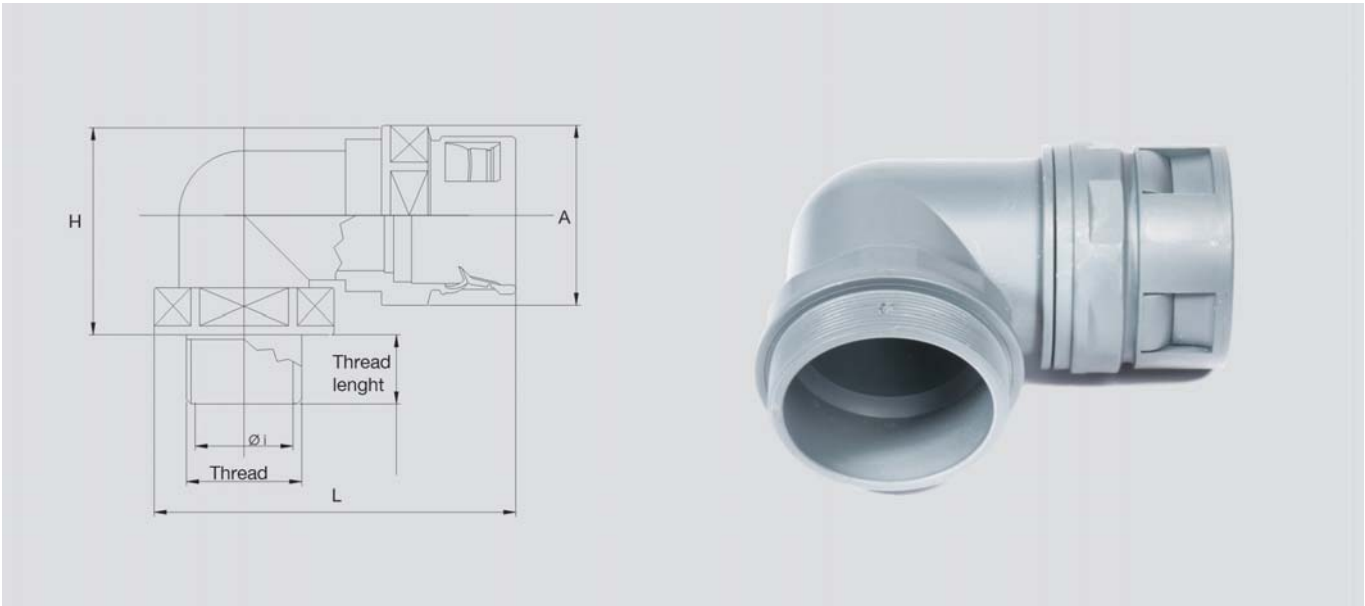

HSSV gland 90°

Quick-insert glands for a reliable, quick connection.

Suitable for parallel-corrugated HELUcond protection tubes.

Application

- Plant and machine construction
- Robotics
- Vehicle construction and shipbuilding
- Railway technology
- Installation technology
- Control cabinet construction

Material

Polyamide PA 6

Flammability acc. to UL 94: V0

- halogen-free
- cadmium-free

Properties

Resistant to a multitude of

- Fuels
- Mineral oils
- Greases
- Weak bases
- Weak acids

Note

- UR-tested
- Protection classification:
- IP 66 with outer seal
- Threaded connection:
Metric to EN 60423
Each unit includes 1 safety opener.

Technical data

Protection class: IP 65

Temperature range: -40°C up to +110°C

Metric thread

Part no. grey	Part no. black	Size Metric	Suitable for ND	Thread length mm	Spanner size mm	Unit	Net EUR/100 items at a purchase of		
							up to 100	101 - 500	501 - 1000
94200	94210	M12 x 1,5	10,0	9,5	-	50	o. r.	o. r.	o. r.
98983	920190	M16 x 1,5	10,0	9,0	-	50	o. r.	o. r.	o. r.
94201	94211	M16 x 1,5	12,0	8,0	-	50	o. r.	o. r.	o. r.
94202	94212	M20 x 1,5	16,0 / 17,0	10,5	-	50	o. r.	o. r.	o. r.
94203	94213	M25 x 1,5	21,0 / 23,0	14,8	-	50	o. r.	o. r.	o. r.
94204	94214	M32 x 1,5	29,0	13,8	-	25	o. r.	o. r.	o. r.
94205	94215	M40 x 1,5	36,0 / 37,0	15,6	-	25	o. r.	o. r.	o. r.
94206	94216	M50 x 1,5	48,0 / 50,0	16,0	-	10	o. r.	o. r.	o. r.
920191	920192	M63 x 1,5	48,0 / 50,0	15,5	-	5	o. r.	o. r.	o. r.

PG thread

Part no. grey	Part no. black	Size PG	Suitable for ND	Thread length mm	Spanner size mm	Unit	Net EUR/100 items at a purchase of		
							up to 100	101 - 500	501 - 1000
98440	98363	9	10,0	9,0	-	50	o. r.	o. r.	o. r.
98441	97382	11	12,0	7,7	-	50	o. r.	o. r.	o. r.
98442	98435	13,5	16,0 / 17,0	10,0	-	50	o. r.	o. r.	o. r.
98443	97944	16	16,0 / 17,0	10,0	-	50	o. r.	o. r.	o. r.
98444	98436	21	21,0 / 23,0	11,8	-	50	o. r.	o. r.	o. r.
98445	98437	29	29,0	11,5	-	25	o. r.	o. r.	o. r.
98446	98438	36	36,0 / 37,0	15,5	-	25	o. r.	o. r.	o. r.
98447	98439	48	48,0 / 50,0	16,0	-	10	o. r.	o. r.	o. r.

Dimensions and specifications may be changed without prior notice.

o. r. = on request

HSSV Corrugated tubes conduit gland - elbow 90°

Flange



HSSV gland 90° flange

Quick-insert glands for a reliable, quick connection.
Suitable for parallel-corrugated HELUcond protection.

Application

- Plant and machine construction
- Robotics
- Automation technology
- Vehicle construction and shipbuilding
- Railway technology
- Installation technology
- Control cabinet construction

Material

Polyamide PA 6

Flammability acc. to UL 94: V0 tubes.

- halogen-free
- cadmium-free

Properties

Resistant to a multitude of

- Fuels
- Mineral oils
- Greases
- Weak bases
- Weak acids

Note

- UR-tested
- Protection classification:
- IP 66 with outer seal
- Each unit includes 1 safety opener

Technical data

Protection class: IP 65

Temperature range: -40°C up to +110°C

Flange

Part no. grey	Part no. black	Suitable for ND	Unit	Net EUR/100 items at a purchase of		
				up to 100	101 - 500	501 - 1000
920209	920214	17,0	50	o. r.	o. r.	o. r.
920210	920215	21,0 / 23,0	50	o. r.	o. r.	o. r.
920211	920216	29,0	25	o. r.	o. r.	o. r.
920212	920217	36,0 / 37,0	25	o. r.	o. r.	o. r.
920213	920218	48,0 / 50,0	10	o. r.	o. r.	o. r.

Dimensions and specifications may be changed without prior notice.

o. r. = on request

HSSV Corrugated tubes conduit gland - straight

Metal male thread

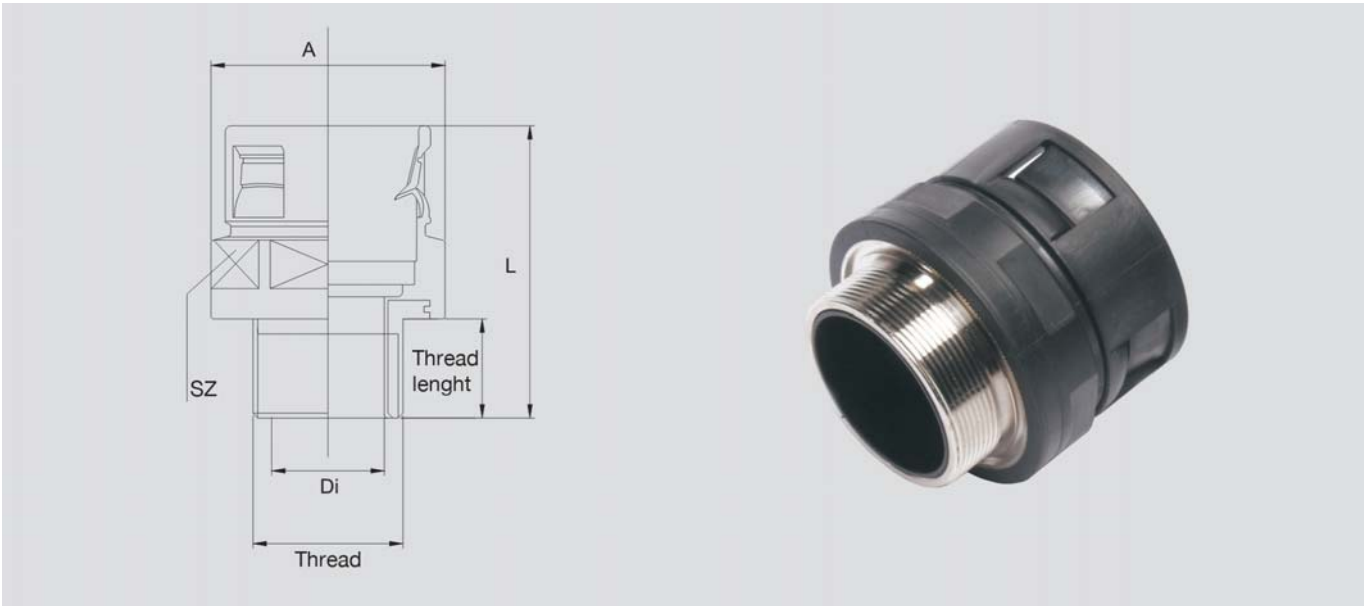

HSSV gland straight

Quick-insert glands with metallic male thread for a reliable, quick connection. Suitable for parallel-corrugated HELUcond protection tubes.

Application

- Plant and machine construction
- Robotics
- Automation technology
- Vehicle construction and shipbuilding
- Railway technology
- Installation technology
- Control cabinet construction

Material

Polyamide PA 6

Flammability acc. to UL 94: V0

- halogen-free
- cadmium-free

Properties

Resistant to a multitude of

- Fuels
- Mineral oils
- Greases
- Weak bases
- Weak acids

Note

Protection classification:

- IP 66 with outer seal

Threaded connection:

Metric to EN 60423

Each unit includes 1 safety opener

Technical data

Protection class: IP 65

Temperature range: -40°C up to +110°C

Metric thread

Part no. grey	Part no. black	Size Metric	Suitable for ND	Thread length mm	Spanner size mm	Unit	Net EUR/100 items at a purchase of		
							up to 100	101 - 500	501 - 1000
920229	920238	M12 x 1,5	10,0	10,0	19,0	50	o. r.	o. r.	o. r.
920230	920239	M16 x 1,5	10,0	10,5	19,0	50	o. r.	o. r.	o. r.
920231	920240	M16 x 1,5	12,0	10,5	21,0	50	o. r.	o. r.	o. r.
920232	920241	M20 x 1,5	16,0 / 17,0	12,0	27,0	50	o. r.	o. r.	o. r.
920233	920242	M25 x 1,5	21,0 / 23,0	15,0	36,0	50	o. r.	o. r.	o. r.
920234	920243	M32 x 1,5	29,0	15,0	40,0	25	o. r.	o. r.	o. r.
920235	920244	M40 x 1,5	36,0 / 37,0	16,0	50,0	25	o. r.	o. r.	o. r.
920236	920245	M50 x 1,5	48,0 / 50,0	16,0	65,0	10	o. r.	o. r.	o. r.

Dimensions and specifications may be changed without prior notice.

o. r. = on request

HSSV Corrugated tubes conduit gland - elbow 45°

Metal male thread



HSSV gland 45°

Quick-insert glands with metallic male thread for a reliable, quick connection. Suitable for parallel-corrugated HELUcond protection tubes.

Application

- Plant and machine construction
- Robotics
- Automation technology
- Vehicle construction and shipbuilding
- Railway technology
- Installation technology
- Control cabinet construction

Material

Polyamide PA 6

- halogen-free

Properties

Resistant to a multitude of

- Fuels
- Mineral oils
- Greases
- Weak bases
- Weak acids

Note

- UR-tested
- Protection classification:
- IP 66 with outer seal
- Threaded connection:
- Metric to EN 60423
- Each unit includes 1 safety opener

Technical data

Protection class: IP 65

Temperature range: -40°C up to +110°C

Metric thread

Part no. grey	Part no. black	Size Metric	Suitable for ND	Thread length mm	Unit	Net EUR/ 100 items at a purchase of		
						up to 100	101 - 500	501 - 1000
920265	920269	M25 x 1,5	21,0 / 23,0	15,0	50	o. r.	o. r.	o. r.
920266	920270	M32 x 1,5	29,0	15,0	25	o. r.	o. r.	o. r.
920267	920271	M40 x 1,5	36,0 / 37,0	16,0	25	o. r.	o. r.	o. r.
920268	920272	M50 x 1,5	48,0 / 50,0	16,0	10	o. r.	o. r.	o. r.

Dimensions and specifications may be changed without prior notice.

o. r. = on request

HSSV Corrugated tubes conduit gland - elbow 90°

Metal male thread



HSSV gland 90° with metallic male thread

Quick-insert glands with metallic male thread for a reliable, quick connection. Suitable for parallel-corrugated HELUcond protection tubes.

Application

- Plant and machine construction
- Robotics
- Automation technology
- Vehicle construction and shipbuilding
- Railway technology
- Installation technology
- Control cabinet construction

Material

Polyamide PA 6

Flammability acc. to UL 94: V0

- halogen-free

Properties

Resistant to a multitude of

- Fuels
- Mineral oils
- Greases
- Weak bases
- Weak acids

Note

- UR-tested
- Protection classification:
- IP 66 with outer seal
- Threaded connection:
- Metric to EN 60423
- Each unit includes 1 safety opener.

Technical data

Protection class: IP 65

Temperature range: -40°C up to +110°C

Metric thread

Part no. grey	Part no. black	Size Metric	Suitable for ND	Thread length mm	Unit	Net EUR/100 items at a purchase of		
						up to 100	101 - 500	501 - 1000
920247	920256	M12 x 1,5	10,0	10,0	50	o. r.	o. r.	o. r.
920248	920257	M16 x 1,5	10,0	10,5	50	o. r.	o. r.	o. r.
920249	920258	M16 x 1,5	12,0	10,5	50	o. r.	o. r.	o. r.
920250	920259	M20 x 1,5	17,0	12,0	50	o. r.	o. r.	o. r.
920251	920260	M25 x 1,5	21,0 / 23,0	15,0	50	o. r.	o. r.	o. r.
920252	920261	M32 x 1,5	29,0	15,0	25	o. r.	o. r.	o. r.
920253	920262	M40 x 1,5	36,0 / 37,0	16,0	25	o. r.	o. r.	o. r.
920254	920263	M50 x 1,5	48,0 / 50,0	16,0	10	o. r.	o. r.	o. r.
920255	920264	M63 x 1,5	48,0 / 50,0	16,0	10	o. r.	o. r.	o. r.

Dimensions and specifications may be changed without prior notice.

o. r. = on request

HSSV Corrugated tubes conduit gland - straight

Plastic female thread

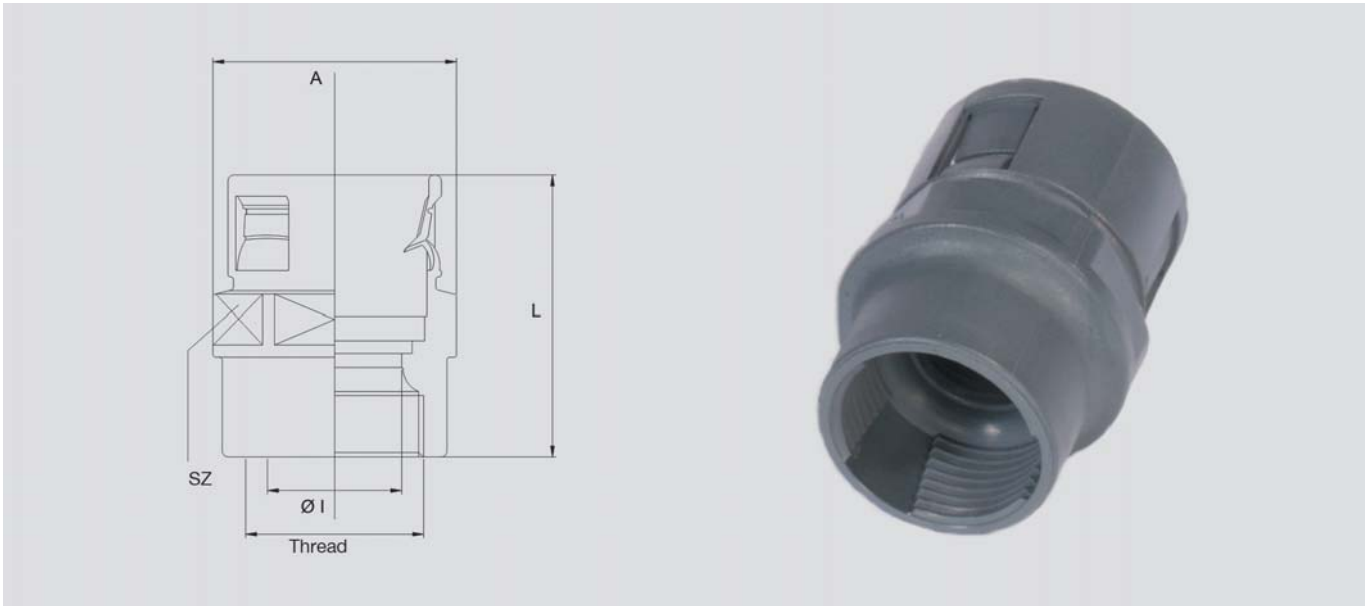

HSSV gland straight

Quick-insert glands for a reliable, quick connection.

Suitable for parallel-corrugated HELUcond protection.

Application

- Plant and machine construction
- Robotics
- Automation technology
- Vehicle construction and shipbuilding
- Railway technology
- Installation technology
- Control cabinet construction

Material

Polyamide PA 6

Flammability acc. to UL 94: V0 tubes.

- halogen-free
- cadmium-free

Properties

Resistant to a multitude of

- Fuels
- Mineral oils
- Greases
- Weak bases
- Weak acids

Note

Protection classification:

- IP 66 with outer seal

Threaded connection:

Metric to EN 60423

Each unit includes 1 safety opener

Technical data

Protection class: IP 65

Temperature range: -40°C up to +110°C

Metric thread

Part no. grey	Part no. black	Size Metric	Suitable for ND	Thread length mm	Spanner size mm	Unit	Net EUR/100 items at a purchase of		
							up to 100	101 - 500	501 - 1000
920220	920225	M16 x 1,5	12,0	10,5	21,0	50	o. r.	o. r.	o. r.
920221	920226	M20 x 1,5	17,0	12,6	27,0	50	o. r.	o. r.	o. r.
920222	920227	M25 x 1,5	23,0	12,6	36,0	50	o. r.	o. r.	o. r.
920223	920228	M32 x 1,5	29,0	12,0	40,0 / 34,5	25	o. r.	o. r.	o. r.

PG female thread

Part no. grey	Part no. black	Size PG	Suitable for ND	Thread length mm	Spanner size mm	Unit	Net EUR/100 items at a purchase of		
							up to 100	101 - 500	501 - 1000
94220	94230	9	10,0	10,2	19,0	50	o. r.	o. r.	o. r.
94221	94231	11	12,0	10,5	21,0	50	o. r.	o. r.	o. r.
94222	94232	13,5	17,0	11,0	27,0	50	o. r.	o. r.	o. r.
94223	94233	16	17,0	10,2	27,0	50	o. r.	o. r.	o. r.
94224	94234	21	23,0	13,5	36,0	50	o. r.	o. r.	o. r.
94225	94235	29	29,0	12,2	40,0	25	o. r.	o. r.	o. r.

Dimensions and specifications may be changed without prior notice.

o. r. = on request

HSSV Corrugated tubes conduit gland - straight

Metal female thread

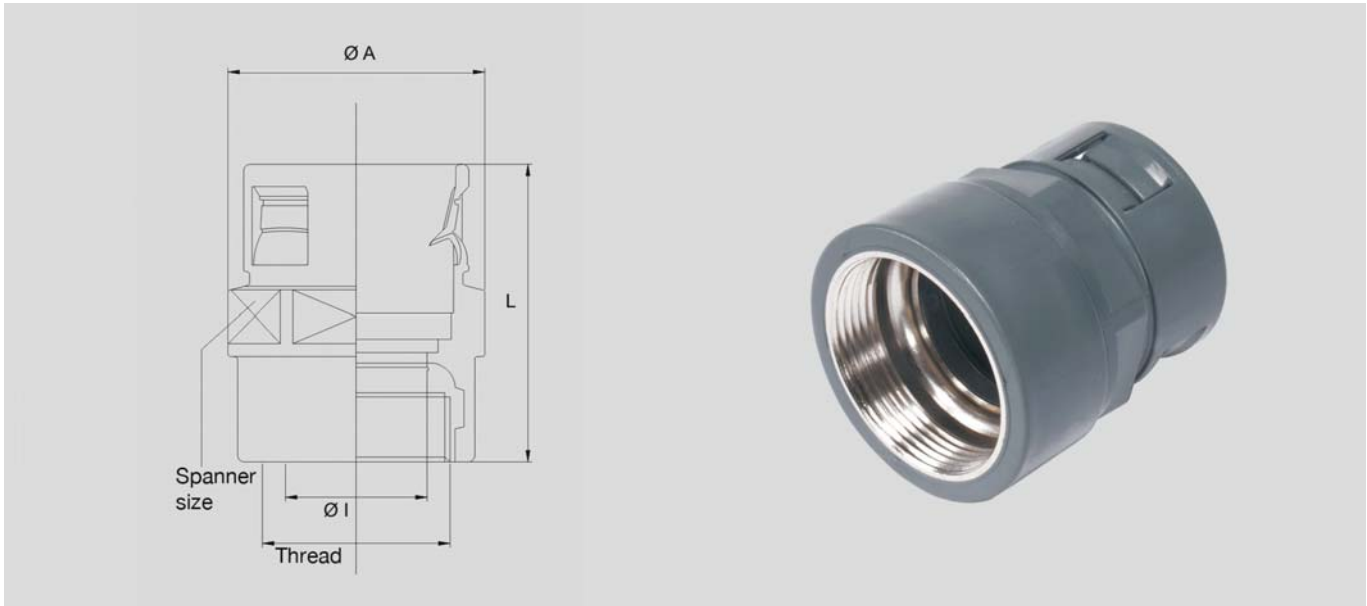

HSSV gland straight

Quick-insert glands with metallic female thread for a reliable, quick connection. Suitable for parallel-corrugated HELUcond protection.

Application

- Plant and machine construction
- Robotics
- Automation technology
- Vehicle construction and shipbuilding
- Railway technology
- Installation technology
- Control cabinet construction

Material

Polyamide PA 6

Flammability acc. to UL 94: V0 tubes.

- halogen-free
- cadmium-free

Properties

Resistant to a multitude of

- Fuels
- Mineral oils
- Greases
- Weak bases
- Weak acids

Note

Protection classification:

- IP 66 with outer seal

Threaded connection:

Metric to EN 60423

Each unit includes 1 safety opener

Technical data

Protection class: IP 65

Temperature range: -40°C up to +110°C

Metric female thread

Part no. grey	Part no. black	Size Metric	Suitable for ND	Thread length mm	Spanner size mm	Unit	Net EUR/100 items at a purchase of		
							up to 100	101 - 500	501 - 1000
920273	920281	M12 x 1,5	10,0	8,0	19,0	50	o. r.	o. r.	o. r.
920274	920282	M16 x 1,5	10,0	9,0	19,0	50	o. r.	o. r.	o. r.
920275	920283	M16 x 1,5	12,0	9,0	21,0	50	o. r.	o. r.	o. r.
920276	920284	M20 x 1,5	16,0 / 17,0	11,0	27,0	50	o. r.	o. r.	o. r.
920277	920285	M25 x 1,5	21,0 / 23,0	11,5	36,0	50	o. r.	o. r.	o. r.
920278	920286	M32 x 1,5	29,0	11,5	40,0	25	o. r.	o. r.	o. r.
920279	920287	M40 x 1,5	36,0 / 37,0	13,0	50,0	25	o. r.	o. r.	o. r.
920280	920288	M50 x 1,5	48,0 / 50,0	14,0	65,0	10	o. r.	o. r.	o. r.

Dimensions and specifications may be changed without prior notice.

o. r. = on request

HSSV-ZE Corrugated tubes cable gland with strain relief

Plastic male thread



Conduit gland HSSV with strain relief

Combined quick-insert cable glands for a reliable, quick connection. Suitable for parallel-corrugated HELUcond protection tubes.

Application

- Plant and machine construction
- Robotics
- Automation technology
- Vehicle construction and shipbuilding
- Railway technology
- Installation technology
- Control cabinet construction

Material

Polyamide PA 6

- halogen-free
- cadmium-free

Properties

Resistant to a multitude of

- Fuels
- Mineral oils
- Greases
- Weak bases
- Weak acids

Note

Threaded connection:
metric to EN 60423
Each unit includes 1 safety opener

Technical data

Protection class by tube: IP 65

Temperature range: -25°C up to +100°C

Metric thread

Part no. grey	Part no. black	Size	Suitable for tube ND	Thread length mm	Unit	Net EUR/100 items at a purchase of		
						up to 100	101 - 500	501 - 1000
903459	903466	M16 x 1,5	10,0	7,5	50	o. r.	o. r.	o. r.
903460	903467	M16 x 1,5	12,0	7,5	50	o. r.	o. r.	o. r.
903461	903468	M20 x 1,5	17,0	8,5	50	o. r.	o. r.	o. r.
903462	903469	M25 x 1,5	23,0	10,5	50	o. r.	o. r.	o. r.
903463	903470	M32 x 1,5	29,0	10,5	25	o. r.	o. r.	o. r.

Dimensions and specifications may be changed without prior notice.

o. r. = on request

HSSV combination Corrugated tubes cable gland



Conduit gland HSSV, combined

Combined with brass cable gland.
Combined quick-insert cable glands with single sealing insert for a reliable, quick connection.
Suitable for parallel-corrugated HELUcond protection tubes.

Application

- Plant and machine construction
- Robotics
- Automation technology
- Vehicle construction and shipbuilding
- Railway technology
- Installation technology
- Control cabinet construction

Material

Flammability acc. to UL 94: V0

- halogen-free
- cadmium-free

Properties

Resistant to a multitude of

- Fuels
- Mineral oils
- Greases
- Weak bases
- Weak acids

Note

Protection classification on cable with UNI-DICHT sealing insert:

- with colour-coded sealing insert: IP 68 - 10 bar in indicated clamping area with multiple sealing inserts to IP 65 and/or IP 68, when bore diameter in seal insert and cable diameter are identical

Threaded connection:

Metric to EN 60423

Each unit includes 1 safety opener

Gland also available with PG thread on request.

Suitable UNI-DICHT sealing inserts are detailed in Section "Cable glands".

Technical data

Protection class by tube: IP 65

Temperature range: -40°C up to +110°C

Metric thread

Part no. grey	Part no. black	Size	Suitable for tube ND	Thread length mm	Unit	Net EUR/100 items at a purchase of		
						up to 100	101 - 500	501 - 1000
920289	920294	M16 x 1,5	10,0	6,0	50	o. r.	o. r.	o. r.
920290	920295	M20 x 1,5	16,0 / 17,0	6,0	50	o. r.	o. r.	o. r.
920291	920296	M25 x 1,5	16,0 / 17,0	6,5	50	o. r.	o. r.	o. r.
920292	920297	M32 x 1,5	21,0 / 23,0	7,0	25	o. r.	o. r.	o. r.
920293	920298	M40 x 1,5	29,0	8,0	25	o. r.	o. r.	o. r.

Dimensions and specifications may be changed without prior notice.

o. r. = on request

HSSV IP68 Corrugated tubes conduit gland - straight

Plastic male thread



HSSV gland straight IP 68

Quick-insert glands for a reliable, quick connection.

Suitable for parallel-corrugated HELUcond protection tubes.

Application

- Plant and machine construction
- Robotics
- Automation technology
- Vehicle construction and shipbuilding
- Installation technology
- Control cabinet construction

Material

Polyamide PA 6

- halogen-free
- cadmium-free

Properties

Resistant to a multitude of

- Fuels
- Mineral oils
- Greases
- Weak bases
- Weak acids

Note

Interior seal made of TPE.

Threaded connection:

Metric to EN 60423

Each unit includes 1 safety opener

Technical data

Protection class: IP 68

Temperature range: -40°C up to +110°C

Metric thread

Part no. grey	Part no. black	Size Metric	Suitable for ND	Thread length mm	Spanner size mm	Unit	Net EUR/100 items at a purchase of		
							up to 100	101 - 500	501 - 1000
920404	920413	M12 x 1,5	10,0	8,9	19,0	50	o. r.	o. r.	o. r.
920405	920414	M16 x 1,5	10,0	9,3	19,0	50	o. r.	o. r.	o. r.
920406	920415	M16 x 1,5	12,0	8,6	21,0	50	o. r.	o. r.	o. r.
920407	920416	M20 x 1,5	16,0 / 17,0	13,0	27,0	50	o. r.	o. r.	o. r.
920408	920417	M25 x 1,5	21,0 / 23,0	14,3	36,0	50	o. r.	o. r.	o. r.
920409	920418	M32 x 1,5	29,0	14,2	40,0	25	o. r.	o. r.	o. r.
920410	920419	M40 x 1,5	36,0 / 37,0	15,0	50,0	25	o. r.	o. r.	o. r.
920411	920420	M50 x 1,5	48,0 / 50,0	15,5	65,0	10	o. r.	o. r.	o. r.
920412	920421	M63 x 1,5	48,0 / 50,0	15,5	65,0	5	o. r.	o. r.	o. r.

Dimensions and specifications may be changed without prior notice.

o. r. = on request

HSSV IP68 Corrugated tubes conduit gland - elbow 90°

Plastic male thread

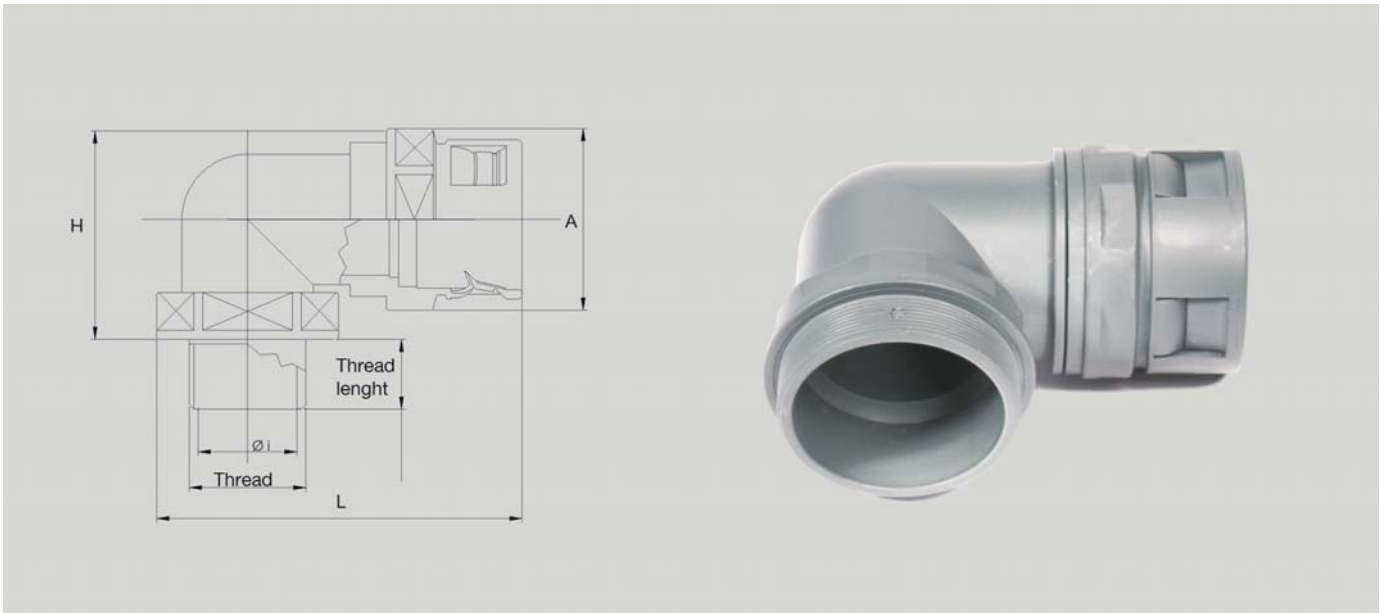

Conduit gland HSSV 90° IP 68

Quick-insert glands for a reliable, quick connection.
Suitable for parallel-corrugated HELUcond protection.

Application

- Plant and machine construction
- Robotics
- Automation technology
- Vehicle construction and shipbuilding
- Railway technology
- Installation technology
- Control cabinet construction

Material

Polyamide PA 6

Flammability acc. to UL 94: V0 tubes.

- halogen-free
- cadmium-free

Properties

Resistant to a multitude of

- Fuels
- Mineral oils
- Greases
- Weak bases
- Weak acids

Note

Interior seal made of TPE.
Threaded connection:
Metric to EN 60423
Each item includes 1 safety opener

Technical data

Protection class: IP 68

Temperature range: -40°C up to +110°C

Metric thread

Part no. grey	Part no. black	Size Metric	Suitable for ND	Thread length mm	Unit	Net EUR/ 100 items at a purchase of		
						up to 100	101 - 500	501 - 1000
920422	920431	M12 x 1,5	10,0	9,5	50	o. r.	o. r.	o. r.
920423	920432	M16 x 1,5	10,0	9,0	50	o. r.	o. r.	o. r.
920424	920433	M16 x 1,5	12,0	8,0	50	o. r.	o. r.	o. r.
920425	920434	M20 x 1,5	17,0	10,5	50	o. r.	o. r.	o. r.
920426	920435	M25 x 1,5	21,0 / 23,0	14,8	50	o. r.	o. r.	o. r.
920427	920436	M32 x 1,5	29,0	13,8	25	o. r.	o. r.	o. r.
920428	920437	M40 x 1,5	36,0 / 37,0	15,6	25	o. r.	o. r.	o. r.
920429	920438	M50 x 1,5	48,0 / 50,0	16,0	10	o. r.	o. r.	o. r.
920430	920439	M63 x 1,5	48,0 / 50,0	15,5	5	o. r.	o. r.	o. r.

Dimensions and specifications may be changed without prior notice.

o. r. = on request

HSSV Opener

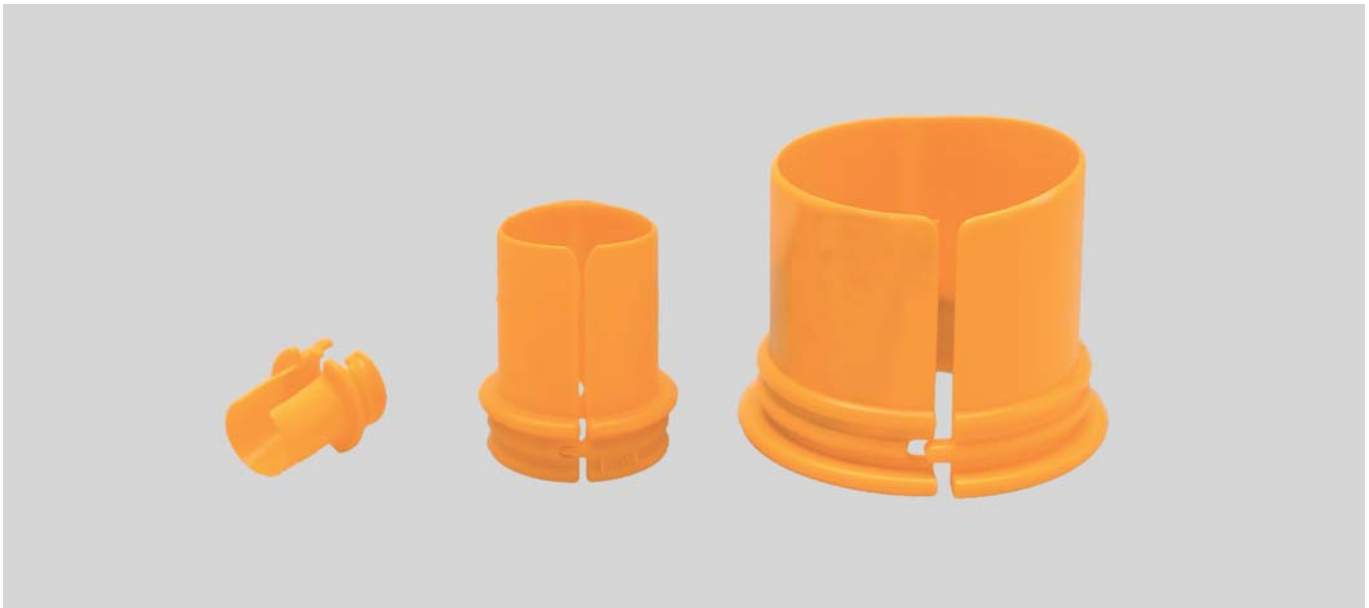

HSSV opener

To open HSSV conduit glands. Simply slip over the conduit - press against the gland - open detent.

Material

Polyamide PA 6

Note

Colour: yellow

Technical data

Temperature range: -20°C up to +100°C

Part no.	Suitable for ND	Unit	Net EUR/100 items at a purchase of		
			1	2 - 5	6 - 10
99891	7,5	10	o. r.	o. r.	o. r.
99892	10,0	10	o. r.	o. r.	o. r.
99893	12,0	10	o. r.	o. r.	o. r.
98744	17,0	10	o. r.	o. r.	o. r.
98745	23,0	5	o. r.	o. r.	o. r.
99894	29,0	5	o. r.	o. r.	o. r.
99895	37,0	5	o. r.	o. r.	o. r.
99896	50,0	5	o. r.	o. r.	o. r.

Dimensions and specifications may be changed without prior notice.

o. r. = on request

HSSV Outer seal



HSSV outer seals

Outer seal for quick-insert glands. Suitable for HSSV glands.

Material

TPE-V

Properties

Resistant to a multitude of

- Oils
- Solvents
- Chemicals

Note

- HSSV + outer seal: IP 66

Technical data

Temperature range: -40°C up to +110°C

Grey					
Part no.	Suitable for ND	Unit	Net EUR/100 items at a purchase of		
grey			up to 100	101 - 500	501 - 1000
920307	7,5	50	o. r.	o. r.	o. r.
920308	10,0	50	o. r.	o. r.	o. r.
920309	12,0	50	o. r.	o. r.	o. r.
920310	17,0	50	o. r.	o. r.	o. r.
920311	23,0	50	o. r.	o. r.	o. r.
920312	29,0	25	o. r.	o. r.	o. r.
920313	37,0	25	o. r.	o. r.	o. r.
920314	50,0	10	o. r.	o. r.	o. r.

Black					
Part no.	Suitable for ND	Unit	Net EUR/100 items at a purchase of		
black			up to 100	101 - 500	501 - 1000
920315	7,5	50	o. r.	o. r.	o. r.
920316	10,0	50	o. r.	o. r.	o. r.
920317	12,0	50	o. r.	o. r.	o. r.
920318	17,0	50	o. r.	o. r.	o. r.
920319	23,0	50	o. r.	o. r.	o. r.
920320	29,0	25	o. r.	o. r.	o. r.
920321	37,0	25	o. r.	o. r.	o. r.
920322	50,0	10	o. r.	o. r.	o. r.

Dimensions and specifications may be changed without prior notice.

o. r. = on request

HSSV-KF Collapsible flange gland



HSSV-KF Collapsible flange gland

Opening flange angle for connection glands or cable glands.

- Flange angle opened to enable simple insertion of pre-assembled cables
- Simple assembly
- Highly stable

Material

Polyamide PA 6

Flammability acc. to UL 94: V0

- halogen-free
- cadmium-free

Properties

Resistant to a multitude of

- Fuels
- Mineral oils
- Greases
- Weak bases
- Weak acids

Note

- UR-tested
- Threaded connection metric to EN 60423

Technical data

Protection class: IP 65

Temperature range: -40°C up to +110°C
Temperature range temporary up to +140°C

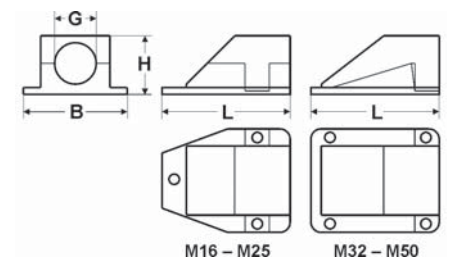

Dimensions

G Thread size inside
H Height
B Width
L Length

Metric thread - female

Part no. grey	Part no. black	Size metr. inside	Height mm	Width mm	Length mm	Unit	Net EUR/100 items at a purchase of		
							up to 100	101 - 500	501 - 1000
920507	920513	M16 x 1,5	35	47	49	10	o. r.	o. r.	o. r.
920508	920514	M20 x 1,5	35	47	49	10	o. r.	o. r.	o. r.
920509	920515	M25 x 1,5	44	65	69	10	o. r.	o. r.	o. r.
920510	920516	M32 x 1,5	55	78	90	10	o. r.	o. r.	o. r.
920511	920517	M40 x 1,5	66	94	99	10	o. r.	o. r.	o. r.
920512	920518	M50 x 1,5	76	101	116	10	o. r.	o. r.	o. r.

Dimensions and specifications may be changed without prior notice.

o. r. = on request

SH, SHV Corrugated tube holder

System holder



SH, SHV- system holder

System holder for HELUcond protection tubes. Universal system holder with optional clips for extreme loads. Quick assembly through single-hole fastening.

Application

- Plant and machine construction
- Robotics
- Automation technology
- Vehicle construction and shipbuilding
- Railway technology
- Installation technology
- Control cabinet construction

Material

Polyamide PA 6

Flammability acc. to UL 94

- halogen-free

Properties

Resistant to a multitude of

- Fuels
- Mineral oils
- Greases
- Weak bases
- Weak acids

Technical data

Temperature range: -40°C up to +110°C

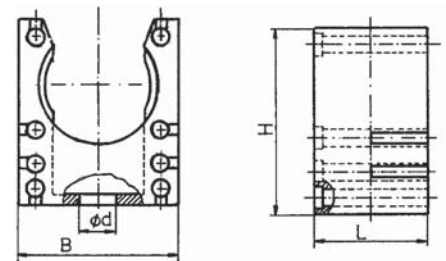

SH holder

Part no. grey	Part no. black	Suitable for tube ND mm	Width mm	Height mm	Unit	Net EUR/100 items at a purchase of		
						up to 100	101 - 500	501 - 1000
94663	99270	7,0	20,0	18,0	100	o. r.	o. r.	o. r.
94664	99271	10,0	20,0	23,0	100	o. r.	o. r.	o. r.
94665	99272	12,0	22,0	26,0	50	o. r.	o. r.	o. r.
920323	920324	14,0	28,0	33,0	50	o. r.	o. r.	o. r.
94666	99273	17,0	28,0	33,0	50	o. r.	o. r.	o. r.
94667	99274	23,0	35,0	40,0	50	o. r.	o. r.	o. r.
94668	99275	29,0	43,0	45,0	30	o. r.	o. r.	o. r.
94669	99276	36,0	54,0	53,0	20	o. r.	o. r.	o. r.
94670	99277	48,0	68,0	66,0	20	o. r.	o. r.	o. r.

SHV holder with rotary protection

Part no. grey	Part no. black	Suitable for tube ND mm	Width mm	Height mm	Unit	Net EUR/100 items at a purchase of		
						up to 100	101 - 500	501 - 1000
920325	920330	16/17	28,0	33,0	50	o. r.	o. r.	o. r.
920326	920331	21/23	35,0	40,0	50	o. r.	o. r.	o. r.
920327	920332	29,0	43,0	45,0	30	o. r.	o. r.	o. r.
920328	920333	36/37	54,0	53,0	20	o. r.	o. r.	o. r.
920329	920334	48/50	68,0	66,0	20	o. r.	o. r.	o. r.

Dimensions and specifications may be changed without prior notice.

o. r. = on request

SD, VS, HT Corrugated tube holder

System holder accessories



SD/ VS/ HT

Accessories for system holder SH/SHV

Material

Polyamide PA 6

- halogen-free

Technical data

Temperature range: -40°C up to +110°C

Properties

Resistant to a multitude of

- Fuels
- Mineral oils
- Greases
- Weak bases
- Weak acids

SD cap for holder

Part no. grey	Part no. black	Suitable for tube ND mm	Unit	Net EUR/100 items at a purchase of		
				up to 100	101 - 500	501 - 1000
94671	99278	7,5/10	100	o. r.	o. r.	o. r.
94672	99279	12,0	50	o. r.	o. r.	o. r.
94673	99280	14/16/17	50	o. r.	o. r.	o. r.
94674	99281	21/23	50	o. r.	o. r.	o. r.
94675	99282	29,0	30	o. r.	o. r.	o. r.
94676	99283	36/37	20	o. r.	o. r.	o. r.
94677	99284	48/50	20	o. r.	o. r.	o. r.

VS bond bridge for holder

Part no. grey	Part no. black	Suitable for tube ND mm	Unit	Net EUR/100 items at a purchase of		
				up to 100	101 - 500	501 - 1000
94679	99286	any	100	o. r.	o. r.	o. r.

HT hut-rail clip for holder

Part no. grey	Part no. black	Suitable for tube ND mm	Unit	Net EUR/100 items at a purchase of		
				up to 100	101 - 500	501 - 1000
94678	99285	any	50	o. r.	o. r.	o. r.

Dimensions and specifications may be changed without prior notice.

o. r. = on request

USH Corrugated tube holder

With flange pipe holder



USH

Tube holder for HELUcond protection tube. Universal, high-strength tube holder with double struts. Fastening bores suitable for horizontal and vertical rail systems in control cabinet.

Application

- Plant and machine construction
- Robotics
- Automation technology
- Vehicle construction and shipbuilding
- Railway technology
- Installation technology
- Control cabinet construction

Material

Polycarbonate

Flammability acc. to UL 94

- halogen-free
- phosphor-free
- cadmium-free

Technical data

Temperature range: -30°C up to +100°C

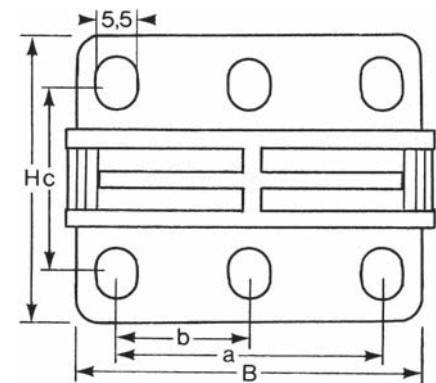

USH with flange pipe holder

Part no. grey	Part no. black	Suitable for tube with outer Ø	Width mm	Height mm	Unit	Net EUR/100 items at a purchase of		
						up to 100	101 - 500	501 - 1000
91200	93497	21,0	38,0	40,0	50	o. r.	o. r.	o. r.
91201	93498	28,5	38,0	40,0	50	o. r.	o. r.	o. r.
91202	93499	34,5	46,0	48,0	50	o. r.	o. r.	o. r.
91203	93507	42,5	52,0	59,0	50	o. r.	o. r.	o. r.
91204	93508	54,5	68,0	77,0	50	o. r.	o. r.	o. r.

Dimensions and specifications may be changed without prior notice.

o. r. = on request

■ HELUCOND PROTECTION TUBE



Cable protection tube distributor

Protection tube distributor for a secure and fast connection.
Suitable for parallel corrugated HELUcond protection tubes.

Application

- Plant construction and mechanical engineering
- Robotics
- Automation technology
- Vehicle construction and shipbuilding
- Railway technology
- Installation technology
- Control cabinet construction

Material properties

- Material:
- Polyamide PA6
 - Halogen-free, cadmium-free
 - In black UV resistant
- Properties:
- Resistant against a number of: fuels, mineral oils, greases weak bases, weak acids

Technical data

- Protection classification:
- IP 54
- Operating temperature:
- 40°C to +110°C
- Recommended warehousing:
- Storage temperature +20°C ±5°C
 - Humidity 55% to 75%

The variable HELUcond protection tube distributor for nominal widths NW 17 reduces to 7.5

1 Basis = 9 different versions

The different variations are numbered from 1 to 9. Please select the required version and indicate the necessary nominal width of the corrugated tube for connection A, B and C. The corrugated tube connections will be pre-assembled at factory following your wishes. You will exactly receive the distributor according to your requirements.

Bore distance: 24 mm / bore diameter: 5.2 mm

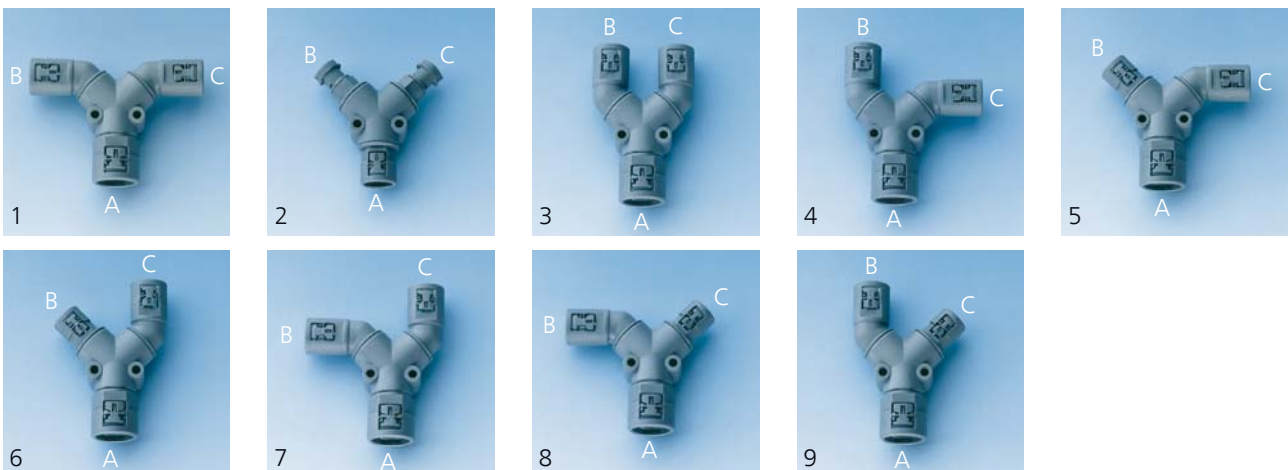

■ HELUCOND PROTECTION TUBE



Cable protection tube distributor

Protection tube distributor for a secure and fast connection.
Suitable for parallel corrugated HELUcond protection tubes.

Application areas:

- Plant construction and mechanical engineering
- Robotics
- Automation technology
- Vehicle construction and shipbuilding
- Railway technology
- Installation technology
- Control cabinet construction

Material properties

Material

- Polyamide PA6
- Halogen-free, cadmium-free
- In black UV resistant

Properties:

- Resistant against a number of: fuels, mineral oils, greases weak bases, weak acids

Technical data

Protection classification:

- IP 54

Operating temperature:

-40°C to +110°C

Recommended warehousing:

- Storage temperature +20°C ±5°C
- Humidity 55% to 75%

The variable HELUcond protection tube distributor for nominal widths NW 29 reduces to 7.5

1 Basis = 2 x 3 different versions

The basic model is the same on both sides and enables 2 x 3 variations.

The different variation possibilities are numbered from 1 to 6.

Please select the required version and indicate the necessary nominal width of the corrugated tube for connection A, B and C.

The corrugated tube connections will be pre-assembled at factory following your wishes.

You will exactly receive the distributor according to your requirements.

Bore distance: 47 mm / bore diameter: 6.2 mm

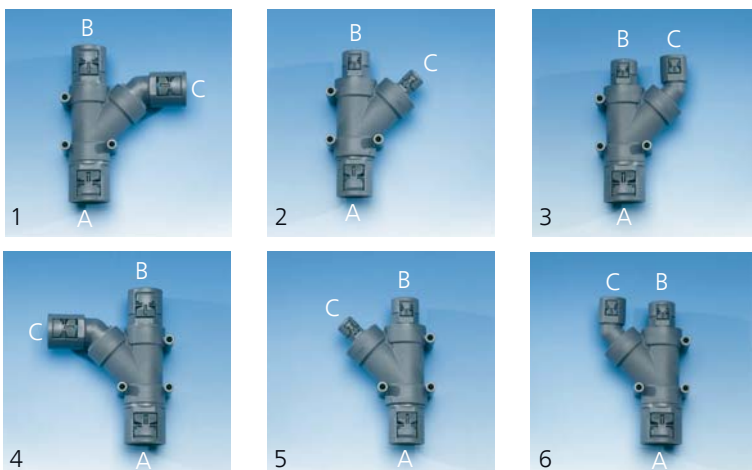

■ JUMBO ASSEMBLY INSTRUCTION

JUMBO

One-piece flange connection
Suitable for parallel corrugated JUMBO protection tubes.

Saves time and money when it comes to install cables and wires to machines and systems.

There are often many cables and wires have to be installed between machines and equipment. These cables and wires are for compressed air or hydraulic liquids or used for power supply cables. For safety reasons, it is recommended to lay these cables in bundles. Therefore, there are protection tubes which protect cables for damages.

So far it has been difficult to replace a damaged cable or to add a new one as the connecting parts - especially those with an angle profile - made it almost impossible to assemble or disassemble the particular cable.

This problem has now been solved by the protection tube form JUMBO series. It features straight and angle single-part profiles.

The JUMBO multi-tubing is pushed by pressure into the threaded joint at an angle of 30° until it clicks in. It is now already pre-fixed. The hinge is locks, this can be done with and without tools. You will benefit from a safe, flexible, and optically appealing cable protection system.

Another advantage of the JUMBO systems is that additional cables can be added and damaged cables can be prreplaced easily and without any problems.

You just need commercial tools to disengage the notch opposite the film flange. The tube is still held. The tubing is dismantled from teh joint by pulling the safety fish at the lever extension of the safety notch.



Easy mounting through pre-locking mechanism

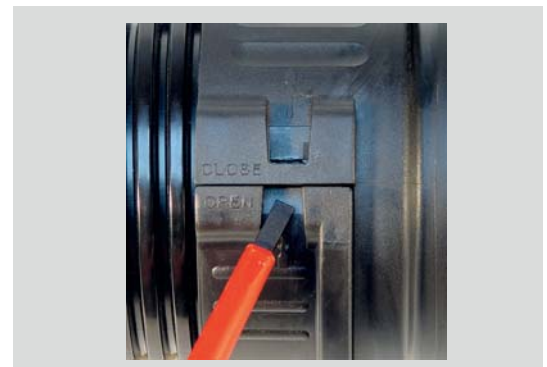

JUMBO PA6 oversize corrugated tubes, polyamide

For heavy-duty mechanical applications

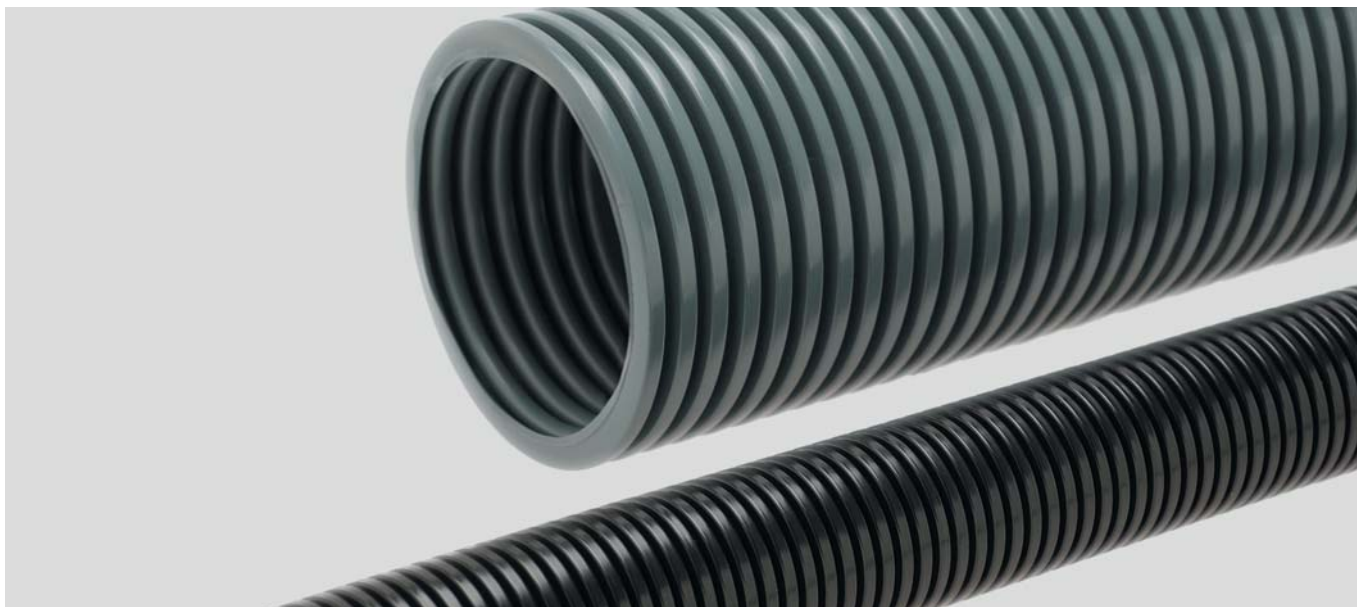

JUMBO PA6

Cable protection tube for medium to heavy-duty applications.
Capacity/100mm: approx. 1200 N / 800 N

Application

- Plant and machine construction
- Robotics
- Automation technology
- Vehicle construction and shipbuilding
- Railway technology
- Installation technology
- Control cabinet construction

Material

Mod. Polyamide PA 6
Flammability acc. to UL 94: V0

- halogen-free
- cadmium-free

Properties

Resistant to a multitude of

- Fuels
- Mineral oils
- Greases
- Weak bases
- Weak acids

Note

Suitable connection glands:
JUMBO gland
Bending behaviour: very good

Technical data

Temperature range: -40°C up to +140°C
Temperature range temporary up to +160°C

Part no. grey	Part no. black	Nominal size mm	Inner Ø mm	Outer Ø mm	Bending radius mm	Per metres	Net EUR/100 metres at a purchase of		
							up to 100	101 - 500	501 - 1000
90408	91362	70	66,2	79,0	160,0	10	o. r.	o. r.	o. r.
90409	91363	95	88,5	105,2	200,0	10	o. r.	o. r.	o. r.

Dimensions and specifications may be changed without prior notice.

o. r. = on request

JUMBO PA12 Oversize corrugated tubes, polyamide PA12

For heavy-duty mechanical applications

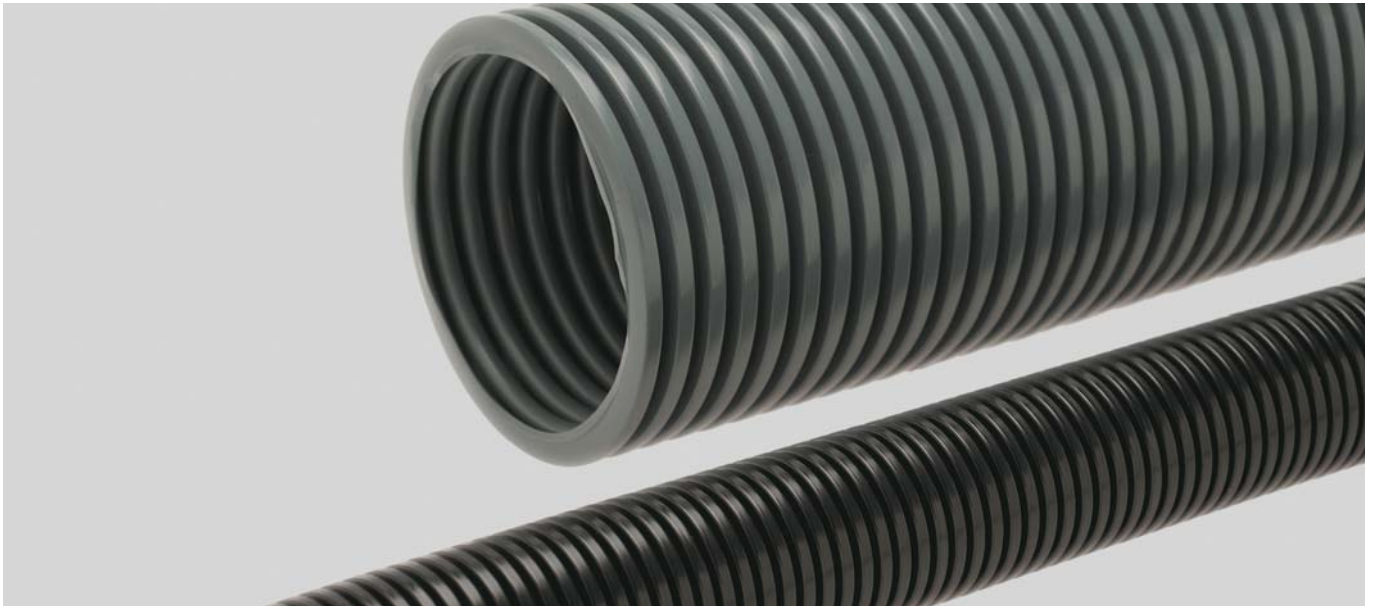

JUMBO PA12

Cable protection tube for heavy-duty applications.

Capacity/100mm: approx. 700 N / 800 N

Application

- Robotics
- Handling systems
- Vehicle construction
- Drag chains

Material

Mod. Polyamide 12

Flammability acc. to UL 94: V0

- halogen-free
- cadmium-free

Properties

Resistant to a multitude of

- Fuels
- Mineral oils
- Greases
- Weak bases
- Weak acids

Note

Suitable connection glands:

JUMBO gland

Bending behaviour: very good

Technical data

Temperature range: -50°C up to +120°C

Temperature range temporary up to +150°C

Part no. grey	Part no. black	Nominal size mm	Inner Ø mm	Outer Ø mm	Bending radius mm	Per metres	Net EUR/100 metres at a purchase of		
							up to 100	101 - 500	501 - 1000
920378	920380	70	66,6	80,0	200,0	10	o. r.	o. r.	o. r.
920379	920381	95	91,0	106,0	265,0	10	o. r.	o. r.	o. r.

Dimensions and specifications may be changed without prior notice.

o. r. = on request

JUMBO PUR oversize corrugated tubes, polyurethane

For maximum mechanical applications

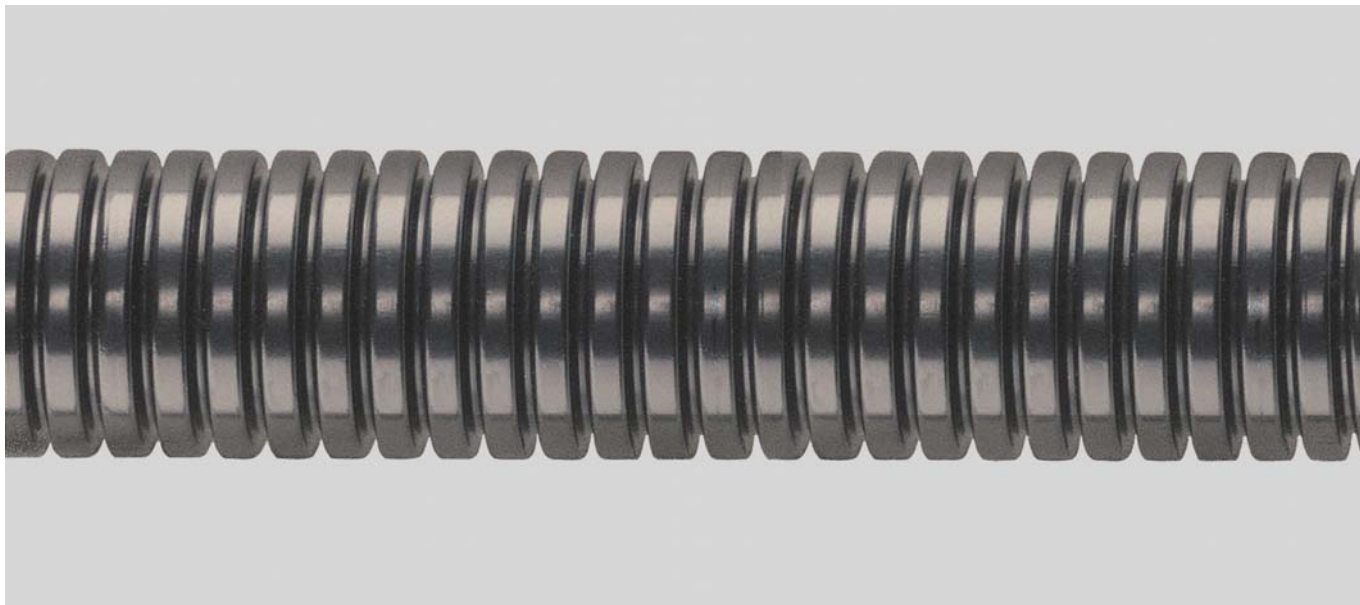

JUMBO PUR

Cable protection tube for maximum duty robot applications.

- Lowest cost quality
 - High abrasion resistance
- Capacity/100mm: approx. 500 N / 800 N

Application

- Robotics
- Handling systems
- Vehicle construction
- Drag chains

Material

Mod. Polyurethane PUR

Flammability acc. to UL 94: HB

- halogen-free
- cadmium-free

Properties

Resistant to a multitude of

- Fuels
- Mineral oils
- Greases
- Weak bases
- Weak acids

Note

Suitable connection glands:
JUMBO gland
Bending behaviour: very good

Technical data

Temperature range: -40°C up to +125°C
Temperature range temporary up to +140°C

Part no. black	Nominal size mm	Inner Ø mm	Outer Ø mm	Bending radius mm	Per metres	Net EUR/ 100 metres at a purchase of		
						up to 100	101 - 500	501 - 1000
920382	70	66,5	79,9	160,0	10	o. r.	o. r.	o. r.
920383	95	91,0	105,9	210,0	10	o. r.	o. r.	o. r.

Dimensions and specifications may be changed without prior notice.

o. r. = on request

JUMBO-FP Flange connection



JUMBO-FP

One-piece straight flange connection. Suitable for parallel-coiled JUMBO protection tubes.

Application

- Plant and machine construction
- Robotics
- Automation technology
- Vehicle construction and shipbuilding
- Railway technology
- Installation technology
- Control cabinet construction

Material

Polyamide PA 6

Flammability acc. to UL 94: V0

- halogen-free
- cadmium-free

Properties

Resistant to a multitude of

- Fuels
- Mineral oils
- Greases
- Weak bases
- Weak acids

Note

Additional seal increases protection classification to IP 65

JUMBO sealing set:

Set contains 1 x o-ring and 1 x cellular rubber seal

Technical data

Protection class: IP 54

Temperature range: -40°C up to +115°C

Flange connection

Part no. grey	Part no. black	Suitable for ND	Unit	Net EUR/100 items at a purchase of		
				up to 100	101 - 500	501 - 1000
90402	920368	70,0	1	o. r.	o. r.	o. r.
90403	920369	95,0	1	o. r.	o. r.	o. r.

Sealing set

Part no.	Colour	Suitable for ND	Unit	Net EUR/100 items at a purchase of		
				up to 100	101 - 500	501 - 1000
90406	black	70,0	1	o. r.	o. r.	o. r.
90407	black	95,0	1	o. r.	o. r.	o. r.

Dimensions and specifications may be changed without prior notice.

o. r. = on request

JUMBO-WFP Flange connection angled 90°



JUMBO-WFP

One-piece flange connection, 90° angle. Suitable for parallel corrugated HELUcond Jumbo protection tubes.

Application

- Plant and machine construction
- Robotics
- Automation technology
- Vehicle construction and shipbuilding
- Railway technology
- Installation technology
- Control cabinet construction

Material

Polyamide PA 6

Flammability acc. to UL 94: V0

- halogen-free
- cadmium-free

Properties

Resistant to a multitude of

- Fuels
- Mineral oils
- Greases
- Weak bases
- Weak acids

Note

Additional seal increases protection classification to IP 65.

JUMBO sealing set:

Set contains 1 x o-ring and 1 x cellular rubber seal.

Technical data

Protection class: IP 54

Temperature range: -40°C up to +115°C

Flange connection – angled 90°

Part no. grey	Part no. black	Suitable for ND	Unit	Net EUR/100 items at a purchase of		
				up to 100	101 - 500	501 - 1000
90404	920372	70,0	1	o. r.	o. r.	o. r.
90405	920373	95,0	1	o. r.	o. r.	o. r.

Sealing set

Part no.	Colour	Suitable for ND	Unit	Net EUR/100 items at a purchase of		
				up to 100	101 - 500	501 - 1000
90406	black	70,0	1	o. r.	o. r.	o. r.
90407	black	95,0	1	o. r.	o. r.	o. r.

Dimensions and specifications may be changed without prior notice.

o. r. = on request

■ SPLIT PROTECTION TUBES

Split protection tubes are perfectly suited for subsequent protection.



Cables and wires are often wired with their connectors. If protection then becomes necessary, HELUcond CO-PA and HELUcond CO-PP are the right solution.

The wires can be inserted into the inner protection tube using the KE cable insertion aid. The second protection tube closes and protects finally. The dividable COV gland including the lock nut protects the housing connection. The tube holder COS and the flanged pipe holder USH are used for fastening the protection tube.

HELUcond CO-PA Corrugated tubes, polyamide

Dividable



HELUcond CO-PA

The dividable and reclosable cable protection tube for subsequent mechanical protection.

- Trouble-free retrofitting
- High mechanical strength
- Simple installation of pre-fabricated cables
- Repair of existing systems

Application

- Plant and machine construction
- Automation technology
- Vehicle construction and shipbuilding
- Railway technology
- Installation technology
- Control cabinet construction

Material

Polyamide 6
UV-resistant

Flammability acc. to UL 94: HB

- halogen-free

Properties

Resistant to a multitude of:

- Fuels
- Mineral oils
- Greases
- Weak bases
- Weak acids

Note

Suitable connection glands:
COV

Technical data

Temperature range: -40°C up to +120°C
Temperature range temporary up to +150°C

Part no. black	Nominal size mm	Inner Ø mm	Outer Ø mm	Per metres	Net EUR/ 100 metres at a purchase of		
					up to 100	101 - 500	501 - 1000
90061	10,0	8,8	13,5	50	o. r.	o. r.	o. r.
90062	14,0	13,2	18,7	50	o. r.	o. r.	o. r.
90063	20,0	20,2	25,7	50	o. r.	o. r.	o. r.
90064	23,0	23,9	31,3	50	o. r.	o. r.	o. r.
90065	37,0	32,5	43,2	25	o. r.	o. r.	o. r.
90066	45,0	43,1	54,2	25	o. r.	o. r.	o. r.
920179	70,0	67,0	79,8	10	o. r.	o. r.	o. r.

Dimensions and specifications may be changed without prior notice.

o. r. = on request

HELUcond CO-PP Corrugated tubes, polypropylene

Dividable



HELUcond CO-PP

The dividable and reclosable cable protection tube for subsequent mechanical protection.

- Trouble-free retrofitting
- High mechanical strength
- Simple installation of pre-fabricated lines
- Repair of existing systems

Application

- Plant and machine construction
- Automation technology
- Vehicle construction and shipbuilding
- Railway technology
- Installation technology
- Control cabinet construction

Material

Polypropylene

Flammability acc. to UL 94: HB

- halogen-free

Properties

Resistant to a multitude of

- Fuels
- Mineral oils
- Greases
- Weak bases
- Weak acids

Note

Suitable connection glands:
COV

Technical data

Temperature range: -40°C up to +135°C
Temperature range temporary up to +150°C

Part no. black	Nominal size mm	Inner Ø mm	Outer Ø mm	Per metres	Net EUR/100 metres at a purchase of		
					up to 100	101 - 500	501 - 1000
97496	10,0	8,4	13,4	50	o. r.	o. r.	o. r.
97134	14,0	12,5	18,5	50	o. r.	o. r.	o. r.
97135	20,0	19,2	25,3	50	o. r.	o. r.	o. r.
97205	23,0	23,4	30,8	50	o. r.	o. r.	o. r.
96732	37,0	31,0	41,4	25	o. r.	o. r.	o. r.
90054	45,0	42,7	54,0	25	o. r.	o. r.	o. r.
920180	70,0	67,5	79,8	10	o. r.	o. r.	o. r.

Dimensions and specifications may be changed without prior notice.

o. r. = on request

COV Corrugated tubes-conduit gland

Dividable



COV tube gland

Tube gland for HELUcond CO protection tubes. Axial fold-up and reclosable connection gland with integrally moulded rods. Split nut with safety lock to prevent accidental opening.

Application

- Plant and machine construction
- Robotics
- Automation technology
- Vehicle construction and shipbuilding
- Railway technology
- Installation technology
- Control cabinet construction

Material

Polyamide PA 6

Flammability acc. to UL 94: HB

- halogen-free

Properties

Resistant to a multitude of

- Fuels
- Mineral oils
- Greases
- Weak bases
- Weak acids

Technical data

Protection class: IP 43 without sealing

Temperature range: -40°C up to +125°C
Temperature range temporary up to +150°C

Metric thread - dividable conduit gland

Part no. black	Size Metric	Suitable for ND	Thread length mm	Spanner size mm	Unit	Net EUR/ 100 items at a purchase of		
						up to 100	101 - 500	501 - 1000
905031	M16 x 1,5	10,0	11,0	19,0	100	o. r.	o. r.	o. r.
905032	M20 x 1,5	14,0	11,0	27,0	100	o. r.	o. r.	o. r.
905033	M25 x 1,5	20,0	12,0	30,0	50	o. r.	o. r.	o. r.
905034	M32 x 1,5	23,0	15,0	36,0	50	o. r.	o. r.	o. r.
905035	M40 x 1,5	37,0	19,0	46,0	25	o. r.	o. r.	o. r.
905036	M50 x 1,5	45,0	19,0	55,0	25	o. r.	o. r.	o. r.

Metric thread - dividable counter nut

Part no. black	Size Metric	Suitable for ND	Thread length mm	Spanner size mm	Unit	Net EUR/ 100 items at a purchase of		
						up to 100	101 - 500	501 - 1000
905037	M16 x 1,5	10,0	8,0	19,0	100	o. r.	o. r.	o. r.
905038	M20 x 1,5	14,0	8,0	27,0	100	o. r.	o. r.	o. r.
905039	M25 x 1,5	20,0	9,0	30,0	50	o. r.	o. r.	o. r.
905040	M32 x 1,5	23,0	12,0	36,0	50	o. r.	o. r.	o. r.
905041	M40 x 1,5	37,0	15,0	46,0	25	o. r.	o. r.	o. r.
905042	M50 x 1,5	45,0	15,0	55,0	25	o. r.	o. r.	o. r.

PG thread - dividable conduit gland wit counter nut

Part no. black	Size PG	Suitable for ND	Thread length mm	Spanner size mm	Unit	Net EUR/ 100 items at a purchase of		
						up to 100	101 - 500	501 - 1000
93514	9	10,0	12,0	22,0	100	o. r.	o. r.	o. r.
93515	13,5	14,0	17,0	30,0	100	o. r.	o. r.	o. r.
93516	21	20,0	17,0	36,0	50	o. r.	o. r.	o. r.
93517	29	23,0	21,0	46,0	50	o. r.	o. r.	o. r.
93518	29	37,0	22,0	55,0	25	o. r.	o. r.	o. r.

Dimensions and specifications may be changed without prior notice.

o. r. = on request

COS Corrugated tubes holder

For dividable corrugated tubes



Tubing clamp COS

Tube holder for dividable HELUcond CO protection tube

- Quick fastening with integrated rib, which also fixes the protection tube in an axial direction

Application

- Plant and machine construction
- Robotics
- Automation technology
- Vehicle construction and shipbuilding
- Railway technology
- Installation technology
- Control cabinet construction

Material

Polyamide PA 6

Flammability acc. to UL 94

- halogen-free
- cadmium-free

Properties

- Resistant to a multitude of fuels, mineral oils, greases, weak bases, weak acids

Technical data

Temperature range: -40°C up to +120°C
Temperature range temporary up to +140°C

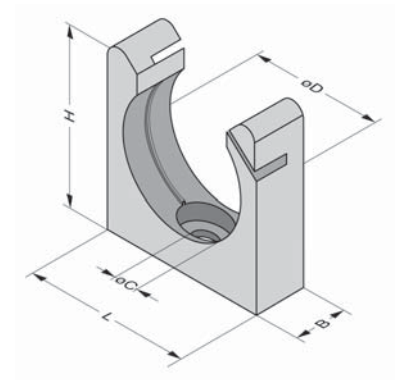

Part no. black	Suitable for tube ND mm	Width mm	Height mm	Unit	Net EUR/ 100 items at a purchase of		
					up to 100	101 - 500	501 - 1000
920375	10,0	20,0	23,0	100	o. r.	o. r.	o. r.
920357	14,0	20,0	27,0	100	o. r.	o. r.	o. r.
920358	20,0	20,0	40,0	50	o. r.	o. r.	o. r.
920359	23,0	20,0	45,0	50	o. r.	o. r.	o. r.
920360	37,0	20,0	52,0	20	o. r.	o. r.	o. r.
920361	45,0	20,0	66,0	20	o. r.	o. r.	o. r.

Dimensions and specifications may be changed without prior notice.

o. r. = on request

KE Insertion aid

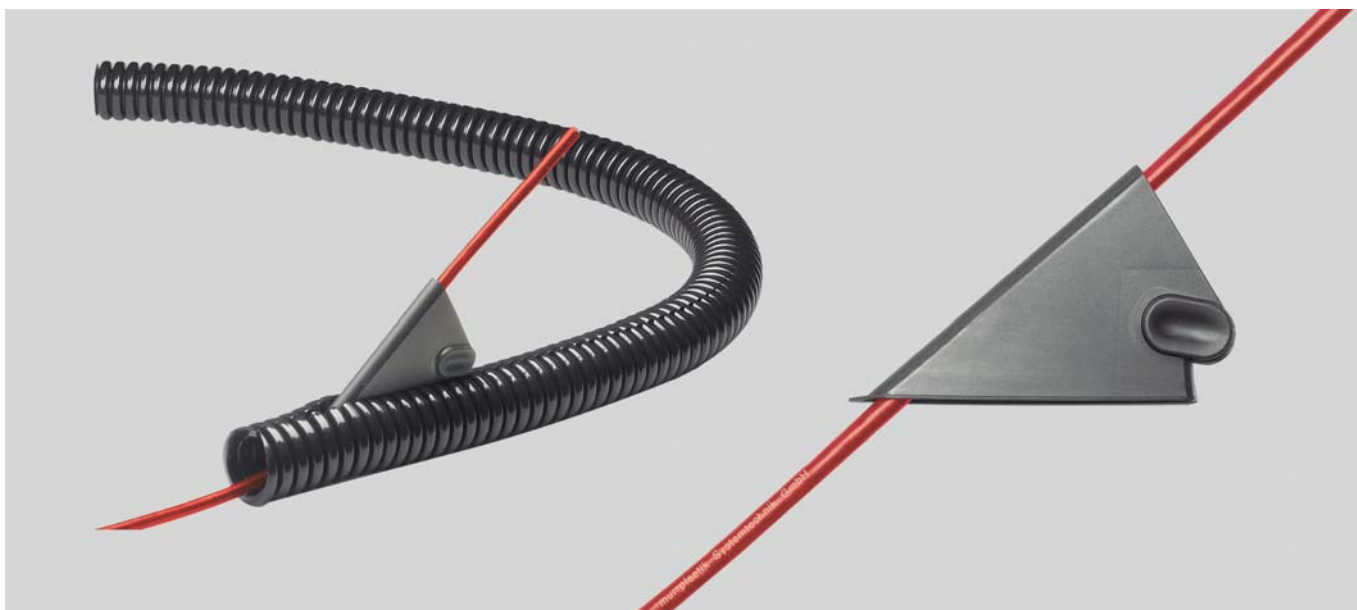

Insertion aid KE

Quick and simple insertion of cables into splitted conduits, resp. cable chain openings

Part no.	Type	Cross-section max. mm ²	Unit	Net EUR/item at a purchase of		
				1	2 - 4	5 - 10
901006	KE	22,0	1	o. r.	o. r.	o. r.

Dimensions and specifications may be changed without prior notice.

o. r. = on request

SPR-AS
LK-I

USK

EEM

LT-E-UI
EEK



S Cable protection tube



With integrated PVC sheathed spring steel wire helix



Type S

Cable protection tube type S with integrated spring steel wire, extremely flexible, expandable and compressible.

Application

- Plant and machine construction
- Automation technology
- Installation technology
- Control cabinet construction

Material

PVC

- silicone-free
- cadmium-free

Note

Suitable connection glands:
USK, LK-I, US and LI

Technical data

Temperature range: -25°C up to +80°C
Temperature range temporary up to +100°C

Part no. grey	Inner Ø mm	Outer Ø mm	Per metres	Net EUR/100 metres at a purchase of		
				up to 100	101 - 500	501 - 1000
91219	7,0	10,0	50	o. r.	o. r.	o. r.
91220	10,0	14,0	50	o. r.	o. r.	o. r.
91221	13,0	17,0	50	o. r.	o. r.	o. r.
91222	15,0	19,0	50	o. r.	o. r.	o. r.
91223	16,0	21,0	50	o. r.	o. r.	o. r.
91224	22,0	27,0	50	o. r.	o. r.	o. r.
91225	29,0	36,0	25	o. r.	o. r.	o. r.
91226	38,0	45,0	25	o. r.	o. r.	o. r.
91228	48,0	56,0	25	o. r.	o. r.	o. r.

Small package

Part no. grey	Inner Ø mm	Outer Ø mm	Per metres	Net EUR/100 metres at a purchase of		
				up to 100	101 - 500	501 - 1000
91270	7,0	10,0	10	o. r.	o. r.	o. r.
91271	10,0	14,0	10	o. r.	o. r.	o. r.
91272	13,0	17,0	10	o. r.	o. r.	o. r.
91273	15,0	19,0	10	o. r.	o. r.	o. r.
91274	16,0	21,0	10	o. r.	o. r.	o. r.
91275	22,0	27,0	10	o. r.	o. r.	o. r.
91276	29,0	36,0	10	o. r.	o. r.	o. r.
91277	38,0	45,0	10	o. r.	o. r.	o. r.
91279	48,0	56,0	10	o. r.	o. r.	o. r.

Dimensions and specifications may be changed without prior notice.

o. r. = on request

S-PU Cable protection tube



With integrated PUR sheathed spring steel wire helix

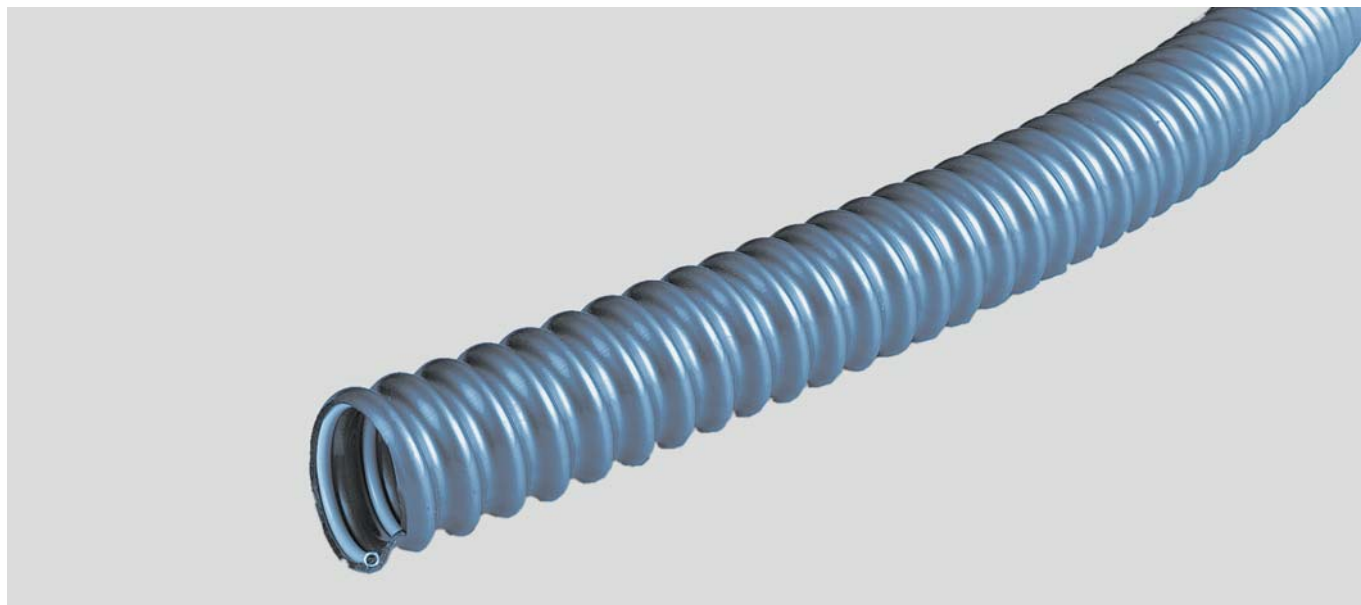

Type S-PU

Cable protection tube type S-PU with PUR outer sheath and integrated spring steel wire, extremely flexible, expandable and compressible.

Application

- Plant and machine construction
- Automation technology
- Installation technology
- Control cabinet construction

Material

Polyurethane
UV-resistant

- halogen-free
- silicone-free
- cadmium-free

Properties

Resistant to

- Oil
- Gasoline
- Microbial attack
- UV-radiation
- Weathering
- Extensively to acids and alkalis

Technical data

Temperature range: -40°C up to +80°C

Note

Suitable connection glands:
USK, LKI, US and LI

Part no. blue	Inner Ø mm	Outer Ø mm	Per metres	Net EUR/100 metres at a purchase of		
				up to 100	101 - 500	501 - 1000
90464	7,0	10,0	50	o. r.	o. r.	o. r.
90465	10,0	14,0	50	o. r.	o. r.	o. r.
90466	13,0	17,0	50	o. r.	o. r.	o. r.
90467	15,0	19,0	50	o. r.	o. r.	o. r.
90468	16,0	21,0	50	o. r.	o. r.	o. r.
90469	21,0	27,0	50	o. r.	o. r.	o. r.
90470	29,0	36,0	25	o. r.	o. r.	o. r.
90471	38,0	45,0	25	o. r.	o. r.	o. r.
90473	48,0	56,0	25	o. r.	o. r.	o. r.

Small package

Part no. blue	Inner Ø mm	Outer Ø mm	Per metres	Net EUR/100 metres at a purchase of		
				up to 100	101 - 500	501 - 1000
94870	7,0	10,0	10	o. r.	o. r.	o. r.
94871	10,0	14,0	10	o. r.	o. r.	o. r.
94872	13,0	17,0	10	o. r.	o. r.	o. r.
94873	15,0	19,0	10	o. r.	o. r.	o. r.
94874	16,0	21,0	10	o. r.	o. r.	o. r.
94875	22,0	27,0	10	o. r.	o. r.	o. r.
94876	29,0	36,0	10	o. r.	o. r.	o. r.
94877	38,0	45,0	10	o. r.	o. r.	o. r.
94879	48,0	56,0	10	o. r.	o. r.	o. r.

Dimensions and specifications may be changed without prior notice.

o. r. = on request

K Cable protection tube

With integrated hard plastic helix

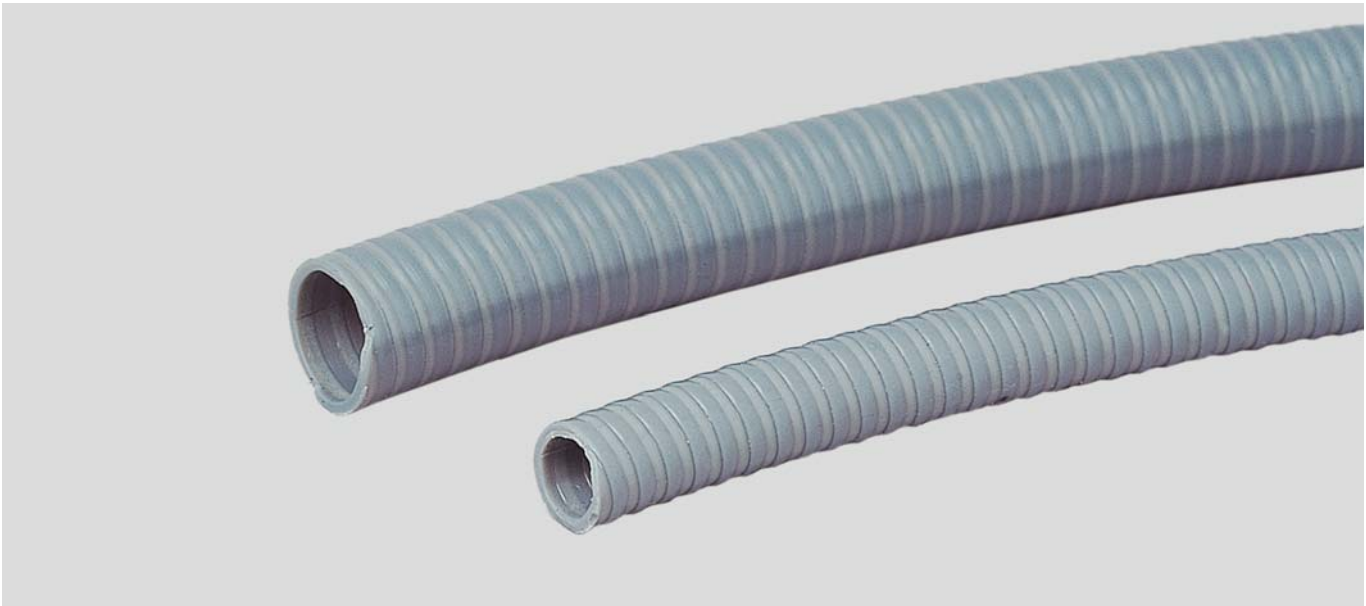

Type K

Cable protection tube with integrated hard plastic winding.

Application

- Plant and machine construction
- Automation technology
- Installation technology
- Control cabinet construction

Material

PVC

- silicone-free
- cadmium-free

Note

Suitable connection glands:
USK, LK-I, US and LI

Technical data

Temperature range: -20°C up to +70°C
Temperature range temporary up to +80°C

Part no. grey	Inner Ø mm	Outer Ø mm	Per metres	Net EUR/100 metres at a purchase of		
				up to 100	101 - 500	501 - 1000
91209	10,0	14,0	50	o. r.	o. r.	o. r.
91210	13,0	17,0	50	o. r.	o. r.	o. r.
91211	15,0	19,0	50	o. r.	o. r.	o. r.
91212	16,0	21,0	50	o. r.	o. r.	o. r.
91213	22,0	27,0	50	o. r.	o. r.	o. r.
91214	30,0	36,0	25	o. r.	o. r.	o. r.
91215	38,0	45,0	25	o. r.	o. r.	o. r.
91216	45,0	52,0	25	o. r.	o. r.	o. r.
91217	49,0	56,0	25	o. r.	o. r.	o. r.

Dimensions and specifications may be changed without prior notice.

o. r. = on request

M Metal cable tube

With Agraff profile



Type M

Spiral wound metallic tube with double-folded profile (Agraff profile).
High tensile and torsional strength.

Material

Cold strip DC 03 acc. to EN 10139, galvanized, Fe/Zn 3
UV-resistant

Technical data

Temperature range: up to +220°C

Application

- Plant and machine construction
- Automation technology
- Installation technology
- Control cabinet construction

Note

Suitable connection glands:
US, LI

Part no.	Inner Ø mm	Outer Ø mm	Per metres	Net EUR/100 metres at a purchase of		
				up to 100	101 - 500	501 - 1000
97014	8,0	10,0	50	o. r.	o. r.	o. r.
97015	12,0	14,0	50	o. r.	o. r.	o. r.
97016	14,0	17,0	50	o. r.	o. r.	o. r.
97017	16,0	19,0	50	o. r.	o. r.	o. r.
97018	18,0	21,0	50	o. r.	o. r.	o. r.
97019	24,0	27,0	50	o. r.	o. r.	o. r.
97020	31,0	36,0	25	o. r.	o. r.	o. r.
97021	40,0	45,0	25	o. r.	o. r.	o. r.
97022	51,0	56,0	25	o. r.	o. r.	o. r.

Dimensions and specifications may be changed without prior notice.

o. r. = on request

SPR-AS Metal cable tube



With latched profile



Type SPR-AS

Spiral wound metal sleeve with hooked profile.
High tensile and transverse pressure load rating.

Material

Cold strip DC 03 acc. to EN 10139, galvanized,
Fe/Zn 3
UV-resistant

Technical data

Temperature range: up to +220°C

Application

- Plant- and machine construction
- Automation and installation technology
- control cabinet construction

Note

Suitable connection glands:
US, LI

Part no.	Inner Ø mm	Outer Ø mm	Per metres	Net EUR/100 metres at a purchase of		
				up to 100	101 - 500	501 - 1000
97023	8,0	10,0	50	o. r.	o. r.	o. r.
97024	11,0	14,0	50	o. r.	o. r.	o. r.
97025	14,0	17,0	50	o. r.	o. r.	o. r.
97026	16,0	19,0	50	o. r.	o. r.	o. r.
97027	18,0	21,0	50	o. r.	o. r.	o. r.
97028	23,0	27,0	50	o. r.	o. r.	o. r.
97029	31,0	36,0	25	o. r.	o. r.	o. r.
97030	40,0	45,0	25	o. r.	o. r.	o. r.
97031	51,0	56,0	25	o. r.	o. r.	o. r.

Small package

Part no.	Inner Ø mm	Outer Ø mm	Per metres	Net EUR/100 metres at a purchase of		
				up to 100	101 - 500	501 - 1000
94880	8,0	10,0	10	o. r.	o. r.	o. r.
94881	11,0	14,0	10	o. r.	o. r.	o. r.
94882	14,0	17,0	10	o. r.	o. r.	o. r.
94883	16,0	19,0	10	o. r.	o. r.	o. r.
94884	18,0	21,0	10	o. r.	o. r.	o. r.
94885	23,0	27,0	10	o. r.	o. r.	o. r.
94886	31,0	36,0	10	o. r.	o. r.	o. r.
94887	40,0	45,0	10	o. r.	o. r.	o. r.
94888	51,0	56,0	10	o. r.	o. r.	o. r.

Dimensions and specifications may be changed without prior notice.

o. r. = on request

SPR-PVC-AS Metal cable tube with plastic sheath



With latched profile



Type SPR-PVC-AS

Spiral wound metallic tube with latched profile and PVC sheath.

Weather-resistant, high tensile and transverse pressure load rating.

Application

- Plant and machine construction
- Automation technology
- Control cabinet construction

Material

Cold strip DC 03 acc. to EN 10139, galvanized, Fe/Zn 3

Outer sheath material: PVC

Note

Suitable connection glands:
US, LI

Technical data

Temperature range: -25°C up to +80°C
Temperature range temporary up to +100°C

Part no. grey	Part no. black	Inner Ø mm	Outer Ø mm	Per metres	Net EUR/100 metres at a purchase of		
					up to 100	101 - 500	501 - 1000
97032	97702	7,0	10,0	50	o. r.	o. r.	o. r.
97033	97685	10,0	14,0	50	o. r.	o. r.	o. r.
97034	97703	13,0	17,0	50	o. r.	o. r.	o. r.
97035	97704	15,0	19,0	50	o. r.	o. r.	o. r.
97036	97705	17,0	21,0	50	o. r.	o. r.	o. r.
97037	97706	22,0	27,0	50	o. r.	o. r.	o. r.
97038	97707	29,0	36,0	25	o. r.	o. r.	o. r.
97039	97708	38,0	45,0	25	o. r.	o. r.	o. r.
97040	97709	49,0	56,0	25	o. r.	o. r.	o. r.

Small package

Part no. grey	Part no. black	Inner Ø mm	Outer Ø mm	Per metres	Net EUR/100 metres at a purchase of		
					up to 100	101 - 500	501 - 1000
94890	94934	7,0	10,0	10	o. r.	o. r.	o. r.
94891	94935	10,0	14,0	10	o. r.	o. r.	o. r.
94892	94936	13,0	17,0	10	o. r.	o. r.	o. r.
94893	94937	15,0	19,0	10	o. r.	o. r.	o. r.
94894	94938	17,0	21,0	10	o. r.	o. r.	o. r.
94895	94939	22,0	27,0	10	o. r.	o. r.	o. r.
94896	94940	29,0	36,0	10	o. r.	o. r.	o. r.
94897	94941	38,0	45,0	10	o. r.	o. r.	o. r.
94898	94942	49,0	56,0	10	o. r.	o. r.	o. r.

Dimensions and specifications may be changed without prior notice.

o. r. = on request

SPR-PU-AS Metal cable tube with PUR sheath



With latched profile

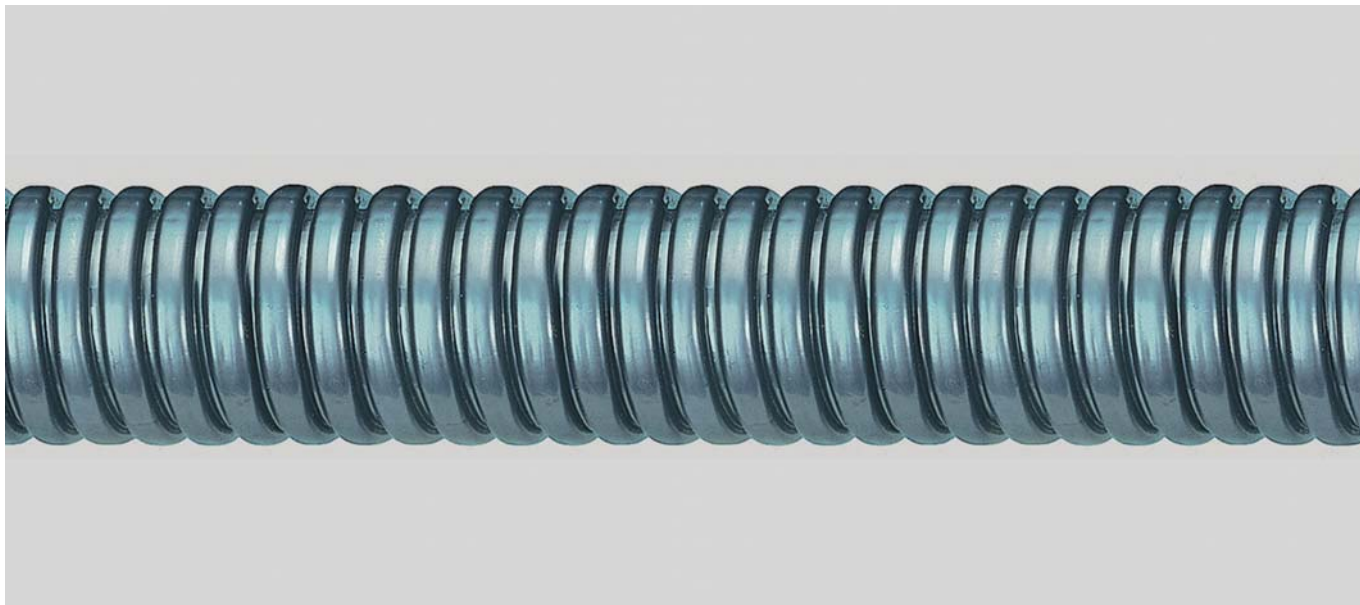

Type SPR-PU-AS

Spiral wound metallic tube with latched profile and steel wire braiding.
High tensile and transverse pressure load rating.

Application

- Plant and machine construction
- Automation technology
- Installation technology
- Control cabinet construction

Material

Galvanized steel
UV-resistant

Outer sheath material: Polyurethane

Note

Suitable connection glands:
US, LI

Technical data

Temperature range: -40°C up to +80°C

Part no. blue	Inner Ø mm	Outer Ø mm	Per metres	Net EUR/100 metres at a purchase of		
				up to 100	101 - 500	501 - 1000
97793	7,0	10,0	50	o. r.	o. r.	o. r.
97794	10,0	14,0	50	o. r.	o. r.	o. r.
91131	13,0	17,0	50	o. r.	o. r.	o. r.
905912	15,0	19,0	50	o. r.	o. r.	o. r.
94738	17,0	21,0	50	o. r.	o. r.	o. r.
97941	22,0	27,0	50	o. r.	o. r.	o. r.
94739	29,0	36,0	25	o. r.	o. r.	o. r.
94714	38,0	45,0	25	o. r.	o. r.	o. r.
90399	49,0	56,0	25	o. r.	o. r.	o. r.

Dimensions and specifications may be changed without prior notice.

o. r. = on request

SPR-EDU-AS Metal cable tube with steel wire braiding



With latched profile



Type SPR-EDU-AS

Spiral wound metallic tube with latched profile and steel wire braiding.
High tensile and transverse pressure load rating.

Material

Cold strip ST 2 acc. to DIN 1624, galvanized, Fe/Zn 3
UV-resistant

Technical data

Temperature range: up to +220°C

Application

- Plant and machine construction
- Automation technology
- Installation technology
- Control cabinet construction

With steel wire braiding

Note

Suitable connection glands:
US, LI

Part no.	Inner Ø mm	Outer Ø mm	Per metres	Net EUR/100 metres at a purchase of		
				up to 100	101 - 500	501 - 1000
97584	7,0	10,0	50	o. r.	o. r.	o. r.
97585	10,0	14,0	50	o. r.	o. r.	o. r.
97586	13,0	17,0	50	o. r.	o. r.	o. r.
97510	15,0	19,0	50	o. r.	o. r.	o. r.
97377	17,0	21,0	50	o. r.	o. r.	o. r.
97378	22,0	27,0	50	o. r.	o. r.	o. r.
97379	29,0	36,0	25	o. r.	o. r.	o. r.
96784	38,0	45,0	25	o. r.	o. r.	o. r.
97587	49,0	56,0	25	o. r.	o. r.	o. r.

Small package

Part no.	Inner Ø mm	Outer Ø mm	Per metres	Net EUR/100 metres at a purchase of		
				up to 100	101 - 500	501 - 1000
94920	7,0	10,0	10	o. r.	o. r.	o. r.
94921	10,0	14,0	10	o. r.	o. r.	o. r.
94922	13,0	17,0	10	o. r.	o. r.	o. r.
94923	15,0	19,0	10	o. r.	o. r.	o. r.
94924	17,0	21,0	10	o. r.	o. r.	o. r.
94925	22,0	27,0	10	o. r.	o. r.	o. r.
94926	29,0	36,0	10	o. r.	o. r.	o. r.
94927	38,0	45,0	10	o. r.	o. r.	o. r.
94928	49,0	56,0	10	o. r.	o. r.	o. r.

Dimensions and specifications may be changed without prior notice.

o. r. = on request

With agraff-profile

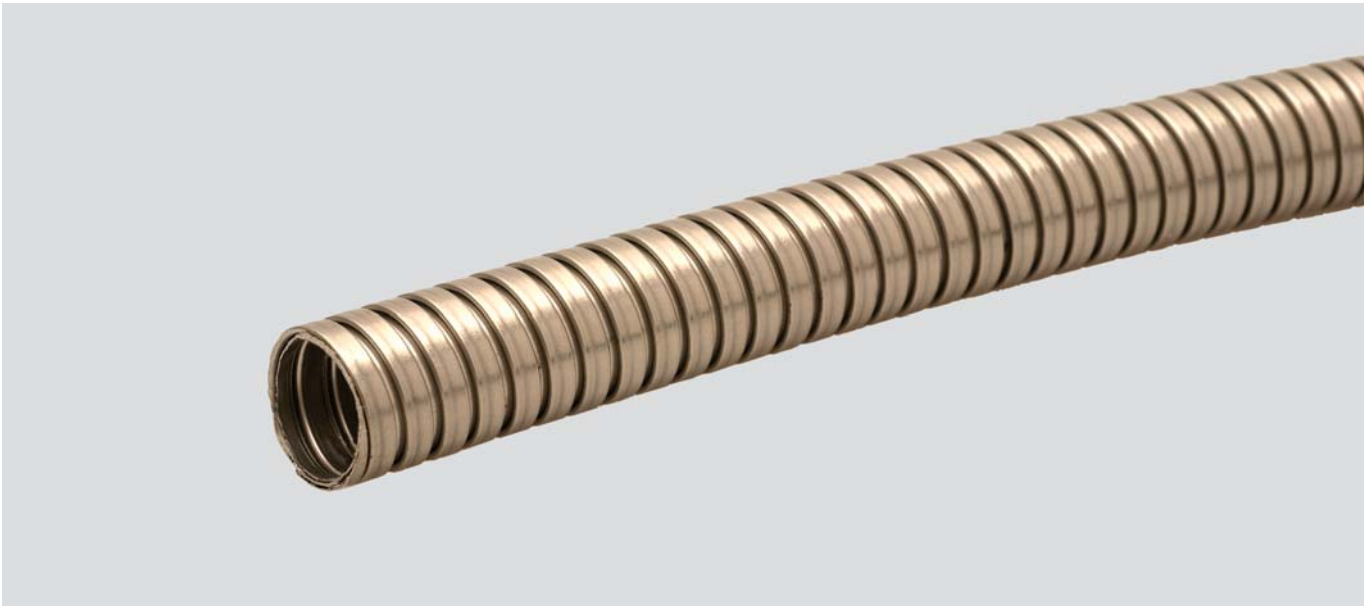

Type UI

Spiral wound tube made by stainless steel with double-folded profile (Agraff profile). High tensile and torsional strength.

Application

- Robotics
- Steel and aluminium foundry industry
- Maschine and apparatus building
- Off-shore-industry
- Security
- Metal, glass and ceramics industry

Material

Stainless steel
UV-resistant

Note

Suitable connection glands:
LT-E-UI

Technical data

Temperature range: -100°C up to +600°C

Part no.	Inner Ø mm	Outer Ø mm	Per metres	Net EUR/100 metres at a purchase of		
				up to 100	101 - 500	501 - 1000
905804	9,5	12,5	30	o. r.	o. r.	o. r.
905805	13,0	16,0	30	o. r.	o. r.	o. r.
905806	17,0	21,0	30	o. r.	o. r.	o. r.
905807	22,0	26,0	30	o. r.	o. r.	o. r.
905808	26,0	30,0	30	o. r.	o. r.	o. r.
905809	34,0	39,0	30	o. r.	o. r.	o. r.
905810	40,3	44,4	15	o. r.	o. r.	o. r.
905811	51,6	55,7	15	o. r.	o. r.	o. r.

Dimensions and specifications may be changed without prior notice.

o. r. = on request

USK Tube connectors, plastic

With high degree of protection



USK

Tube gland for type S, S-PU and K protection tubes.

Material

Polypropylene

Technical data

Protection class: IP 65

Temperature range: -10°C up to +110°C

Application

- Plant and machine construction
- Automation technology
- Installation technology
- Control cabinet construction

Metric thread

Part no. grey	Size Metric	Tube outer Ø mm	Thread length mm	Unit	Net EUR/100 items at a purchase of		
					up to 100	101 - 500	501 - 1000
97594	M10 x 1,0	10,0	10,0	50	o. r.	o. r.	o. r.
97595	M12 x 1,5	14,0	12,0	50	o. r.	o. r.	o. r.
97596	M16 x 1,5	17,0	12,0	50	o. r.	o. r.	o. r.
97597	M20 x 1,5	21,0	13,0	50	o. r.	o. r.	o. r.
97598	M25 x 1,5	27,0	13,0	25	o. r.	o. r.	o. r.
97599	M32 x 1,5	36,0	15,0	25	o. r.	o. r.	o. r.
97600	M40 x 1,5	45,0	15,0	25	o. r.	o. r.	o. r.
97601	M50 x 1,5	56,0	16,0	10	o. r.	o. r.	o. r.

Metric thread - small package

Part no. grey	Size Metric	Tube outer Ø mm	Thread length mm	Unit	Net EUR/100 items at a purchase of		
					up to 100	101 - 500	501 - 1000
93460	M10 x 1,0	10,0	10,0	10	o. r.	o. r.	o. r.
93461	M12 x 1,5	14,0	12,0	10	o. r.	o. r.	o. r.
93462	M16 x 1,5	17,0	12,0	10	o. r.	o. r.	o. r.
93463	M20 x 1,5	21,0	13,0	10	o. r.	o. r.	o. r.
93464	M25 x 1,5	27,0	13,0	10	o. r.	o. r.	o. r.
93465	M32 x 1,5	36,0	15,0	2	o. r.	o. r.	o. r.
93466	M40 x 1,5	45,0	15,0	2	o. r.	o. r.	o. r.
93467	M50 x 1,5	56,0	16,0	2	o. r.	o. r.	o. r.

Continuation ►

USK Tube connectors, plastic

With high degree of protection

PG thread

Part no. grey	Size PG	Tube outer Ø mm	Thread length mm	Unit	Net EUR/100 items at a purchase of		
					up to 100	101 - 500	501 - 1000
90664	7	10,0	10,0	50	o. r.	o. r.	o. r.
90665	9	14,0	10,0	50	o. r.	o. r.	o. r.
90666	11	17,0	10,0	50	o. r.	o. r.	o. r.
90667	13,5	19,0	10,0	50	o. r.	o. r.	o. r.
90668	16	21,0	11,0	50	o. r.	o. r.	o. r.
90669	21	27,0	11,0	25	o. r.	o. r.	o. r.
90670	29	36,0	12,0	25	o. r.	o. r.	o. r.
90671	36	45,0	12,0	25	o. r.	o. r.	o. r.
90673	48	56,0	15,0	10	o. r.	o. r.	o. r.

PG thread - small package

Part no. grey	Size PG	Tube outer Ø mm	Thread length mm	Unit	Net EUR/100 items at a purchase of		
					up to 100	101 - 500	501 - 1000
93450	7	10,0	10,0	10	o. r.	o. r.	o. r.
93451	9	14,0	10,0	10	o. r.	o. r.	o. r.
93452	11	17,0	10,0	10	o. r.	o. r.	o. r.
93453	13,5	19,0	10,0	10	o. r.	o. r.	o. r.
93454	16	21,0	11,0	10	o. r.	o. r.	o. r.
93455	21	27,0	11,0	10	o. r.	o. r.	o. r.
93456	29	36,0	12,0	2	o. r.	o. r.	o. r.
93457	36	45,0	12,0	2	o. r.	o. r.	o. r.
93458	48	56,0	15,0	2	o. r.	o. r.	o. r.

Dimensions and specifications may be changed without prior notice.

o. r. = on request

LK-I Tube connectors, plastic

For flexible use



LK-I

Tube gland for protection tubes type S, S-PU and K.

Material

Polypropylene

Technical data

Protection class: IP 54

Temperature range: -10°C up to +110°C

Application

- Plant and machine construction
- Automation technology
- Installation technology
- Control cabinet construction

Metric thread

Part no. grey	Size Metric	Tube outer Ø mm	Thread length mm	Unit	Net EUR/100 items at a purchase of		
					up to 100	101 - 500	501 - 1000
97602	M12 x 1,5	10,0	10,0	50	o. r.	o. r.	o. r.
97603	M16 x 1,5	14,0	10,0	50	o. r.	o. r.	o. r.
97604	M20 x 1,5	17,0	10,0	50	o. r.	o. r.	o. r.
97605	M25 x 1,5	21,0	11,0	50	o. r.	o. r.	o. r.
97606	M32 x 1,5	27,0	12,0	25	o. r.	o. r.	o. r.
97607	M40 x 1,5	36,0	12,0	25	o. r.	o. r.	o. r.
97608	M50 x 1,5	45,0	12,0	25	o. r.	o. r.	o. r.
97609	M63 x 1,5	56,0	15,0	10	o. r.	o. r.	o. r.

Metric thread - small packages

Part no. grey	Size Metric	Tube outer Ø mm	Thread length mm	Unit	Net EUR/100 items at a purchase of		
					up to 100	101 - 500	501 - 1000
93480	M12 x 1,5	10,0	10,0	10	o. r.	o. r.	o. r.
93481	M16 x 1,5	14,0	10,0	10	o. r.	o. r.	o. r.
93482	M20 x 1,5	17,0	10,0	10	o. r.	o. r.	o. r.
93483	M25 x 1,5	21,0	11,0	10	o. r.	o. r.	o. r.
93484	M32 x 1,5	27,0	12,0	10	o. r.	o. r.	o. r.
93485	M40 x 1,5	36,0	12,0	2	o. r.	o. r.	o. r.
93486	M50 x 1,5	45,0	12,0	2	o. r.	o. r.	o. r.
93487	M63 x 1,5	56,0	15,0	2	o. r.	o. r.	o. r.

Continuation ►

LK-I Tube connectors, plastic

For flexible use

PG thread

Part no. grey	Size PG	Tube outer Ø mm	Thread length mm	Unit	Net EUR/100 items at a purchase of		
					up to 100	101 - 500	501 - 1000
90720	7	10,0	10,0	50	o. r.	o. r.	o. r.
90721	9	14,0	10,0	50	o. r.	o. r.	o. r.
90722	11	17,0	10,0	50	o. r.	o. r.	o. r.
90723	13,5	19,0	10,0	50	o. r.	o. r.	o. r.
90724	16	21,0	11,0	50	o. r.	o. r.	o. r.
90725	21	27,0	11,0	25	o. r.	o. r.	o. r.
90726	29	36,0	12,0	25	o. r.	o. r.	o. r.
90727	36	45,0	12,0	25	o. r.	o. r.	o. r.
90729	48	56,0	15,0	10	o. r.	o. r.	o. r.

PG thread - small packages

Part no. grey	Size PG	Tube outer Ø mm	Thread length mm	Unit	Net EUR/100 items at a purchase of		
					up to 100	101 - 500	501 - 1000
93470	7	10,0	10,0	10	o. r.	o. r.	o. r.
93471	9	14,0	10,0	10	o. r.	o. r.	o. r.
93472	11	17,0	10,0	10	o. r.	o. r.	o. r.
93473	13,5	19,0	10,0	10	o. r.	o. r.	o. r.
93474	16	21,0	11,0	10	o. r.	o. r.	o. r.
93475	21	27,0	11,0	10	o. r.	o. r.	o. r.
93476	29	36,0	12,0	2	o. r.	o. r.	o. r.
93477	36	45,0	12,0	2	o. r.	o. r.	o. r.
93478	48	56,0	15,0	2	o. r.	o. r.	o. r.

Dimensions and specifications may be changed without prior notice.

o. r. = on request

US Tube gland brass nickel plated

With high degree of protection



US

Tube gland for protection tubes type S, S-PU, M, SPR-AS, SPR-PVC-AS, SPR-PU-AS, SPR-EDU-AS.

Material

Brass, nickel plated
Grounding sleeve: Brass, bare
Seal: plastic

Technical data

Temperature range: -25°C up to +100°C

Application

- Plant and machine construction
- Automation technology
- Installation technology
- Control cabinet construction

Note

Protection classification:
IP 65 - type: SPR-PVC-AS, SPR-PU-AS
IP 54 - type: S, S-PU
IP 40 - type: M, SPR-AS, SPR-EDU-AS

Metric thread

Part no. S	Part no. M	Part no. SPR-AS	Part no. SPR-PVC-AS SPR-PU-AS	Part no. SPR-EDU-AS	Size	Tube outer Ø mm	Thread length mm	Unit	Net EUR/100 items at a purchase of		
									up to 100	101 - 500	501 - 1000
98331	98233	98241	98249	905989	M10 x 1,0	10,0	10,0	50	o. r.	o. r.	o. r.
98332	98234	98242	98250	905990	M12 x 1,5	14,0	10,0	50	o. r.	o. r.	o. r.
98333	98235	98243	98251	905991	M16 x 1,5	17,0	10,0	50	o. r.	o. r.	o. r.
98334	98236	98244	98252	905992	M20 x 1,5	21,0	10,0	50	o. r.	o. r.	o. r.
98335	98237	98245	98253	905993	M25 x 1,5	27,0	11,0	25	o. r.	o. r.	o. r.
98336	98238	98246	98254	905994	M32 x 1,5	36,0	13,0	25	o. r.	o. r.	o. r.
98337	98239	98247	98255	905995	M40 x 1,5	45,0	13,0	20	o. r.	o. r.	o. r.
98338	98240	98248	98256	905996	M50 x 1,5	56,0	14,0	10	o. r.	o. r.	o. r.

Metric thread - small package

Part no. S	Part no. M	Part no. SPR-AS	Part no. SPR-PVC-AS SPR-PU-AS	Part no. SPR-EDU-AS	Size Metric	Tube outer Ø mm	Thread length mm	Unit	Net EUR/100 items at a purchase of		
									up to 100	101 - 500	501 - 1000
93530		93570	93590		M10 x 1,0	10,0	10,0	10	o. r.	o. r.	o. r.
93531		93571	93591		M12 x 1,5	14,0	10,0	10	o. r.	o. r.	o. r.
93532		93572	93592		M16 x 1,5	17,0	10,0	10	o. r.	o. r.	o. r.
93533		93573	93593		M20 x 1,5	21,0	10,0	10	o. r.	o. r.	o. r.
93534		93574	93594		M25 x 1,5	27,0	11,0	10	o. r.	o. r.	o. r.
93535		93575	93595		M32 x 1,5	36,0	13,0	2	o. r.	o. r.	o. r.
93536		93576	93596		M40 x 1,5	45,0	13,0	2	o. r.	o. r.	o. r.
93537		93577	93597		M50 x 1,5	56,0	14,0	2	o. r.	o. r.	o. r.

Continuation ►

US Tube gland brass nickel plated

With high degree of protection

PG thread

Part no. S S-PU	Part no. M	Part no. SPR-AS	Part no. SPR-PVC-AS SPR-PU-AS	Part no. SPR-EDU-AS	Size PG	Tube outer Ø mm	Thread length mm	Unit	Net EUR/ 100 items at a purchase of		
									up to 100	101 - 500	501 - 1000
98322	98206	98215	98224	905997	7	10,0	7,0	50	o. r.	o. r.	o. r.
98323	98207	98216	98225	905998	9	14,0	7,0	50	o. r.	o. r.	o. r.
98324	98208	98217	98226	905999	11	17,0	7,0	50	o. r.	o. r.	o. r.
98325	98209	98218	98227	906000	13,5	19,0	7,0	50	o. r.	o. r.	o. r.
98326	98210	98219	98228	906001	16	21,0	7,0	50	o. r.	o. r.	o. r.
98327	98211	98220	98229	906002	21	27,0	10,0	25	o. r.	o. r.	o. r.
98328	98212	98221	98230	906003	29	36,0	10,0	25	o. r.	o. r.	o. r.
98329	98213	98222	98231	906004	36	45,0	10,0	20	o. r.	o. r.	o. r.
98330	98214	98223	98232	906005	48	56,0	10,0	10	o. r.	o. r.	o. r.

PG thread - small package

Part no. S S-PU	Part no. M	Part no. SPR-AS	Part no. SPR-PVC-AS SPR-PU-AS	Part no. SPR-EDU-AS	Size PG	Tube outer Ø mm	Thread length mm	Unit	Net EUR/ 100 items at a purchase of		
									up to 100	101 - 500	501 - 1000
93520		93560	93580		7	10,0	7,0	10	o. r.	o. r.	o. r.
93521		93561	93581		9	14,0	7,0	10	o. r.	o. r.	o. r.
93522		93562	93582		11	17,0	7,0	10	o. r.	o. r.	o. r.
93523		93563	93583		13,5	19,0	7,0	10	o. r.	o. r.	o. r.
93524		93564	93584		16	21,0	7,0	10	o. r.	o. r.	o. r.
93525		93565	93585		21	27,0	10,0	10	o. r.	o. r.	o. r.
93526		93566	93586		29	36,0	10,0	2	o. r.	o. r.	o. r.
93527		93567	93587		36	45,0	10,0	2	o. r.	o. r.	o. r.
93528		93568	93588		48	56,0	10,0	2	o. r.	o. r.	o. r.

Dimensions and specifications may be changed without prior notice.

o. r. = on request

LI Tube gland, metal

With circlip



LI

Tube gland for protection tubes type S, S-PU, M, SPR-AS, SPR-EDU-AS, SPR-PVC-AS. The rotating interior sockets with tube rotation lock is inserted into the gland and secured against tearing by the spring steel ring.

Material

Brass, nickel plated
Grounding sleeve: Brass, bare
Retaining ring: ex spring steel

Technical data

Protection class: IP 40
Temperature range: -40°C up to +250°C

Metric thread

Part no.	Size	Tube outer Ø mm	Thread length mm	Unit	Net EUR/ 100 items at a purchase of		
					up to 100	101 - 500	501 - 1000
97619	M10 x 1,0	10,0	10,0	50	o. r.	o. r.	o. r.
97620	M12 x 1,5	14,0	10,0	50	o. r.	o. r.	o. r.
97621	M16 x 1,5	17,0	10,0	50	o. r.	o. r.	o. r.
97622	M20 x 1,5	21,0	10,0	50	o. r.	o. r.	o. r.
97623	M25 x 1,5	27,0	11,0	25	o. r.	o. r.	o. r.
97624	M32 x 1,5	36,0	13,0	25	o. r.	o. r.	o. r.
97625	M40 x 1,5	45,0	13,0	25	o. r.	o. r.	o. r.
97626	M50 x 1,5	56,0	14,0	25	o. r.	o. r.	o. r.

Metric thread - small packages

Part no.	Size	Tube outer Ø mm	Thread length mm	Unit	Net EUR/ 100 items at a purchase of		
					up to 100	101 - 500	501 - 1000
93610	M10 x 1,0	10,0	10,0	10	o. r.	o. r.	o. r.
93611	M12 x 1,5	14,0	10,0	10	o. r.	o. r.	o. r.
93612	M16 x 1,5	17,0	10,0	10	o. r.	o. r.	o. r.
93613	M20 x 1,5	21,0	10,0	10	o. r.	o. r.	o. r.
93614	M25 x 1,5	27,0	11,0	10	o. r.	o. r.	o. r.
93615	M32 x 1,5	36,0	13,0	2	o. r.	o. r.	o. r.
93616	M40 x 1,5	45,0	13,0	2	o. r.	o. r.	o. r.
93617	M50 x 1,5	56,0	14,0	2	o. r.	o. r.	o. r.

Continuation ►

LI Tube gland, metal

With circlip

PG thread

Part no.	Size PG	Tube outer Ø mm	Thread length mm	Unit	Net EUR/100 items at a purchase of		
					up to 100	101 - 500	501 - 1000
90730	7	10,0	7,0	50	o. r.	o. r.	o. r.
90731	9	14,0	7,0	50	o. r.	o. r.	o. r.
90732	11	17,0	7,0	50	o. r.	o. r.	o. r.
90733	13,5	19,0	7,0	50	o. r.	o. r.	o. r.
90734	16	21,0	7,0	50	o. r.	o. r.	o. r.
90735	21	27,0	10,0	25	o. r.	o. r.	o. r.
90736	29	36,0	10,0	25	o. r.	o. r.	o. r.
90737	36	45,0	10,0	25	o. r.	o. r.	o. r.
90738	48	56,0	10,0	10	o. r.	o. r.	o. r.

PG thread - small packages

Part no.	Size PG	Tube outer Ø mm	Thread length mm	Unit	Net EUR/100 items at a purchase of		
					up to 100	101 - 500	501 - 1000
93600	7	10,0	7,0	10	o. r.	o. r.	o. r.
93601	9	14,0	7,0	10	o. r.	o. r.	o. r.
93602	11	17,0	7,0	10	o. r.	o. r.	o. r.
93603	13,5	19,0	7,0	10	o. r.	o. r.	o. r.
93604	16	21,0	7,0	10	o. r.	o. r.	o. r.
93605	21	27,0	10,0	10	o. r.	o. r.	o. r.
93606	29	36,0	10,0	2	o. r.	o. r.	o. r.
93607	36	45,0	10,0	2	o. r.	o. r.	o. r.
93608	48	56,0	10,0	2	o. r.	o. r.	o. r.

Dimensions and specifications may be changed without prior notice.

o. r. = on request

LT-E-UI Conduit gland - straight

Stainless steel



LT-E-UI straight

LIQUIDTIGHT gland for stainless steel protection tubes UI.
The conical earthing sleeve offers maximum surface contact for optimum sealing and earthing.

Material

Stainless steel
Grounding sleeve: Brass, nickel plated
Seal: Brass, nickel plated
Seal: NBR

- halogen-free

Technical data

Protection class: IP 40

Temperature range: -55°C up to +260°C

Application

- Robotics
- Steel and aluminium foundry industry
- Machine and apparatus building
- Off-shore industry
- Security
- Metal, glass and ceramics industry

Metric thread

Part no.	Size Metric	Tube outer Ø mm	Thread length mm	Min. inner Ø mm	Unit	Net EUR/100 items at a purchase of		
						up to 100	101 - 500	501 - 1000
905812	M16 x 1,5	12,5	12,0	6,8	50	o. r.	o. r.	o. r.
905813	M16 x 1,5	16,0	12,0	9,8	50	o. r.	o. r.	o. r.
905814	M20 x 1,5	12,5	13,0	6,8	50	o. r.	o. r.	o. r.
905815	M20 x 1,5	16,0	13,0	9,8	50	o. r.	o. r.	o. r.
905816	M20 x 1,5	21,0	13,0	13,9	50	o. r.	o. r.	o. r.
905817	M25 x 1,5	26,0	15,0	18,5	25	o. r.	o. r.	o. r.
905818	M32 x 1,5	30,0	15,0	22,8	10	o. r.	o. r.	o. r.
905819	M40 x 1,5	39,0	16,0	30,8	5	o. r.	o. r.	o. r.

PG thread

Part no.	Size PG	Tube outer Ø mm	Thread length mm	Min. inner Ø mm	Unit	Net EUR/100 items at a purchase of		
						up to 100	101 - 500	501 - 1000
905820	11	12,5	12,0	6,8	50	o. r.	o. r.	o. r.
905821	11	16,0	12,0	9,8	50	o. r.	o. r.	o. r.
905822	16	21,0	13,0	13,9	50	o. r.	o. r.	o. r.
905823	21	26,0	15,0	18,5	25	o. r.	o. r.	o. r.
905824	29	30,0	15,0	22,8	10	o. r.	o. r.	o. r.
905825	36	39,0	16,0	30,8	5	o. r.	o. r.	o. r.

NPT thread

Part no.	Size NPT	Tube outer Ø mm	Thread length mm	Min. inner Ø mm	Unit	Net EUR/100 items at a purchase of		
						up to 100	101 - 500	501 - 1000
905826	1/2"	12,5	12,0	6,8	50	o. r.	o. r.	o. r.
905827	1/2"	16,0	12,0	9,8	50	o. r.	o. r.	o. r.
905828	1/2"	21,0	13,0	13,9	50	o. r.	o. r.	o. r.
905829	3/4"	26,0	15,0	18,5	25	o. r.	o. r.	o. r.
905830	1"	30,0	15,0	22,8	10	o. r.	o. r.	o. r.
905831	1 1/4"	39,0	16,0	30,8	5	o. r.	o. r.	o. r.

Dimensions and specifications may be changed without prior notice.

o. r. = on request

LT-E-UI Conduit gland - 90°



Stainless steel



LT-E-UI 90°

LIQUIDTIGHT conduit gland for stainless steel protection tubes UI.
The conical earthing sleeve offers maximum surface contact for optimum sealing and earthing.

Material

Stainless steel
Grounding sleeve: Brass, nickel plated
Seal: Brass, nickel plated
Seal: NBR

- halogen-free

Technical data

Protection class: IP 40

Temperature range: -55°C up to +260°C

Application

- Robotics
- Steel and aluminium foundry industry
- Machine and apparatus building
- Off-shore industry
- Security
- Metal, glass and ceramics industry

Metric thread

Part no.	Size Metric	Tube outer Ø mm	Thread length mm	Min. inner Ø mm	Unit	Net EUR/100 items at a purchase of		
						up to 100	101 - 500	501 - 1000
905832	M16 x 1,5	12,5	12,0	6,8	50	o. r.	o. r.	o. r.
905833	M16 x 1,5	16,0	12,0	9,8	50	o. r.	o. r.	o. r.
905834	M20 x 1,5	12,5	13,0	6,8	50	o. r.	o. r.	o. r.
905835	M20 x 1,5	16,0	13,0	9,8	50	o. r.	o. r.	o. r.
905836	M20 x 1,5	21,0	13,0	13,9	50	o. r.	o. r.	o. r.
905837	M25 x 1,5	26,0	15,0	18,5	25	o. r.	o. r.	o. r.

PG thread

Part no.	Size PG	Tube outer Ø mm	Thread length mm	Min. inner Ø mm	Unit	Net EUR/100 items at a purchase of		
						up to 100	101 - 500	501 - 1000
905838	11	12,5	12,0	6,8	50	o. r.	o. r.	o. r.
905839	11	16,0	12,0	9,8	50	o. r.	o. r.	o. r.
905840	16	21,0	13,0	13,9	50	o. r.	o. r.	o. r.
905841	21	26,0	15,0	18,5	25	o. r.	o. r.	o. r.
905842	29	30,0	15,0	22,8	10	o. r.	o. r.	o. r.

NPT thread

Part no.	Size NPT	Tube outer Ø mm	Thread length mm	Min. inner Ø mm	Unit	Net EUR/100 items at a purchase of		
						up to 100	101 - 500	501 - 1000
905843	1/2"	12,5	12,0	6,8	50	o. r.	o. r.	o. r.
905844	1/2"	16,0	12,0	9,8	50	o. r.	o. r.	o. r.
905845	1/2"	21,0	13,0	13,9	50	o. r.	o. r.	o. r.
905846	3/4"	26,0	15,0	18,5	25	o. r.	o. r.	o. r.
905847	1"	30,0	15,0	22,8	10	o. r.	o. r.	o. r.

Dimensions and specifications may be changed without prior notice.

o. r. = on request

EEK Inner sleeve

PVC



EEK

Inner sleeve EEK made of PVC for plastic conduits type K, S and S-PU.

Material

PVC

Technical data

Temperature range: -25°C up to +100°C

EEK - PVC

Part no.	Tube outer Ø mm	Unit	Net EUR/100 items at a purchase of		
			up to 100	101 - 500	501 - 1000
96342	10,0	50	o. r.	o. r.	o. r.
96449	14,0	50	o. r.	o. r.	o. r.
96343	17,0	50	o. r.	o. r.	o. r.
96450	19,0	50	o. r.	o. r.	o. r.
96451	21,0	50	o. r.	o. r.	o. r.
96344	27,0	25	o. r.	o. r.	o. r.
96447	36,0	25	o. r.	o. r.	o. r.
96345	45,0	25	o. r.	o. r.	o. r.
96347	56,0	10	o. r.	o. r.	o. r.

Dimensions and specifications may be changed without prior notice.

o. r. = on request

EEM Inner sleeve

Brass



EEM

Inner sleeve EEM made of brass for metal conduits type M, SPR-AS, SPR-PVC-AS, SPR-PU-AS und SPR-EDU-AS.

Material

Brass

Technical data

Temperature range: -40°C up to +150°C

EEM - brass

Part no. M	Tube outer Ø mm	Unit	Net EUR/100 items at a purchase of		
			up to 100	101 - 500	501 - 1000
906006	10,0	50	o. r.	o. r.	o. r.
906007	14,0	50	o. r.	o. r.	o. r.
906008	17,0	50	o. r.	o. r.	o. r.
906009	19,0	50	o. r.	o. r.	o. r.
906010	21,0	50	o. r.	o. r.	o. r.
906011	27,0	25	o. r.	o. r.	o. r.
906012	36,0	25	o. r.	o. r.	o. r.
906013	45,0	20	o. r.	o. r.	o. r.
906014	56,0	10	o. r.	o. r.	o. r.

EEM - brass

Part no. SPR-AS	Tube outer Ø mm	Unit	Net EUR/100 items at a purchase of		
			up to 100	101 - 500	501 - 1000
99510	10,0	50	o. r.	o. r.	o. r.
99511	14,0	50	o. r.	o. r.	o. r.
99512	17,0	50	o. r.	o. r.	o. r.
99513	19,0	50	o. r.	o. r.	o. r.
99514	21,0	50	o. r.	o. r.	o. r.
99515	27,0	25	o. r.	o. r.	o. r.
99516	36,0	25	o. r.	o. r.	o. r.
99517	45,0	25	o. r.	o. r.	o. r.
99518	56,0	10	o. r.	o. r.	o. r.

Part no. SPR-PVC-AS SPR-PU-AS SPR-EDU-AS	Tube outer Ø mm	Unit	Net EUR/100 items at a purchase of		
			up to 100	101 - 500	501 - 1000
97580	10,0	50	o. r.	o. r.	o. r.
97680	14,0	50	o. r.	o. r.	o. r.
97691	17,0	50	o. r.	o. r.	o. r.
97692	19,0	50	o. r.	o. r.	o. r.
97693	21,0	50	o. r.	o. r.	o. r.
97681	27,0	25	o. r.	o. r.	o. r.
97682	36,0	25	o. r.	o. r.	o. r.
97694	45,0	25	o. r.	o. r.	o. r.
97684	56,0	10	o. r.	o. r.	o. r.

Dimensions and specifications may be changed without prior notice.

o. r. = on request

EES

T&B TUBE CONNECTOR

LT-CNP



ANACONDA

SEALTITE®



EF

Universal applications.
Protection tube from reinforced, galvanized steel band with spiral wound, latched profile, a continuous cord seal and extruded plastic sheath. This complex construction method keeps the plastic sheath and the internal tube together.

Material

Galvanized steel

Outer sheath material: PVC

Note

Suitable connection glands:
LT straight, LT angled, T&B straight, T&B angled.
Dimensions 2 1/2", 3", 4", 5" and 6" available on request.

Technical data

Protection class: IP 67

Temperature range: -25°C up to +70°C
Temperature range temporary up to +90°C

Part no. grey	Part no. black	Trade size inch	Inner Ø mm	Outer Ø mm	Per metres	Net EUR/100 metres at a purchase of		
						up to 100	101 - 500	501 - 1000
91229	96939	1/4"	6,4	11,5	50	o. r.	o. r.	o. r.
91230	96248	5/16"	10,1	14,4	50	o. r.	o. r.	o. r.
91231	96249	3/8"	12,6	17,8	75	o. r.	o. r.	o. r.
91232	97153	1/2"	16,0	21,1	60	o. r.	o. r.	o. r.
91233	96718	3/4"	21,0	26,4	50	o. r.	o. r.	o. r.
91234	96250	1"	26,5	33,1	30	o. r.	o. r.	o. r.
91235	96251	1 1/4"	35,1	41,8	30	o. r.	o. r.	o. r.
91236	97175	1 1/2"	40,3	47,8	15	o. r.	o. r.	o. r.
91237	96252	2"	51,6	59,9	15	o. r.	o. r.	o. r.

Small package

Part no. grey	Part no. black	Trade size inch	Inner Ø mm	Outer Ø mm	Per metres	Net EUR/100 metres at a purchase of		
						up to 100	101 - 500	501 - 1000
94915	94930	5/16"	10,1	14,4	10	o. r.	o. r.	o. r.
94916	94931	3/8"	12,6	17,8	10	o. r.	o. r.	o. r.
94917	94932	1/2"	16,0	21,1	10	o. r.	o. r.	o. r.
94918	94933	3/4"	21,0	26,4	10	o. r.	o. r.	o. r.

Dimensions and specifications may be changed without prior notice.

o. r. = on request



OR

Resistant to oil, grease, alkalis and acids. Protection tubes from reinforced, galvanized steel band with spiral wound, latched profile, a continuous cord seal and extruded plastic sheath. This complex construction method keeps the plastic sheath and the internal tube together.

Material

Galvanized steel
UV-resistant

Outer sheath material: Special PVC

Note

Suitable connection glands:
LT straight, LT angled, T&B straight, T&B angled.

Technical data

Protection class: IP 67

Temperature range: -15°C up to +100°C
Temperature range temporary up to +120°C

Part no. black	Trade size inch	Inner Ø mm	Outer Ø mm	Per metres	Net EUR/100 metres at a purchase of		
					up to 100	101 - 500	501 - 1000
91245	3/8"	12,6	17,8	75	o. r.	o. r.	o. r.
91246	1/2"	16,0	21,1	60	o. r.	o. r.	o. r.
91247	3/4"	21,0	26,4	50	o. r.	o. r.	o. r.
91248	1"	26,5	33,1	30	o. r.	o. r.	o. r.
91249	1 1/4"	35,1	41,8	30	o. r.	o. r.	o. r.
91250	1 1/2"	40,3	47,8	15	o. r.	o. r.	o. r.
91251	2"	51,6	59,9	15	o. r.	o. r.	o. r.

Dimensions and specifications may be changed without prior notice.

o. r. = on request



HTDL

UL/CSA approval, good EMC properties.
Protection tube from reinforced, galvanized steel band with spiral wound, latched profile, a continuous copper conductor and extruded plastic sheath.

This complex construction method keeps the plastic sheath and the internal tube together.

Material

Galvanized steel
UV-resistant

Outer sheath material: PVC

Note

Suitable connection glands:
LT straight, LT angled, T&B straight, T&B angled.
Up to 1 1/4" with copper conductor.

Technical data

Protection class: IP 67

Temperature range: -45°C up to +105°C
Temperature range temporary up to +120°C

Part no. black	Trade size inch	Inner Ø mm	Outer Ø mm	Per metres	Net EUR/100 metres at a purchase of		
					up to 100	101 - 500	501 - 1000
98149	3/8"	12,6	17,8	60	o. r.	o. r.	o. r.
98150	1/2"	16,1	21,1	60	o. r.	o. r.	o. r.
98151	3/4"	21,1	26,4	45	o. r.	o. r.	o. r.
98152	1"	26,8	33,1	30	o. r.	o. r.	o. r.
98153	1 1/4"	35,4	41,8	15	o. r.	o. r.	o. r.
98154	1 1/2"	40,3	47,8	15	o. r.	o. r.	o. r.
98155	2"	51,6	59,9	15	o. r.	o. r.	o. r.

Dimensions and specifications may be changed without prior notice.

o. r. = on request



HC

For extremely extensive temperature ranges. Protection tubes from reinforced, galvanized steel band with spiral wound, latched profile, a continuous cord seal and extruded plastic sheath. This complex construction method keeps the plastic sheath and the internal tube together.

Material

Galvanized steel
UV-resistant

Outer sheath material: PVC

Note

Suitable connection glands:
LT straight, LT angled, T&B straight, T&B angled.

Technical data

Protection class: IP 67

Temperature range: -45°C up to +105°C
Temperature range temporary up to +120°C

Part no. black	Trade size inch	Inner Ø mm	Outer Ø mm	Per metres	Net EUR/100 metres at a purchase of		
					up to 100	101 - 500	501 - 1000
91238	3/8"	12,6	17,8	75	o. r.	o. r.	o. r.
91239	1/2"	16,0	21,1	60	o. r.	o. r.	o. r.
91240	3/4"	21,0	26,4	50	o. r.	o. r.	o. r.
91241	1"	26,5	33,1	30	o. r.	o. r.	o. r.
91242	1 1/4"	35,1	41,8	30	o. r.	o. r.	o. r.
91243	1 1/2"	40,3	47,8	15	o. r.	o. r.	o. r.
91244	2"	51,6	59,9	15	o. r.	o. r.	o. r.

Dimensions and specifications may be changed without prior notice.

o. r. = on request



HCX

For extensive temperature ranges. Protection tubes from reinforced, galvanized steel band with spiral wound, latched profile, a continuous cord seal and extruded plastic sheath. This complex construction method keeps the plastic sheath and the internal tube together.

Material

Galvanized steel
UV-resistant

Outer sheath material: Elastomer

Note

Suitable connection glands:
LT straight, LT angled, T&B straight, T&B angled

Technical data

Protection class: IP 67

Temperature range: -55°C up to +145°C
Temperature range temporary up to +160°C

Part no. black	Trade size inch	Inner Ø mm	Outer Ø mm	Per metres	Net EUR/100 metres at a purchase of		
					up to 100	101 - 500	501 - 1000
94735	3/8"	12,6	17,8	30	o. r.	o. r.	o. r.
96410	1/2"	16,0	21,1	30	o. r.	o. r.	o. r.
96954	3/4"	21,0	26,4	30	o. r.	o. r.	o. r.
97945	1"	26,5	33,1	30	o. r.	o. r.	o. r.
96247	1 1/4"	35,1	41,8	15	o. r.	o. r.	o. r.
97668	1 1/2"	40,3	47,8	15	o. r.	o. r.	o. r.
97811	2"	51,6	59,9	15	o. r.	o. r.	o. r.

Dimensions and specifications may be changed without prior notice.

o. r. = on request



ZHLS

Halogen-free, low smoke generation.
Protection tube from reinforced, galvanized steel band with spiral wound, latched profile, a continuous cord seal and extruded plastic sheath. This complex construction method keeps the plastic sheath and the internal tube together.

Material

UV-resistant

Outer sheath material: Polyolefin

- halogen-free

Technical data

Protection class: IP 67

Temperature range: -25°C up to +80°C
Temperature range temporary up to +100°C

Note

Suitable connection glands:
LT straight, LT angled, T&B straight, T&B angled

Part no. black	Trade size inch	Inner Ø mm	Outer Ø mm	Per metres	Net EUR/100 metres at a purchase of		
					up to 100	101 - 500	501 - 1000
94988	5/16"	10,1	14,4	30	o. r.	o. r.	o. r.
94989	3/8"	12,6	17,8	30	o. r.	o. r.	o. r.
94990	1/2"	16,0	21,1	30	o. r.	o. r.	o. r.
94991	3/4"	21,0	26,4	30	o. r.	o. r.	o. r.
94992	1"	26,5	33,1	30	o. r.	o. r.	o. r.
94993	1 1/4"	35,1	41,8	15	o. r.	o. r.	o. r.

Dimensions and specifications may be changed without prior notice.

o. r. = on request



HFX

Halogen-free, low smoke generation, UV-resistant, oil-resistant, weather-resistant. Protection tube from reinforced, galvanized steel band with spiral wound, latched profile, a continuous cord seal and extruded plastic sheath. This complex construction method keeps the plastic sheath and the internal tube together.

Material

Galvanized steel
UV-resistant

Outer sheath material: Polyurethane

- halogen-free

Properties

Low toxicity in case of fire.
Flexible at low temperatures, very good UV-resistance and oil resistance.
EN standard approved tube, for railways, tunnels, ships, public buildings.

Note

Suitable connection glands:
T&B straight, T&B angled, Anamet straight, Anamet angled

Technical data

Protection class: IP 67

Temperature range: -45°C up to +105°C
Temperature range temporary up to +125°C

Part no. black	Trade size inch	Inner Ø mm	Outer Ø mm	Per metres	Net EUR/100 metres at a purchase of		
					up to 100	101 - 500	501 - 1000
94994	5/16"	10,1	14,4	30	o. r.	o. r.	o. r.
94995	3/8"	12,6	17,8	30	o. r.	o. r.	o. r.
94996	1/2"	16,0	21,1	30	o. r.	o. r.	o. r.
94997	3/4"	21,0	26,4	30	o. r.	o. r.	o. r.
94998	1"	26,5	33,1	30	o. r.	o. r.	o. r.
94999	1 1/4"	35,1	41,8	15	o. r.	o. r.	o. r.

Dimensions and specifications may be changed without prior notice.

o. r. = on request



CNP

Full plastic, UL/CSA approval.
Extremely abrasion-resistant plastic tube for heavy-duty applications.
Construction: Neoprene internal tube with nylon weave and abrasion-proof special PVC sheath.
Very good UV- and oil-resistance

Material

PVC
UV-resistant

Outer sheath material: PVC
With woven nylon insert

Technical data

Protection class: IP 67

Temperature range: -20°C up to +60°C
Temperature range temporary up to +80°C

Note

Suitable connection glands:
LT-CNP and LT-CNP-E

Part no. orange	Trade size inch	Inner Ø mm	Outer Ø mm	Per metres	Net EUR/100 metres at a purchase of		
					up to 100	101 - 500	501 - 1000
91259	3/8"	12,6	19,4	76	o. r.	o. r.	o. r.
91260	1/2"	16,1	23,4	60	o. r.	o. r.	o. r.
91261	3/4"	21,0	29,5	53	o. r.	o. r.	o. r.
91262	1"	26,5	36,3	30	o. r.	o. r.	o. r.
91263	1 1/4"	35,1	46,0	15	o. r.	o. r.	o. r.
91264	1 1/2"	40,7	52,4	15	o. r.	o. r.	o. r.
91265	2"	52,4	66,6	15	o. r.	o. r.	o. r.

Dimensions and specifications may be changed without prior notice.

o. r. = on request

Anaconda Sealtite® NMFG-Clean

For highest standards of cleanliness and purity

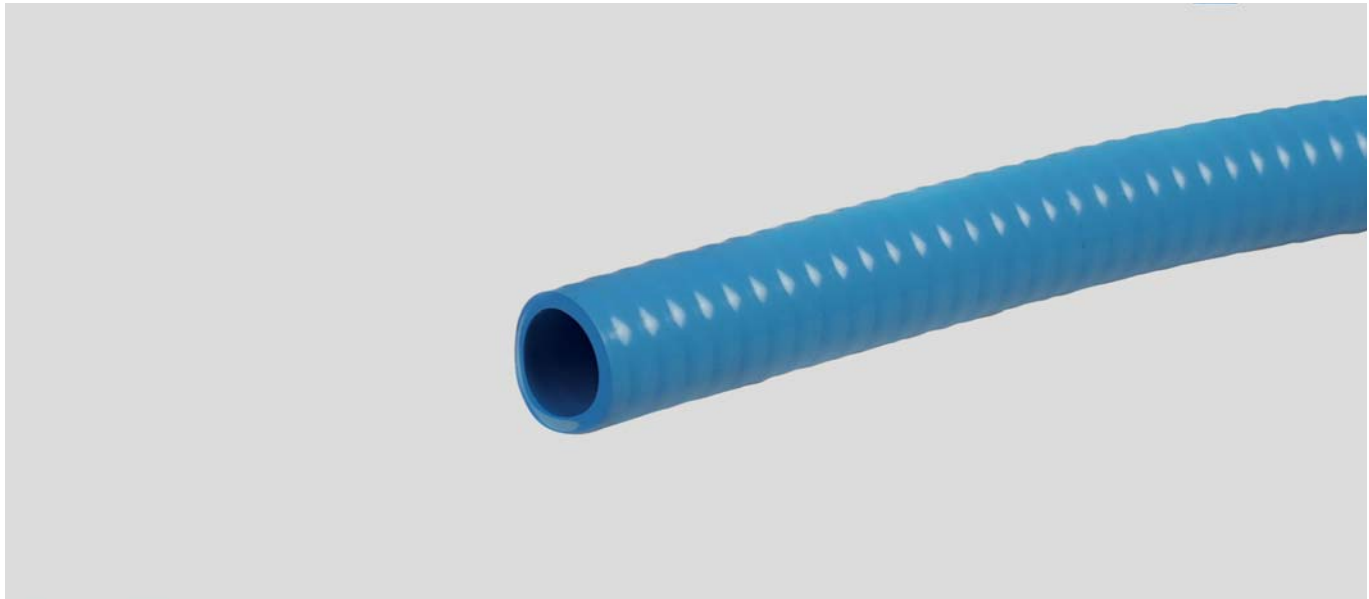

NMFG-Clean, blue

Thick, soft, smooth, thermoplastic PVC tube with integrated Hard PVC spiral

Application

- Food industry - milk - and meat products
- Packaging of food machines
- Beverage industry
- Pharmaceutical industry
- Biotechnology
- Chemical industry

Material

Special PVC according to FDA CFR 21 and NSF 51 (USA-standard)

Properties

- Liquid tight
- The smooth surface prevents to adhere harmful micro organisms
- Easy and fast cleaning because of the smooth surface
- Suitable for high pressure steam cleaning
- Resistant against chemical cleaning supplies
- High flexible

Note

Suitable connection glands:
LT-FG-Clean (up to M50), LT-straight,
LT-angled, LT-E-UI-straight, LT-E-UI-angled

Technical data

Protection class: IP 67 - in conjunction with the suitable tube connectors

Temperature range: -20°C up to +60°C
Temperature range temporary up to +80°C

Part no. blue	Trade size inch	Inner Ø mm	Outer Ø mm	Bending radius static	Bending radius dynamic	Unit	Net EUR/100 items at a purchase of		
							up to 100	101 - 500	501 - 1000
908211	3/8	12,6	17,8	70	100	30	o. r.	o. r.	o. r.
908212	1/2	16,0	21,1	100	135	30	o. r.	o. r.	o. r.
908213	3/4	21,1	26,4	130	175	30	o. r.	o. r.	o. r.
908214	1	26,8	33,1	180	220	30	o. r.	o. r.	o. r.
908215	1 1/4	35,4	41,8	225	270	15	o. r.	o. r.	o. r.
908216	1 1/2	40,3	47,8	255	320	15	o. r.	o. r.	o. r.
908217	2	51,6	59,9	310	400	15	o. r.	o. r.	o. r.

Dimensions and specifications may be changed without prior notice.

o. r. = on request

CV Compact Conduit gland - straight

Brass



Conduit gland CV Compact straight

Brass nickel-plated conduit gland.

Application

- Plant and machine construction
- Robotics
- Automation technology
- Vehicle construction and shipbuilding
- Railway technology
- Installation technology
- Control cabinet construction

Material

Brass, nickel plated
Grounding sleeve: Steel
Seal: Polyamide

Technical data

Protection class: IP 67

Temperature range: -45°C up to +105°C

Note

Suitable for metallic protection tubes:
EF, HTDL, OR, HC, HXC, ZHLS, HFX

Metric thread

Part no.	Size Metric	Suitable for tube ND	Suitable for tube outer Ø mm	Spanner size mm	Thread length mm	Unit	Net EUR/100 items at a purchase of		
							up to 100	101 - 500	501 - 1000
908473	M16 x 1,5	3/8	12,6	26,0	10,0	10	o. r.	o. r.	o. r.
908474	M20 x 1,5	3/8	12,6	26,0	10,0	10	o. r.	o. r.	o. r.
908475	M20 x 1,5	1/2	16,1	26,0	10,0	10	o. r.	o. r.	o. r.
908476	M25 x 1,5	3/4	21,1	35,0	10,0	5	o. r.	o. r.	o. r.
908477	M32 x 1,5	1	26,8	45,0	12,0	5	o. r.	o. r.	o. r.
908478	M40 x 1,5	1 1/4	35,4	53,0	13,0	2	o. r.	o. r.	o. r.
908479	M50 x 1,5	1 1/2	40,3	62,0	14,0	2	o. r.	o. r.	o. r.
908480	M63 x 1,5	2	51,6	76,0	16,0	2	o. r.	o. r.	o. r.

Dimensions and specifications may be changed without prior notice.

o. r. = on request

CV Compact Conduit gland - 90°



Brass



Conduit gland CV Compact 90°

Brass nickel-plated conduit gland.

Application

- Plant and machine construction
- Robotics
- Automation technology
- Vehicle construction and shipbuilding
- Railway technology
- Installation technology
- Control cabinet construction

Material

Brass, nickel plated
Grounding sleeve: Steel
Seal: Polyamide

Note

Suitable for metallic protection tubes:
EF, HTDL, OR, HC, HCX, ZHLS, HFX

Technical data

Protection class: IP 67

Temperature range: -45°C up to +105°C

Metric thread

Part no.	Size Metric	Suitable for tube ND	Suitable for tube outer Ø mm	Spanner size mm	Thread length mm	Unit	Net EUR/ 100 items at a purchase of		
							up to 100	101 - 500	501 - 1000
908481	M16 x 1,5	3/8	12,6	26,0	10,0	10	o. r.	o. r.	o. r.
908482	M20 x 1,5	3/8	12,6	26,0	10,0	10	o. r.	o. r.	o. r.
908483	M20 x 1,5	1/2	16,1	29,0	10,0	10	o. r.	o. r.	o. r.
908484	M25 x 1,5	3/4	21,1	35,0	10,0	5	o. r.	o. r.	o. r.
908485	M32 x 1,5	1	26,8	45,0	12,0	5	o. r.	o. r.	o. r.
908486	M40 x 1,5	1 1/4	35,4	53,0	13,0	2	o. r.	o. r.	o. r.
908487	M50 x 1,5	1 1/2	40,3	62,0	14,0	2	o. r.	o. r.	o. r.
908488	M63 x 1,5	2	51,6	76,0	16,0	2	o. r.	o. r.	o. r.

Dimensions and specifications may be changed without prior notice.

o. r. = on request



Conduit gland LT straight

LIQUIDTIGHT gland for plastic-coated metallic protection tubes and high temperature protection tubes HTP (An additional clamping ring is required). UL/CSA approval. The conical earthing sleeve offers maximum surface contact for optimum sealing and earthing.

Application

- Plant and machine construction
- Robotics
- Automation technology
- Vehicle construction and shipbuilding
- Railway technology
- Installation technology
- Control cabinet construction

Material

Brass, nickel plated
Grounding sleeve: Steel
Seal: Polyamide

Properties

- Halogen-free

Note

Suitable for metallic protection tubes: EF, HTDL, OR, HC, HCX, ZHLS, HFX

Technical data

Protection class: IP 67

Temperature range: -45°C up to +105°C

Metric thread

Part no.	Size Metric	Suitable for tube ND	Suitable for tube outer Ø mm	Spanner size mm	Thread length mm	Unit	Net EUR/100 items at a purchase of		
							up to 100	101 - 500	501 - 1000
94151	M16 x 1,5	3/8"	17,8	26,0	13,0	50	o. r.	o. r.	o. r.
94152	M20 x 1,5	1/2"	21,1	29,0	14,0	50	o. r.	o. r.	o. r.
94153	M25 x 1,5	3/4"	26,4	35,0	14,0	25	o. r.	o. r.	o. r.
94154	M32 x 1,5	1"	33,1	45,0	16,0	10	o. r.	o. r.	o. r.
94155	M40 x 1,5	1 1/4"	41,8	54,0	18,0	5	o. r.	o. r.	o. r.
94156	M50 x 1,5	1 1/2"	47,8	63,0	23,0	5	o. r.	o. r.	o. r.
920522	M63 x 1,5	2"	59,9	77,0	26,0	4	o. r.	o. r.	o. r.

PG thread

Part no.	Size PG	Suitable for tube ND	Suitable for tube outer Ø mm	Spanner size mm	Thread length mm	Unit	Net EUR/100 items at a purchase of		
							up to 100	101 - 500	501 - 1000
91006	11	3/8"	17,8	26,0	13,0	50	o. r.	o. r.	o. r.
91007	13,5	3/8"	17,8	26,0	13,0	50	o. r.	o. r.	o. r.
91008	16	1/2"	21,1	29,0	14,0	50	o. r.	o. r.	o. r.
91009	21	3/4"	26,4	35,0	14,0	25	o. r.	o. r.	o. r.
91010	29	1"	33,1	45,0	16,0	10	o. r.	o. r.	o. r.
91011	36	1 1/4"	41,8	54,0	18,0	5	o. r.	o. r.	o. r.
91012	42	1 1/2"	47,8	63,0	23,0	5	o. r.	o. r.	o. r.
91013	48	2"	59,9	77,0	26,0	4	o. r.	o. r.	o. r.

Continuation ►

LT Conduit gland - straight



NPT thread

Part no.	Size NPT	Suitable for tube ND	Suitable for tube outer Ø mm	Spanner size mm	Thread length mm	Unit	Net EUR/100 items at a purchase of		
							up to 100	101 - 500	501 - 1000
905749	1/2"	3/8"	17,8	26,0	12,0	50	o. r.	o. r.	o. r.
905750	1/2"	1/2"	21,1	29,0	13,0	50	o. r.	o. r.	o. r.
905751	3/4"	3/4"	26,4	35,0	15,0	25	o. r.	o. r.	o. r.
905752	1"	1"	33,1	45,0	15,0	10	o. r.	o. r.	o. r.
905753	1 1/4"	1 1/4"	49,0	54,0	16,0	5	o. r.	o. r.	o. r.
905754	1 1/2"	1 1/2"	61,0	63,0	18,0	5	o. r.	o. r.	o. r.
905755	2"	2"	66,0	77,0	20,0	4	o. r.	o. r.	o. r.

Dimensions and specifications may be changed without prior notice.

o. r. = on request



Conduit gland LT 45°

LIQUIDTIGHT gland for plastic-coated metallic protection tubes and high temperature protection tubes HTP. (An additional clamping ring is required). UL/CSA approval. The conical earthing sleeve offers maximum surface contact for optimum sealing and earthing.

Application

- Plant and machine construction
- Robotics
- Automation technology
- Vehicle construction and shipbuilding
- Railway technology
- Installation technology
- Control cabinet construction

Material

Brass, nickel plated
Grounding sleeve: Steel
Seal: Polyamide

Properties

- Halogen-free

Note

Suitable for metallic protection tubes:
EF, HTDL, OR, HC, HCX, ZHLS, HFX

Technical data

Protection class: IP 67

Temperature range: -45°C up to +105°C

Metric thread

Part no.	Size Metric	Suitable for tube ND	Suitable for tube outer Ø mm	Spanner size mm	Thread length mm	Unit	Net EUR/100 items at a purchase of		
							up to 100	101 - 500	501 - 1000
94160	M16 x 1,5	3/8"	17,8	26,0	13,0	50	o. r.	o. r.	o. r.
94161	M20 x 1,5	1/2"	21,1	29,0	14,0	50	o. r.	o. r.	o. r.
94162	M25 x 1,5	3/4"	26,4	35,0	14,0	25	o. r.	o. r.	o. r.
94163	M32 x 1,5	1"	33,1	45,0	16,0	10	o. r.	o. r.	o. r.
920526	M40 x 1,5	1 1/4"	41,8	54,0	18,0	5	o. r.	o. r.	o. r.
920527	M50 x 1,5	1 1/2"	47,8	63,0	23,0	5	o. r.	o. r.	o. r.
920528	M63 x 1,5	2"	59,9	77,0	26,0	4	o. r.	o. r.	o. r.

PG thread

Part no.	Size PG	Suitable for tube ND	Suitable for tube outer Ø mm	Spanner size mm	Thread length mm	Unit	Net EUR/100 items at a purchase of		
							up to 100	101 - 500	501 - 1000
91014	11	3/8"	17,8	26,0	16,0	50	o. r.	o. r.	o. r.
91015	13,5	3/8"	17,8	26,0	16,0	50	o. r.	o. r.	o. r.
91016	16	1/2"	21,1	29,0	16,0	50	o. r.	o. r.	o. r.
91017	21	3/4"	26,4	35,0	16,0	25	o. r.	o. r.	o. r.
91018	29	1"	33,1	45,0	19,0	10	o. r.	o. r.	o. r.
91019	36	1 1/4"	41,8	54,0	16,0	5	o. r.	o. r.	o. r.
91020	42	1 1/2"	47,8	63,0	16,0	5	o. r.	o. r.	o. r.
91021	48	2"	59,9	77,0	18,0	4	o. r.	o. r.	o. r.

Continuation ►

LT Conduit gland - 45°



NPT thread

Part no.	Size NPT	Suitable for tube ND	Suitable for tube outer Ø mm	Spanner size mm	Thread length mm	Unit	Net EUR/100 items at a purchase of		
							up to 100	101 - 500	501 - 1000
905756	1/2"	3/8"	17,8	26,0	12,0	50	o. r.	o. r.	o. r.
905757	1/2"	1/2"	21,1	29,0	13,0	50	o. r.	o. r.	o. r.
905758	3/4"	3/4"	26,4	35,0	15,0	25	o. r.	o. r.	o. r.
905759	1"	1"	33,1	45,0	15,0	10	o. r.	o. r.	o. r.
905760	1 1/4"	1 1/4"	49,0	54,0	16,0	5	o. r.	o. r.	o. r.
905761	1 1/2"	1 1/2"	61,0	63,0	18,0	5	o. r.	o. r.	o. r.
905762	2"	2"	66,0	77,0	20,0	4	o. r.	o. r.	o. r.

Dimensions and specifications may be changed without prior notice.

o. r. = on request



Conduit gland LT 90°

LIQUIDTIGHT gland for plastic-coated metallic protection tubes and high temperature protection tubes HTP. (An additional clamping ring is required). UL/CSA approval. The conical earthing sleeve offers maximum surface contact for optimum sealing and earthing.

Application

- Plant and machine construction
- Robotics
- Automation technology
- Vehicle construction and shipbuilding
- Railway technology
- Installation technology
- Control cabinet construction

Material

Brass, nickel plated
Grounding sleeve: Steel
Seal: Polyamide

Properties

- Halogen-free

Note

Suitable for metallic protection tubes:
EF, HTDL, OR, HC, HCX, ZHLS, HFX

Technical data

Protection class: IP 67

Temperature range: -45°C up to +105°C

Metric thread

Part no.	Size Metric	Suitable for tube ND	Suitable for tube outer Ø mm	Spanner size mm	Thread length mm	Unit	Net EUR/100 items at a purchase of		
							up to 100	101 - 500	501 - 1000
94170	M16 x 1,5	3/8"	17,8	26,0	13,0	50	o. r.	o. r.	o. r.
94171	M20 x 1,5	1/2"	21,1	29,0	14,0	50	o. r.	o. r.	o. r.
94172	M25 x 1,5	3/4"	26,4	35,0	14,0	25	o. r.	o. r.	o. r.
94173	M32 x 1,5	1"	33,1	45,0	16,0	10	o. r.	o. r.	o. r.
920523	M40 x 1,5	1 1/4"	41,8	54,0	18,0	5	o. r.	o. r.	o. r.
920524	M50 x 1,5	1 1/2"	47,8	63,0	23,0	5	o. r.	o. r.	o. r.
920525	M63 x 1,5	2"	59,9	77,0	26,0	4	o. r.	o. r.	o. r.

PG thread

Part no.	Size PG	Suitable for tube ND	Suitable for tube outer Ø mm	Spanner size mm	Thread length mm	Unit	Net EUR/100 items at a purchase of		
							up to 100	101 - 500	501 - 1000
91022	11	3/8"	17,8	26,0	13,0	50	o. r.	o. r.	o. r.
91023	13,5	3/8"	17,8	26,0	13,0	50	o. r.	o. r.	o. r.
91024	16	1/2"	21,1	29,0	14,0	50	o. r.	o. r.	o. r.
91025	21	3/4"	26,4	35,0	14,0	25	o. r.	o. r.	o. r.
91026	29	1"	33,1	45,0	16,0	10	o. r.	o. r.	o. r.
91027	36	1 1/4"	41,8	54,0	18,0	5	o. r.	o. r.	o. r.
91028	42	1 1/2"	47,8	63,0	23,0	5	o. r.	o. r.	o. r.
91029	48	2"	59,9	77,0	26,0	4	o. r.	o. r.	o. r.

Continuation ►

LT Conduit gland - 90°



NPT thread

Part no.	Size NPT	Suitable for tube ND	Suitable for tube outer Ø mm	Spanner size mm	Thread length mm	Unit	Net EUR/100 items at a purchase of		
							up to 100	101 - 500	501 - 1000
905763	1/2"	3/8"	17,8	26,0	12,0	50	o. r.	o. r.	o. r.
905764	1/2"	1/2"	21,1	29,0	13,0	50	o. r.	o. r.	o. r.
905765	3/4"	3/4"	26,4	35,0	15,0	25	o. r.	o. r.	o. r.
905766	1"	1"	33,1	45,0	15,0	10	o. r.	o. r.	o. r.
905767	1 1/4"	1 1/4"	49,0	54,0	16,0	5	o. r.	o. r.	o. r.
905768	1 1/2"	1 1/2"	36,8	63,0	18,0	5	o. r.	o. r.	o. r.
905769	2"	2"	66,0	77,0	20,0	4	o. r.	o. r.	o. r.

Dimensions and specifications may be changed without prior notice.

o. r. = on request



T&B straight

Conduit gland for Anaconda protection tubes. The specific construction prevents the tubes becoming deformed during assembly.

Material

Galvanized steel chromate finish
Grounding sleeve: Steel
Seal: Polyamide

Technical data

Protection class: IP 67

Application

- Plant and machine construction
- Robotics
- Automation technology
- Vehicle construction and shipbuilding
- Railway technology
- Installation technology
- Control cabinet construction

Metric thread

Part no.	Size Metric	Suitable for tube ND	Suitable for tube outer Ø mm	Spanner size mm	Thread length mm	Unit	Net EUR/100 items at a purchase of		
							up to 100	101 - 500	501 - 1000
98173	M16 x 1,5	1/4"	11,5	22,0	12,0	25	o. r.	o. r.	o. r.
98174	M20 x 1,5	1/4"	11,5	22,0	12,0	25	o. r.	o. r.	o. r.
98171	M16 x 1,5	5/16"	14,4	22,0	12,0	25	o. r.	o. r.	o. r.
98172	M20 x 1,5	5/16"	14,4	22,0	12,0	25	o. r.	o. r.	o. r.
98175	M16 x 1,5	3/8"	17,8	29,0	16,0	25	o. r.	o. r.	o. r.
98176	M20 x 1,5	3/8"	17,8	29,0	16,0	25	o. r.	o. r.	o. r.
98177	M20 x 1,5	1/2"	21,1	35,0	16,0	25	o. r.	o. r.	o. r.
98178	M25 x 1,5	3/4"	26,4	42,0	16,0	25	o. r.	o. r.	o. r.
98179	M32 x 1,5	1"	33,1	47,0	15,0	5	o. r.	o. r.	o. r.

PG thread

Part no.	Size PG	Suitable for tube ND	Suitable for tube outer Ø mm	Spanner size mm	Thread length mm	Unit	Net EUR/100 items at a purchase of		
							up to 100	101 - 500	501 - 1000
90684	9	5/16"	14,4	26,0	12,0	25	o. r.	o. r.	o. r.
90685	11	3/8"	17,8	29,0	14,0	25	o. r.	o. r.	o. r.
90686	13,5	3/8"	17,8	29,0	14,0	25	o. r.	o. r.	o. r.
90687	16	1/2"	21,1	35,0	14,0	25	o. r.	o. r.	o. r.
90688	21	3/4"	26,4	42,0	14,0	25	o. r.	o. r.	o. r.
90689	29	1"	33,1	47,0	19,0	5	o. r.	o. r.	o. r.
90690	36	1 1/4"	41,8	58,0	21,0	5	o. r.	o. r.	o. r.
90691	42	1 1/2"	47,8	69,0	21,0	2	o. r.	o. r.	o. r.
90692	48	2"	59,9	83,0	21,0	1	o. r.	o. r.	o. r.

Continuation ►

T&B Conduit gland - straight



NPT thread

Part no.	Size NPT	Suitable for tube ND	Suitable for tube outer Ø mm	Spanner size mm	Thread length mm	Unit	Net EUR/100 items at a purchase of		
							up to 100	101 - 500	501 - 1000
98190	1/4"	1/4"	11,5	21,0	12,0	25	o. r.	o. r.	o. r.
98191	3/8"	5/16"	14,4	25,0	12,0	25	o. r.	o. r.	o. r.
96737	1/2"	3/8"	17,8	29,0	14,0	25	o. r.	o. r.	o. r.
90810	1/2"	1/2"	21,1	35,0	14,0	25	o. r.	o. r.	o. r.
96465	3/4"	3/4"	26,4	42,0	14,0	25	o. r.	o. r.	o. r.
96205	1"	1"	33,1	48,0	19,0	10	o. r.	o. r.	o. r.
98192	1 1/4"	1 1/4"	41,8	58,0	21,0	5	o. r.	o. r.	o. r.
96206	1 1/2"	1 1/2"	47,8	69,0	21,0	2	o. r.	o. r.	o. r.
96207	2"	2"	59,9	83,0	22,0	1	o. r.	o. r.	o. r.

Dimensions and specifications may be changed without prior notice.

o. r. = on request



T&B 45° angled

Conduit gland for Anaconda protection tubes. The specific construction prevents the tubes becoming deformed during assembly.

Material

Galvanized steel chromate finish
Grounding sleeve: Steel
Seal: Polyamide

Technical data

Protection class: IP 67

Application

- Plant and machine construction, Automation and installation technology, Vehicle construction and shipbuilding

Metric thread

Part no.	Type	Size Metric	Suitable for tube ND	Suitable for tube outer Ø mm	Thread length mm	Spanner size mm	Unit	Net EUR/100 items at a purchase of		
								up to 100	101 - 500	501 - 1000
98180	9340	M16 x 1,5	3/8"	17,8	16,0	28,0	25	o. r.	o. r.	o. r.
98181	9341	M20 x 1,5	3/8"	17,8	16,0	28,0	25	o. r.	o. r.	o. r.
98182	9342	M20 x 1,5	1/2"	21,1	16,0	34,0	25	o. r.	o. r.	o. r.
98183	9343	M25 x 1,5	3/4"	26,4	16,0	42,0	10	o. r.	o. r.	o. r.
98184	9344	M32 x 1,5	1"	33,1	23,0	47,0	5	o. r.	o. r.	o. r.

PG thread

Part no.	Type	Size PG	Suitable for tube ND	Suitable for tube outer Ø mm	Thread length mm	Spanner size mm	Unit	Net EUR/100 items at a purchase of		
								up to 100	101 - 500	501 - 1000
90693	7341	11	3/8"	17,8	14,0	29,0	25	o. r.	o. r.	o. r.
90694	7342	13,5	3/8"	17,8	14,0	29,0	25	o. r.	o. r.	o. r.
90695	7343	16	1/2"	21,1	14,0	35,0	25	o. r.	o. r.	o. r.
90696	7344	21	3/4"	26,4	14,0	42,0	5	o. r.	o. r.	o. r.
90697	7345	29	1"	33,1	21,0	47,0	5	o. r.	o. r.	o. r.
90698	7346	36	1 1/4"	41,8	21,0	58,0	5	o. r.	o. r.	o. r.
90699	7347	42	1 1/2"	47,8	21,0	69,0	2	o. r.	o. r.	o. r.
90700	7348	48	2"	59,9	24,0	83,0	1	o. r.	o. r.	o. r.

NPT thread

Part no.	Type	Size NPT	Suitable for tube ND	Suitable for tube outer Ø mm	Thread length mm	Spanner size mm	Unit	Net EUR/100 items at a purchase of		
								up to 100	101 - 500	501 - 1000
96739	5341	1/2"	3/8"	17,8	14,0	29,0	25	o. r.	o. r.	o. r.
96208	5342	1/2"	1/2"	21,1	14,0	35,0	25	o. r.	o. r.	o. r.
96209	5343	3/4"	3/4"	26,4	14,0	42,0	10	o. r.	o. r.	o. r.
96210	5344	1"	1"	33,1	19,0	48,0	5	o. r.	o. r.	o. r.
98196	5345	1 1/4"	1 1/4"	41,8	21,0	58,0	5	o. r.	o. r.	o. r.
98197	5346	1 1/2"	1 1/2"	47,8	21,0	69,0	2	o. r.	o. r.	o. r.
96211	5347	2"	2"	59,9	22,0	83,0	1	o. r.	o. r.	o. r.

Dimensions and specifications may be changed without prior notice.

o. r. = on request



T&B 90° angled

Conduit gland for Anaconda protection tubes. The specific construction prevents the tubes becoming deformed during assembly.

Material

Galvanized steel chromate finish
Grounding sleeve: Steel
Seal: Polyamide

Technical data

Protection class: IP 67

Application

- Plant and machine construction
- Robotics
- Automation technology
- Vehicle construction and shipbuilding
- Railway technology
- Installation technology
- Control cabinet construction

Metric thread

Part no.	Type	Size Metric	Suitable for tube ND	Suitable for tube outer Ø mm	Thread length mm	Spanner size mm	Unit	Net EUR/ 100 items at a purchase of		
								up to 100	101 - 500	501 - 1000
98185	9350	M16 x 1,5	3/8"	17,8	16,0	28,0	25	o. r.	o. r.	o. r.
98186	9351	M20 x 1,5	3/8"	17,8	16,0	28,0	25	o. r.	o. r.	o. r.
98187	9352	M20 x 1,5	1/2"	21,1	16,0	34,0	25	o. r.	o. r.	o. r.
98188	9353	M25 x 1,5	3/4"	26,4	16,0	42,0	10	o. r.	o. r.	o. r.
98189	9354	M32 x 1,5	1"	33,1	23,0	47,0	5	o. r.	o. r.	o. r.

PG thread

Part no.	Type	Size PG	Suitable for tube ND	Suitable for tube outer Ø mm	Thread length mm	Spanner size mm	Unit	Net EUR/ 100 items at a purchase of		
								up to 100	101 - 500	501 - 1000
90701	7351	11	3/8"	17,8	14,0	29,0	25	o. r.	o. r.	o. r.
90702	7352	13,5	3/8"	17,8	14,0	29,0	25	o. r.	o. r.	o. r.
90703	7353	16	1/2"	21,1	14,0	35,0	25	o. r.	o. r.	o. r.
90704	7354	21	3/4"	26,4	14,0	42,0	5	o. r.	o. r.	o. r.
90705	7355	29	1"	33,1	21,0	47,0	5	o. r.	o. r.	o. r.
90706	7356	36	1 1/4"	41,8	21,0	58,0	5	o. r.	o. r.	o. r.
90707	7357	42	1 1/2"	47,8	21,0	69,0	2	o. r.	o. r.	o. r.
90708	7358	48	2"	59,9	24,0	83,0	1	o. r.	o. r.	o. r.

Continuation ►

T&B Conduit gland - 90°



NPT thread

Part no.	Type	Size NPT	Suitable for tube ND	Suitable for tube outer Ø mm	Thread length mm	Spanner size mm	Unit	Net EUR/100 items at a purchase of		
								up to 100	101 - 500	501 - 1000
97300	5351	1/2"	3/8"	17,8	14,0	29,0	25	o. r.	o. r.	o. r.
96212	5352	1/2"	1/2"	21,1	14,0	35,0	25	o. r.	o. r.	o. r.
96213	5353	3/4"	3/4"	26,4	14,0	42,0	10	o. r.	o. r.	o. r.
97671	5354	1"	1"	33,1	19,0	48,0	5	o. r.	o. r.	o. r.
98291	5355	1 1/4"	1 1/4"	41,8	21,0	58,0	5	o. r.	o. r.	o. r.
96214	5356	1 1/2"	1 1/2"	47,8	21,0	69,0	5	o. r.	o. r.	o. r.
96215	5357	2"	2"	59,9	22,0	83,0	2	o. r.	o. r.	o. r.

Dimensions and specifications may be changed without prior notice.

o. r. = on request

LT-CNP Conduit gland

For Anaconda Sealtite® CNP



Conduit gland LT-CNP straight

LIQUIDTIGHT gland made of galvanized steel for plastic-coated metallic protection tubes CNP.

Application

- Plant and machine construction
- Robotics
- Automation technology
- Vehicle construction and shipbuilding
- Railway technology
- Installation technology
- Control cabinet construction

Material

Galvanized steel

Note

UL/CSA approval
The ferrule and insert are from PA 6

Technical data

Protection class: IP 67

Temperature range: -45°C up to +105°C

NPT thread

Part no.	Type	Size NPT	Suitable for tube ND	Suitable for tube outer Ø mm	Thread length mm	Spanner size mm	Unit	Net EUR/ 100 items at a purchase of		
								up to 100	101 - 500	501 - 1000
904907	-	1/2"	3/8	19,4	15,0	27,0	25	o. r.	o. r.	o. r.
904908	-	1/2"	1/2	23,4	15,0	32,0	25	o. r.	o. r.	o. r.
904909	-	3/4"	3/4	29,5	15,0	39,0	25	o. r.	o. r.	o. r.
904910	-	1"	1	36,3	18,0	45,0	5	o. r.	o. r.	o. r.
904911	-	1 1/4"	1 1/4	46,0	19,0	59,0	5	o. r.	o. r.	o. r.
904912	-	1 1/2"	1 1/2	52,4	19,0	67,0	2	o. r.	o. r.	o. r.
904913	-	2"	2	66,6	19,0	82,0	1	o. r.	o. r.	o. r.

Dimensions and specifications may be changed without prior notice.

o. r. = on request

LT-CNP-E Conduit gland, stainless steel

For Anaconda Sealrite® CNP



Conduit gland LT-CNP-E straight

LIQUIDTIGHT gland made of stainless steel for plastic-coated metallic protection tubes CNP.

Application

- Plant and machine construction
- Robotics
- Automation technology
- Vehicle construction and shipbuilding
- Railway technology
- Installation technology
- Control cabinet construction

Material

Stainless steel

Note

The ferrule and insert are from PA6.

Technical data

Protection class: IP 67

Temperature range: -45°C up to +105°C

Metric thread

Part no.	Type	Size Metric	Suitable for tube ND	Suitable for tube outer Ø mm	Thread length mm	Spanner size mm	Unit	Net EUR/100 items at a purchase of		
								up to 100	101 - 500	501 - 1000
905913	-	M16 x 1,5	3/8	19,4	13,0	30,0	50	o. r.	o. r.	o. r.
905914	-	M20 x 1,5	1/2	23,4	13,0	36,0	50	o. r.	o. r.	o. r.
905058	-	M25 x 1,5	3/4	29,5	15,0	41,0	25	o. r.	o. r.	o. r.
905059	-	M32 x 1,5	1	36,3	15,0	50,0	10	o. r.	o. r.	o. r.
905060	-	M40 x 1,5	1 1/4	46,0	16,0	60,0	5	o. r.	o. r.	o. r.
905061	-	M50 x 1,5	1 1/2	52,4	19,0	66,0	5	o. r.	o. r.	o. r.
905062	-	M63 x 1,5	1 1/2	52,4	19,0	81,0	4	o. r.	o. r.	o. r.
905063	-	M63 x 1,5	2	66,6	19,0	81,0	4	o. r.	o. r.	o. r.

Dimensions and specifications may be changed without prior notice.

o. r. = on request

LT-FG-Clean Conduit gland, stainless steel



LT-FG-Clean

Highest requirements to cleanliness and cleaning.

Application

- Food industry - milk and meat products
- Packaging of food machines
- Beverage industry
- Pharmaceutical industry
- Chemical industry

Material

Housing material: Stainless steel AISI 316
 Ferrule: Brass, nickel plated
 Clamping ring and insert: PA 6
 Outer seal and sealing ring: TPE according to FDA 21 CFR and NSF 51 (USA-Norm)
 Grounding sleeve: Steel

Properties

- High corrosion resistance
- The smooth surface prevents to adhere harmful micro organisms
- Easy, fast and less expensive cleaning supplies
- No threads are exposed
- High tightness
- No enter from water and dirt from outside
- High mechanical load capacity

Technical data

Protection class: IP67 (40bar, 80°C)

Temperature range: -45°C up to +105°C

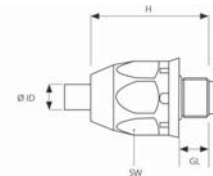

Note

Suitable protection tubes:
 Anaconda Sealtite FG-Clean, also possible EF,
 HTDL, OR, HC, HCX, ZHLS, HFX

Metric thread

Part no.	Size Metric	Suitable for tube ND	Suitable for tube outer Ø	Inner Ø	Spanner size mm	Thread length mm	Height mm	Angle size mm	Unit	Net EUR/100 items at a purchase of		
										up to 100	101 - 500	501 - 1000
906928	M16 x 1,5	3/8	17,8	10,4	27	11,5	48	31,2	50	o. r.	o. r.	o. r.
906929	M20 x 1,5	1/2	21,1	13,8	30	13,0	50	34,6	50	o. r.	o. r.	o. r.
906843	M25 x 1,5	3/4	26,4	18,5	36	15,0	57	41,6	25	o. r.	o. r.	o. r.
906844	M32 x 1,5	1	33,1	23,8	46	15,0	68	53,1	10	o. r.	o. r.	o. r.
906845	M40 x 1,5	1 1/4	41,8	31,9	54	16,0	75	62,4	5	o. r.	o. r.	o. r.
906846	M50 x 1,5	1 1/2	47,8	36,9	63	18,0	82	72,7	5	o. r.	o. r.	o. r.

Dimensions and specifications may be changed without prior notice.

o. r. = on request

EES Inner sleeve

Galvanized steel



EES

Inner sleeve EES made of galvanized steel for plastic-coated metal protection tubes type Anaconda.

Material

Galvanized steel

Technical data

Well-fitting to protection tubes: Anaconda

Note

Suitable to LT glands

EES – Galvanized steel

Part no. Anaconda	Suitable for tube outer Ø mm	Unit	Net EUR/100 items at a purchase of		
			up to 100	101 - 500	501 - 1000
96839	17,8	250	o. r.	o. r.	o. r.
97480	21,1	250	o. r.	o. r.	o. r.
96580	26,4	100	o. r.	o. r.	o. r.
96803	33,1	50	o. r.	o. r.	o. r.
96880	41,8	25	o. r.	o. r.	o. r.
98364	47,8	25	o. r.	o. r.	o. r.
905027	59,9	25	o. r.	o. r.	o. r.
905028	72,6	25	o. r.	o. r.	o. r.
905029	88,4	25	o. r.	o. r.	o. r.
905030	113,8	25	o. r.	o. r.	o. r.

Dimensions and specifications may be changed without prior notice.

o. r. = on request

HELUCHAIN

EASYLINE

MULTILINE

HEAVYLINE

SAFELINE

POWERLINE

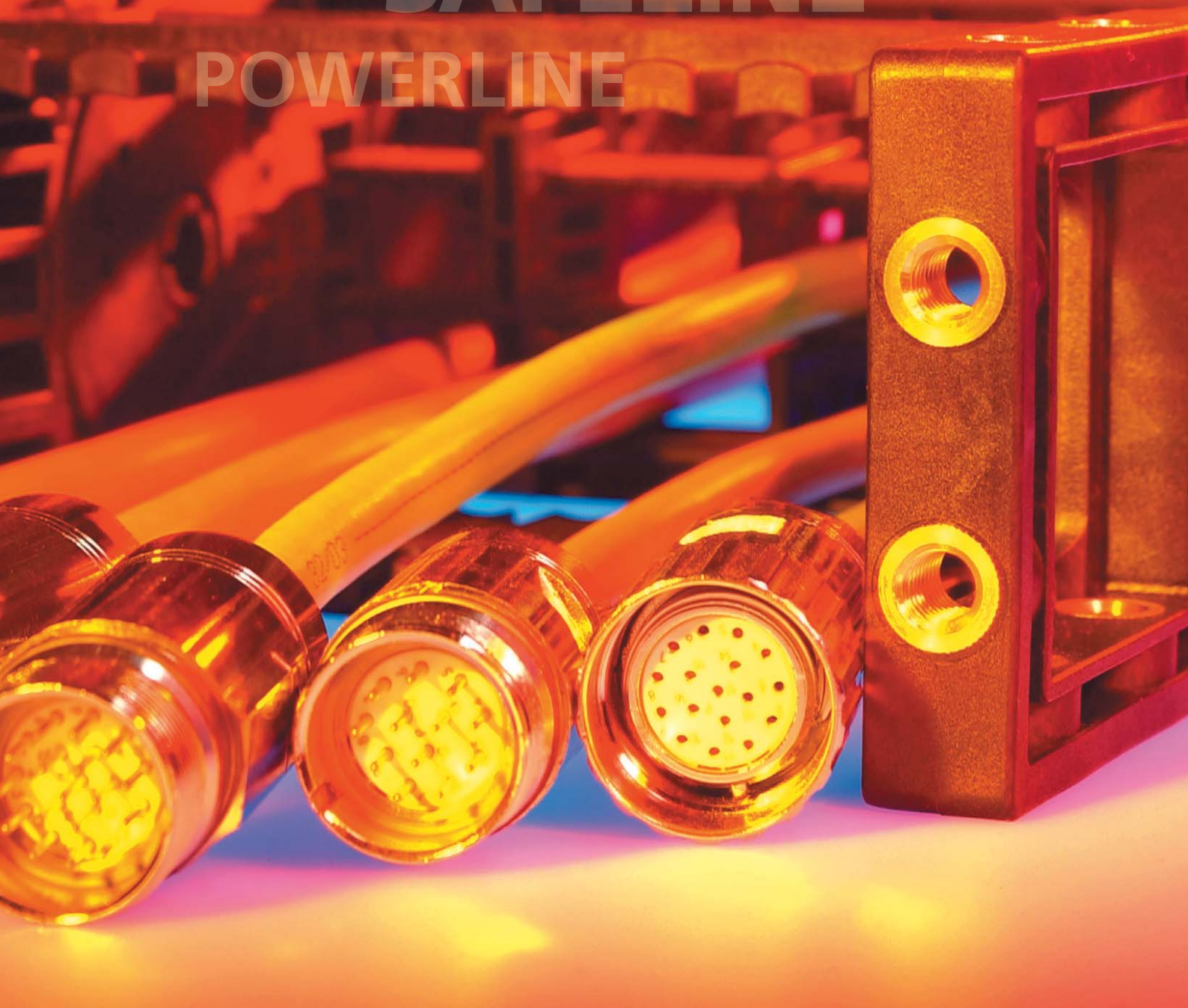

■ OVERVIEW ENERGY DRAG CHAINS

Series/Material	Application area	Item	Page
Energy drag chains			
Installation manual	Energy drag chains		286
Questionnaire	Energy drag chains		288
		EasyLine EFK 10.1	289
		MultiLine EFK 14	290
		MultiLine EFK 18.1	291
		MultiLine EFK 18.2	292
		MultiLine EFK 35	293
		MultiLine EFK 3000	294
		MultiLine EFK 44	295
		PowerLine EFK 52.2	296
		HeavyLine EFK 62.2	297
		SafeLine EFK 25G	298
		SafeLine EFK 36G	299

■ INSTALLATION MANUAL

Cable installation in drag chains

The control cables in drag chains undertake an important task for the controlling and power technique, must be good synchronized with each other in the power chain systems. Further the installation of the cables and protection tubes in the power drag

chains must be conducted with great care. Basically, please note the following:

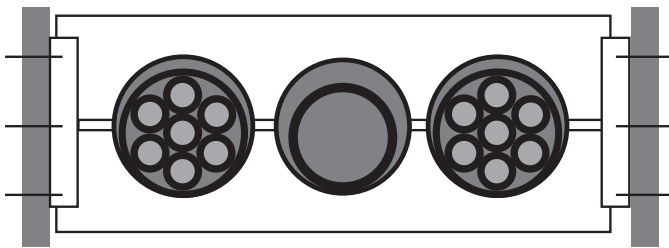

1. Cables (flat and round) should be installed separately next to another. Separators should be placed between the cables next to each other. Please avoid to place different sizes of round cables with higher differences in cable diameters next to each other. If it is not possible to install cables on top of each other, due to the limited space, please install separators.

2. The cables must move freely in the chain web. The free space for the cables should be at least 10 % of the cable diameter.

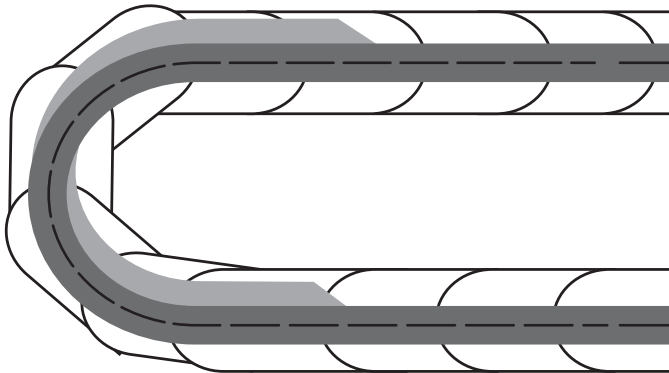

3. Always ensure that the cable runs through the radius of curvature without problems.

If the cables should be installed in the drag chain in layers then it is important to check that there is enough space in the curvature.

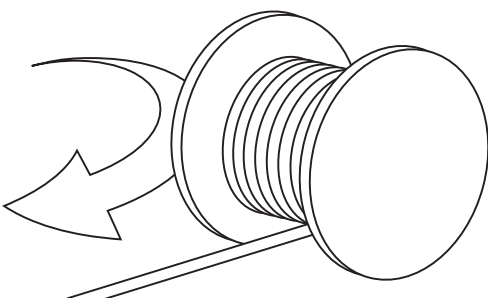

5. Cables should always be installed free of twists into the drag chains. The cables must be reeled down tangential from the reels or drums; the cables should not be lifted up in twisted or looping form over head. The cables must be laid in straight and non-twisted form on plane surface before installation. The cables must have an additional length of at least 10% of the whole length so that these can be laid freely without twisting in the drag chain. Notes for a vertical installation:

The cables must have at least 20% more space within the root-face height because the cable weight including the chain is heavy and the cables could sag downwards. This drawdown should be kept in mind and must be adjusted periodically.

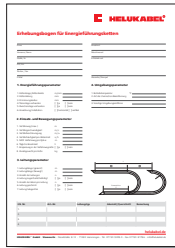

Download Questionnaire for Energy Drag Chain Systems:

You can download the questionnaire for energy drag chains simply under: www.helukabel.de/Erhebungsbogen-Energie.pdf

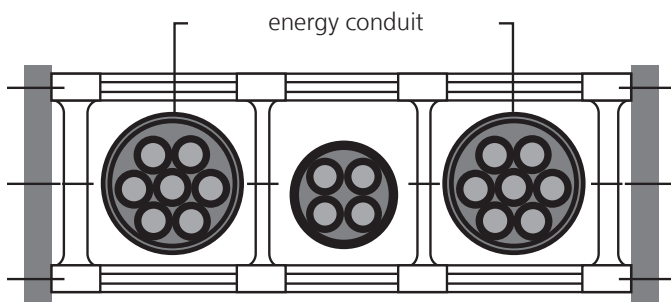

6. In case that is not possible to lay the cables as described in point 1, we recommend the use of a guiding tube, in which these cables should loosely laid when using several multi-wire highly flexible cables with a diameter < 10 mm. The cross section of the tube has to be much larger than the sum of the single cable cross sections.

7. In case that pressure- or hydraulic tubes are integrated in a power drag system, it should be guaranteed that the tubes can be freely move in the chain web due to the fact that they will shorten or stretch under alternating loads. Please contact the Cable Accessories department for further information.

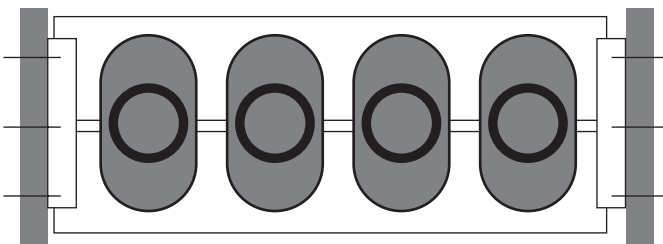

8. The weight distribution in the chain web should be symmetrical. Ensure that the weight of the cables inside is divided up evenly, with the heavier cables installed on the edges and the lighter types in the middle. The cables should be connected on both sides on strain relief, or at least at the flexible part of the drag chain. Therefore it has to be noticed, that the compression occurs on a large area so that the cable is fixed on the outer sheath. The clamping has to be proceeded so that the single cores cannot be pinched in the cable and a movement of cables is not possible. This is the only way that a necessary length compensation is possible. A distance from 20 to 30 x cable diameters between end of the bending movement and fixing should be an indicative value. Generally it is recommended, if possible, not to use cables with a multi layer construction, e.g. >25 cores, but to split the necessary number of conductors over several cables.

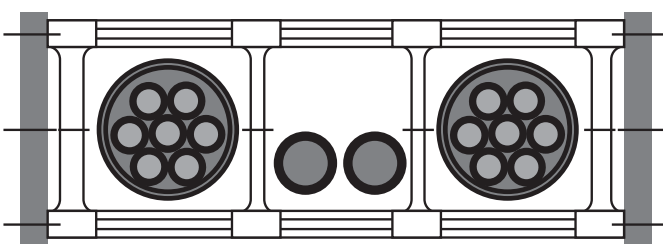

Questionnaire for energy drag chains

Company	Installation site
First name, Name	Kind of machine
Street, No.	In operation since
Postal Code, Place	
Phone / Fax	
E-Mail	Sender

1. Drag Chain-Parameter

1. Chain length/chain width m/mm _____
2. Chain pitch mm _____
3. Bending radius mm _____
4. Guide stays existing yes no
5. Frame stays existing yes no
6. Layout/Installation horizontal vertical

4. Environmental-Parameter

1. Operating temperature °C _____
2. Kind of chemical influences _____
3. Other environmental influences _____

2. Installation and Movement-Parameter

1. Movement distance (max.) m _____
2. Speeds m/s _____
3. Acceleration m/s² _____
4. Frequency per time unit x/h _____
5. Average movement distance/cycle m _____
6. Daily working duration h _____
7. Feeding at mid of moving distance yes no
8. Additional weight/chain kg _____

3. Cable-Parameter

1. Cable length (total) m _____
2. Cable length (mobile) m _____
3. Number of cables n _____
4. Cable clamping without strain yes no
5. Number of cores per cable n _____
6. Cable screened yes no
7. Cable halogen-free yes no

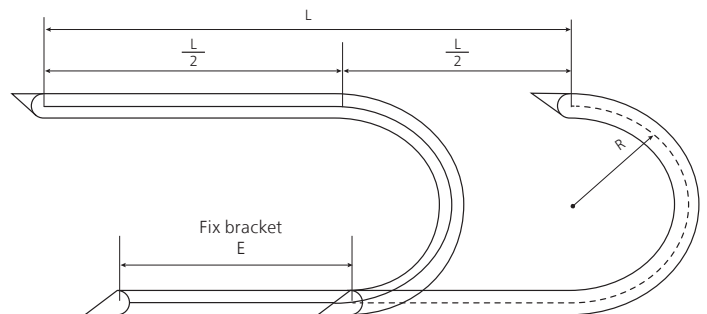

L = Movement distance
R = Radius
E = Distance between cable entrance and mid of moving distance

No.	Part-No.	Cable type	No. cores/cross-sec.	Notes
1.				
2.				
3.				
4.				

EASYLINE EFK 10.1



Technical data

- Internal height 10 mm
- Internal width 6-41 mm
- Loading side - outside bend slitted
- Links per meter: 67
- Chain pitch: 15 mm
- Maximum cable diameter: 8 mm
- Maximum movement distance: max. 10 m
- Material: Modified Polyamid

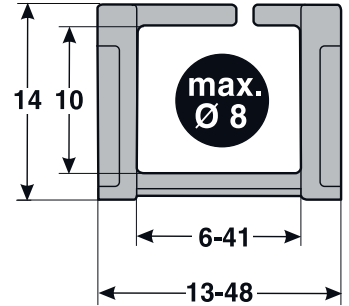

Version (order code)

Bridge version (order code)

Radius (order code) in mm

Internal width (order code) in mm

Outer width in mm

R	HS	HMA
mm	mm	mm
18	60	50
28	80	70
38	100	90
48	120	110
58	140	130

Open installation height: $HS = 2xR + HG + S$

Connection height bottom/top: $HMA = 2xR + HG$

External height chain link: $HG = 14 \text{ mm}$

Safety: $S = 10 \text{ mm}$

Pitch chain link: $T = 15 \text{ mm}$

13	6	006		
16	9	009	18	018
22	15	015	28	028
28	21	021	38	038
38	31	031	48	048
48	41	041	58	058

	0
	7
0	9

Bridge version: version:
 0 full bridge m. 0 Standard (PA)
 7 ESD (PA)
 9 special version

Order number:

0101

Example: Internal width = 6 mm, Radius = 18 mm, Bridge version = 0, Version = 0

Order number: 0101 006 018 0000

Please order per chain
 2 chain connections.
 You will automatically receive
 1 piece with bore
 and 1 piece with bolt.

Subject to technical modifications.

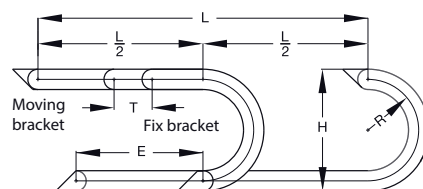

Conduit conveyance outside the middle Conduit conveyance in the middle

L = Moving distance, R = Radius,
 H = Installation height, T = Pitch,
 E = Distance between entry point and middle of movement distance

Specification of the chain length

$$\text{Length} = \frac{L}{2} + p \times R + 2 \times T + E$$

< 1 m Chain = 67 piece. Chain links à 15 mm

The fixed point of the drag chain should be in the middle of the movement distance

This arrangement gives the shortest connection between fixed point and the moving consumer and thus the most efficient chain length.

MULTILINE EFK 14



Technical data

- Internal height 14 mm
- Internal width 16-40 mm
- Loading side - outside bend
- Links per meter: 38
- Chain pitch: 26 mm
- Maximum cable diameter: 12 mm
- Maximum movement distance: max. 20 m
- Material: Modified Polyamid

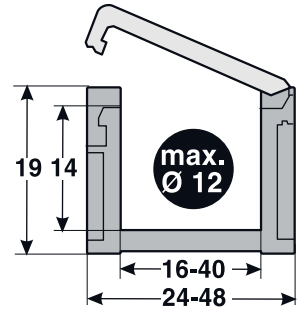

Version (order code)

Bridge version (order code)

Radius (order code) in mm

Internal width (order code) in mm

Outer width in mm

R	HS	HMA
mm	mm	mm
25	89	69
38	115	69
48	135	115
78	189	169

Open installation height: $HS = 2xR + HG + S$

Connection height bottom/top: $HMA = 2xR + HG$

External height chain link: $HG = 19 \text{ mm}$

Safety: $SK = 20 \text{ mm}$

Pitch chain link: $T = 26 \text{ mm}$

24	16	016	25	025
28	20	020	38	038
38	30	030	48	048
48	40	040	75	075

	0
	7
0	9

Bridge version: 0 full bridge m.

version:
0 Standard (PA)
7 ESD (PA)
9 special version

Order number:

0140 0 0

Example: Internal width = 16 mm, Radius = 25 mm, Bridge version = 0, Version = 0

Order number: 0140 016 025 0000

Please order per chain
2 chain connections.
You will automatically receive
1 piece with bore
and 1 piece with bolt.

Subject to technical modifications.

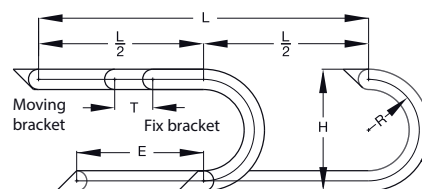

Conduit conveyance outside the middle Conduit conveyance in the middle

L = Moving distance, R = Radius,
H = Installation height, T = Pitch,
E = Distance between entry point and
middle of movement distance

Specification of the chain length

$$\text{Length} = \frac{L}{2} + p \times R + 2 \times T + E$$

< 1 m Chain = 38 piece. Chain links à 26 mm

The fixed point of the drag chain should be in the middle of the movement distance

This arrangement gives the shortest connection between fixed point and the moving consumer and thus the most efficient chain length.

MULTILINE EFK 18.1



Technical data

- Internal height 18 mm
- Internal width 18-70 mm
- Loading side - outside bend
- Links per meter: 30
- Chain pitch: 33 mm
- Maximum cable diameter: 15 mm
- Maximum movement distance: max. 30 m
- Material: Modified Polyamid

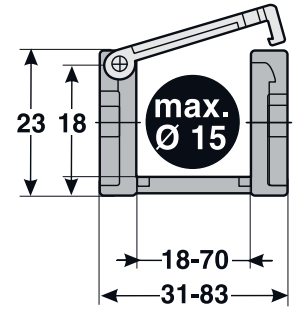

Version (order code)

Bridge version (order code)

Radius (order code) in mm

Internal width (order code) in mm

Outer width in mm

R	HS	HMA
mm	mm	mm
28	109	79
38	129	99
48	149	119
78	209	179

Open installation height: $HS = 2xR + HG + S$

Connection height bottom/top: $HMA = 2xR + HG$

External height chain link: $HG = 23$ mm

Safety: $S = 30$ mm

Pitch chain link: $T = 33$ mm

31	18	018		
38	25	025	25	028
50	37	037	38	038
63	50	050	48	048
83	70	070	78	078

	0
	7
0	9

Bridge version: 0 full bridge m.

version: 0 Standard (PA)
7 ESD (PA)
9 special version

Order number:

0181

Example: Internal width = 18 mm, Radius = 28 mm, Bridge version = 0, Version = 0

Order number: 0181 018 028 0000

Please order per chain
2 chain connections.
You will automatically receive
1 piece with bore
and 1 piece with bolt.

Prices on request

Subject to technical modifications.

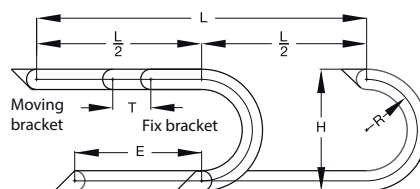

Conduit conveyance outside the middle Conduit conveyance in the middle

L = Moving distance, R = Radius,
H = Installation height, T = Pitch,
E = Distance between entry point and
middle of movement distance

Specification of the chain length

$$\text{Length} = \frac{L}{2} + p \times R + 2 \times T + E$$

< 1 m Chain = 30 piece. Chain links à 33 mm

The fixed point of the drag chain should be in the middle of the movement distance

middle of movement distance

This arrangement gives the shortest connection between fixed point and the moving consumer and thus the most efficient chain length.

MULTILINE EFK 18.2



Technical data

- Internal height 18 mm
- Internal width 18-70 mm
- Loading side - inside bend
- Links per meter: 30
- Chain pitch: 33 mm
- Maximum cable diameter: 15 mm
- Maximum movement distance: max. 30 m
- Material: Modified Polyamid

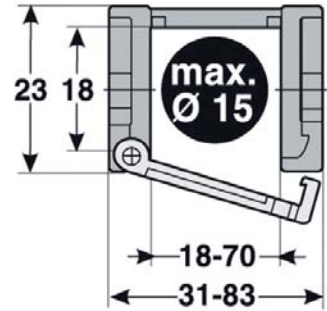

Version (order code)

Bridge version (order code)

Radius (order code) in mm

Internal width (order code) in mm

Outer width in mm

R	HS	HMA
mm	mm	mm
28	109	79
38	129	99
48	149	119
78	209	179

Open installation height: $HS = 2xR + HG + S$

Connection height bottom/top: $HMA = 2xR + HG$

External height chain link: $HG = 23 \text{ mm}$

Safety: $S = 30 \text{ mm}$

Pitch chain link: $T = 33 \text{ mm}$

31	18	018		
38	25	025	28	028
50	37	037	38	038
63	50	050	48	048
83	70	070	78	078

	0
	7
0	9

Bridge version: 0 full bridge m.

version: 0 Standard (PA)
7 ESD (PA)
9 special version

Order number:

Example: Internal width = 18 mm, Radius = 28 mm, Bridge version = 0, Version = 0

Order number: 0182 018 028 0000

Please order per chain 2 chain connections. You will automatically receive 1 piece with bore and 1 piece with bolt.

Subject to technical modifications.

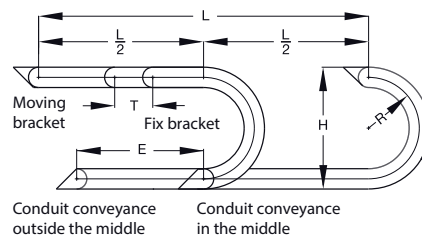

L = Moving distance, R = Radius,
 H = Installation height, T = Pitch,
 E = Distance between entry point and middle of movement distance

Specification of the chain length

$$\text{Length} = \frac{L}{2} + p \times R + 2 \times T + E$$

< 1 m Chain = 30 piece. Chain links à 33 mm

The fixed point of the drag chain should be in the middle of the movement distance

This arrangement gives the shortest connection between fixed point and the moving consumer and thus the most efficient chain length.

MULTILINE EFK 35



Technical data

- Internal height 34 mm
- Internal width 62-150 mm
- Loading side - inside bend
- Links per meter: 17
- Chain pitch: 58 mm
- Maximum cable diameter: 30 mm
- Maximum movement distance: max. 80 m
- Material: Modified Polyamid

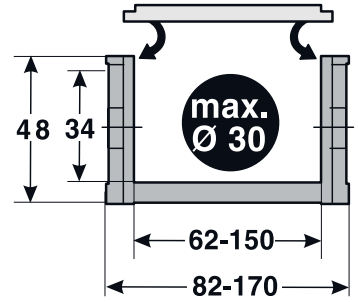

Version (order code)
Bridge version (order code)
Radius (order code) in mm
Internal width (order code) in mm
Outer width in mm

R	HSK	HSV	HMA
mm	mm	mm	mm
70	203	228	188
100	263	288	248
150	363	388	348
200	463	488	448
300	663	688	648

Open installation height: (without pre-tension) HSK = 2xR+HG+SK
 Open installation height: (without pre-tension) HSV = 2xR+HG+SV
 Connection height bottom/top: HMA = 2xR + HG
 External height pre-tension: HG = 48 mm
 Safety without pre-tension: SK = 15 mm
 Safety with pre-tension: SV = 40 mm
 Pitch chain link: T = 58 mm

82	62	062	70	070		
106	86	086	100	100		
122	102	102	150	150		
145	125	125	200	200	1	0
170	150	150	300	300	0	7
					0	9

Bridge version: version:
 0 full bridge m. 0 Standard (PA)
 Vorsp. 7 ESD (PA)
 1 full bridge m. 9 special version
 Vorsp.

Order number:

Example: Internal width = 62 mm, Radius = 70 mm, Bridge version = 0, Version = 0

Order number: 0350 062 070 0000

Please order per chain 2 chain connections. You will automatically receive 1 piece with bore and 1 piece with bolt.

Subject to technical modifications.

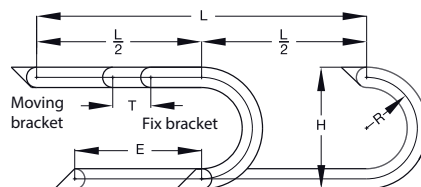

Conduit conveyance outside the middle Conduit conveyance in the middle

L = Moving distance, R = Radius,
 H = Installation height, T = Pitch,
 E = Distance between entry point and middle of movement distance

Specification of the chain length

$$\text{Length} = \frac{L}{2} + p \times R + 2 \times T + E$$

< 1 m Chain = 17 piece. Chain links à 58 mm

The fixed point of the drag chain should be in the middle of the movement distance

This arrangement gives the shortest connection between fixed point and the moving consumer and thus the most efficient chain length.

MULTILINE EFK 3000



Technical data

- Internal height 26 mm
- Internal width 26-101 mm
- Loading side - inside bend
- Links per meter: 22
- Chain pitch: 45 mm
- Maximum cable diameter: 23 mm
- Maximum movement distance: max. 60 m
- Material: Modified Polyamid

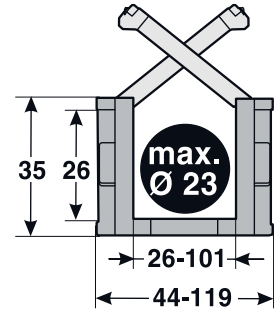

Version (order code)

Bridge version (order code)

Radius (order code) in mm

Internal width (order code) in mm

Outer width in mm

R	HSK	HSV	HMA
mm	mm	mm	mm
50	145	180	135
70	185	220	175
95	235	270	225
120	285	320	275
150	345	380	335
200	445	480	435
300	645	680	635

Open installation height: (without pre-tension) HSK = 2xR + HG + SK

Open installation height: (without pre-tension) HSV = 2xR + HG + SV

Connection height bottom/top: HMA = 2xR + HG

External height pre-tension: HG = 35 mm

Safety without pre-tension: SK = 10 mm

Safety with pre-tension: SV = 45 mm

Pitch chain link: T = 45 mm

44	26	026	50	050		
55	37	037	70	070		
74	56	056	95	095		
80	62	062	120	120		
94	76	076	150	150		
105	87	087	200	200	1	0
119	101	101	300	300	0	9

Bridge version: 0 full bridge m.
1 full bridge m.

version: 0 Standard (PA)
7 ESD (PA)
9 special version

Order number:

Example: Internal width = 26 mm, Radius = 50 mm, Bridge version = 0, Version = 0

Order number: 0300 026 050 0000

Please order per chain 2 chain connections. You will automatically receive 1 piece with bore and 1 piece with bolt.

Subject to technical modifications.

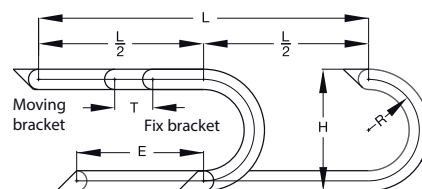

Conduit conveyance outside the middle Conduit conveyance in the middle

L = Moving distance, R = Radius,
H = Installation height, T = Pitch,
E = Distance between entry point and middle of movement distance

Specification of the chain length

$$\text{Length} = \frac{L}{2} + p \times R + 2 \times T + E$$

< 1 m Chain = 22 piece. Chain links à 45 mm

The fixed point of the drag chain should be in the middle of the movement distance middle of movement distance

This arrangement gives the shortest connection between fixed point and the moving consumer and thus the most efficient chain length.

MULTILINE EFK 44

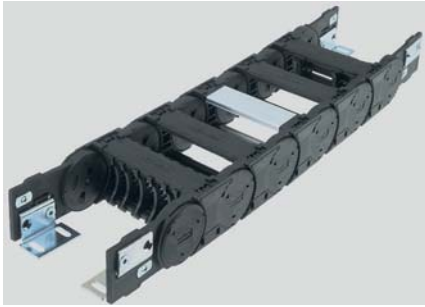

Technical data

- Internal height 40 mm
- Internal width 45-400 mm
- Loading side - inside and outside bend
- Links per meter: 13
- Chain pitch: 75.5 mm
- Maximum cable diameter: 35 mm
- Maximum movement distance: max. 50 m
- Material: Modified Polyamid

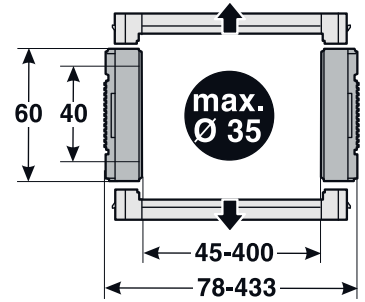

Version (order code)
Bridge version (order code)
Radius (order code) in mm
Internal width (order code) in mm
Outer width in mm

R	HSK	HSV	HMA
mm	mm	mm	mm
90	253	278	240
125	323	348	310
150	373	398	360
200	473	498	460
250	573	598	560

Open installation height: HSK = 2xR+HG+SK
(without pre-tension)
Open installation height: HSV = 2xR+HG+SV
(without pre-tension)
Connection height bottom/top: HMA = 2xR + HG

External height pre-tension: HG = 60 mm
Safety: SK = 13 mm
Safety with pre-tension: SV = 38 mm
Pitch chain link: T = 75.5 mm

78	45	045			0
95	62	062			1
117	84	084			2
138	105	105	90	090	3
177	144	144	125	125	4
215	182	182	150	150	5
Inside	118-		200	200	6
+33	600	ALU	250	250	7
					8
					9

- Bridge version: 0 Standard (PA)
0 full bridge 7 ESD (PA)
with pre-tension 9 special
1 full bridge without version
pre-tension
2 half bridge with
pre-tension
3 half bridge without
pre-tension
4 ALU full bridge
with pre-tension
5 ALU full bridge
without pre-tension

Please order per chain
2 chain connections.
You will automatically receive
1 piece with bore
and 1 piece with bolt.

Subject to technical modifications.

Order number:

0440

0

0

Example: Internal width = 45 mm, Radius = 90 mm, Bridge version = 0, Version = 0

Order number: 0440 045 090 0000

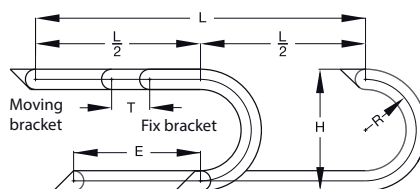

Conduit conveyance outside the middle Conduit conveyance in the middle

L = Moving distance, R = Radius,
H = Installation height, T = Pitch,
E = Distance between entry point and
middle of movement distance

Specification of the chain length

$$\text{Length} = \frac{L}{2} + p \times R + 2 \times T + E$$

< 1 m Chain = 13 piece. Chain links à 75.5 mm

The fixed point of the drag chain should be in the middle of the movement distance

This arrangement gives the shortest connection between fixed point and the moving consumer and thus the most efficient chain length.

POWERLINE EFK 52.2



Technical data

- Internal height 52 mm
- Internal width 45-546 mm
- Loading side (inside and outside bend)
- Links per meter: 11
- Chain pitch: 91 mm
- Maximum cable diameter: 45 mm
- Maximum movement distance: max. 150 m
- Material: Modified Polyamid

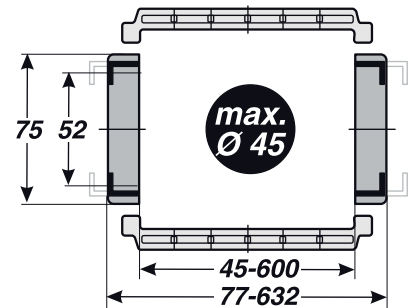

Version (order code)

Bridge version (order code)

Radius (order code) in mm

Internal width (order code) in mm

Outer width in mm

R	HSK	HSV	HMA
mm	mm	mm	mm
100	290	320	274
150	390	420	374
200	490	520	474
250	590	620	574
300	690	720	674
350	790	820	774

Open installation height: HSK = 2xR+HG+SK
(without pre-tension)

Open installation height: HSV = 2xR+HG+SV
(without pre-tension)

Connection height bottom/top: HMA = 2xR + HG

External height pre-tension: HG = 74 mm

Safety without pre-tension: SK = 16 mm

Safety with pre-tension: SV = 46 mm

Pitch chain link: T = 91 mm

77	45	045						
94	62	062						
103	71	071						
116	84	084						
128	96	096						
139	107	107						
153	121	121						
176	144	144						
178	146	146						
203	171	171						
214	182	182						
228	196	196						
252	220	220						
278	246	246						
328	296	296						
378	346	346						
428	396	396	100	100				
478	446	446	150	150				
528	496	496	200	200				
578	546	546	250	250				
Indoor	80-		300	300				
+32	600	ALU	350	350				
							0	
							1	
							2	
							3	
							4	
							5	
							6	0
							7	7
							9	9

- Bridge version: 0 Standard (PA)
- 0 full bridge with pre-tension 7 ESD (PA)
- 1 full bridge without pre-tension 9 special version
- 2 half bridge with pre-tension
- 3 half bridge without pre-tension
- 4 ALU full bridge with pre-tension
- 5 ALU full bridge without pre-tension
- 2 ALU half bridge with pre-tension
- 7 ALU half bridge without pre-tension
- 9 special version

Order number: **0522** **0** **0**

Example: Internal width = 45 mm, Radius = 100 mm, Bridge version = 0, Version = 0

Order number: **0522 045 100 0000**

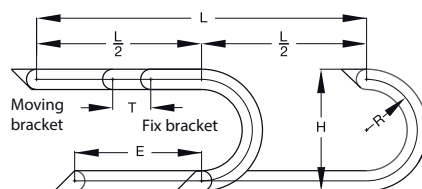

Conduit conveyance outside the middle Conduit conveyance in the middle

L = Moving distance, R = Radius,
H = Installation height, T = Pitch,
E = Distance between entry point and middle of movement distance

Specification of the chain length

$$\text{Length} = \frac{L}{2} + p \times R + 2 \times T + E$$

< 1 m Chain = 11 piece. Chain links à 91 mm

The fixed point of the drag chain should be in the middle of the movement distance

This arrangement gives the shortest connection between fixed point and the moving consumer and thus the most efficient chain length.

Please order per chain 2 chain connections. You will automatically receive 1 piece with bore and 1 piece with bolt.

Subject to technical modifications.

HEAVYLINE EFK 62.2

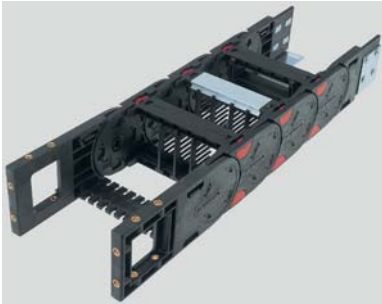

Technical data

- Internal height 62 mm
- Internal width 118-518 mm
- Loading side (inside and outside bend)
- Links per meter: 10
- Chain pitch: 100 mm
- Maximum cable diameter: 52 mm
- Maximum movement distance: max. 180 m
- Material: Modified Polyamid

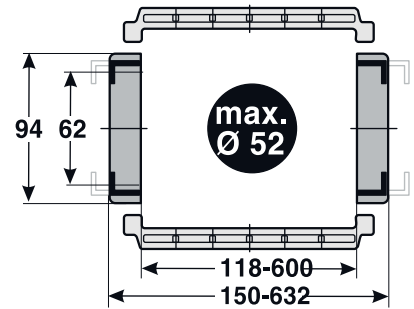

Version (order code)

Bridge version (order code)

Radius (order code) in mm

Internal width (order code) in mm

Outer width in mm

R	HSK	HSV	HMA
mm	mm	mm	mm
150	414	444	394
200	514	544	494
250	614	644	594
300	714	744	694
400	914	944	894
500	1114	1144	1094

Open installation height: HSK = 2xR+HG+SK
(without pre-tension)

Open installation height: HSV = 2xR+HG+SV
(without pre-tension)

Connection height bottom/top: HMA = 2xR + HG

External height pre-tension: HG = 94 mm

Safety without pre-tension: SK = 20 mm

Safety with pre-tension: SV = 50 mm

Pitch chain link: T = 100 mm

150	118	118							
175	143	143							
200	168	168							
225	193	193							
250	218	218							
275	243	243							
300	268	268							
325	293	293							
350	318	318							
375	343	343							
400	368	368	150	150					
450	418	418	200	200					
500	468	468	250	250					
550	518	518	300	300					
In-door	118-600	ALU	400	400					
+32			500	500					
								0	
								1	
								2	
								3	
								4	
								5	
								6	0
								7	7
								9	9

- Bridge version:
- 0 Standard (PA)
 - 7 ESD (PA)
 - 9 special version
- 1 full bridge without pre-tension
 - 2 half bridge with pre-tension
 - 3 half bridge without pre-tension
 - 4 ALU full bridge with pre-tension
 - 5 ALU full bridge without pre-tension
 - 6 ALU half bridge with pre-tension
 - 7 ALU half bridge without pre-tension
 - 9 special version

Order number:

0622 [] [] [] [] [] [] [] [] [] []

Example: Internal width = 118 mm, Radius = 150 mm, Bridge version = 0, Version = 0

Order number: 0622 118 150 0000

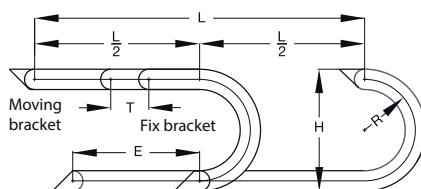

Conduit conveyance outside the middle Conduit conveyance in the middle

L = Moving distance, R = Radius,
H = Installation height, T = Pitch,
E = Distance between entry point and middle of movement distance

Specification of the chain length

$$\text{Length} = \frac{L}{2} + p \times R + 2 \times T + E$$

< 1 m Chain = 10 piece. Chain links à 100 mm

The fixed point of the drag chain should be in the middle of the movement distance

This arrangement gives the shortest connection between fixed point and the moving consumer and thus the most efficient chain length.

Please order per chain 2 chain connections. You will automatically receive 1 piece with bore and 1 piece with bolt.

Subject to technical modifications.

SAFELINE EFK 25G



Technical data

- Internal height 25 mm
- Internal width 26-125 mm
- Loading side - inside bend
- Links per meter: 33
- Chain pitch: 30 mm
- Maximum cable diameter: 22 mm
- Maximum movement distance: max. 40 m
- Material: Modified Polyamid

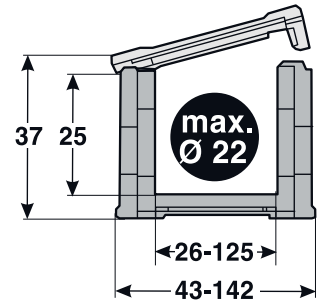

Version (order code)
Bridge version (order code)
Radius (order code) in mm
Internal width (order code) in mm
Outer width in mm

R	HS	HMA
mm	mm	mm
60	190	157
75	220	187
100	270	237
125	320	287
150	370	337
200	470	437
250	570	537

Open installation height: $HS = 2xR + HG + S$
 Connection height bottom/top: $HMA = 2xR + HG$
 External height pre-tension: $HG = 37$ mm
 Safety: $S = 33$ mm
 Pitch chain link: $T = 30$ mm

44	26	026	60	060		
55	37	037	75	075		
80	62	062	125	125		
105	87	087	150	150		
119	101	101	200	200		
143	125	125	250	250		
					0	0
						9

Bridge version: version:
 0 full bridge m. 0 Standard (PA)
 pre-tension 7 ESD (PA)
 9 special version

Order number:

Example: Internal width = 26 mm, Radius = 60 mm, Bridge version = 0, Version = 0

Order number: 0250 026 060 0000

Please order per chain 2 chain connections. You will automatically receive 1 piece with bore and 1 piece with bolt.

Prices on request
 Subject to technical modifications.

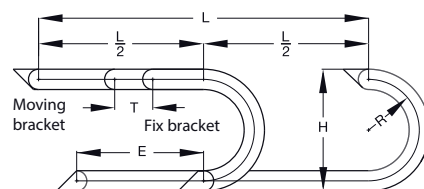

Conduit conveyance outside the middle Conduit conveyance in the middle

L = Moving distance, R = Radius,
 H = Installation height, T = Pitch,
 E = Distance between entry point and middle of movement distance

Specification of the chain length

$$\text{Length} = \frac{L}{2} + p \times R + 2 \times T + E$$

< 1 m Chain = 33 piece. Chain links à 30 mm

The fixed point of the drag chain should be in the middle of the movement distance

This arrangement gives the shortest connection between fixed point and the moving consumer and thus the most efficient chain length.

SAFELINE EFK 36G



Technical data

- Internal height 36 mm
- Internal width 62-125 mm
- Loading side - inside bend
- Links per meter: 25
- Chain pitch: 40 mm
- Maximum cable diameter: 32 mm
- Maximum movement distance: max. 80 m
- Material: Modified Polyamid

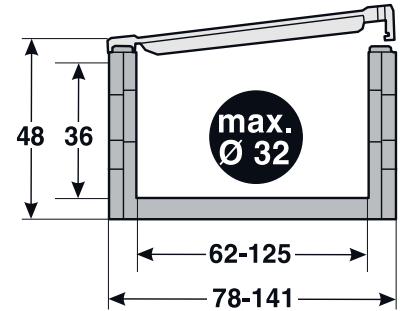

Version (order code)

Bridge version (order code)

Radius (order code) in mm

Internal width (order code) in mm

Outer width in mm

R	HS	HMA
mm	mm	mm
80	240	208
100	280	248
125	330	298
200	380	348
200	480	448

Open installation height: $HS = 2xR + HG + S$

Connection height bottom/top: $HMA = 2xR + HG$

External height pre-tension: $HG = 48$ mm

Safety: $S = 32$ mm

Pitch chain link: $T = 40$ mm

82	62	062	80	080		
106	86	086	100	100		
122	102	102	150	150		0
145	125	125	200	200		9

Bridge version: 0 full bridge m. pre-tension

version: 0 Standard (PA)
7 ESD (PA)
9 special version

Order number:

0360 [] [] 0 [] [] 0

Example: Internal width = 62 mm, Radius = 80 mm, Bridge version = 0, Version = 0

Order number: 0360 062 080 0000

Please order per chain 2 chain connections. You will automatically receive 1 piece with bore and 1 piece with bolt.

Prices on request
Subject to technical modifications.

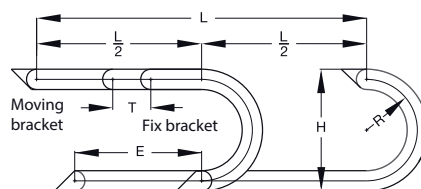

Conduit conveyance outside the middle Conduit conveyance in the middle

L = Moving distance, R = Radius,
H = Installation height, T = Pitch,
E = Distance between entry point and middle of movement distance

Specification of the chain length

$$\text{Length} = \frac{L}{2} + p \times R + 2 \times T + E$$

< 1 m Chain = 25 piece. Chain links à 40 mm

The fixed point of the drag chain should be in the middle of the movement distance

This arrangement gives the shortest connection between fixed point and the moving consumer and thus the most efficient chain length.

HEAT-SHRINK TUBE

INSULATING TUBE

BRAIDED HOSE

END CAPS

SPRO ROLLS

HTP TUBE

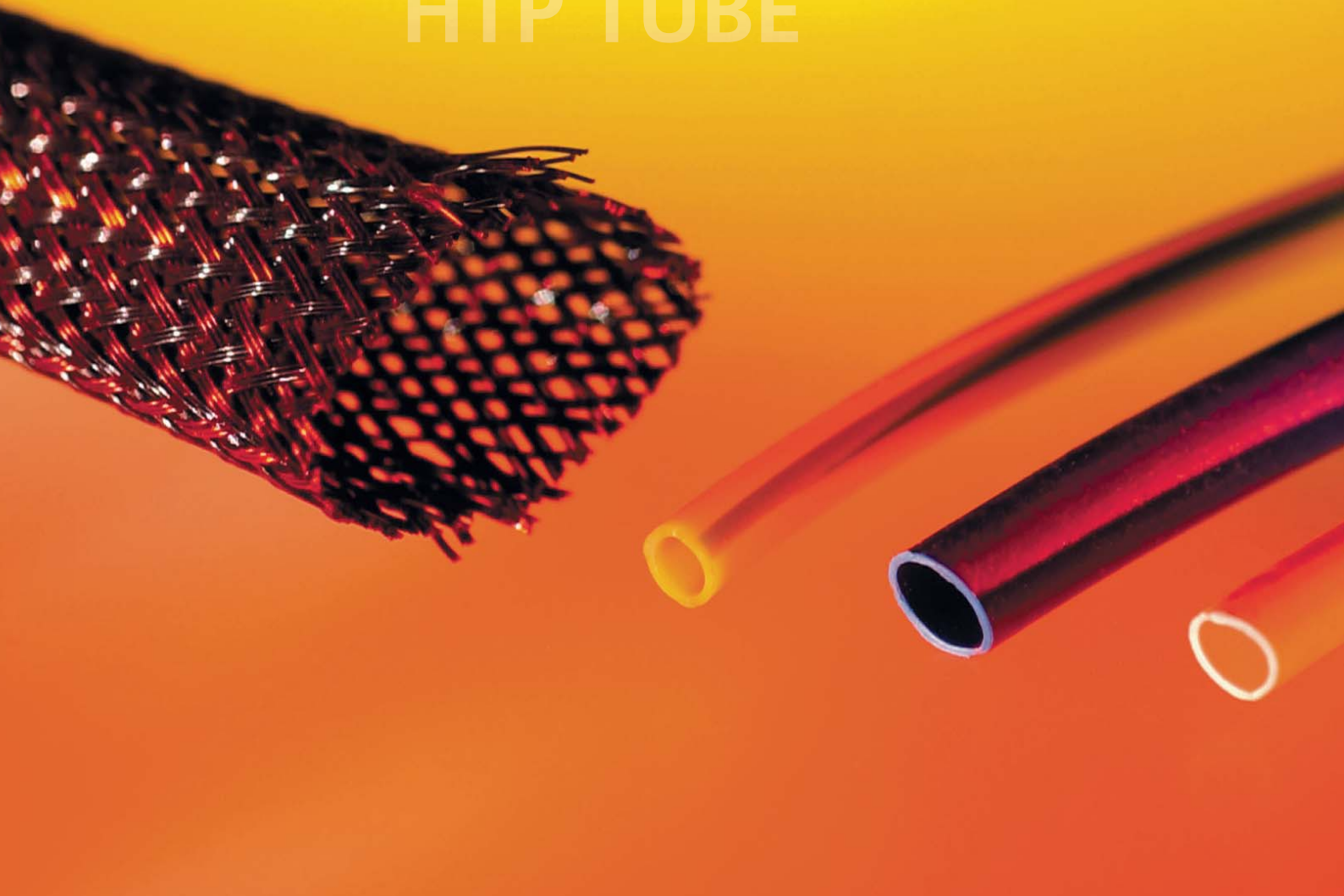

■ INSULATED, SHRINK, BRAIDED, AND TEMPERATURE PROTECTION TUBES

Series/Material	Item	Page
Braided hose		
Metal	Braided hose CU	302
	Braided hose Steel	303
Plastic	Braided hose HGP	304
High-temperature protection		
Protection tube	HTP tube	305
Accessories	HTP wrapping tape	306
	HTP adhesive tape	307
	HTP clamping rings	308
Insulation		
PVC	Insulating tube IB	309
	Insulating tube IC	310
Silicone	Insulating tube SI	311
Shrinking		
PVC	Heat-shrink tube SCH	312
Polyolefin	Heat-shrink tube HSB boxes	313
	Heat-shrink tube CMP	314
	Heat-shrink tube SPSP spools	315
	Heat-shrink tube SPRO rolls 2:1	317
	Heat-shrink tube SPRO rolls 3:1	319
Polyolefin - halogen-free	Heat-shrink tube HFS	320
Polyolefin with internal adhesive	Heat-shrink tube SK	321
	Heat-shrink tube SK M	322
	Heat-shrink tube SK-D	323
FKM	Heat-shrink tube SVRO	324
End caps		
	End caps EKI	325

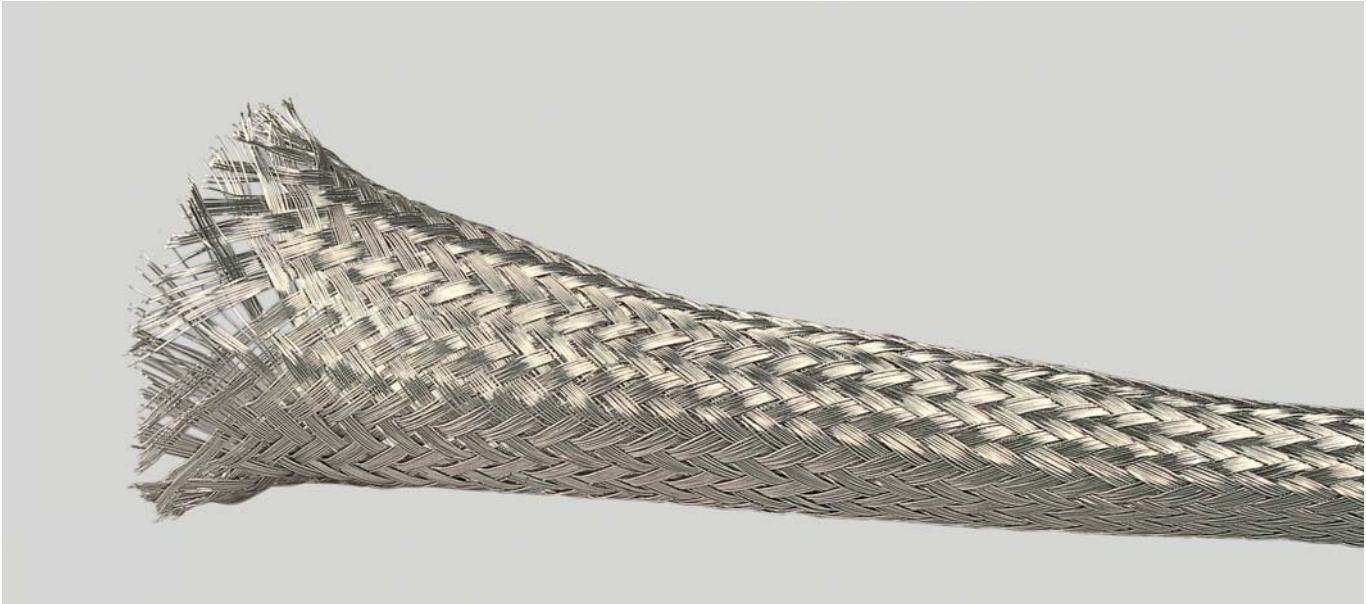

Braided hose CU

Braided sleeve for screening and interference protection of electrical cables and wires; also used for mechanical protection and building.

Application

- Plant and machine construction
- Robotics
- Automation technology
- Vehicle construction and shipbuilding
- Railway technology
- Installation technology
- Control cabinet construction

Material

Copper, tinned

Properties

Axially compressible

Note

Also available in 10m lengths

Technical data

Temperature range: -75°C up to +150°C

Copper, tinned

Part no.	Min. inner Ø mm	Max. inner Ø mm	PU per metre	Net EUR/100 metres at a purchase of		
				up to 100	101 - 500	501 - 1000
97397	5,0	12,0	100,0	o. r.	o. r.	o. r.
97399	8,0	17,0	50,0	o. r.	o. r.	o. r.
97400	12,0	22,0	50,0	o. r.	o. r.	o. r.
97402	16,0	27,0	50,0	o. r.	o. r.	o. r.
97403	20,0	35,0	25,0	o. r.	o. r.	o. r.

Dimensions and specifications may be changed without prior notice.

o. r. = on request

Steel Braided hose

Galvanized steel

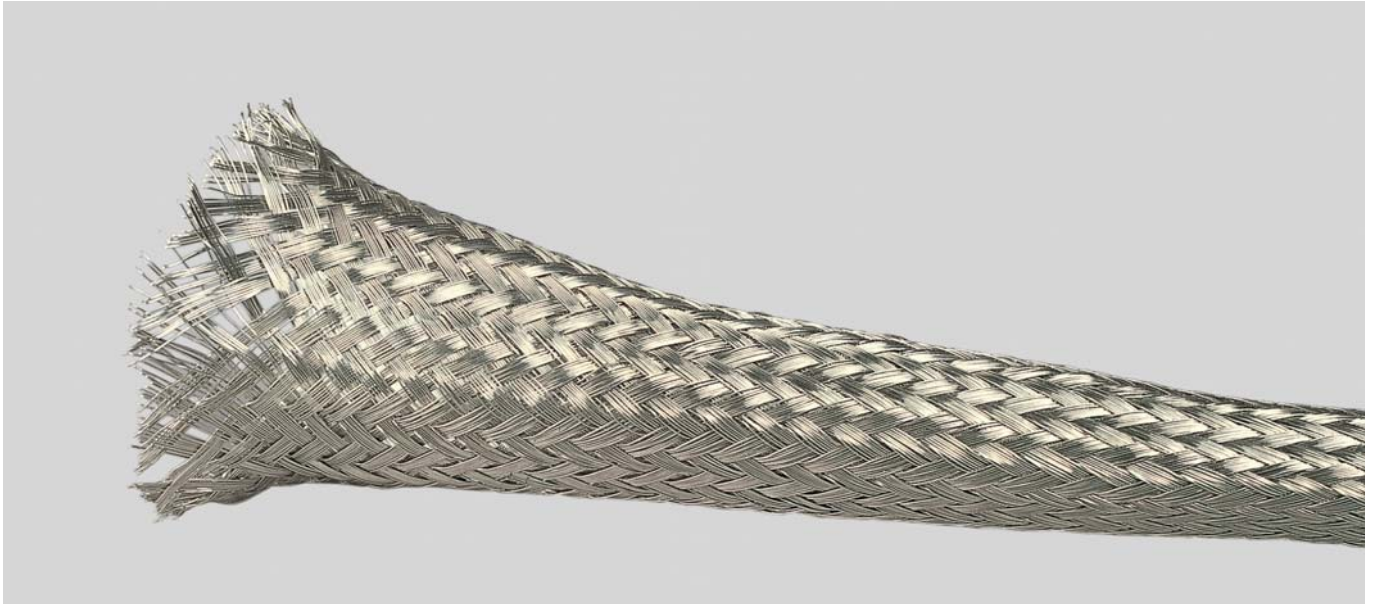

Braided hose steel

Braided sleeve for screening, bundling and mechanical protection of electrical cables and wires.

Application

- Plant and machine construction
- Robotics
- Automation technology
- Vehicle construction and shipbuilding
- Railway technology
- Installation technology
- Control cabinet construction

Material

Galvanized steel

Note

Also available in 10m lengths

Technical data

Temperature range: -75°C up to +300°C

Galvanized steel

Part no.	Min. inner Ø mm	Max. inner Ø mm	PU per metre	Net EUR/100 metres at a purchase of		
				up to 100	101 - 500	501 - 1000
97197	5,0	12,0	100,0	o. r.	o. r.	o. r.
97199	8,0	17,0	50,0	o. r.	o. r.	o. r.
97200	12,0	22,0	50,0	o. r.	o. r.	o. r.
97202	16,0	27,0	50,0	o. r.	o. r.	o. r.
96561	20,0	35,0	25,0	o. r.	o. r.	o. r.

Dimensions and specifications may be changed without prior notice.

o. r. = on request

HGP Braided hose

Polyester

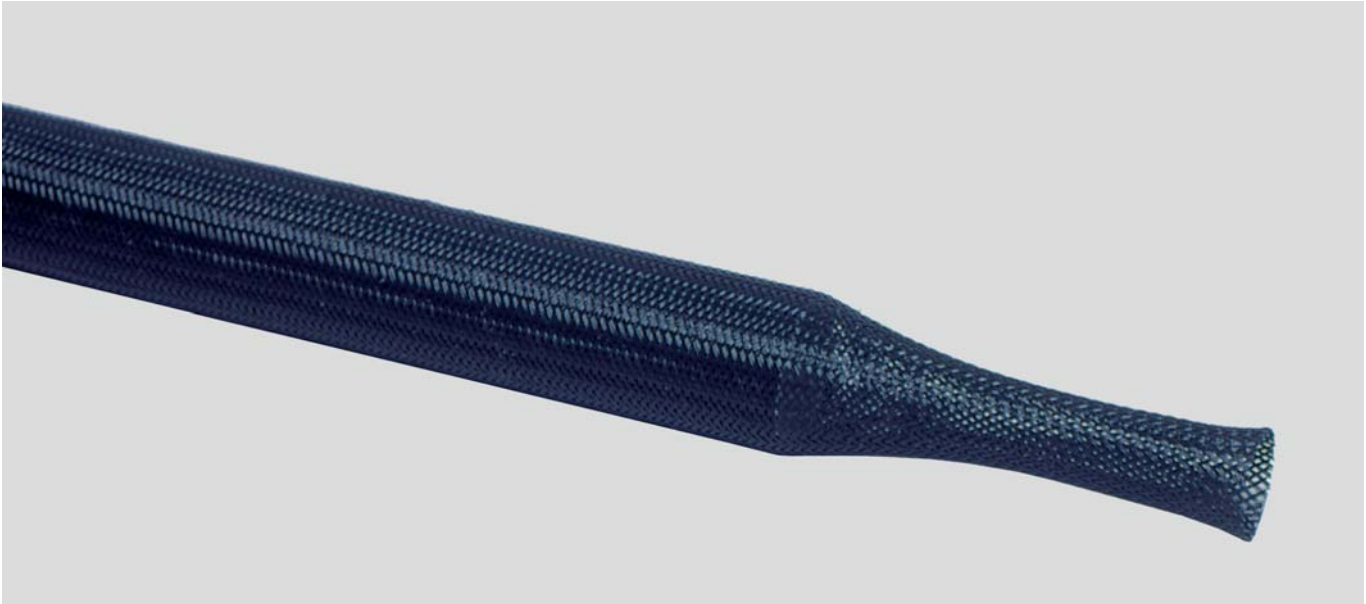

HGP

Polyester braided sleeve for bundling and for mechanical protection of electrical cables and wires.

Application

- Plant and machine construction
- Robotics
- Automation technology
- Vehicle construction and shipbuilding
- Railway technology
- Installation technology
- Control cabinet construction

Material

Polyester

- halogen-free

Properties

Axially compressible

Technical data

Temperature range: -50°C up to +150°C
Temperature range temporary up to +220°C

Polyester

Part no. grey	Part no. black	Min. inner Ø mm	Max. inner Ø mm	PU per metre	Net EUR/ 100 metres at a purchase of		
					up to 100	101 - 500	501 - 1000
94900	98136	1,0	5,0	100,0	o. r.	o. r.	o. r.
94901	98137	2,0	7,0	100,0	o. r.	o. r.	o. r.
94902	98138	3,0	9,0	100,0	o. r.	o. r.	o. r.
94903	98139	4,0	11,0	100,0	o. r.	o. r.	o. r.
94904	98140	5,0	12,0	100,0	o. r.	o. r.	o. r.
94905	98141	7,0	15,0	100,0	o. r.	o. r.	o. r.
94906	98142	8,0	17,0	50,0	o. r.	o. r.	o. r.
94907	98143	10,0	20,0	50,0	o. r.	o. r.	o. r.
94908	98144	14,0	26,0	25,0	o. r.	o. r.	o. r.
94909	98145	18,0	34,0	25,0	o. r.	o. r.	o. r.
94910	98146	20,0	40,0	25,0	o. r.	o. r.	o. r.
94911	98147	30,0	50,0	25,0	o. r.	o. r.	o. r.
94912	98148	40,0	66,0	25,0	o. r.	o. r.	o. r.

Dimensions and specifications may be changed without prior notice.

o. r. = on request

HTP Protection tube

High temperature protection

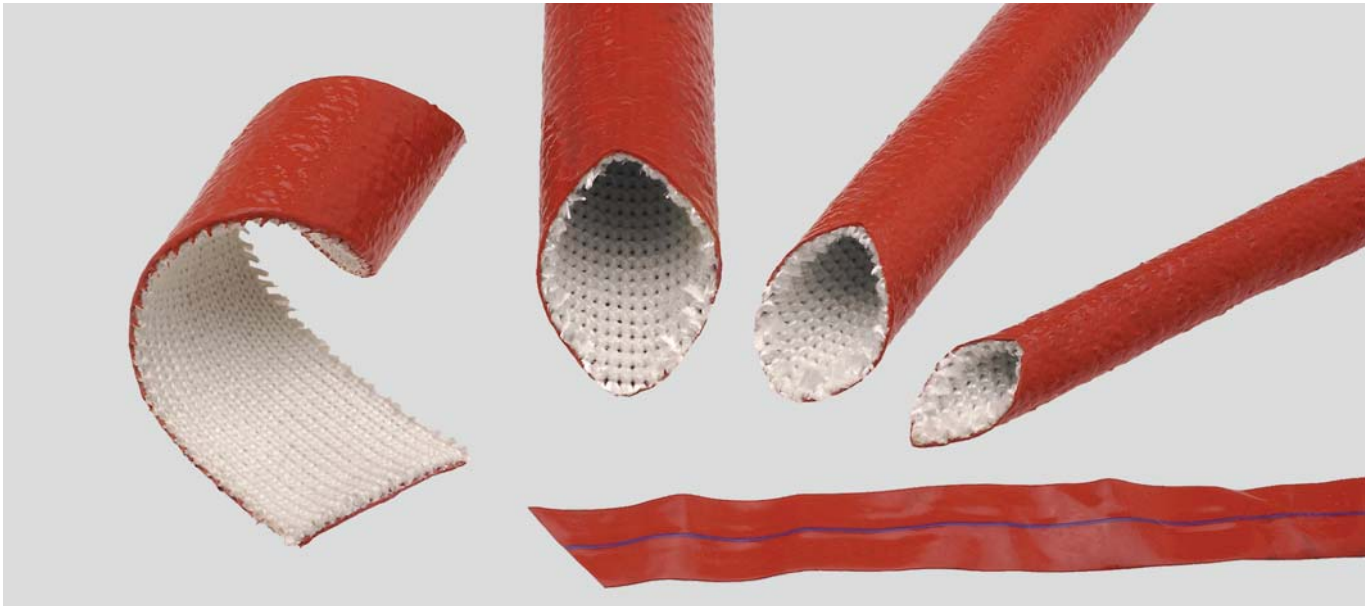

HTP

This product is extremely heat resistant. HTP has a high insulation factor and, due to the iron oxide containing silicone sheath, is resistant to small quantities of liquid steel. HTP also protects against burn injuries from steam tubes, hot air or hot water wires.

Material

Interior sheath of knitted glass-fibre braid
Silicone sheath (contains iron oxide)
Colour: orange

Technical data

Permanent load: +260°C
Short-time load: +1090°C
(up to approx. 20 minutes)
Loading moment: +1640°C
(approx. 15-30 seconds)

Protection tube

Part no. Tube version	Inner Ø mm	Width mm	PU per metre	Net EUR/100 metres at a purchase of		
				up to 100	101 - 500	501 - 1000
93630	6,0	-	15,0	o. r.	o. r.	o. r.
93632	10,0	-	15,0	o. r.	o. r.	o. r.
904924	13,0	-	15,0	o. r.	o. r.	o. r.
93634	19,0	-	15,0	o. r.	o. r.	o. r.
93635	22,0	-	15,0	o. r.	o. r.	o. r.
93636	25,0	-	15,0	o. r.	o. r.	o. r.
93637	32,0	-	15,0	o. r.	o. r.	o. r.
93638	38,0	-	15,0	o. r.	o. r.	o. r.
93639	44,0	-	15,0	o. r.	o. r.	o. r.
93640	57,0	-	15,0	o. r.	o. r.	o. r.
93641	64,0	-	15,0	o. r.	o. r.	o. r.
93642	76,0	-	15,0	o. r.	o. r.	o. r.
93643	89,0	-	15,0	o. r.	o. r.	o. r.
93644	102,0	-	15,0	o. r.	o. r.	o. r.

Dimensions and specifications may be changed without prior notice.

o. r. = on request

Matching accessory



Conduit gland LT straight

LIQUIDTIGHT gland for plastic-coated metallic protection tubes and high temperature protection tubes HTP (An additional clamping ring is required). UL/CSA approval.

The conical earthing sleeve offers maximum surface contact for optimum sealing and earthing.

refer to page 269

HTP Wrapping tape

High temperature protection



HTP

This product is extremely heat resistant. HTP has a high insulation factor and, due to the iron oxide containing silicone sheath, is resistant to small quantities of liquid steel. HTP also protects against burn injuries from steam tubes, hot air or hot water wires.

Material

Interior sheath of knitted glass-fibre braid
Silicone sheath (contains iron oxide)
Colour: orange

Technical data

Permanent load: +260°C
Short-time load: +1090°C
(up to approx. 20 minutes)
Loading moment: +1640°C
(approx. 15-30 seconds)

Wrapping tape

Part no. Cable wrap version	Inner Ø mm	Width mm	PU per metre	Net EUR/100 metres at a purchase of		
				up to 100	101 - 500	501 - 1000
94721	-	25,0	15,0	o. r.	o. r.	o. r.
94722	-	51,0	15,0	o. r.	o. r.	o. r.
94723	-	76,0	15,0	o. r.	o. r.	o. r.
94724	-	102,0	15,0	o. r.	o. r.	o. r.
94758	-	127,0	15,0	o. r.	o. r.	o. r.

Dimensions and specifications may be changed without prior notice.

o. r. = on request

HTP Adhesive tape

High temperature protection

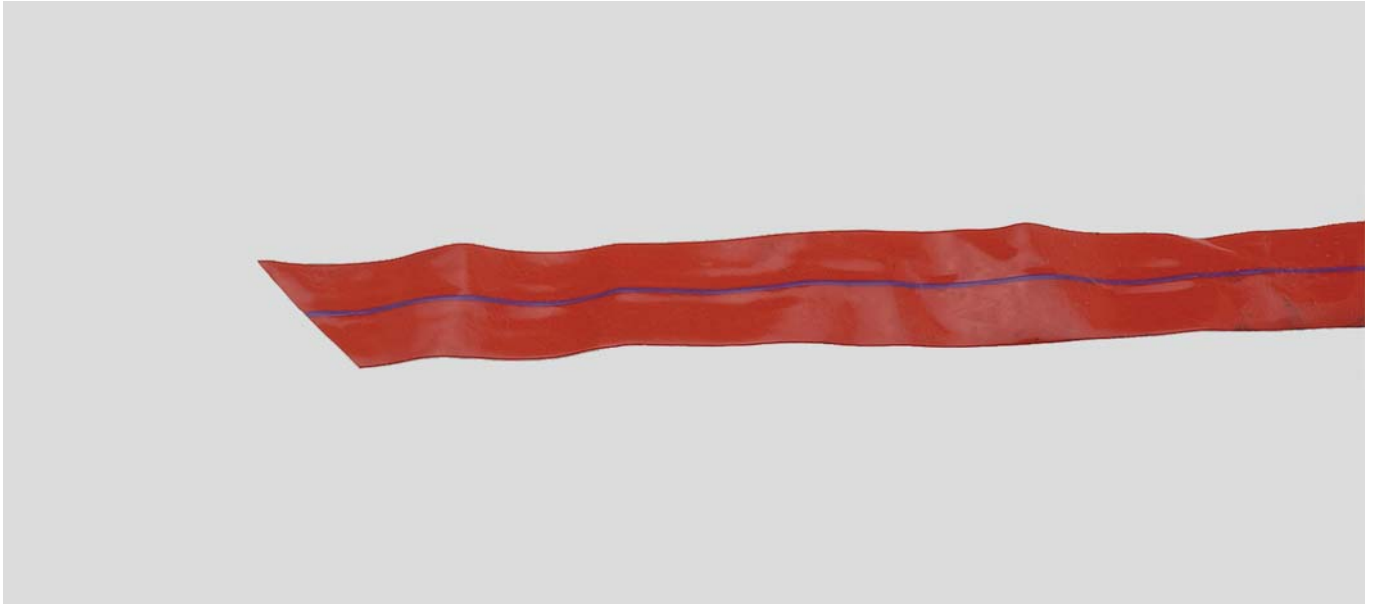

HTP

This product is extremely heat resistant. HTP has a high insulation factor and, due to the iron oxide containing silicone sheath, is resistant to small quantities of liquid steel. HTP also protects against burn injuries from steam tubes, hot air or hot water wires.

Material

Interior sheath of knitted glass-fibre braid
Silicone sheath (contains iron oxide)
Colour: orange

Technical data

Permanent load: +260°C

Adhesive tape

Part no.	Inner Ø	Width	PU per	Net EUR/100 metres at a purchase of		
Adhesive tape version	mm	mm	metre	up to 100	101 - 500	501 - 1000
93645	-	25,0	11,0	o. r.	o. r.	o. r.

Dimensions and specifications may be changed without prior notice.

o. r. = on request

HTP Clamping ring

High temperature protection

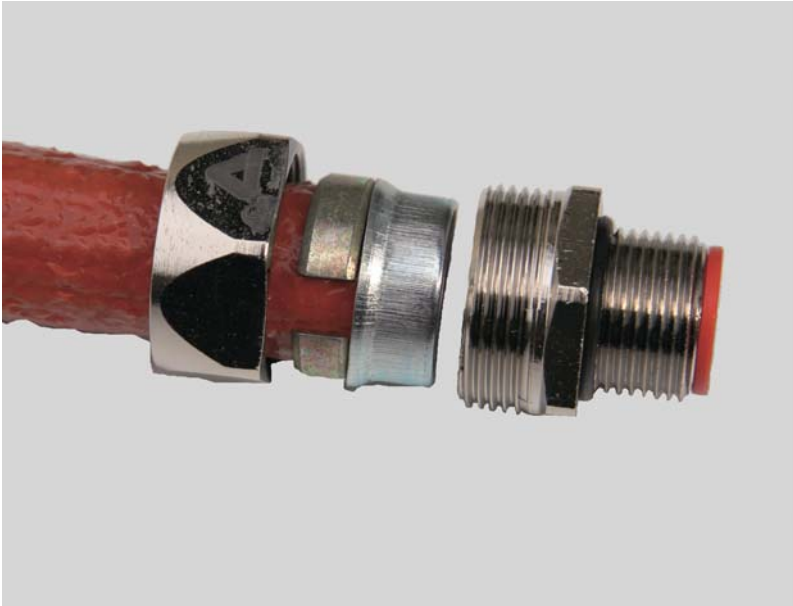

Clamping rings for braided sleeve HTP

To assemble the tube connectors LT to the high temperature protection tube HTP. The plastic clamping ring is replaced by the brass clamping ring.

Material

Brass, nickel plated

Note

In conjunction with the tube connectors LT: Protection classification IP 54

Technical data

Temperature range: -45°C up to +105°C

Clamping ring

Part no.	Size	Nominal size mm	Unit	Net EUR/100 items at a purchase of		
				up to 100	101 - 500	501 - 1000
905439	M16 x 1,5	13	50	o. r.	o. r.	o. r.
905555	M20 x 1,5	16	50	o. r.	o. r.	o. r.
905440	M25 x 1,5	22	25	o. r.	o. r.	o. r.
905557	M32 x 1,5	25	10	o. r.	o. r.	o. r.
905558	M40 x 1,5	35	5	o. r.	o. r.	o. r.
905559	M50 x 1,5	38	5	o. r.	o. r.	o. r.
905441	M63 x 1,5	51	4	o. r.	o. r.	o. r.

Dimensions and specifications may be changed without prior notice.

o. r. = on request

IB Insulating tube

PVC



IB

PVC insulated tube for later insulating and bundling cables and wires.

Application

- Plant and machine construction
- Robotics
- Automation technology
- Vehicle construction and shipbuilding
- Installation technology
- Control cabinet construction

Material

PVC

Colour: black

Flammability acc. to UL 94: V0

- silicone-free

Technical data

DIN 40621

Temperature range: -20°C up to +85°C

Temperature range temporary up to +90°C

Part no.	Inner Ø mm	Wall thickness mm	PU per metre	Net EUR/100 metres at a purchase of		
				up to 100	101 - 500	501 - 1000
91310	1,0	0,3	200,0	o. r.	o. r.	o. r.
91311	2,0	0,4	200,0	o. r.	o. r.	o. r.
905179	3,5	0,4	200,0	o. r.	o. r.	o. r.
91312	3,0	0,4	200,0	o. r.	o. r.	o. r.
905180	4,5	0,5	200,0	o. r.	o. r.	o. r.
91313	4,0	0,5	200,0	o. r.	o. r.	o. r.
91314	5,0	0,6	200,0	o. r.	o. r.	o. r.
91315	6,0	0,6	200,0	o. r.	o. r.	o. r.
91316	7,0	0,7	100,0	o. r.	o. r.	o. r.
91317	8,0	0,7	100,0	o. r.	o. r.	o. r.
91318	9,0	0,7	100,0	o. r.	o. r.	o. r.
91319	10,0	0,7	100,0	o. r.	o. r.	o. r.
91320	12,0	0,8	100,0	o. r.	o. r.	o. r.
97228	14,0	1,0	100,0	o. r.	o. r.	o. r.
96795	16,0	1,0	100,0	o. r.	o. r.	o. r.
97281	18,0	1,0	25,0	o. r.	o. r.	o. r.
97162	20,0	1,2	25,0	o. r.	o. r.	o. r.
97282	22,0	1,2	25,0	o. r.	o. r.	o. r.
97283	26,0	1,0	25,0	o. r.	o. r.	o. r.

Dimensions and specifications may be changed without prior notice.

o. r. = on request

IC insulating tube

PVC

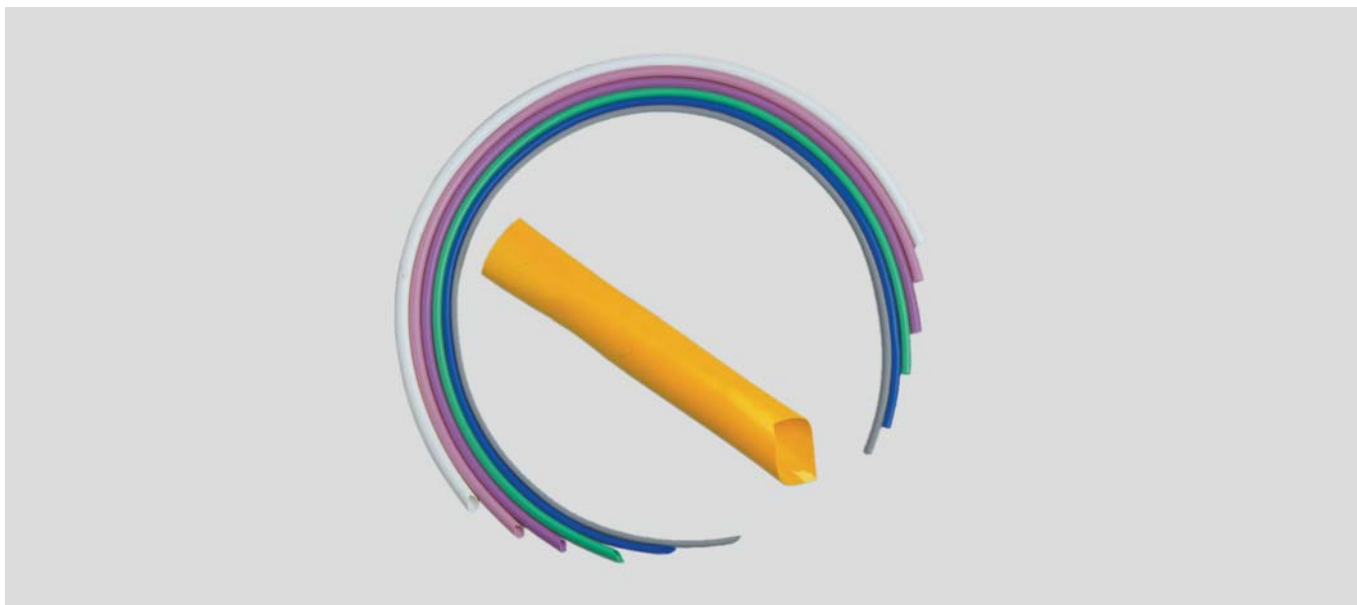

IC

PVC insulating tube for insulating and bundling cables and wires.

Application

- Plant and machine construction
- Robotics
- Automation technology
- Vehicle construction and shipbuilding
- Installation technology
- Control cabinet construction

Material

PVC

Flammability acc. to UL 94: V2

- silicone-free

Technical data

DIN 40621

Temperature range: -20°C up to +90°C

Note

Colour code:

Replace the "x" in the table with the following figures to obtain the product number of your required colour.

0=white, 1=blue, 2=yellow, 3=red,
4=transparent, 5=green, 6=orange, 7=violet,
8=grey, 9=brown

Green/yellow

Part no.	Inner Ø mm	Wall thickness mm	PU per metre	Net EUR/100 metres at a purchase of		
				up to 100	101 - 500	501 - 1000
92280	1,0	0,4	250,0	o. r.	o. r.	o. r.
92281	1,5	0,4	250,0	o. r.	o. r.	o. r.
92282	2,0	0,4	50,0	o. r.	o. r.	o. r.
92286	4,0	0,5	50,0	o. r.	o. r.	o. r.
92289	6,0	0,55	25,0	o. r.	o. r.	o. r.
92291	8,0	0,62	25,0	o. r.	o. r.	o. r.
92292	10,0	0,75	25,0	o. r.	o. r.	o. r.
92293	14,0	0,8	25,0	o. r.	o. r.	o. r.
92294	16,0	0,8	25,0	o. r.	o. r.	o. r.

Coloured

Part no.	Inner Ø mm	Wall thickness mm	PU per metre	Net EUR/100 metres at a purchase of		
				up to 100	101 - 500	501 - 1000
9210x	1,0	0,4	50,0	o. r.	o. r.	o. r.
9211x	1,5	0,4	50,0	o. r.	o. r.	o. r.
9212x	2,0	0,4	50,0	o. r.	o. r.	o. r.
9213x	2,5	0,4	50,0	o. r.	o. r.	o. r.
9214x	3,0	0,4	50,0	o. r.	o. r.	o. r.
9215x	3,5	0,4	50,0	o. r.	o. r.	o. r.
9216x	4,0	0,5	50,0	o. r.	o. r.	o. r.
9217x	4,5	0,5	25,0	o. r.	o. r.	o. r.
9218x	5,0	0,52	25,0	o. r.	o. r.	o. r.
9219x	6,0	0,55	25,0	o. r.	o. r.	o. r.
9220x	7,0	0,6	25,0	o. r.	o. r.	o. r.
9221x	8,0	0,62	25,0	o. r.	o. r.	o. r.
9222x	10,0	0,7	25,0	o. r.	o. r.	o. r.
9223x	14,0	0,8	25,0	o. r.	o. r.	o. r.
9224x	16,0	0,8	25,0	o. r.	o. r.	o. r.
9225x	20,0	0,8	25,0	o. r.	o. r.	o. r.
9226x	26,0	1,0	25,0	o. r.	o. r.	o. r.
9227x	36,0	1,0	25,0	o. r.	o. r.	o. r.

Dimensions and specifications may be changed without prior notice.

o. r. = on request

SI Insulating tube

Silicone



SI

Silicone insulating tube for insulating and bundling wires and lines.

Application

- Plant and machine construction
- Robotics
- Automation technology
- Vehicle construction and shipbuilding
- Installation technology
- Control cabinet construction

Properties

Softener and heavy metal free, physiologically and toxicologically harmless with good chemical resistance.

Technical data

DIN 40628

Temperature range: -50°C up to +180°C

Part no.	Inner Ø mm	Wall thickness mm	PU per metre	Net EUR/100 metres at a purchase of		
				up to 100	101 - 500	501 - 1000
94741	1,0	0,4	100,0	o. r.	o. r.	o. r.
94742	2,0	0,4	100,0	o. r.	o. r.	o. r.
97203	3,0	0,4	100,0	o. r.	o. r.	o. r.
97426	4,0	0,5	100,0	o. r.	o. r.	o. r.
97427	5,0	0,6	100,0	o. r.	o. r.	o. r.
97757	6,0	0,6	100,0	o. r.	o. r.	o. r.
94743	8,0	0,7	100,0	o. r.	o. r.	o. r.
94744	10,0	0,7	50,0	o. r.	o. r.	o. r.
94745	12,0	0,8	50,0	o. r.	o. r.	o. r.
94746	14,0	0,8	50,0	o. r.	o. r.	o. r.
94747	16,0	0,8	50,0	o. r.	o. r.	o. r.

Dimensions and specifications may be changed without prior notice.

o. r. = on request

SCH Heat-shrink tubing 2:1

PVC

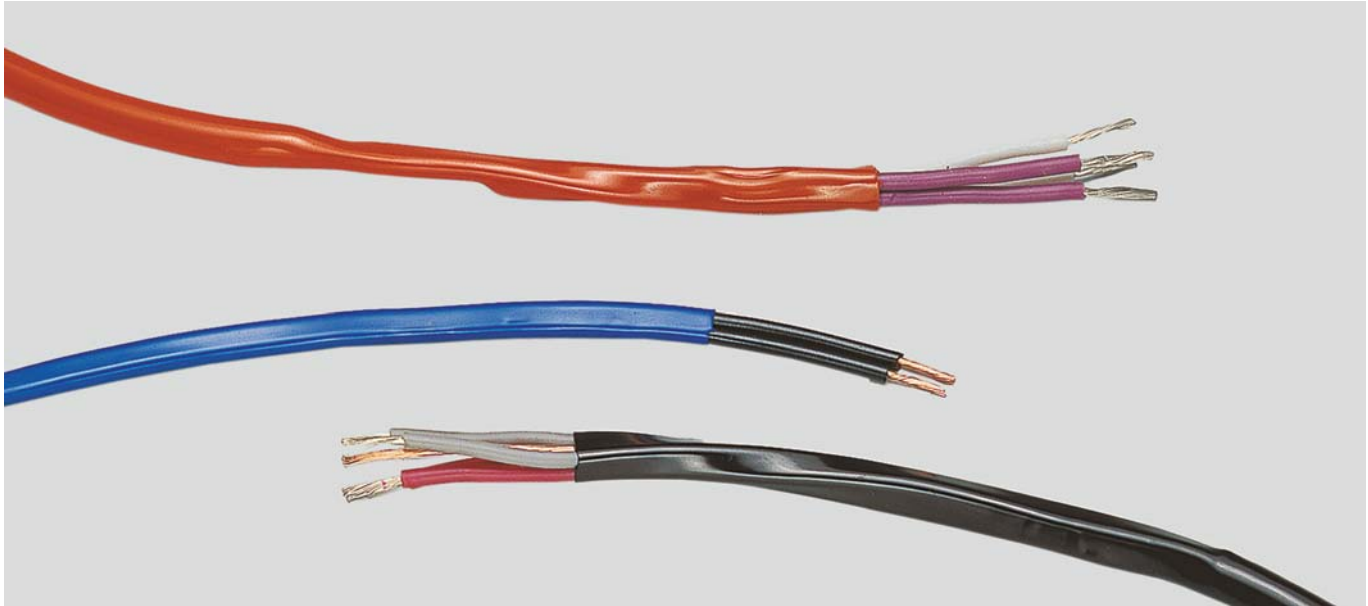

SCH

PVC shrink tubing for repairing insulation and sealing electrical components.

Application

- Plant and machine construction
- Robotics
- Automation technology
- Vehicle construction and shipbuilding
- Installation technology
- Control cabinet construction

Material

PVC

Colour: black

Flammability acc. to UL 94: V0

- silicone-free

Technical data

Temperature range: -20°C up to +90°C

Note

Attention: Do not store tubes at temperatures over 18°C! Otherwise properties will be changed! Longitude shrinkage approx. 20-30%
The colours orange, yellow, white, blue, green, brown, red are available on request.

Black

Part no.	Inner Ø before shrinkage mm	Wall thickness mm	Inner Ø after shrinkage mm	Content m	Net EUR/100 metres at a purchase of		
					up to 100	101 - 500	501 - 1000
91300	2,5	0,2	1,2	100,0	o. r.	o. r.	o. r.
91301	4,0	0,25	2,0	100,0	o. r.	o. r.	o. r.
91302	6,0	0,25	3,0	100,0	o. r.	o. r.	o. r.
91303	7,0	0,25	4,0	100,0	o. r.	o. r.	o. r.
91304	11,0	0,3	6,0	100,0	o. r.	o. r.	o. r.
91305	14,0	0,3	8,0	100,0	o. r.	o. r.	o. r.
91306	17,0	0,4	10,0	100,0	o. r.	o. r.	o. r.
91307	20,0	0,5	13,0	100,0	o. r.	o. r.	o. r.
91308	25,0	0,5	16,0	50,0	o. r.	o. r.	o. r.
91309	31,0	0,5	20,0	50,0	o. r.	o. r.	o. r.

Dimensions and specifications may be changed without prior notice.

o. r. = on request

HSB - Boxes Heat shrink 2:1

Polyolefin



HSB boxes

Polyolefin shrink tube for repairing insulation and sealing electrical components.

Material

PO (Polyolefin)

Technical data

Temperature range: -55°C up to +125°C

Note

Form of shipment: HSB box
Other colours on request.

Black

Part no.	Type T & B	Inner Ø before shrinkage mm	Wall thickness mm	Inner Ø after shrinkage mm	Content m	Unit	Net EUR/item at a purchase of		
							up to 5	6 - 10	11 - 20
91321	HSB 46	1,2	0,4	0,6	12,0	1	o. r.	o. r.	o. r.
91322	HSB 63	1,6	0,4	0,8	12,0	1	o. r.	o. r.	o. r.
91323	HSB 93	2,4	0,5	1,2	11,5	1	o. r.	o. r.	o. r.
91324	HSB 125	3,2	0,5	1,6	11,5	1	o. r.	o. r.	o. r.
91325	HSB 187	4,7	0,5	2,4	9,5	1	o. r.	o. r.	o. r.
91326	HSB 250	6,4	0,6	3,2	7,5	1	o. r.	o. r.	o. r.
91327	HSB 375	9,5	0,6	4,7	6,5	1	o. r.	o. r.	o. r.
91328	HSB 500	12,7	0,7	6,4	6,0	1	o. r.	o. r.	o. r.
91329	HSB 750	19,1	0,7	9,5	5,0	1	o. r.	o. r.	o. r.
91330	HSB 1000	25,4	0,8	12,7	3,3	1	o. r.	o. r.	o. r.

Transparent

Part no.	Type T & B	Inner Ø before shrinkage mm	Wall thickness mm	Inner Ø after shrinkage mm	Content m	Unit	Net EUR/item at a purchase of		
							up to 5	6 - 10	11 - 20
98519	HSB 46-C	1,2	0,4	0,6	12,0	1	o. r.	o. r.	o. r.
97085	HSB 63-C	1,6	0,4	0,8	12,0	1	o. r.	o. r.	o. r.
96277	HSB 93-C	2,4	0,5	1,2	11,5	1	o. r.	o. r.	o. r.
97485	HSB 125-C	3,2	0,5	1,6	11,5	1	o. r.	o. r.	o. r.
96687	HSB 187-C	4,7	0,5	2,4	9,5	1	o. r.	o. r.	o. r.
96830	HSB 250-C	6,4	0,6	3,2	7,5	1	o. r.	o. r.	o. r.
96761	HSB 375-C	9,5	0,6	4,7	6,5	1	o. r.	o. r.	o. r.
96752	HSB 500-C	12,7	0,7	6,4	6,0	1	o. r.	o. r.	o. r.
96751	HSB 750-C	19,1	0,7	9,5	5,0	1	o. r.	o. r.	o. r.
97107	HSB 1000-C	25,4	0,8	12,7	3,3	1	o. r.	o. r.	o. r.

Dimensions and specifications may be changed without prior notice.

o. r. = on request



CMP

Polyolefin shrink tube for repairing insulation and sealing electrical components.

Application

- Plant and machine construction
- Robotics
- Automation technology
- Vehicle construction and shipbuilding
- Railway technology
- Installation technology
- Control cabinet construction

Material

PO (Polyolefin)

Colour: black

Note

Form of shipment:
 CMP box (1.2m sections) (25 sections = 30.5m;
 10 sections = 12.2m)
 CMP rolls

Technical data

Temperature range: -55°C up to +125°C

Box

Part no.	Type T & B	Inner Ø before shrinkage mm	Wall thickness mm	Inner Ø after shrinkage mm	Content m	Unit	Net EUR/unit at a purchase of		
							up to 5	6 - 10	11 - 20
91290	CMP 46-0-A	1,2	0,2	0,6	30,5	1	o. r.	o. r.	o. r.
91291	CMP 63-0-A	1,6	0,2	0,8	30,5	1	o. r.	o. r.	o. r.
91292	CMP 93-0-A	2,4	0,25	1,2	30,5	1	o. r.	o. r.	o. r.
91293	CMP 125-0-A	3,2	0,25	1,6	30,5	1	o. r.	o. r.	o. r.
91294	CMP 187-0-A	4,7	0,25	2,4	30,5	1	o. r.	o. r.	o. r.
91295	CMP 250-0-A	6,4	0,3	3,2	30,5	1	o. r.	o. r.	o. r.
91296	CMP 375-0-A	9,5	0,3	4,8	30,5	1	o. r.	o. r.	o. r.
91297	CMP 500-0-A	12,7	0,3	6,4	30,5	1	o. r.	o. r.	o. r.
91298	CMP 750-0-A	19,1	0,4	9,5	12,2	1	o. r.	o. r.	o. r.
91299	CMP 1000-0-A	25,4	0,45	12,7	12,2	1	o. r.	o. r.	o. r.

Coil

Part no.	Type T & B	Inner Ø before shrinkage mm	Wall thickness mm	Inner Ø after shrinkage mm	Content m	Unit	Net EUR/100 metres at a purchase of		
							up to 100	101 - 500	501 - 1000
91331	CMP 46-0-BG	1,2	0,2	0,6	300,0	-	o. r.	o. r.	o. r.
91332	CMP 63-0-BG	1,6	0,2	0,8	300,0	-	o. r.	o. r.	o. r.
91333	CMP 93-0-BG	2,4	0,25	1,2	300,0	-	o. r.	o. r.	o. r.
91334	CMP 125-0-BG	3,2	0,25	1,6	300,0	-	o. r.	o. r.	o. r.
91335	CMP 187-0-BG	4,7	0,25	2,4	300,0	-	o. r.	o. r.	o. r.
91336	CMP 250-0-BG	6,4	0,3	3,2	300,0	-	o. r.	o. r.	o. r.
91337	CMP 375-0-BG	9,5	0,3	4,8	150,0	-	o. r.	o. r.	o. r.
91338	CMP 500-0-BG	12,7	0,3	6,4	100,0	-	o. r.	o. r.	o. r.
91339	CMP 750-0-BG	19,1	0,4	9,5	50,0	-	o. r.	o. r.	o. r.
91340	CMP 1000-0-BG	25,4	0,45	12,7	50,0	-	o. r.	o. r.	o. r.

Dimensions and specifications may be changed without prior notice.

o. r. = on request

SPSP - spools Heat shrink 2:1



Polyolefin

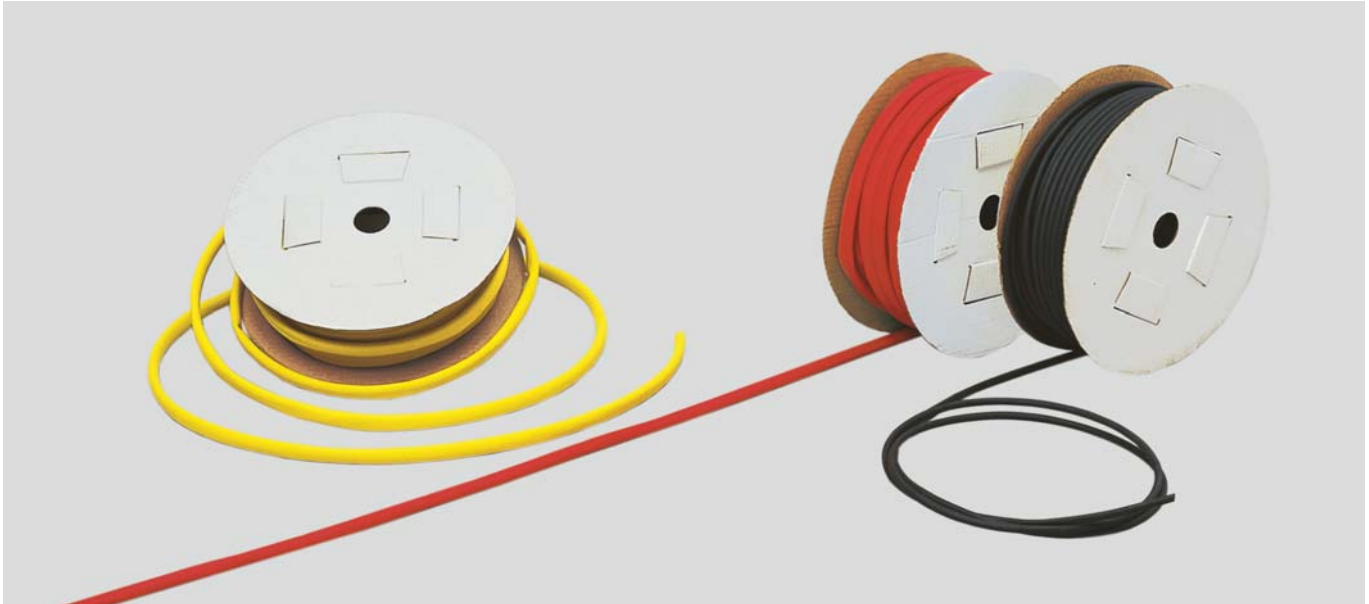

SPSP spools

Polyolefin shrink tube for repairing insulation and sealing electrical components.

Application

- Plant and machine construction
- Robotics
- Automation technology
- Vehicle construction and shipbuilding
- Railway technology
- Installation technology
- Control cabinet construction

Material

PO (Polyolefin)

Note

Replace the "x" in the table with the following numbers to obtain the product number of your required colour.

Colour code:

- 0=white
- 1=blue
- 2=yellow
- 3=red
- 4=transparent
- 6=brown
- 7=orange
- 8=grey
- 9=green

Technical data

Temperature range: -55°C up to +135°C

Black

Part no.	Inner Ø before shrinkage mm	Wall thickness mm	Inner Ø after shrinkage mm	Content m	Unit	Net EUR/100 metres at a purchase of		
						up to 5	6 - 10	11 - 20
91777	1,2	0,4	0,6	20,0	1	o. r.	o. r.	o. r.
91778	1,6	0,4	0,8	20,0	1	o. r.	o. r.	o. r.
91779	2,4	0,5	1,2	20,0	1	o. r.	o. r.	o. r.
91780	3,2	0,5	1,6	20,0	1	o. r.	o. r.	o. r.
91781	4,8	0,5	2,4	20,0	1	o. r.	o. r.	o. r.
91782	6,4	0,6	3,2	10,0	1	o. r.	o. r.	o. r.
91783	9,5	0,6	4,7	10,0	1	o. r.	o. r.	o. r.
91784	12,7	0,6	6,4	10,0	1	o. r.	o. r.	o. r.
91785	19,1	0,8	9,5	10,0	1	o. r.	o. r.	o. r.
91786	25,4	0,9	12,7	10,0	1	o. r.	o. r.	o. r.

Green/yellow

Part no.	Inner Ø before shrinkage mm	Wall thickness mm	Inner Ø after shrinkage mm	Content m	Unit	Net EUR/100 metres at a purchase of		
						up to 5	6 - 10	11 - 20
92335	2,4	0,5	1,2	20,0	1	o. r.	o. r.	o. r.
92345	3,2	0,5	1,6	20,0	1	o. r.	o. r.	o. r.
92355	4,8	0,5	2,4	20,0	1	o. r.	o. r.	o. r.
92365	6,4	0,6	3,2	10,0	1	o. r.	o. r.	o. r.
92375	9,5	0,6	4,7	10,0	1	o. r.	o. r.	o. r.
92385	12,7	0,6	6,4	10,0	1	o. r.	o. r.	o. r.
92395	19,1	0,8	9,5	10,0	1	o. r.	o. r.	o. r.
92405	25,4	0,9	12,7	10,0	1	o. r.	o. r.	o. r.

Continuation ►

SPSP - spools Heat shrink 2:1



Polyolefin

Coloured

Part no.	Inner Ø before shrinkage mm	Wall thickness mm	Inner Ø after shrinkage mm	Content m	Unit	Net EUR/100 metres at a purchase of		
						up to 5	6 - 10	11 - 20
9231x	1,2	0,4	0,6	20,0	1	o. r.	o. r.	o. r.
9232x	1,6	0,4	0,8	20,0	1	o. r.	o. r.	o. r.
9233x	2,4	0,5	1,2	20,0	1	o. r.	o. r.	o. r.
9234x	3,2	0,5	1,6	20,0	1	o. r.	o. r.	o. r.
9235x	4,8	0,5	2,4	20,0	1	o. r.	o. r.	o. r.
9236x	6,4	0,6	3,2	10,0	1	o. r.	o. r.	o. r.
9237x	9,5	0,6	4,7	10,0	1	o. r.	o. r.	o. r.
9238x	12,7	0,6	6,4	10,0	1	o. r.	o. r.	o. r.
9239x	19,1	0,8	9,5	10,0	1	o. r.	o. r.	o. r.
9240x	25,4	0,9	12,7	10,0	1	o. r.	o. r.	o. r.

Dimensions and specifications may be changed without prior notice.

o. r. = on request

SPRO - rolls Heat shrink 2:1



Polyolefin

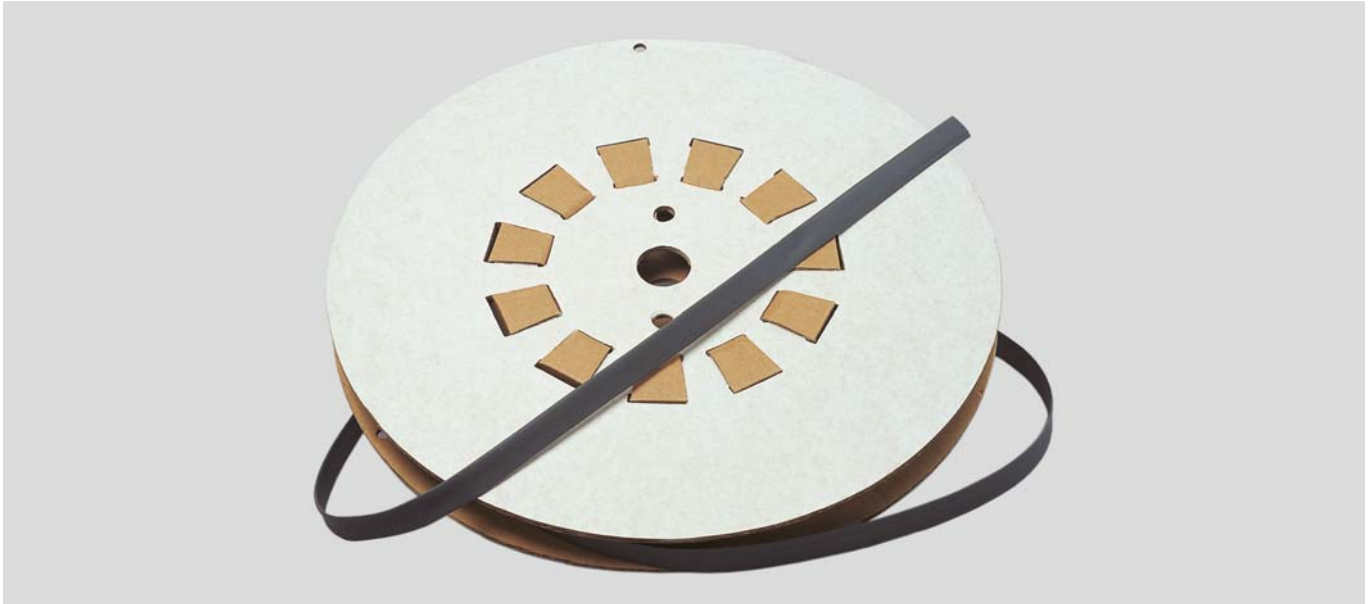

SPRO rolls 2:1

Polyolefin shrink tube for repairing insulation and sealing electrical components.

Application

- Plant and machine construction
- Robotics
- Automation technology
- Vehicle construction and shipbuilding
- Railway technology
- Installation technology
- Control cabinet construction

Material

PO (Polyolefin)

Note

Replace the "x" in the table with the numbers figures to obtain the product number of your required colour.

Colour code:

- 0=white
- 1=blue
- 2=yellow
- 3=red
- 4=transparent
- 6=brown
- 7=orange
- 8=grey
- 9=green

Technical data

Temperature range: -55°C up to +135°C

Black

Part no. Roll	Inner Ø before shrinkage mm	Wall thickness mm	Inner Ø after shrinkage mm	Content m	Unit	Net EUR/ 100 metres at a purchase of		
						up to 100	101 - 500	501 - 1000
91788	1,2	0,4	0,6	150,0	-	o. r.	o. r.	o. r.
91789	1,6	0,4	0,8	150,0	-	o. r.	o. r.	o. r.
91790	2,4	0,5	1,2	150,0	-	o. r.	o. r.	o. r.
91791	3,2	0,5	1,6	150,0	-	o. r.	o. r.	o. r.
91792	4,8	0,5	2,4	75,0	-	o. r.	o. r.	o. r.
91793	6,4	0,6	3,2	75,0	-	o. r.	o. r.	o. r.
91794	9,5	0,6	4,7	75,0	-	o. r.	o. r.	o. r.
91795	12,7	0,6	6,4	50,0	-	o. r.	o. r.	o. r.
90058	16,0	0,6	8,0	50,0	-	o. r.	o. r.	o. r.
91796	19,1	0,8	9,5	30,0	-	o. r.	o. r.	o. r.
91797	25,4	0,9	12,7	30,0	-	o. r.	o. r.	o. r.
904771	32,0	0,9	16,0	30,0	-	o. r.	o. r.	o. r.
91798	38,1	1,0	19,0	30,0	-	o. r.	o. r.	o. r.
91799	50,8	1,1	25,4	30,0	-	o. r.	o. r.	o. r.
96828	76,2	1,3	38,1	15,0	-	o. r.	o. r.	o. r.
96929	101,0	1,4	50,8	15,0	-	o. r.	o. r.	o. r.

Continuation ►

SPRO - rolls Heat shrink 2:1



Polyolefin

Green/yellow

Part no. Roll	Inner Ø before shrinkage mm	Wall thickness mm	Inner Ø after shrinkage mm	Content m	Unit	Net EUR/ 100 metres at a purchase of		
						up to 100	101 - 500	501 - 1000
92435	2,4	0,5	1,2	150,0	-	o. r.	o. r.	o. r.
92445	3,2	0,5	1,6	150,0	-	o. r.	o. r.	o. r.
92455	4,8	0,5	2,4	75,0	-	o. r.	o. r.	o. r.
92465	6,4	0,6	3,2	75,0	-	o. r.	o. r.	o. r.
92475	9,5	0,6	4,7	75,0	-	o. r.	o. r.	o. r.
92485	12,7	0,6	6,4	100,0	-	o. r.	o. r.	o. r.
92495	19,1	0,8	9,5	30,0	-	o. r.	o. r.	o. r.
92505	25,4	0,9	12,7	30,0	-	o. r.	o. r.	o. r.
92515	38,1	1,0	19,0	30,0	-	o. r.	o. r.	o. r.
92425	50,8	1,0	25,4	30,0	-	o. r.	o. r.	o. r.

Coloured

Part no. Roll	Inner Ø before shrinkage mm	Wall thickness mm	Inner Ø after shrinkage mm	Content m	Unit	Net EUR/ 100 metres at a purchase of		
						up to 100	101 - 500	501 - 1000
9241x	1,2	0,4	0,6	150,0	-	o. r.	o. r.	o. r.
9242x	1,6	0,4	0,8	150,0	-	o. r.	o. r.	o. r.
9243x	2,4	0,5	1,2	150,0	-	o. r.	o. r.	o. r.
9244x	3,2	0,5	1,6	150,0	-	o. r.	o. r.	o. r.
9245x	4,8	0,5	2,4	75,0	-	o. r.	o. r.	o. r.
9246x	6,4	0,6	3,2	75,0	-	o. r.	o. r.	o. r.
9247x	9,5	0,6	4,7	75,0	-	o. r.	o. r.	o. r.
9248x	12,7	0,6	6,4	100,0	-	o. r.	o. r.	o. r.
9249x	19,1	0,8	9,5	30,0	-	o. r.	o. r.	o. r.
9250x	25,4	0,9	12,7	30,0	-	o. r.	o. r.	o. r.
9251x	38,1	1,0	19,0	30,0	-	o. r.	o. r.	o. r.

Dimensions and specifications may be changed without prior notice.

o. r. = on request

SPRO - rolls Heat shrink 3:1



Polyolefin

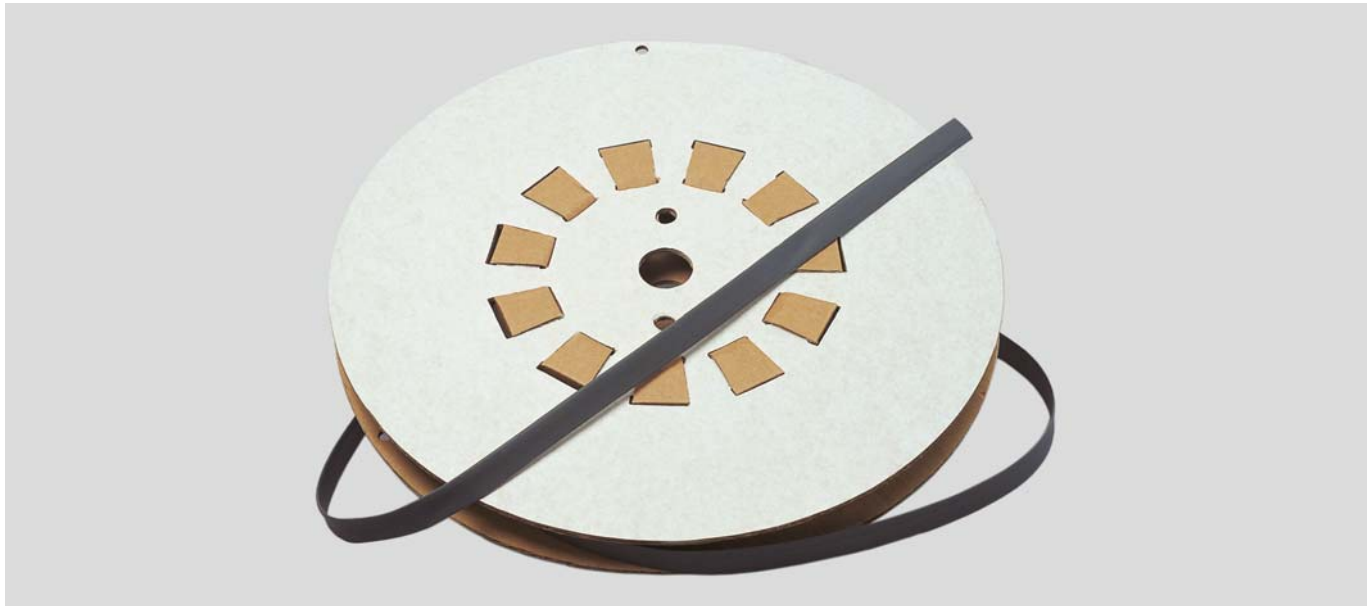

SPRO rolls 3:1

Polyolefin shrink tube for repairing insulation and sealing electrical components. Shrink rate 3:1

Application

- Plant and machine construction
- Robotics
- Automation technology
- Vehicle construction and shipbuilding
- Railway technology
- Installation technology
- Control cabinet construction

Material

PO (Polyolefin)

Note

Replace the "x" in the table with the following numbers to obtain the product number of your required colour.

Colour code:

- 1=blue
- 2=yellow
- 3=red
- 9=green

Technical data

Temperature range: -55°C up to +135°C

Black

Part no. Roll	Inner Ø before shrinkage mm	Wall thickness mm	Inner Ø after shrinkage mm	Content m	Unit	Net EUR/ 100 metres at a purchase of		
						up to 100	101 - 500	501 - 1000
903035	6,4	0,65	2,0	75,0	-	o. r.	o. r.	o. r.
903045	9,5	0,75	3,0	75,0	-	o. r.	o. r.	o. r.
903055	12,7	0,75	4,0	50,0	-	o. r.	o. r.	o. r.
903065	19,0	0,85	6,0	30,0	-	o. r.	o. r.	o. r.
903075	25,4	1,0	8,0	30,0	-	o. r.	o. r.	o. r.
903085	39,0	1,15	13,0	30,0	-	o. r.	o. r.	o. r.

Green/yellow

Part no. Roll	Inner Ø before shrinkage mm	Wall thickness mm	Inner Ø after shrinkage mm	Content m	Unit	Net EUR/ 100 metres at a purchase of		
						up to 100	101 - 500	501 - 1000
903093	6,4	0,65	2,0	75,0	-	o. r.	o. r.	o. r.
903094	9,5	0,75	3,0	75,0	-	o. r.	o. r.	o. r.
903095	12,7	0,75	4,0	50,0	-	o. r.	o. r.	o. r.
903096	19,0	0,85	6,0	30,0	-	o. r.	o. r.	o. r.
903097	25,4	1,0	8,0	30,0	-	o. r.	o. r.	o. r.
903098	39,0	1,15	13,0	30,0	-	o. r.	o. r.	o. r.

Coloured

Part no. Roll	Inner Ø before shrinkage mm	Wall thickness mm	Inner Ø after shrinkage mm	Content m	Unit	Net EUR/ 100 metres at a purchase of		
						up to 100	101 - 500	501 - 1000
90303x	6,4	0,65	2,0	75,0	-	o. r.	o. r.	o. r.
90304x	9,5	0,75	3,0	75,0	-	o. r.	o. r.	o. r.
90305x	12,7	0,75	4,0	50,0	-	o. r.	o. r.	o. r.
90306x	19,0	0,85	6,0	30,0	-	o. r.	o. r.	o. r.
90307x	25,4	1,0	8,0	30,0	-	o. r.	o. r.	o. r.
90308x	39,0	1,15	13,0	30,0	-	o. r.	o. r.	o. r.

Dimensions and specifications may be changed without prior notice.

o. r. = on request

HFS Heat-shrink 2:1 - halogen free

Polyolefin

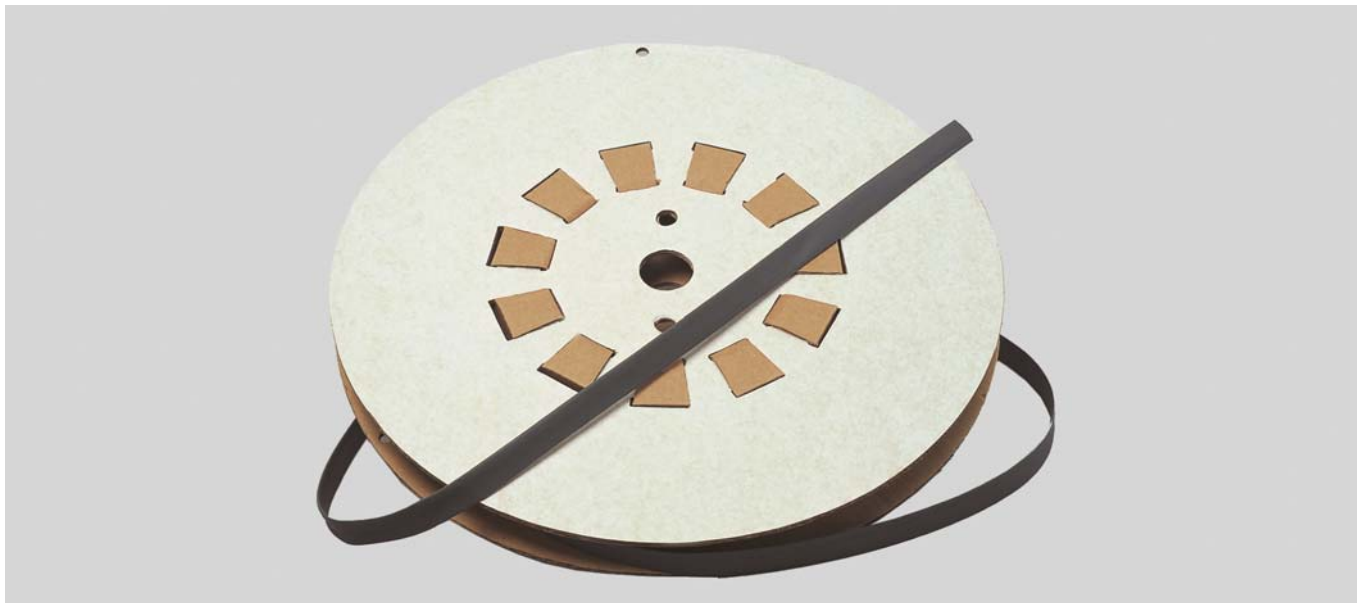

HFS rolls

Halogen-free polyolefin shrink tube for repairing insulation and sealing electrical components.

Application

- Plant and machine construction
- Automation technology
- Installation technology
- Control cabinet construction

Material

PO (Polyolefin)

Colour: black

- halogen-free

Technical data

Temperature range: -55°C up to +105°C

Black

Part no.	Inner Ø before shrinkage mm	Wall thickness mm	Inner Ø after shrinkage mm	Content m	Unit	Net EUR/ 100 items at a purchase of		
						up to 100	101 - 500	501 - 1000
99551	1,6	0,45	0,8	150,0	-	o. r.	o. r.	o. r.
99552	2,4	0,51	1,2	150,0	-	o. r.	o. r.	o. r.
99553	3,2	0,51	1,6	150,0	-	o. r.	o. r.	o. r.
99554	4,8	0,51	2,4	75,0	-	o. r.	o. r.	o. r.
99555	6,4	0,64	3,2	75,0	-	o. r.	o. r.	o. r.
99556	9,5	0,64	4,8	75,0	-	o. r.	o. r.	o. r.
99557	12,7	0,64	6,4	50,0	-	o. r.	o. r.	o. r.
99558	16,0	0,64	8,0	50,0	-	o. r.	o. r.	o. r.
99559	19,0	0,76	9,5	30,0	-	o. r.	o. r.	o. r.
99560	25,4	0,89	12,7	30,0	-	o. r.	o. r.	o. r.
99561	32,0	0,89	16,0	30,0	-	o. r.	o. r.	o. r.
99562	38,1	1,02	19,0	30,0	-	o. r.	o. r.	o. r.
99563	50,8	1,14	25,4	30,0	-	o. r.	o. r.	o. r.

Dimensions and specifications may be changed without prior notice.

o. r. = on request

SK Heat-shrink 3:1 - with interior adhesive

Polyolefin - thin - walled

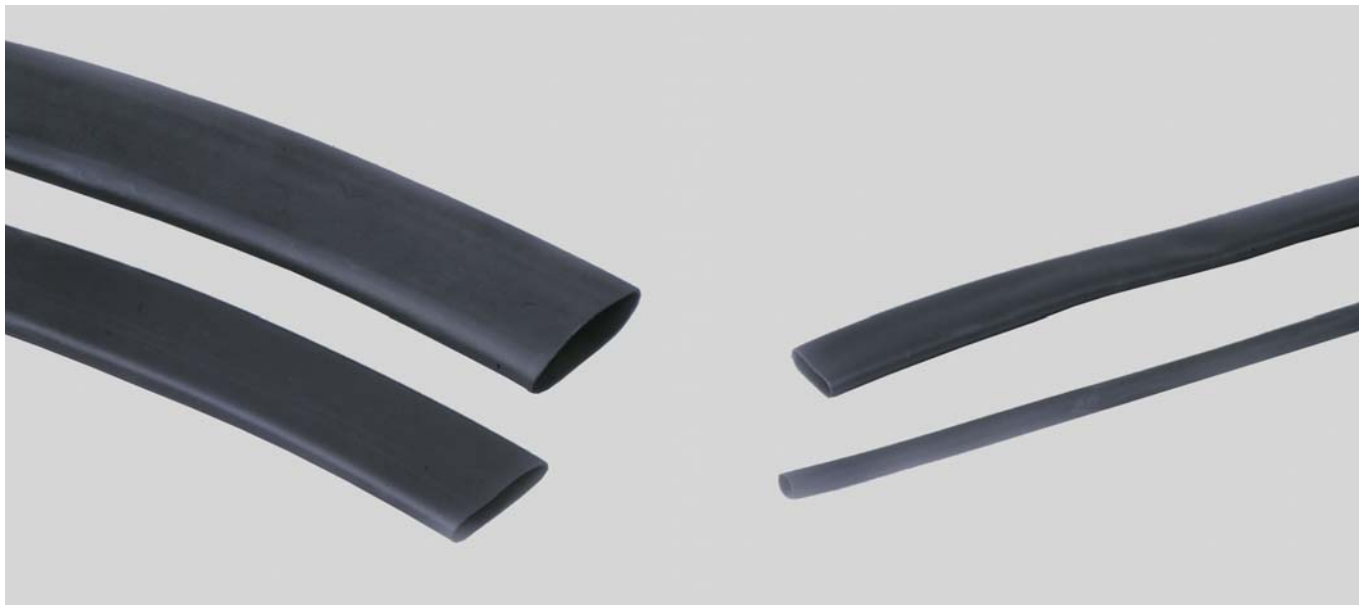

SK

Polyolefin shrink tube with internal adhesive for repairing insulation and sealing electrical components.

Application

- Plant and machine construction
- Robotics
- Automation technology
- Vehicle construction and shipbuilding
- Installation technology
- Control cabinet construction

Material

PO (Polyolefin) with internal adhesive

Colour: black

Note

Form of shipment:
Box

Technical data

Temperature range: -55°C up to +110°C

Black

Part no.	Inner Ø before shrinkage mm	Wall thickness mm	Inner Ø after shrinkage mm	Content m	Unit	Net EUR/item at a purchase of up to 5	6 - 10	11 - 20
98258	3,2	1,0	1,0	5,0	1	o. r.	o. r.	o. r.
98259	6,4	1,0	2,0	3,5	1	o. r.	o. r.	o. r.
98260	9,5	1,5	3,2	3,0	1	o. r.	o. r.	o. r.
98261	12,7	1,8	4,1	2,5	1	o. r.	o. r.	o. r.
98262	19,1	1,8	6,4	2,0	1	o. r.	o. r.	o. r.
98263	25,4	2,5	8,1	1,5	1	o. r.	o. r.	o. r.

Dimensions and specifications may be changed without prior notice.

o. r. = on request

SK-M Shrink on tube 3:1 with interior adhesive

Polyolefin - medium walled

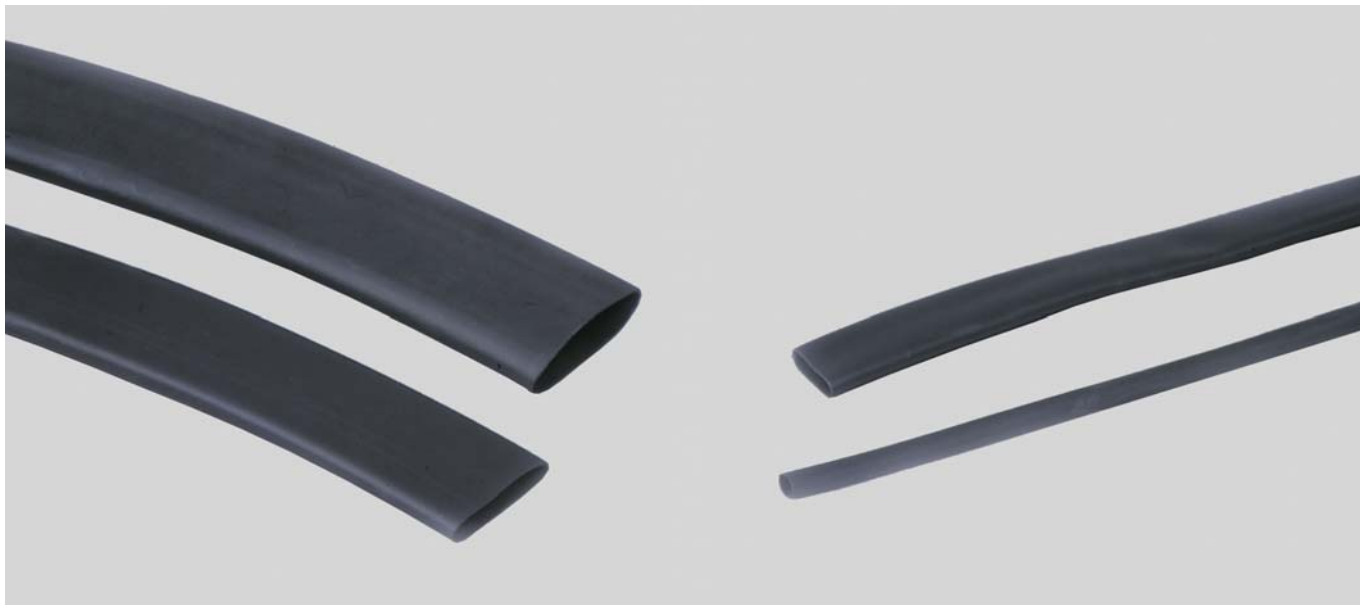

SK-M

Polyolefin shrink tube with internal adhesive for repairing insulation and sealing electrical components.

Application

- Plant and machine construction
- Robotics
- Automation technology
- Vehicle construction and shipbuilding
- Installation technology
- Control cabinet construction

Material

PO (Polyolefin) with internal adhesive

Colour: black

Note

Form of shipment:
1.2 m rods

Technical data

Temperature range: -55°C up to +110°C

Black

Part no.	Inner Ø before shrinkage mm	Wall thickness mm	Inner Ø after shrinkage mm	Content m	Unit	Net EUR/100 items at a purchase of		
						up to 5	6 - 10	11 - 20
99788	10,2	2,0	3,8	rods of 1,22m	1	o. r.	o. r.	o. r.
99789	19,1	2,0	5,6	rods of 1,22m	1	o. r.	o. r.	o. r.
99790	27,9	2,0	10,2	rods of 1,22m	1	o. r.	o. r.	o. r.
99791	33,0	2,0	10,2	rods of 1,22m	1	o. r.	o. r.	o. r.
99792	38,1	2,0	12,7	rods of 1,22m	1	o. r.	o. r.	o. r.
99793	43,2	2,0	12,7	rods of 1,22m	1	o. r.	o. r.	o. r.
99794	52,1	2,0	19,0	rods of 1,22m	1	o. r.	o. r.	o. r.
99795	69,9	2,0	25,0	rods of 1,22m	1	o. r.	o. r.	o. r.
99796	88,9	2,4	30,0	rods of 1,22m	1	o. r.	o. r.	o. r.
99797	119,4	2,7	40,0	rods of 1,22m	1	o. r.	o. r.	o. r.
99798	152,0	2,8	48,0	rods of 1,22m	1	o. r.	o. r.	o. r.
99799	170,2	2,8	58,0	rods of 1,22m	1	o. r.	o. r.	o. r.
99678	228,6	3,0	77,0	rods of 1,22m	1	o. r.	o. r.	o. r.

Dimensions and specifications may be changed without prior notice.

o. r. = on request

SK-D Heat shrink 3:1 - with interior adhesive

Polyolefin - thick walled

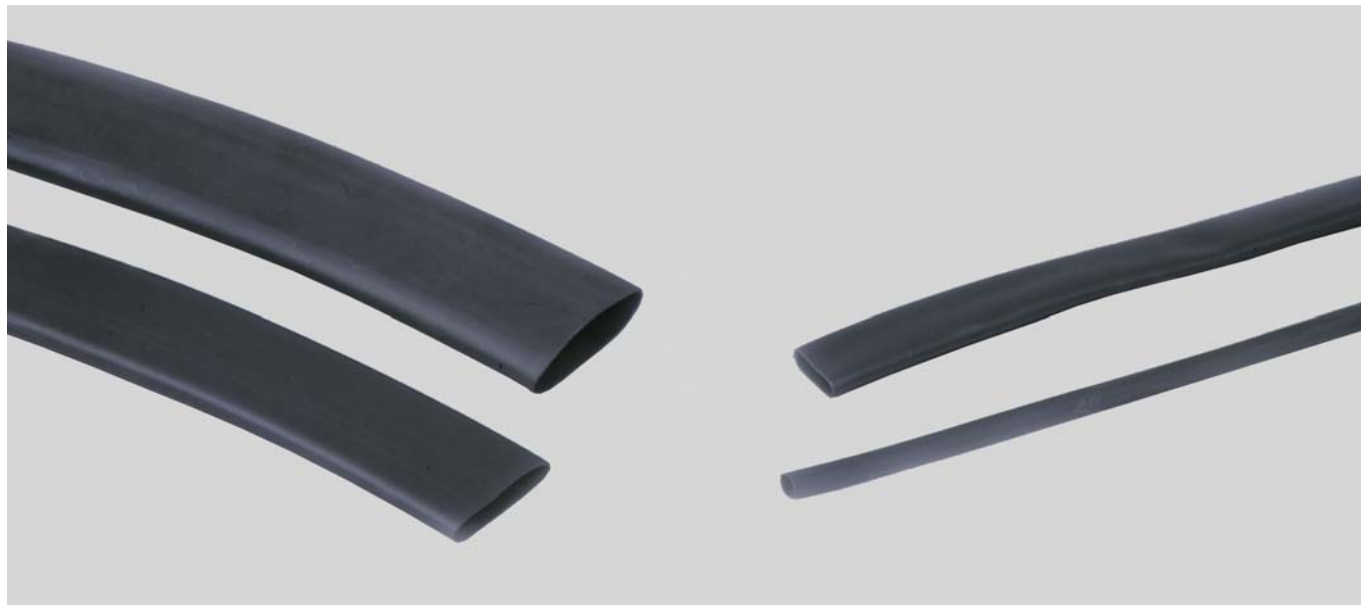

SK-D

Polyolefin shrink tube with internal adhesive for repairing insulation and sealing electrical components.

For the protection of cable sleeves and terminations for low-voltage applications (600V).

Good protection against impact and abrasion.

Application

- Plant and machine construction
- Robotics
- Automation technology
- Vehicle construction and shipbuilding
- Installation technology
- Control cabinet construction

Material

PO (Polyolefin) with internal adhesive

Colour: black

- halogen-free

Note

Form of shipment:

1.2 m rods

Approval:

UR-listed up to size 68,1mm

Technical data

Temperature range: -55°C up to +110°C

black

Part no.	Inner Ø before shrinkage mm	Wall thickness mm	Inner Ø after shrinkage mm	Content m	Unit	Net EUR/100 items at a purchase of		
						up to 5	6 - 10	11 - 20
905344	8,9	1,8	3,0	rods of 1,22m	1	o. r.	o. r.	o. r.
905335	13,0	2,4	4,1	rods of 1,22m	1	o. r.	o. r.	o. r.
905336	19,1	2,4	6,1	rods of 1,22m	1	o. r.	o. r.	o. r.
905337	27,9	3,0	8,9	rods of 1,22m	1	o. r.	o. r.	o. r.
905338	38,1	4,1	11,9	rods of 1,22m	1	o. r.	o. r.	o. r.
905339	50,8	4,1	16,0	rods of 1,22m	1	o. r.	o. r.	o. r.
905340	68,1	4,1	22,1	rods of 1,22m	1	o. r.	o. r.	o. r.
905731	89,9	4,1	30,0	rods of 1,22m	1	o. r.	o. r.	o. r.
905732	119,9	2,0	39,9	rods of 1,22m	1	o. r.	o. r.	o. r.

Dimensions and specifications may be changed without prior notice.

o. r. = on request

SVRO Heat shrink 2:1 - high resistant

FKM



SVRO

FKM shrink tube to protect against aggressive media.

Application

- Plant and machine construction
- Robotics
- Automation technology
- Vehicle construction and shipbuilding
- Installation technology
- Control cabinet construction

Material

FKM

Colour: black

Properties

Weather, flame and chemical resistant

Note

MIL-I-23053

Technical data

Temperature range: -55°C up to +220°C

Black

Part no.	Inner Ø before shrinkage mm	Wall thickness mm	Inner Ø after shrinkage mm	Content m	Unit	Net EUR/ 100 metres at a purchase of		
						up to 100	101 - 500	501 - 1000
96796	3,2	0,8	1,6	50,0	-	o. r.	o. r.	o. r.
97385	4,8	0,9	2,4	50,0	-	o. r.	o. r.	o. r.
97774	6,4	0,9	3,2	50,0	-	o. r.	o. r.	o. r.
91165	9,5	1,0	4,8	50,0	-	o. r.	o. r.	o. r.
91166	12,7	1,2	6,4	30,0	-	o. r.	o. r.	o. r.
93690	19,0	1,4	9,5	30,0	-	o. r.	o. r.	o. r.
93691	25,4	1,8	12,7	30,0	-	o. r.	o. r.	o. r.
93692	38,0	2,4	19,0	15,0	-	o. r.	o. r.	o. r.
93693	50,8	2,8	25,4	15,0	-	o. r.	o. r.	o. r.

Dimensions and specifications may be changed without prior notice.

o. r. = on request

EKI End caps 2:1

Polyethylene



EKI

End caps with internal adhesive protect cable ends from the ingress of water.

Application

- Plant and machine construction
- Robotics
- Automation technology
- Vehicle construction and shipbuilding
- Railway technology
- Installation technology
- Control cabinet construction

Material

Polyethylene

Colour: black

Properties

Weather-resistant

Technical data

Temperature range: -40°C up to +70°C

Black

Part no.	Inner Ø before shrinkage mm	Length mm	Inner Ø after shrinkage mm	Unit	Net EUR/100 items at a purchase of		
					up to 100	101 - 500	501 - 1000
97642	12,0	35	4,0	10	o. r.	o. r.	o. r.
97782	13,0	30	6,5	10	o. r.	o. r.	o. r.
98264	22,0	60	8,0	10	o. r.	o. r.	o. r.
97643	20,0	65	10,0	10	o. r.	o. r.	o. r.
97644	20,0	125	9,0	10	o. r.	o. r.	o. r.
97783	40,0	85	15,0	10	o. r.	o. r.	o. r.
97645	35,0	90	17,5	5	o. r.	o. r.	o. r.
97812	50,0	125	25,0	5	o. r.	o. r.	o. r.
97648	55,0	125	22,0	2	o. r.	o. r.	o. r.
97784	75,0	120	43,0	2	o. r.	o. r.	o. r.
97649	75,0	120	34,0	2	o. r.	o. r.	o. r.
97650	75,0	200	34,0	2	o. r.	o. r.	o. r.
98265	100,0	120	42,0	2	o. r.	o. r.	o. r.
97652	100,0	130	59,0	1	o. r.	o. r.	o. r.
97651	100,0	225	59,0	1	o. r.	o. r.	o. r.
97653	115,0	140	59,0	1	o. r.	o. r.	o. r.
98266	125,0	130	70,0	1	o. r.	o. r.	o. r.
97654	145,0	155	71,0	1	o. r.	o. r.	o. r.

Dimensions and specifications may be changed without prior notice.

o. r. = on request

MSVM-S

IREV-S

KMRS

NSVM-S

FLEV-A

HSIB

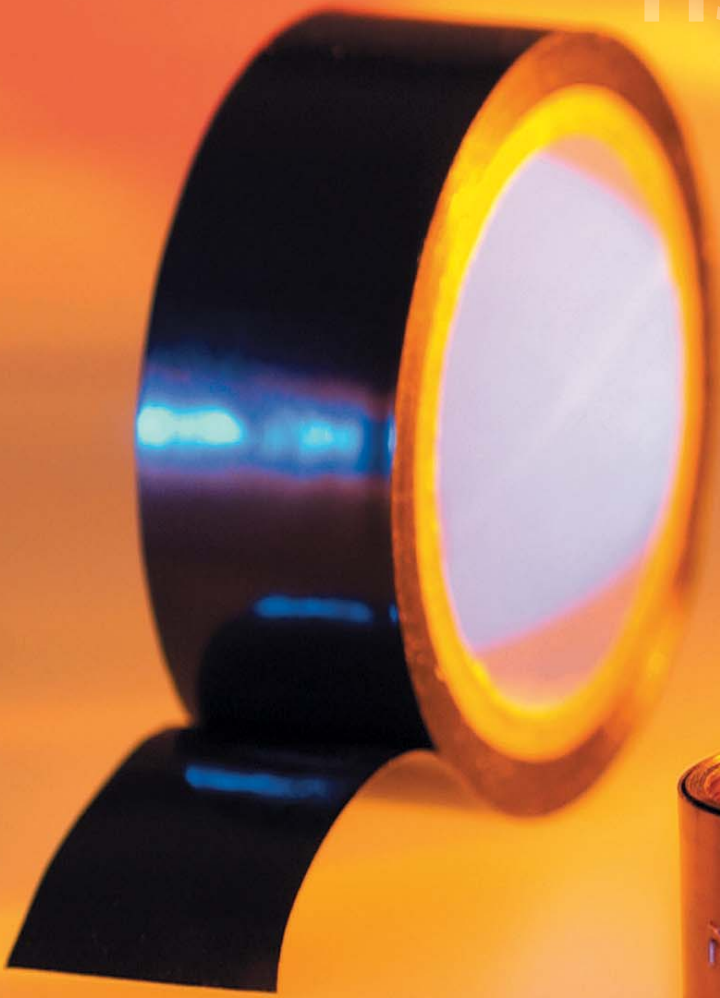

■ END CAPS AND CORE END SLEEVES

Series/Material	Application area	Item	Page
Telecommunication cables			
Sleeves	Core end sleeves for telecommunication cables	Mff VASMI	328
Core connector	Core connectors for telecommunications cables and signal cables	AV core connector	329
Low-voltage			
Shrinking	Low-voltage connection sleeves NSVM-S	NSVM-S single core	330
	Low-voltage connection sleeves NSVM-S	NSVM-S multi core	331
	Low-voltage connection sleeves NSVM-S	NSVM-S E90	332
Medium-voltage			
Shrinking	Medium voltage connection sleeve MSVM-S	MSVM-S single core	333
	Medium voltage connection sleeve MSVM-S	MSVM-S triple core	334
	Indoor end closure IREV-S	IREV-S single and triple core	335
	Outdoor end closure FLEV-S	FLEV-S single and triple core	336
Push-on	Medium voltage connection sleeves MSVM-A	MSVM-A single core	337
	End cap - Indoor/Outdoor	IREV-A, FLEV-A	338
Accessories / Parts			
Accessories	Medium voltage accessories	KMRS repair set	339
		LG sealant	339
		Sealing tape	339
		HSIB High voltage insulating tape	340
		Warning tape	340

MfF VASMI - Sleeve for telephone cable



MfF

Connection and branch sleeve for telecommunication cables. For connecting telecommunication cables and producing cable branch lines for telecommunication cables.

Application

- Outdoors
- Indoors
- Underground
- Water

Properties

- high electrical insulation values
- water-tight and moisture-protected
- good mechanical strength
- highly resistant to UV radiation, earth alkalis and chemical influences
- with temperature indicator colour
- suitable for cut and uncut cables
- dismantlable
- unlimited storage

Scope of delivery

- shield bonding lead with special clamp
- desiccant
- protection inlay
- flame protection film
- shrink-on sleeve
- insulating band
- cleaning agent
- sanding
- assembly instruction

Part no.	Type	Length mm	Cable Ø from - to mm	Spliced with core connectors 0,4 mm Number of two cores	Spliced with core connectors 0,6 mm Number of two cores	Spliced with core connectors 0,8 mm Number of two cores	Net EUR/item at a purchase of		
							1	2 - 5	6 - 10
94330	VASMI 1 SRT	330	8,0 - 35,0	30	20	10	o. r.	o. r.	o. r.
94331	VASMI 1/L SRT	390	8,0 - 35,0	70	40	20	o. r.	o. r.	o. r.
94332	VASMI 2 SRT	380	15,0 - 55,0	100	50	30	o. r.	o. r.	o. r.
94333	VASMI 2/L SRT	450	15,0 - 55,0	150	100	50	o. r.	o. r.	o. r.
94334	VASMI 3 SRT	400	25,0 - 68,0	150	100	70	o. r.	o. r.	o. r.
94335	VASMI 3/L SRT	500	25,0 - 68,0	200	200	100	o. r.	o. r.	o. r.
94336	VASMI 4 SRT	430	28,0 - 94,0	200	200	150	o. r.	o. r.	o. r.
94337	VASMI 5 SRT	600	28,0 - 94,0	400	300	200	o. r.	o. r.	o. r.
94338	VASMI 6 SRT	725	34,0 - 101,0	600	500	300	o. r.	o. r.	o. r.

Dimensions and specifications may be changed without prior notice.

o. r. = on request

AV Core connectors for communication and signal cables

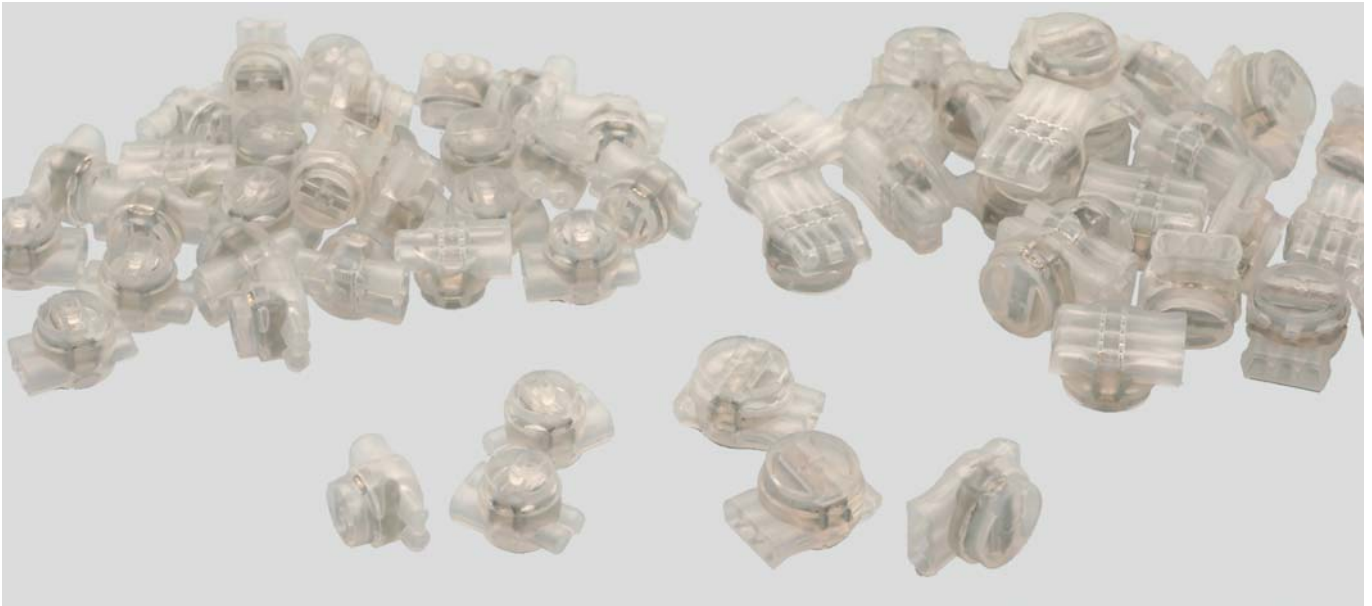

AV core connectors

Core connectors type **AV** connect plastic-insulated telecommunication and signal cable cores. They are characterised by their space-saving and assembly-friendly structure. Satisfy the requirements of DIN 47627 (solder-free core connections in sleeves for telecommunication cables).

When clamping with the **AVZ** tool, the vertical forces are transferred evenly to the core connectors, thus guaranteeing reliable contacting of the copper wires to be processed.

Properties

- high electrical insulation values
- high mechanical and thermal strength
- impact-proof plastic housing
- corrosion protection through grease charge
- improved contacting through U-contact principle
- core diameters up to 2.0 mm possible
- larger application range from 0.4 - 0.9 mm conductor diameter
- stripping, connection and insulation in one action

Scope of delivery

Colour: transparent

Note

The parallel-clamping core binding pliers or equivalent are suitable for flush clamping core connectors.

Use core connection pliers AVZ or equal tool.

AV core connectors

Part no.	Type	No. cores	Conductor Ø from - to mm	Unit	Net EUR/ 100 items at a purchase of		
					up to 500	501 - 1000	1001 - 5000
93147	AV2	2	0,4 - 0,9	100	o. r.	o. r.	o. r.
93148	AV3	3	0,4 - 0,9	100	o. r.	o. r.	o. r.
93149	AVT3	3	0,4 - 0,9	100	o. r.	o. r.	o. r.

AVZ core connecting pliers

Part no.	Type	No. cores	Conductor Ø from - to mm	Unit	Net EUR/item at a purchase of		
					1	2 - 5	6 - 10
93150	AVZ	-	-	1	o. r.	o. r.	o. r.

Dimensions and specifications may be changed without prior notice.

o. r. = on request

NSVM-S Low voltage heat-shrinkable straight joint

Single core



NSVM-S (single-core straight joint)

Straight joint for single-core plastic-insulated power cables to 0.6/1(1.2)kV, universal applications for connecting cables and wires made of PVC, PE and VPE, e.g. N(A)YY, N(A)2XY, NYM, NYY.

Application

- Interior
- Outdoors
- Underground
- Water

Properties

- halogen-free
- high electrical insulation values
- laterally water-tight
- good mechanical strength
- compact dimensions
- unlimited storage
- large wire and cable cross-sections
- highly resistant to chemical influences, alkaline earths and UV radiation

Scope of delivery

- inner seal
- outer seal
- illustrated assembly instruction

Test

According to CENELEC HD 623 (VDE0278,Part623)

Single core

Part no.	Type	Nominal voltage U _o /U(U _m)	Cross-section mm ²	Unit	Net EUR/item at a purchase of		
					1	2 - 5	6 - 10
93890	NSVM-S1	0.6/1kV	1x 10,0 - 1x 25,0	1	o. r.	o. r.	o. r.
93891	NSVM-S1	0.6/1kV	1x 35,0 - 1x 70,0	1	o. r.	o. r.	o. r.
93892	NSVM-S1	0.6/1kV	1x 95,0 - 1x 240,0	1	o. r.	o. r.	o. r.
93893	NSVM-S1	0.6/1kV	1x 150,0 - 1x 300,0	1	o. r.	o. r.	o. r.
93894	NSVM-S1	0.6/1kV	1x 300,0 - 1x 500,0	1	o. r.	o. r.	o. r.

Dimensions and specifications may be changed without prior notice.

o. r. = on request

NSVM-S Low voltage heat-shrinkable straight joint

Multi core



NSVM-S (multi-core straight joint)

Straight joint for multi-core plastic-insulated power cables to 0.6/1 (1.2)kV, universal applications for connecting cables and wires from PVC, PE and VPE, e.g. N(A)YY, N(A)2XY, N(A)YCWY, NYM, NYY.

Application

- Indoors
- Outdoors
- Underground
- Water

Properties

- halogen-free
- high electrical insulation values
- laterally water-tight
- good mechanical strength
- compact dimensions
- unlimited storage
- large wire and cable cross-sections
- highly resistant to chemical influences, earth alkalis and UV radiation

Scope of delivery

- inner seal
- outer seal
- illustrated assembly instruction

Test

According to CENELEC HD 623 (VDE0278,Part623)

Multiple core

Part no.	Type	Nominal voltage Uo/U(Um)	Cross-section mm ²	Unit	Net EUR/item at a purchase of		
					1	2 - 5	6 - 10
94400	NSVM-S3	0.6/1kV	3x 1,5 - 3x 16,0	1	o. r.	o. r.	o. r.
94401	NSVM-S3	0.6/1kV	3x 6,0 - 3x 25,0	1	o. r.	o. r.	o. r.
94402	NSVM-S3	0.6/1kV	3x 25,0 - 3x 70,0	1	o. r.	o. r.	o. r.
94403	NSVM-S3	0.6/1kV	3x 95,0 - 3x 150,0	1	o. r.	o. r.	o. r.
94404	NSVM-S3	0.6/1kV	3x 185,0 - 3x 300,0	1	o. r.	o. r.	o. r.
93382	NSVM-S4	0.6/1kV	4x 1,5 - 4x 6,0	1	o. r.	o. r.	o. r.
93388	NSVM-S4	0.6/1kV	4x 1,5 - 4x 16,0	1	o. r.	o. r.	o. r.
93383	NSVM-S4	0.6/1kV	4x 6,0 - 4x 25,0	1	o. r.	o. r.	o. r.
93384	NSVM-S4	0.6/1kV	4x 16,0 - 4x 50,0	1	o. r.	o. r.	o. r.
93385	NSVM-S4	0.6/1kV	4x 25,0 - 4x 95,0	1	o. r.	o. r.	o. r.
93386	NSVM-S4	0.6/1kV	4x 25,0 - 4x 150,0	1	o. r.	o. r.	o. r.
93389	NSVM-S4	0.6/1kV	4x 95,0 - 4x 300,0	1	o. r.	o. r.	o. r.
94405	NSVM-S5	0.6/1kV	5x 1,5 - 5x 6,0	1	o. r.	o. r.	o. r.
94406	NSVM-S5	0.6/1kV	5x 1,5 - 5x 10,0	1	o. r.	o. r.	o. r.
94407	NSVM-S5	0.6/1kV	5x 1,5 - 5x 16,0	1	o. r.	o. r.	o. r.
94408	NSVM-S5	0.6/1kV	5x 16,0 - 5x 25,0	1	o. r.	o. r.	o. r.

Dimensions and specifications may be changed without prior notice.

o. r. = on request

NSVM-S E90 Low voltage heat-shrinkable straight joint



NSVM-S E90

Flame-resistant heat-shrinkable low-voltage connecting sleeve. For connection type (N)HX(HX) and (N)HXCHX safety cables wherever specified.

Application

Power stations, tunnels, airports, elevators, stairways etc.

Properties

- flame-resistant
- halogen-free
- very low flue gas
- self-extinguishing
- suitable for all installation types

Scope of delivery

- inner seal
- insulation tube
- outer seal
- illustrated assembly instruction

Test

DIN4102, part 12,
draft february 1996 (E90)
DIN VDE 0472, part 814 (FE 180)
IEC 332

For cable type (N) HXHX

Part no.	Type	Nominal voltage U _o /U(U _m)	Cross-section mm ²	Unit	Net EUR/item at a purchase of		
					1	2 - 5	6 - 10
94460	NSVM-SE4	0.6/1kV	4x 1,5 - 4x 4,0	1	o. r.	o. r.	o. r.
94461	NSVM-SE4	0.6/1kV	4x 6,0 - 4x 10,0	1	o. r.	o. r.	o. r.
94462	NSVM-SE4	0.6/1kV	4x 16,0 - 4x 25,0	1	o. r.	o. r.	o. r.
94463	NSVM-SE4	0.6/1kV	4x 35,0 - 4x 50,0	1	o. r.	o. r.	o. r.
94464	NSVM-SE4	0.6/1kV	4x 70,0 - 4x 95,0	1	o. r.	o. r.	o. r.
94465	NSVM-SE4	0.6/1kV	4x 120,0 - 4x 150,0	1	o. r.	o. r.	o. r.
94466	NSVM-SE4	0.6/1kV	4x 185,0 - 4x 240,0	1	o. r.	o. r.	o. r.
94467	NSVM-SE5	0.6/1kV	5x 1,5 - 5x 4,0	1	o. r.	o. r.	o. r.
94468	NSVM-SE5	0.6/1kV	5x 6,0 - 5x 10,0	1	o. r.	o. r.	o. r.
94469	NSVM-SE5	0.6/1kV	5x 16,0 - 5x 25,0	1	o. r.	o. r.	o. r.

For cable type (N) HXCHX

Part no.	Type	Nominal voltage U _o /U(U _m)	Cross-section mm ²	Unit	Net EUR/item at a purchase of		
					1	2 - 5	6 - 10
94470	NSVM-SE4/1	0.6/1kV	4x 1,5 / 1,5 - 4x 4,0 / 4,0	1	o. r.	o. r.	o. r.
94471	NSVM-SE4/1	0.6/1kV	4x 6,0 / 6,0 - 4x 10,0 / 10,0	1	o. r.	o. r.	o. r.
94472	NSVM-SE4/1	0.6/1kV	4x 16,0 / 16,0 - 4x 25,0 / 16,0	1	o. r.	o. r.	o. r.
94473	NSVM-SE4/1	0.6/1kV	4x 35,0 / 16,0 - 4x 50,0 / 25,0	1	o. r.	o. r.	o. r.
94474	NSVM-SE4/1	0.6/1kV	4x 70,0 / 35,0 - 4x 95,0 / 50,0	1	o. r.	o. r.	o. r.
94475	NSVM-SE4/1	0.6/1kV	4x 120,0 / 70,0 - 4x 150,0 / 70,0	1	o. r.	o. r.	o. r.
94476	NSVM-SE4/1	0.6/1kV	4x 185,0 / 95,0 - 4x 240,0 / 120,0	1	o. r.	o. r.	o. r.

Dimensions and specifications may be changed without prior notice.

o. r. = on request

MSVM-S Medium voltage heat-shrinkable straight joint

Single core



MSVM-S

Medium voltage connection sleeve for connecting all single-core plastic power cables with external conductor layer up to 18/30(36)kV.

For connecting cables with different cross-sections, conductor materials and cable designs with regard to external conductor layer and sheathing.

Properties

- safe field effect
- simple assembly
- large cross-sections
- unlimited conductivity
- immediately operational

Scope of delivery

- packing unit: 1
- two suspensible silicon control elements
- field effect filler tape (blue)
- thick-walled heat shrink tube
- copper fabric shielding
- heat shrink tube as oversheath
- assembly instruction

Single core

Part no.	Type	Nominal voltage U ₀ /U(U _m)	Cross-section mm ²	Diameter from - to mm	Unit	Net EUR/item at a purchase of		
						1	2 - 5	6 - 10
93107	MSVM-S12/1	6/10kV	35,0 - 95,0	13,2 - 20,0	1	o. r.	o. r.	o. r.
93108	MSVM-S12/1	6/10kV	95,0 - 240,0	18,2 - 25,0	1	o. r.	o. r.	o. r.
93109	MSVM-S12/1	6/10kV	150,0 - 300,0	20,9 - 35,0	1	o. r.	o. r.	o. r.
93110	MSVM-S12/1	6/10kV	300,0 - 400,0	28,6 - 45,0	1	o. r.	o. r.	o. r.
93111	MSVM-S12/1	6/10kV	500,0 - 800,0	28,6 - 60,0	1	o. r.	o. r.	o. r.
93117	MSVM-S24/1	12/20kV	10,0 - 35,0	13,2 - 15,0	1	o. r.	o. r.	o. r.
93118	MSVM-S24/1	12/20kV	50,0 - 150,0	18,2 - 25,0	1	o. r.	o. r.	o. r.
93119	MSVM-S24/1	12/20kV	70,0 - 240,0	20,9 - 30,0	1	o. r.	o. r.	o. r.
93120	MSVM-S24/1	12/20kV	150,0 - 300,0	24,2 - 35,0	1	o. r.	o. r.	o. r.
93379	MSVM-S24/1	12/20kV	400,0 - 630,0	28,6 - 45,0	1	o. r.	o. r.	o. r.
93398	MSVM-S24/1	12/20kV	630,0 - 1000,0	28,6 - 45,0	1	o. r.	o. r.	o. r.
93121	MSVM-S36/1	18/30kV	35,0 - 70,0	20,9 - 18,0	1	o. r.	o. r.	o. r.
93122	MSVM-S36/1	18/30kV	50,0 - 150,0	24,2 - 25,0	1	o. r.	o. r.	o. r.
93123	MSVM-S36/1	18/30kV	150,0 - 300,0	28,6 - 35,0	1	o. r.	o. r.	o. r.
93124	MSVM-S36/1	18/30kV	300,0 - 500,0	28,6 - 45,0	1	o. r.	o. r.	o. r.

Dimensions and specifications may be changed without prior notice.

o. r. = on request

MSVM-S Medium voltage heat-shrinkable straight joint

Triple core



MSVM-S

Medium voltage connection sleeve for connecting all 3-core plastic power cables with external conductor layer up to 18/30(36)kV. For connecting cables with differing cross-sections, conductor materials and cable designs with regard to external conductor layer and sheathing.

Special solutions enable a 3-core plastic power cable to be connected to 3 single-core plastic power cables.

Properties

- safe field effect
- simple assembly
- large cross-sections
- unlimited conductivity
- immediately operational

Scope of delivery

- packing unit: 1
- two suspensible silicon control elements
- field effect filler tape (blue)
- thick-walled heat shrink tube
- copper fabric shielding
- heat shrink tube as overshooth
- assembly instruction

Triple core

Part no.	Type	Nominal voltage U ₀ /U(U _m)	Cross-section mm ²	Diameter from - to mm	Unit	Net EUR/item at a purchase of		
						1	2 - 5	6 - 10
93135	MSVM-S12/3	6/10kV	3x 10,0 - 3x 25,0	13,2 - 20,0	1	o. r.	o. r.	o. r.
93136	MSVM-S12/3	6/10kV	3x 35,0 - 3x 95,0	18,2 - 25,0	1	o. r.	o. r.	o. r.
93137	MSVM-S12/3	6/10kV	3x 95,0 - 3x 240,0	20,9 - 35,0	1	o. r.	o. r.	o. r.
93142	MSVM-S24/3	12/20kV	3x 10,0 - 3x 35,0	13,2 - 15,0	1	o. r.	o. r.	o. r.
93143	MSVM-S24/3	12/20kV	3x 50,0 - 3x 150,0	18,2 - 25,0	1	o. r.	o. r.	o. r.
93144	MSVM-S24/3	12/20kV	3x 70,0 - 3x 240,0	20,9 - 30,0	1	o. r.	o. r.	o. r.
93145	MSVM-S24/3	12/20kV	3x 150,0 - 3x 300,0	24,2 - 35,0	1	o. r.	o. r.	o. r.
93186	MSVM-S36/3	18/30kV	3x 35,0 - 3x 70,0	20,9 - 18,0	1	o. r.	o. r.	o. r.
93187	MSVM-S36/3	18/30kV	3x 50,0 - 3x 150,0	24,2 - 25,0	1	o. r.	o. r.	o. r.
93188	MSVM-S36/3	18/30kV	3x 150,0 - 3x 300,0	28,6 - 35,0	1	o. r.	o. r.	o. r.

Triple core - special solutions

Part no.	Type	Nominal voltage U ₀ /U(U _m)	Cross-section mm ²	Diameter from - to mm	Unit	Net EUR/item at a purchase of		
						1	2 - 5	6 - 10
93138	MSVM-S12/3 S	6/10kV	3x 35,0 - 3x 70,0	13,2 - 20,0	1	o. r.	o. r.	o. r.
93139	MSVM-S12/3 S	6/10kV	3x 95,0 - 3x 150,0	18,2 - 25,0	1	o. r.	o. r.	o. r.
93140	MSVM-S12/3 S	6/10kV	3x 185,0 - 3x 300,0	20,9 - 35,0	1	o. r.	o. r.	o. r.

Dimensions and specifications may be changed without prior notice.

o. r. = on request

IREV-S Indoor termination, shrink type



IREV-S

Interior end seals for all single-conductor and three-conductor.

Medium voltage plastic cables with layers and screen designs up to 18/30(36)kV.

Properties

- safe field effect
- simple assembly
- wide application range
- excellent external layer behaviour
- unlimited conductivity
- immediately operational

Scope of delivery

- packing unit: 1
- suspensible silicon control element
- sealing band
- creeping current resistant, weather-proof heat shrink tube
- assembly instruction
- suspensible silicone sheds

Note

- An additional earthing kit is required for cables with copper sheath.
- Without terminals.
- 1 unit = 1 set with 3 items.

Single core

Part no.	Type	Nominal voltage U _o /U(U _m)	Cross-section mm ²	Unit	Net EUR/item at a purchase of		
					1	2 - 5	6 - 10
93190	IREV-S12/1	6/10kV	10,0 - 25,0	1	o. r.	o. r.	o. r.
93191	IREV-S12/1	6/10kV	25,0 - 95,0	1	o. r.	o. r.	o. r.
94420	IREV-S12/1	6/10kV	95,0 - 240,0	1	o. r.	o. r.	o. r.
93192	IREV-S12/1	6/10kV	150,0 - 400,0	1	o. r.	o. r.	o. r.
93193	IREV-S12/1	6/10kV	240,0 - 500,0	1	o. r.	o. r.	o. r.
94421	IREV-S12/1	6/10kV	400,0 - 800,0	1	o. r.	o. r.	o. r.
94422	IREV-S12/1	6/10kV	800,0 - 1000,0	1	o. r.	o. r.	o. r.
94423	IREV-S24/1	12/20kV	10,0 - 35,0	1	o. r.	o. r.	o. r.
93194	IREV-S24/1	12/20kV	25,0 - 150,0	1	o. r.	o. r.	o. r.
93195	IREV-S24/1	12/20kV	70,0 - 240,0	1	o. r.	o. r.	o. r.
93196	IREV-S24/1	12/20kV	120,0 - 300,0	1	o. r.	o. r.	o. r.
93197	IREV-S24/1	12/20kV	240,0 - 500,0	1	o. r.	o. r.	o. r.
94424	IREV-S24/1	12/20kV	630,0 - 1000,0	1	o. r.	o. r.	o. r.
93198	IREV-S36/1	18/30kV	35,0 - 70,0	1	o. r.	o. r.	o. r.
94425	IREV-S36/1	18/30kV	50,0 - 150,0	1	o. r.	o. r.	o. r.
93199	IREV-S36/1	18/30kV	150,0 - 400,0	1	o. r.	o. r.	o. r.
93200	IREV-S36/1	18/30kV	500,0 - 800,0	1	o. r.	o. r.	o. r.

3-core

Part no.	Type	Nominal voltage U _o /U(U _m)	Cross-section mm ²	Unit	Net EUR/item at a purchase of		
					1	2 - 5	6 - 10
94435	IREV-S12/3	6/10kV	10,0 - 25,0	1	o. r.	o. r.	o. r.
93201	IREV-S12/3	6/10kV	25,0 - 95,0	1	o. r.	o. r.	o. r.
93202	IREV-S12/3	6/10kV	95,0 - 240,0	1	o. r.	o. r.	o. r.
93203	IREV-S12/3	6/10kV	150,0 - 400,0	1	o. r.	o. r.	o. r.
94436	IREV-S24/3	12/20kV	10,0 - 35,0	1	o. r.	o. r.	o. r.
94437	IREV-S24/3	12/20kV	25,0 - 95,0	1	o. r.	o. r.	o. r.
94438	IREV-S24/3	12/20kV	70,0 - 240,0	1	o. r.	o. r.	o. r.
94439	IREV-S24/3	12/20kV	120,0 - 300,0	1	o. r.	o. r.	o. r.

Dimensions and specifications may be changed without prior notice.

o. r. = on request

FLEV-S Outdoor termination, shrink type



FLEV-S

Outside end seals for all single-conductor and three-conductor medium voltage plastic cables with layers and screen designs up to 18/30(36)kV.

Properties

- safe field effect
- simple assembly
- wide application range
- excellent external layer behaviour
- unlimited conductivity
- immediately operational

Scope of delivery

- packing unit: 1
- suspensible silicon control element
- sealing band
- creeping current resistant, weather-proof heat shrink tube
- assembly instruction
- suspensible silicone sheds

Note

- An additional earthing kit is required for cables with copper sheath.
- Without terminals.
- 1 unit = 1 set with 3 items.

Single core

Part no.	Type	Nominal voltage U ₀ /U(U _m)	Cross-section mm ²	Unit	Net EUR/item at a purchase of		
					1	2 - 5	6 - 10
93360	FLEV-S12/1	6/10kV	10,0 - 25,0	1	o. r.	o. r.	o. r.
93361	FLEV-S12/1	6/10kV	25,0 - 95,0	1	o. r.	o. r.	o. r.
94426	FLEV-S12/1	6/10kV	95,0 - 240,0	1	o. r.	o. r.	o. r.
93362	FLEV-S12/1	6/10kV	150,0 - 400,0	1	o. r.	o. r.	o. r.
93363	FLEV-S12/1	6/10kV	240,0 - 500,0	1	o. r.	o. r.	o. r.
94427	FLEV-S12/1	6/10kV	400,0 - 800,0	1	o. r.	o. r.	o. r.
94428	FLEV-S12/1	6/10kV	800,0 - 1000,0	1	o. r.	o. r.	o. r.
94429	FLEV-S24/1	12/20kV	10,0 - 35,0	1	o. r.	o. r.	o. r.
93364	FLEV-S24/1	12/20kV	25,0 - 150,0	1	o. r.	o. r.	o. r.
93365	FLEV-S24/1	12/20kV	70,0 - 240,0	1	o. r.	o. r.	o. r.
93366	FLEV-S24/1	12/20kV	120,0 - 300,0	1	o. r.	o. r.	o. r.
93380	FLEV-S24/1	12/20kV	240,0 - 500,0	1	o. r.	o. r.	o. r.
94430	FLEV-S24/1	12/20kV	630,0 - 1000,0	1	o. r.	o. r.	o. r.
93367	FLEV-S36/1	18/30kV	35,0 - 70,0	1	o. r.	o. r.	o. r.
93368	FLEV-S36/1	18/30kV	50,0 - 150,0	1	o. r.	o. r.	o. r.
93369	FLEV-S36/1	18/30kV	150,0 - 400,0	1	o. r.	o. r.	o. r.
93370	FLEV-S36/1	18/30kV	500,0 - 800,0	1	o. r.	o. r.	o. r.

3-core

Part no.	Type	Nominal voltage U ₀ /U(U _m)	Cross-section mm ²	Unit	Net EUR/item at a purchase of		
					1	2 - 5	6 - 10
94443	FLEV-S12/3	6/10kV	10,0 - 25,0	1	o. r.	o. r.	o. r.
93371	FLEV-S12/3	6/10kV	25,0 - 95,0	1	o. r.	o. r.	o. r.
93372	FLEV-S12/3	6/10kV	95,0 - 240,0	1	o. r.	o. r.	o. r.
93373	FLEV-S12/3	6/10kV	150,0 - 400,0	1	o. r.	o. r.	o. r.
94444	FLEV-S24/3	12/20kV	10,0 - 35,0	1	o. r.	o. r.	o. r.
94445	FLEV-S24/3	12/20kV	25,0 - 95,0	1	o. r.	o. r.	o. r.
94446	FLEV-S24/3	12/20kV	70,0 - 240,0	1	o. r.	o. r.	o. r.
94447	FLEV-S24/3	12/20kV	120,0 - 300,0	1	o. r.	o. r.	o. r.

Dimensions and specifications may be changed without prior notice.

o. r. = on request

IREV-A, FLEV-A Termination with slip-on method

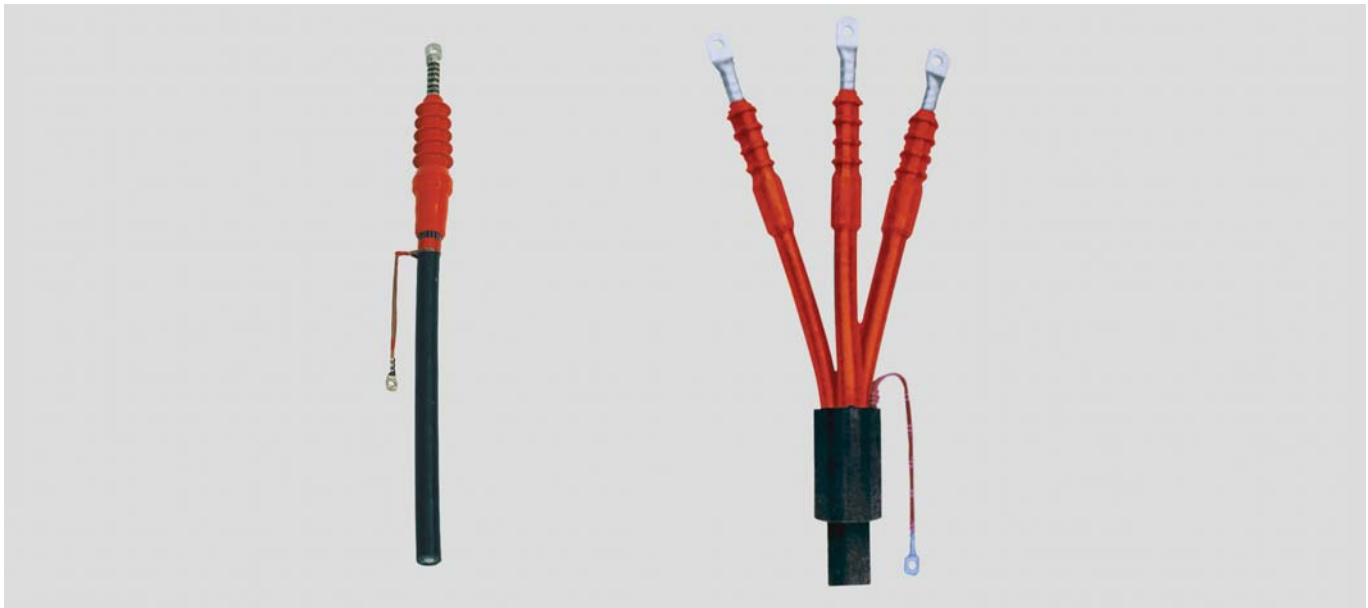

IREV-A/FLEV-A

Interior end seals and outside end seals in push-on technology for all single-conductor medium-range voltage plastic cables with differing conductor layers and sheath designs up to 18/30(36)kV.

Properties

- simple, quick assembly
- large cross-sections
- unlimited conductivity
- no pre-expansion
- no flame or heat source required
- immediately operational

Scope of delivery

- packing unit: 1
- one-piece suspensible silicon end lock
- integrated field control
- assembly instruction

IREV-A - indoor termination with slip-on method

Part no.	Type	Nominal voltage Uo/U(Um)	Cross-section mm ²	Unit	Net EUR/item at a purchase of		
					1	2 - 5	6 - 10
94371	IREV-A12	6/10kV	95,0 - 240,0	1	o. r.	o. r.	o. r.
94372	IREV-A12	6/10kV	150,0 - 400,0	1	o. r.	o. r.	o. r.
94373	IREV-A12	6/10kV	240,0 - 500,0	1	o. r.	o. r.	o. r.
94374	IREV-A12	6/10kV	300,0 - 800,0	1	o. r.	o. r.	o. r.
94375	IREV-A24	12/20kV	10,0 - 35,0	1	o. r.	o. r.	o. r.
94376	IREV-A24	12/20kV	35,0 - 120,0	1	o. r.	o. r.	o. r.
94377	IREV-A24	12/20kV	70,0 - 240,0	1	o. r.	o. r.	o. r.
94378	IREV-A24	12/20kV	120,0 - 400,0	1	o. r.	o. r.	o. r.
94379	IREV-A24	12/20kV	240,0 - 630,0	1	o. r.	o. r.	o. r.
94380	IREV-A36	18/30kV	16,0 - 95,0	1	o. r.	o. r.	o. r.
94381	IREV-A36	18/30kV	50,0 - 240,0	1	o. r.	o. r.	o. r.
94382	IREV-A36	18/30kV	120,0 - 400,0	1	o. r.	o. r.	o. r.

FLEV-A - outdoor termination with slip-on method

Part no.	Type	Nominal voltage Uo/U(Um)	Cross-section mm ²	Unit	Net EUR/item at a purchase of		
					1	2 - 5	6 - 10
94384	FLEV-A12	6/10kV	95,0 - 240,0	1	o. r.	o. r.	o. r.
94385	FLEV-A12	6/10kV	150,0 - 400,0	1	o. r.	o. r.	o. r.
94386	FLEV-A12	6/10kV	240,0 - 500,0	1	o. r.	o. r.	o. r.
94387	FLEV-A12	6/10kV	300,0 - 800,0	1	o. r.	o. r.	o. r.
94388	FLEV-A24	12/20kV	10,0 - 35,0	1	o. r.	o. r.	o. r.
94389	FLEV-A24	12/20kV	35,0 - 120,0	1	o. r.	o. r.	o. r.
94390	FLEV-A24	12/20kV	70,0 - 240,0	1	o. r.	o. r.	o. r.
94391	FLEV-A24	12/20kV	120,0 - 400,0	1	o. r.	o. r.	o. r.
94392	FLEV-A24	12/20kV	240,0 - 630,0	1	o. r.	o. r.	o. r.
94393	FLEV-A36	18/30kV	50,0 - 240,0	1	o. r.	o. r.	o. r.
94394	FLEV-A36	18/30kV	120,0 - 400,0	1	o. r.	o. r.	o. r.

Dimensions and specifications may be changed without prior notice.

o. r. = on request

Medium voltage accessories



Medium-range voltage accessories

KMRS: for a fast, reliable repair of sheath damage up to 1000 V. Consisting of cable sheath repair tape, emery cloth, cleaning cloth.

Sealant: for cable penetration, halogen-free dual-component PUR cast resin, practical dual chamber mixing bag.

Sealing tape, black: for sealing of cable and wire gussets, repair of damaged cable sheaths, water-tight sealing of cable penetrations.

Properties

KMRS: vulcanising, extremely good electrical properties; outstanding tensile strength, absolute moisture tight.

Sealant: good adhesion to metals, plastic, concrete, plastic and natural stones; removable, environmentally compatible, gas and water-tight to 1.5 bar, soft-elastic following hardening.

Sealing tape: very good adhesion to metal, glass, rubber, plastic, good dielectric and physical properties.

KMRS repair set

Part no.	Type	Description	Thickness x Width mm x mm	Content	Unit	Net EUR/item at a purchase of		
						1	2 - 5	6 - 10
93141	KMRS	Cable sheath repair set	-	Mixed bag	1	o. r.	o. r.	o. r.

LG sealing compound

Part no.	Type	Description	Thickness x Width mm x mm	Content	Unit	Net EUR/item at a purchase of		
						1	2 - 5	6 - 10
93125	Sealant	LG 250 (incl. spatula)	-	250,0 ml	1	o. r.	o. r.	o. r.
93126	Sealant	LG 500 (incl. spatula)	-	500,0 ml	1	o. r.	o. r.	o. r.

Sealing tape

Part no.	Type	Description	Thickness x Width mm x mm	Content	Unit	Net EUR/item at a purchase of		
						1	2 - 5	6 - 10
93127	Sealing tape	-	3,2 x 38,0	1,5 m	1	o. r.	o. r.	o. r.

Dimensions and specifications may be changed without prior notice.

o. r. = on request

Medium voltage accessories

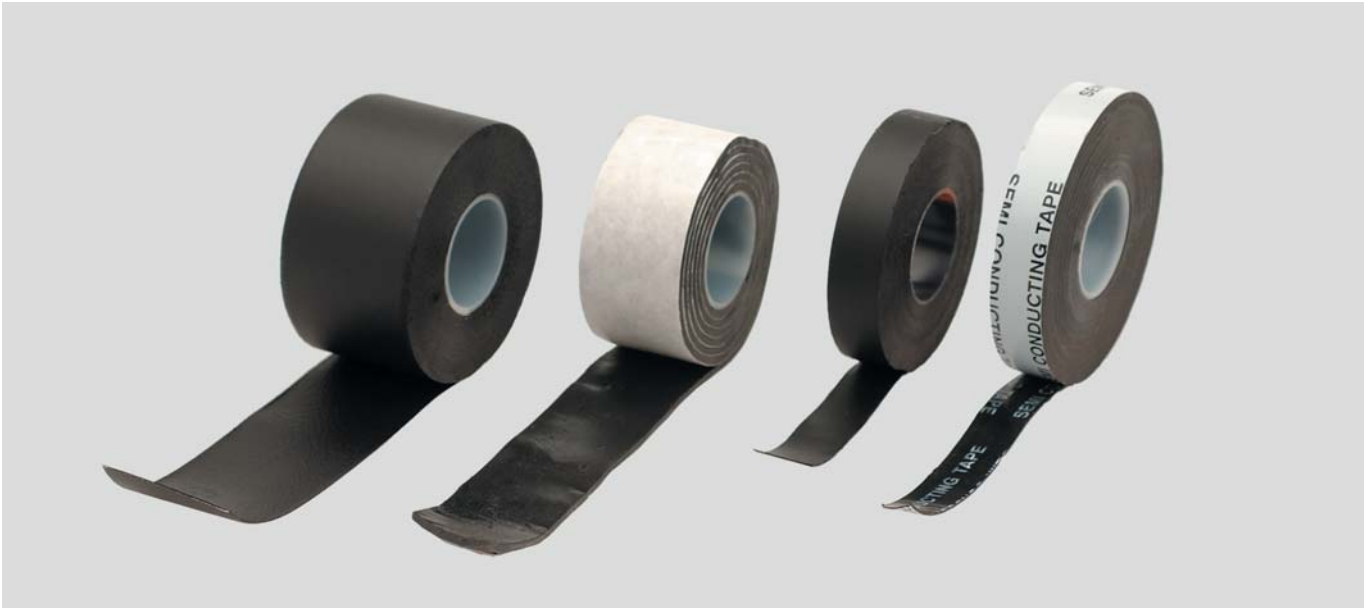

Medium-range voltage accessories

HSIB, black: as conductor insulation for plastic-insulated cables to 69kV, repair and connection of numerous insulating and cable materials, for sealing casting moulds and stuffing cable insulation.

Cable warning tape, yellow with black marking: used as an early warning device for excavation work. It should be placed approx. 40 cm above the supply cable, PE laminated film.

Properties

HSIB: good electric and physical properties guarantee long tool life, good dielectric properties, highly weather-resistant, extremely expandable, non-adhesive, welds quickly to form homogenous, cavity-free mass, easy to handle, easy to process, completely removable.

Cable warning tape: Good warning effect through more than 400% expansion, colour-fast, age and cold-resistant, expansion remains unchanged, permanently legible through crystal clear film coating over lettering.

HSIB high voltage insulation tape

Part no.	Type	Description	Thickness x Width mm x mm	Content	Unit	Net EUR/item at a purchase of		
						1	2 - 5	6 - 10
93128	HSIB	High-voltage insulating tape	0,5 x 19,0	10 m	1	o. r.	o. r.	o. r.
93129	HSIB	High-voltage insulating tape	0,75 x 19,0	10 m	1	o. r.	o. r.	o. r.

Warning tape

Part no.	Type	Description	Thickness x Width mm x mm	Content	Unit	Net EUR/item at a purchase of		
						1	2 - 5	6 - 10
93130	Warning tape	Caution: cable	0,15 x 40,0	250 m	1	o. r.	o. r.	o. r.
93131	Warning tape	Caution: high-voltage cable	0,15 x 40,0	250 m	1	o. r.	o. r.	o. r.
93132	Warning tape	Caution: telephone cable	0,15 x 40,0	250 m	1	o. r.	o. r.	o. r.
93133	Warning tape	Caution: street lighting	0,15 x 40,0	250 m	1	o. r.	o. r.	o. r.

Dimensions and specifications may be changed without prior notice.

o. r. = on request

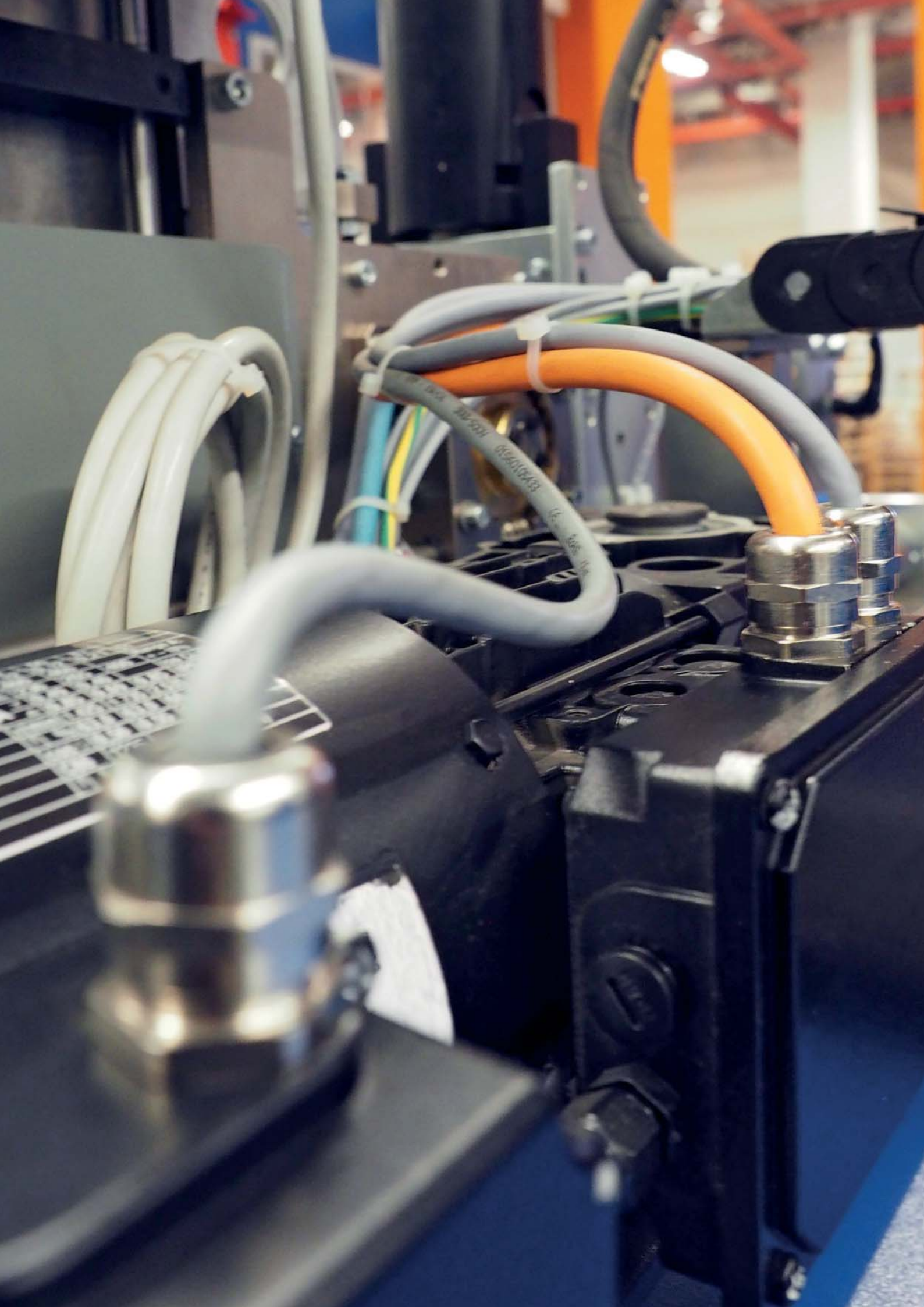

UV-STABILISED

TY-RAP®

TY-MX

TYZ

KLL

TWS



■ BUNDLING, BINDING, AND FASTENING

Series/Material	Application area	Item	Page
Plastic helix			
	Plastic helix	KW	344
Cable tie			
Series T&B	for standard applications	Cable tie TY-RAP®	345
	UV-stabilised	Cable tie TY-MX	346
	highly stabilised	Cable tie TYH	347
	highly resistant	Cable tie TYZ	348
	with additional fastening	TY-RAP® detectable cable tie	349
	with additional fastening	TY-RAP® special cable tie	350
	with marking area	TY-RAP® with label	351
Series Standard	for standard applications	Cable tie T	352
	Cable tie with steel tongue	Cable tie T-SK/SKU	353
	weather-resistant	Cable tie T WS	354
	detachable	Cable tie W	355
	robust application - stainless steel	Cable tie E	356
Hook and Loop cable tie			
	with punched hole	Hook and Loop cable tie KLL / KLÖ	357
Mounting base			
Series BS	as adhesive base	Mounting base BS	358
Series TC	for band fastening	Mounting base TC	359
	as mounting base	Mounting base TC	359
	as screw base	Mounting base TC	360
	with saddle	Mounting base TC	360
	as adhesive base	Mounting base TC	361

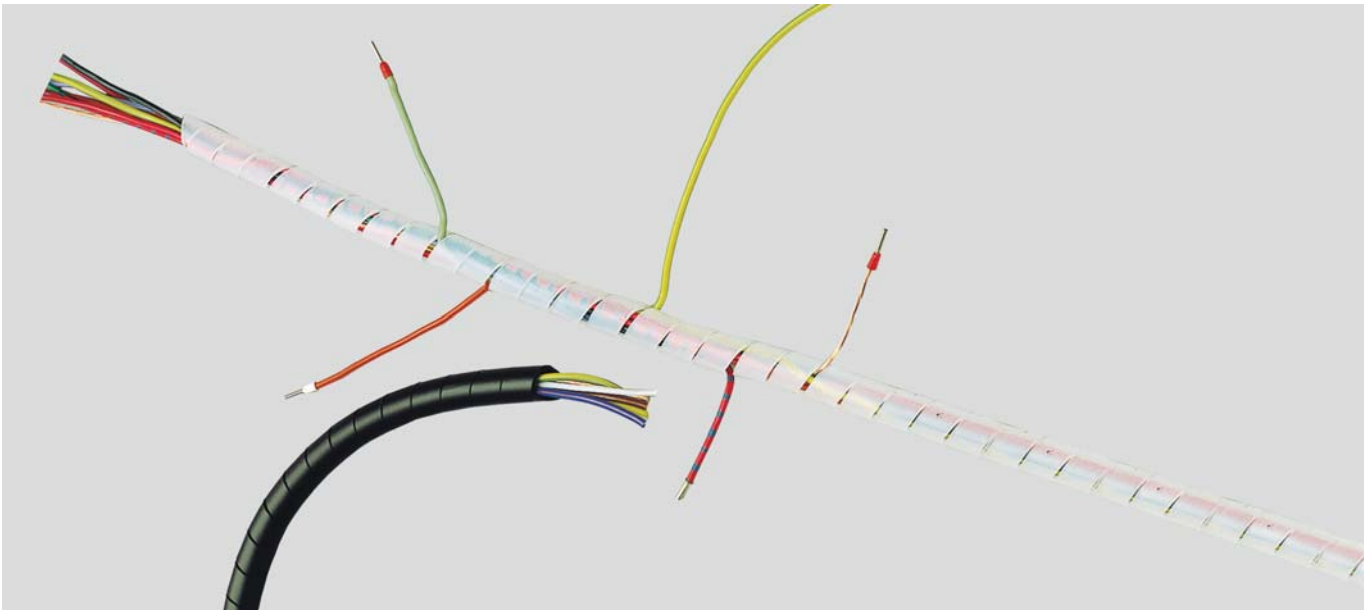

KW plastic helix

Plastic helix made of polyethylene. Protects wiring harnesses, wires and conductors. Bundles and binds single wires and provides mechanical protection for loosely installed or moving cables and wires.

Application

- Plant and machine construction
- Robotics
- Automation technology
- Vehicle construction and shipbuilding
- Railway technology
- Installation technology
- Control cabinet construction

Material

Polyethylene

- halogen-free

Note

Other materials or colours on request.

Technical data

Temperature range: -30°C up to +80°C

Part no.	Size	Colour	Bundle Ø mm	Per metres	Net EUR/100 metres at a purchase of		
					up to 100	101 - 500	501 - 1000
91000	6	transparent	5,0 - 20,0	25	o. r.	o. r.	o. r.
91001	6	black	5,0 - 20,0	25	o. r.	o. r.	o. r.
96659	6	yellow	5,0 - 20,0	25	o. r.	o. r.	o. r.
96891	6	orange	5,0 - 20,0	25	o. r.	o. r.	o. r.
91002	12	transparent	12,0 - 40,0	25	o. r.	o. r.	o. r.
91003	12	black	12,0 - 40,0	25	o. r.	o. r.	o. r.
96658	12	yellow	10,0 - 40,0	25	o. r.	o. r.	o. r.
97042	12	orange	10,0 - 40,0	25	o. r.	o. r.	o. r.
96300	22	transparent	20,0 - 150,0	25	o. r.	o. r.	o. r.
96299	22	black	20,0 - 150,0	25	o. r.	o. r.	o. r.

Dimensions and specifications may be changed without prior notice.

o. r. = on request

TY-RAP® Cable tie with steel lug lock

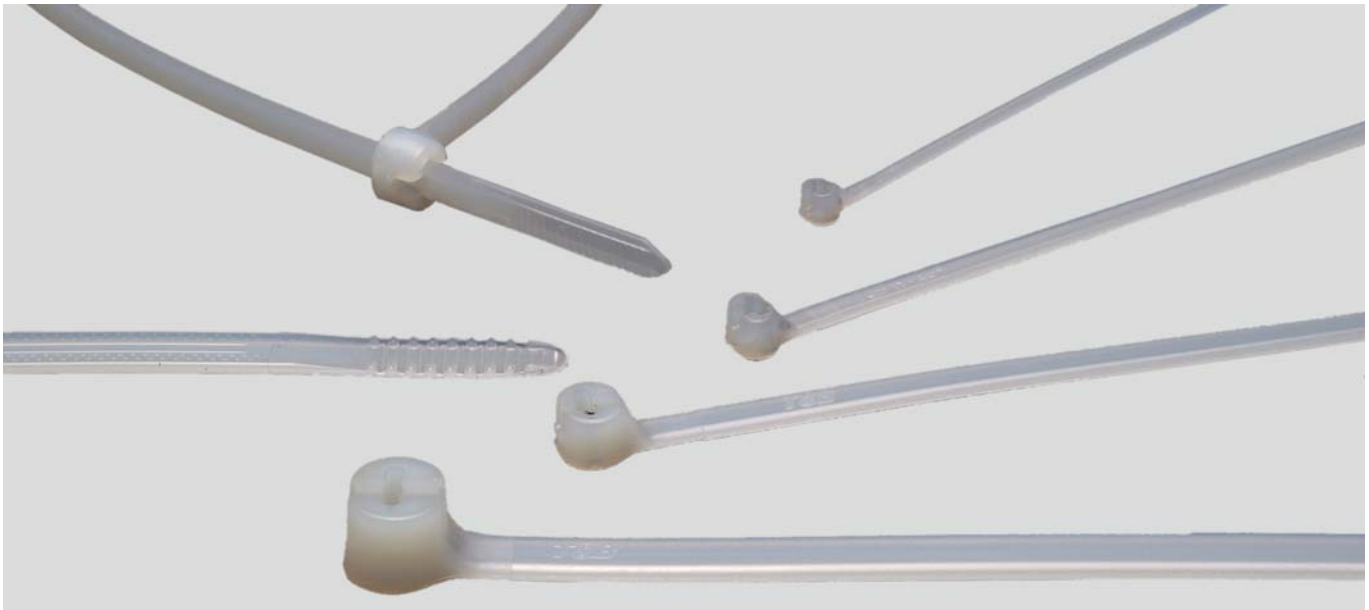

TY-RAP® transparent

Cable tie with steel lug lock made of corrosion-resistant, non-magnetic steel. This technology enables the cable tie to offer excellent binding properties even under most rigorous conditions such as heat, cold, humidity etc. It is impervious to vibrations and external influences.

Material

Polyamide 6.6

- halogen-free

Note

Brown, red, orange, yellow, green, purple or grey available on request.

Technical data

Temperature range: -60°C up to +85°C

Flammability acc. to UL 94: V2

Part no. transparent	Type	Length mm	Width mm	Bundle Ø mm	Capacity N	Unit	Net EUR/100 items at a purchase of		
							up to 1000	1001 - 5000	5001 - 10000
91051	TYB 23M	92,0	2,4	16,0	80,0	1000	o. r.	o. r.	o. r.
91055	TY 232M	203,0	2,4	50,0	80,0	1000	o. r.	o. r.	o. r.
91058	TY 234M	356,0	2,4	102,0	80,0	1000	o. r.	o. r.	o. r.
91061	TYB 24M	140,0	3,6	29,0	180,0	1000	o. r.	o. r.	o. r.
91064	TY 242M	204,0	3,6	50,0	180,0	1000	o. r.	o. r.	o. r.
91067	TY 26M	284,0	3,6	76,0	130,0	1000	o. r.	o. r.	o. r.
91070	TY 244M	368,0	3,6	103,0	130,0	1000	o. r.	o. r.	o. r.
91073	TYB 25M	186,0	4,8	45,0	220,0	1000	o. r.	o. r.	o. r.
91076	TY 253M	295,0	4,8	78,0	220,0	1000	o. r.	o. r.	o. r.
91079	TY 28M	361,0	4,8	102,0	220,0	1000	o. r.	o. r.	o. r.
91082	TY 272M	223,0	6,9	50,0	540,0	500	o. r.	o. r.	o. r.
91085	TY 27M	340,0	6,9	90,0	540,0	500	o. r.	o. r.	o. r.
91088	TY 29M	771,0	6,9	229,0	540,0	500	o. r.	o. r.	o. r.

Small package

Part no. transparent	Type	Length mm	Width mm	Bundle Ø mm	Capacity N	Unit	Net EUR/100 items at a purchase of		
							up to 1000	1001 - 5000	5001 - 10000
91050	TY 5-23M	92,0	2,4	16,0	80,0	100	o. r.	o. r.	o. r.
91054	TY 5-232M	203,0	2,4	50,0	80,0	100	o. r.	o. r.	o. r.
91057	TY 5-234M	356,0	2,4	102,0	80,0	100	o. r.	o. r.	o. r.
91060	TY 5-24M	140,0	3,6	29,0	180,0	100	o. r.	o. r.	o. r.
91063	TY 5-242M	204,0	3,6	50,0	180,0	100	o. r.	o. r.	o. r.
91066	TY 5-26M	284,0	3,6	76,0	130,0	100	o. r.	o. r.	o. r.
91069	TY 5-244M	368,0	3,6	103,0	130,0	100	o. r.	o. r.	o. r.
91072	TY 5-25M	186,0	4,8	45,0	220,0	100	o. r.	o. r.	o. r.
91075	TY 5-253M	295,0	4,8	78,0	220,0	100	o. r.	o. r.	o. r.
91078	TY 5-28M	361,0	4,8	102,0	220,0	100	o. r.	o. r.	o. r.
91081	TY 5-272M	223,0	6,9	50,0	540,0	50	o. r.	o. r.	o. r.
91084	TY 5-27M	340,0	6,9	90,0	540,0	50	o. r.	o. r.	o. r.
91087	TY 5-29M	771,0	6,9	229,0	540,0	50	o. r.	o. r.	o. r.

Dimensions and specifications may be changed without prior notice.

o. r. = on request

TY-MX Cable tie with steel lug lock



TY-RAP® (UV-stabilised)

Cable tie with steel lug lock made of corrosion-resistant, non-magnetic steel. This technology enables the cable tie to offer excellent binding properties even under the most rigorous conditions such as heat, cold, humidity etc. It is impervious to vibrations and external influences.

Material

Polyamide 6.6
UV-resistant

- halogen-free
- silicone-free

Note

Other colours and materials available on request.

Technical data

Temperature range: -60°C up to +105°C

Flammability acc. to UL 94: V2

UV-stabilised

Part no.	Type	Length mm	Width mm	Bundle Ø mm	Capacity N	Unit	Net EUR/100 items at a purchase of		
							up to 1000	1001 - 5000	5001 - 10000
91052	TYB 23MX	92,0	2,4	16,0	80,0	1000	o. r.	o. r.	o. r.
91056	TY 232MX	203,0	2,4	50,0	80,0	1000	o. r.	o. r.	o. r.
91059	TY 234MX	356,0	2,4	102,0	80,0	1000	o. r.	o. r.	o. r.
91062	TYB 24MX	140,0	3,6	29,0	180,0	1000	o. r.	o. r.	o. r.
91065	TY 242MX	204,0	3,6	50,0	180,0	1000	o. r.	o. r.	o. r.
91068	TY 26MX	284,0	3,6	76,0	130,0	1000	o. r.	o. r.	o. r.
91071	TY 244MX	368,0	3,6	103,0	130,0	1000	o. r.	o. r.	o. r.
91074	TYB 25MX	186,0	4,8	45,0	220,0	1000	o. r.	o. r.	o. r.
91077	TY 253MX	295,0	4,8	78,0	220,0	1000	o. r.	o. r.	o. r.
91080	TY 28MX	361,0	4,8	102,0	220,0	1000	o. r.	o. r.	o. r.
91083	TY 272MX	223,0	6,9	50,0	540,0	500	o. r.	o. r.	o. r.
91086	TY 27MX	340,0	6,9	90,0	540,0	500	o. r.	o. r.	o. r.
91089	TY 29MX	771,0	6,9	229,0	540,0	500	o. r.	o. r.	o. r.

UV-stabilised - small package

Part no.	Type	Length mm	Width mm	Bundle Ø mm	Capacity N	Unit	Net EUR/100 items at a purchase of		
							up to 1000	1001 - 5000	5001 - 10000
97310	TY 5-23MX	92,0	2,4	16,0	80,0	100	o. r.	o. r.	o. r.
97311	TY 5-232MX	203,0	2,4	50,0	80,0	100	o. r.	o. r.	o. r.
97312	TY 5-234MX	356,0	2,4	102,0	80,0	100	o. r.	o. r.	o. r.
97313	TYB 5-24MX	140,0	3,6	29,0	180,0	100	o. r.	o. r.	o. r.
97314	TY 5-242MX	204,0	3,6	50,0	180,0	100	o. r.	o. r.	o. r.
97436	TY 5-26MX	284,0	3,6	76,0	130,0	100	o. r.	o. r.	o. r.
97437	TY 5-244MX	368,0	3,6	103,0	130,0	100	o. r.	o. r.	o. r.
93694	TY 5-25MX	186,0	4,8	45,0	220,0	100	o. r.	o. r.	o. r.
93695	TY 5-253MX	295,0	4,8	78,0	220,0	100	o. r.	o. r.	o. r.
93696	TY 5-28MX	361,0	4,8	102,0	220,0	100	o. r.	o. r.	o. r.
93697	TY 5-272MX	223,0	6,9	50,0	540,0	50	o. r.	o. r.	o. r.
93698	TY 5-27MX	340,0	6,9	90,0	540,0	50	o. r.	o. r.	o. r.
93699	TY 5-29MX	771,0	6,9	229,0	540,0	50	o. r.	o. r.	o. r.

Dimensions and specifications may be changed without prior notice.

o. r. = on request

TYH Cable tie with steel lug lock

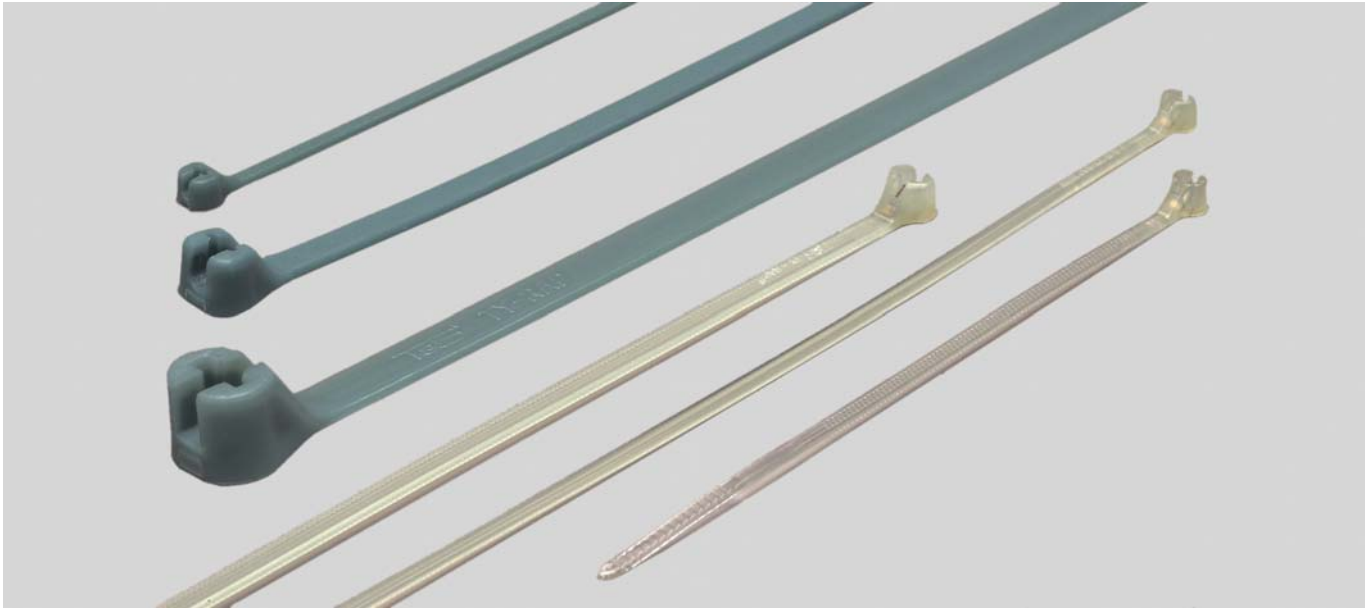

TY-RAP®

Cable tie with steel lug lock made of corrosion-resistant, non-magnetic steel. This technology enables the cable tie to offer excellent binding properties even under most rigorous conditions such as heat, cold, humidity etc. It is impervious to vibrations and external influences.

Material

H = Polyamide 6.6 (heat-stabilised)

- halogen-free
- silicone-free

Technical data

Temperature range: -60°C up to +105°C

Flammability acc. to UL 94: V2

Heat stabilised

Part no.	Type	Colour	Length mm	Width mm	Bundle Ø mm	Capacity N	Unit	Net EUR/100 items at a purchase of		
								up to 1000	1001 - 5000	5001 - 10000
97280	TYH 23M	transparent	92,0	2,4	16,0	80,0	1000	o. r.	o. r.	o. r.
96481	TYH 232M	transparent	203,0	2,4	50,0	80,0	1000	o. r.	o. r.	o. r.
96577	TYH 24M	transparent	140,0	3,6	29,0	130,0	1000	o. r.	o. r.	o. r.
98520	TYH 242M	transparent	208,0	3,6	50,0	130,0	1000	o. r.	o. r.	o. r.
97249	TYH 26M	transparent	284,0	3,6	76,0	130,0	1000	o. r.	o. r.	o. r.
97213	TYH 25M	transparent	186,0	4,8	45,0	220,0	1000	o. r.	o. r.	o. r.
98521	TYH 253M	transparent	290,0	4,8	78,0	220,0	1000	o. r.	o. r.	o. r.
96291	TYH 28M	transparent	360,0	4,8	102,0	220,0	1000	o. r.	o. r.	o. r.
98522	TYH 272M	transparent	222,0	7,6	50,0	540,0	500	o. r.	o. r.	o. r.
97154	TYH 27M	transparent	340,0	7,0	90,0	540,0	500	o. r.	o. r.	o. r.
97250	TYH 29M	transparent	771,0	6,9	229,0	530,0	500	o. r.	o. r.	o. r.

Dimensions and specifications may be changed without prior notice.

o. r. = on request

TYZ Cable tie with steel lug lock



TY-RAP®

Cable tie with steel lug lock made of corrosion-resistant, non-magnetic steel. This technology enables the tie to offer excellent binding properties even under the most rigorous conditions such as heat, cold, humidity etc. It is impervious to vibrations and external influences.

Material

ETFE Fluoropolymer
UV-resistant

- halogen-free
- silicone-free

Technical data

Temperature range: -60°C up to +170°C

Flammability acc. to UL 94: V0

Application

- Plant and machine construction
- Robotics
- Automation technology
- Vehicle construction and shipbuilding
- Railway technology
- Installation technology
- Control cabinet construction

High resistant

Part no.	Type	Colour	Length mm	Width mm	Bundle Ø mm	Capacity N	Unit	Net EUR/100 items at a purchase of		
								up to 1000	1001 - 5000	5001 - 10000
96909	TYZ 23M	aquamarine	92,0	2,4	16,0	80,0	1000	o. r.	o. r.	o. r.
96290	TYZ 25M	aquamarine	186,0	4,8	45,0	220,0	1000	o. r.	o. r.	o. r.
96724	TYZ 28M	aquamarine	360,0	4,8	102,0	220,0	500	o. r.	o. r.	o. r.
94800	TYZ 27M	aquamarine	340,0	7,0	90,0	540,0	100	o. r.	o. r.	o. r.

Dimensions and specifications may be changed without prior notice.

o. r. = on request

TY-RAP® Detectable cable ties



TY-RAP® Detectable cable ties

- Detectable by metal detectors set at minimum 1.5mm diameter ferrous sphere
- Detectable by X-Ray equipment
- Bright blue colour for an easy visual detection
- Help achieve the HACCP EU-Directive, compliant to the FDA regulation
- For liquid-processing applications

Material

- halogen-free

Note

- Available versions:
- PA 6.6
 - Polypropylene

Technical data

Temperature range: -40°C up to +85°C

Flammability acc. to UL 94: V2

PA 6.6

Part no. blue	Type	Length mm	Width mm	Bundle Ø mm	Capacity N	Unit	Net EUR/100 items at a purchase of		
							up to 1000	1001 - 5000	5001 - 10000
908524	TY523M-NDT	92,0	2,4	16,0	80,0	100	o. r.	o. r.	o. r.
908525	TY524M-NDT	140,0	3,6	29,0	180,0	100	o. r.	o. r.	o. r.
908526	TY525M-NDT	186,0	4,8	45,0	220,0	100	o. r.	o. r.	o. r.
908527	TY528M-NDT	360,0	4,8	102,0	220,0	100	o. r.	o. r.	o. r.
908528	TY527M-NDT	340,0	7,0	90,0	540,0	50	o. r.	o. r.	o. r.

Polypropylene

Part no. blue	Type	Length mm	Width mm	Bundle Ø mm	Capacity N	Unit	Net EUR/100 items at a purchase of		
							up to 1000	1001 - 5000	5001 - 10000
908529	TY523M-PDT	92,0	2,4	16,0	80,0	100	o. r.	o. r.	o. r.
908530	TY525M-PDT	186,0	4,8	45,0	130,0	100	o. r.	o. r.	o. r.
908531	TY528M-PDT	360,0	4,8	102,0	130,0	100	o. r.	o. r.	o. r.
908532	TY527M-PDT	340,0	7,0	90,0	270,0	50	o. r.	o. r.	o. r.

Dimensions and specifications may be changed without prior notice.

o. r. = on request

TY-RAP® special cable tie Cable tie with steel lug lock



TY-RAP® (special types)

Cable tie with steel lug lock made of corrosion-resistant, non-magnetic steel. This technology enables the cable tie to offer excellent binding properties even under most rigorous conditions such as heat, cold, humidity. It is impervious to vibrations and external influences.

Material

Polyamide 6.6

- halogen-free
- silicone-free

Technical data

Temperature range: -60°C up to +85°C

Flammability acc. to UL 94: V2

With assembly hole

Part no.	Type	Colour	Length mm	Width mm	Bundle Ø mm	Capacity N	Hole Ø mm	Field W x H	Unit	Net EUR/100 items at a purchase of		
										up to 1000	1001 - 5000	5001 - 10000
transparent												
91093	TY 33M	transparent	102,0	2,3	16,0	80	3	-	1000	o. r.	o. r.	o. r.
91094	TY 34M	transparent	151,0	3,5	29,0	180	4,4	-	1000	o. r.	o. r.	o. r.
91095	TY 635M	transparent	198,0	4,7	45,0	220	4	-	1000	o. r.	o. r.	o. r.
91096	TY 35M	transparent	199,0	4,7	45,0	220	5,1	-	1000	o. r.	o. r.	o. r.
91098	TY 37M	transparent	356,0	7,7	90,0	540	6,7	-	500	o. r.	o. r.	o. r.

With plug-in clip

Part no.	Type	Colour	Length mm	Width mm	Bundle Ø mm	Capacity N	Hole Ø mm	Field W x H	Unit	Net EUR/100 items at a purchase of		
										up to 1000	1001 - 5000	5001 - 10000
transparent												
91103	TY 38M	transparent	200,0	4,7	44,0	220	-	-	1000	o. r.	o. r.	o. r.

Dimensions and specifications may be changed without prior notice.

o. r. = on request

TY-RAP® with label Cable tie with steel lug lock



TY-RAP®

Cable tie with steel lug lock made of corrosion-resistant, non-magnetic steel. This technology enables the cable tie to offer excellent binding properties even under most rigorous conditions such as heat, cold, humidity. It is impervious to vibrations and external influences.

Material

Polyamide 6.6

- halogen-free
- silicone-free

Note

TY-RAP® (special types)

Technical data

Temperature range: -60°C up to +85°C

Flammability acc. to UL 94: V2

Marking area below the latch

Part no.	Type	Colour	Length mm	Width mm	Bundle Ø mm	Capacity N	Hole Ø mm	Field W x H	Unit	Net EUR/ 100 items at a purchase of		
										up to 1000	1001 - 5000	5001 - 10000
91108	TY 51M	transparent	92,0	2,4	16,0	80	-	25.4 x 7.9	500	o. r.	o. r.	o. r.
91109	TY 512M	transparent	210,0	2,4	51,0	80	-	25.4 x 7.9	1000	o. r.	o. r.	o. r.
91110	TY 48M	transparent	360,0	4,8	102,0	220	-	13.1 x 57.2	1000	o. r.	o. r.	o. r.
91111	TY 46M	transparent	184,0	4,8	45,0	220	-	13.1 x 27	1000	o. r.	o. r.	o. r.
91112	TY 46MD	transparent	184,0	4,8	45,0	2 x 220	-	29.7 x 27	500	o. r.	o. r.	o. r.
91113	TY 46MT	transparent	184,0	4,8	45,0	3 x 220	-	46 x 27	500	o. r.	o. r.	o. r.
91114	TY 46MF	transparent	184,0	4,8	45,0	4 x 220	-	63.1 x 27	250	o. r.	o. r.	o. r.

Marking area above the latch

Part no.	Type	Colour	Length mm	Width mm	Bundle Ø mm	Capacity N	Hole Ø mm	Field W x H	Unit	Net EUR/ 100 items at a purchase of		
										up to 1000	1001 - 5000	5001 - 10000
91106	TY 53M	transparent	102,0	2,4	16,0	80	-	20.6 x 9.3	500	o. r.	o. r.	o. r.
91107	TY 532M	transparent	212,0	2,4	51,0	80	-	20.6 x 9.3	1000	o. r.	o. r.	o. r.

Dimensions and specifications may be changed without prior notice.

o. r. = on request

T Cable tie



Cable tie

Cable ties with plastic lug for directionality and mounting cables and wires.

Application

- Plant and machine construction
- Robotics
- Automation technology
- Vehicle construction and shipbuilding
- Railway technology
- Installation technology
- Control cabinet construction

Material

Polyamide 6.6

- halogen-free
- silicone-free

Note

black: good UV-resistance

Technical data

Temperature range: -40°C up to +85°C

Flammability acc. to UL 94: V2

Part no. transparent	Part no. black	Type	Length mm	Width mm	Bundle Ø mm	Capacity N	Unit	Net EUR/100 items at a purchase of		
								up to 1000	1001 - 5000	5001 - 10000
90150	90140	T 2-20	100,0	2,5	24,0	110,0	100	o. r.	o. r.	o. r.
90151	90141	T 2-50	200,0	2,5	55,0	110,0	100	o. r.	o. r.	o. r.
90152	90142	T 3-35	140,0	3,5	36,0	200,0	100	o. r.	o. r.	o. r.
90153	90143	T 3-50	200,0	3,5	55,0	200,0	100	o. r.	o. r.	o. r.
90154	90144	T 3-75	280,0	3,5	80,0	200,0	100	o. r.	o. r.	o. r.
90157	90147	T 5-85	200,0	4,5	51,0	280,0	100	o. r.	o. r.	o. r.
90156	90146	T 5-75	280,0	4,5	76,0	280,0	100	o. r.	o. r.	o. r.
90158	90148	T 5-100	360,0	4,5	101,0	280,0	100	o. r.	o. r.	o. r.
90159	90149	T 8-100	360,0	7,5	101,0	650,0	100	o. r.	o. r.	o. r.
96491	96492	T 9-165	610,0	9,0	185,0	800,0	100	o. r.	o. r.	o. r.
97219	97223	T 9-230	762,0	9,0	236,0	800,0	100	o. r.	o. r.	o. r.

Dimensions and specifications may be changed without prior notice.

o. r. = on request

T-SK/SKU Cable tie with steel lug lock



T-SK

Cable tie with steel lug made of corrosion resistant, non-magnetic steel for bundling and mounting cables and lines etc.

Material

Polyamide 6.6

- halogen-free
- silicone-free
- self-extinguishing

Technical data

Temperature range: -40°C up to +85°C

Flammability acc. to UL 94: V2

Properties

- High requirements to flexibility and resistance, also at low temperatures and dry climate
- High tension due to extra wide steel lugs

T-SK

Part no. transparent	Type	Length mm	Width mm	Bundle Ø mm	Capacity N	Unit	Net EUR/100 items at a purchase of		
							up to 100	101 - 500	501 - 1000
907016	T-SK 2-24	100	2,5	24	180	1000	o. r.	o. r.	o. r.
907017	T-SK 2-55	200	2,5	55	180	1000	o. r.	o. r.	o. r.
907018	T-SK 3-36	140	3,5	36	280	1000	o. r.	o. r.	o. r.
907019	T-SK 3-55	200	3,5	55	280	1000	o. r.	o. r.	o. r.
907020	T-SK 3-80	280	3,5	80	280	1000	o. r.	o. r.	o. r.
907021	T-SK 4-51	186	4,5	51	400	1000	o. r.	o. r.	o. r.
907022	T-SK 4-76	290	4,5	76	400	1000	o. r.	o. r.	o. r.
907023	T-SK 4-101	360	4,5	101	400	1000	o. r.	o. r.	o. r.
907037	T-SK 7-95	340	7,0	95	700	500	o. r.	o. r.	o. r.

T-SKU UV-stabilized

Part no. black	Type	Length mm	Width mm	Bundle Ø mm	Capacity N	Unit	Net EUR/100 items at a purchase of		
							up to 100	101 - 500	501 - 1000
907024	T-SKU 2-24	100	2,5	24	180	1000	o. r.	o. r.	o. r.
907025	T-SKU 2-55	200	2,5	55	180	1000	o. r.	o. r.	o. r.
907026	T-SKU 3-36	140	3,5	36	280	1000	o. r.	o. r.	o. r.
907027	T-SKU 3-55	200	3,5	55	280	1000	o. r.	o. r.	o. r.
907028	T-SKU 3-80	280	3,5	80	280	1000	o. r.	o. r.	o. r.
907029	T-SKU 4-51	186	4,5	51	400	1000	o. r.	o. r.	o. r.
907030	T-SKU 4-76	290	4,5	76	400	1000	o. r.	o. r.	o. r.
907031	T-SKU 4-101	360	4,5	101	400	1000	o. r.	o. r.	o. r.
907038	T-SKU 7-95	340	7,0	95	700	500	o. r.	o. r.	o. r.

Dimensions and specifications may be changed without prior notice.

o. r. = on request

T-WS Cable tie

Weather-proof



Cable tie T-WS

Cable tie with plastic lug for bundling and mounting cables and wires.

Application

- Outdoor use

Material

Polyamide 6.6
UV-resistant

- halogen-free

Properties

- weather- stabilised

Technical data

Temperature range: -40°C up to +85°C
Temperature range temporary up to +105°C

Flammability acc. to UL 94: V2

Part no. black	Type	Length mm	Width mm	Bundle Ø mm	Capacity N	Unit	Net EUR/100 items at a purchase of		
							up to 1000	1001 - 5000	5001 - 10000
905525	T-WS 25/100 BK	100,0	2,5	22,0	80,0	100	o. r.	o. r.	o. r.
905527	T-WS 25/140 BK	145,0	2,5	35,0	80,0	100	o. r.	o. r.	o. r.
905526	T-WS 25/205 BK	205,0	2,5	55,0	80,0	100	o. r.	o. r.	o. r.
905528	T-WS 28/330 BK	330,0	2,8	95,0	110,0	100	o. r.	o. r.	o. r.
905529	T-WS 35/150 BK	150,0	3,5	35,0	135,0	100	o. r.	o. r.	o. r.
905530	T-WS 35/190 BK	190,0	3,5	50,0	135,0	100	o. r.	o. r.	o. r.
905531	T-WS 35/290 BK	285,0	3,5	80,0	135,0	100	o. r.	o. r.	o. r.
905532	T-WS 40/175 BK	175,0	4,0	40,0	180,0	100	o. r.	o. r.	o. r.
905535	T-WS 46/150 BK	150,0	4,6	35,0	225,0	100	o. r.	o. r.	o. r.
905533	T-WS 46/200 BK	210,0	4,7	55,0	355,0	100	o. r.	o. r.	o. r.
905536	T-WS 46/245 BK	245,0	4,6	65,0	225,0	100	o. r.	o. r.	o. r.
906682	T-WS 46/390 BK	390,0	4,7	110,0	355,0	100	o. r.	o. r.	o. r.
905537	T-WS 47/300 BK	300,0	4,7	85,0	355,0	100	o. r.	o. r.	o. r.
905542	T-WS 76/225 BK	225,0	7,6	55,0	535,0	100	o. r.	o. r.	o. r.
905539	T-WS 76/300 BK	300,0	7,6	80,0	535,0	100	o. r.	o. r.	o. r.
905543	T-WS 76/365 BK	365,0	7,6	100,0	670,0	100	o. r.	o. r.	o. r.
906683	T-WS 76/380 BK	387,0	7,6	100,0	535,0	100	o. r.	o. r.	o. r.
905541	T-WS 76/460 BK	460,0	7,6	130,0	535,0	100	o. r.	o. r.	o. r.
906684	T-WS 76/760 BK	760,0	7,6	225,0	535,0	100	o. r.	o. r.	o. r.
906685	T-WS 88/820 BK	820,0	8,8	245,0	780,0	100	o. r.	o. r.	o. r.
906686	T-WS 89/530 BK	525,0	8,9	150,0	780,0	100	o. r.	o. r.	o. r.
905546	T-WS 132/535 BK	535,0	13,2	150,0	1115,0	100	o. r.	o. r.	o. r.

Dimensions and specifications may be changed without prior notice.

o. r. = on request

W Cable tie

Unlockable



Cable tie

Detachable cable tie for temporary assembly. This cable tie can be opened by hand without using a tool.

Material

Polyamide 6.6

- halogen-free
- silicone-free

Technical data

Temperature range: -40°C up to +80°C

Flammability acc. to UL 94: V2

Part no. black	Length mm	Width mm	Bundle Ø mm	Capacity N	Unit	Net EUR/100 items at a purchase of		
						up to 1000	1001 - 5000	5001 - 10000
97633	120,0	7,6	26,0	220,0	100	o. r.	o. r.	o. r.
97634	200,0	7,6	50,0	220,0	100	o. r.	o. r.	o. r.
97635	300,0	7,6	80,0	220,0	100	o. r.	o. r.	o. r.
97636	370,0	7,6	102,0	220,0	100	o. r.	o. r.	o. r.

Dimensions and specifications may be changed without prior notice.

o. r. = on request

E Cable tie

Stainless steel



Cable tie

Cable tie made of stainless steel with ball lock for use in extreme conditions, such as high temperatures, aggressive environment, high tensile load.

Material

Stainless steel 1.4401 / AISI 316

Technical data

Temperature range: -80°C up to +538°C

Properties

Corrosion and radiation resistant, anti-magnetic, resistant to high temperatures and aggressive chemicals

Note

Approvals: GL, DNV, Lloyd's, UL

Part no.	Length mm	Width mm	Bundle Ø mm	Capacity N	Unit	Net EUR/100 items at a purchase of		
						up to 1000	1001 - 5000	5001 - 10000
90900	150,0	4,6	44,0	445,0	100	o. r.	o. r.	o. r.
90901	200,0	4,6	50,0	445,0	100	o. r.	o. r.	o. r.
90902	290,0	4,6	75,0	445,0	100	o. r.	o. r.	o. r.
90903	360,0	4,6	102,0	445,0	100	o. r.	o. r.	o. r.
90904	200,0	7,9	50,0	1112,0	100	o. r.	o. r.	o. r.
90905	290,0	7,9	75,0	1112,0	100	o. r.	o. r.	o. r.
90906	360,0	7,9	102,0	1112,0	100	o. r.	o. r.	o. r.
90907	520,0	7,9	152,0	1112,0	25	o. r.	o. r.	o. r.

Dimensions and specifications may be changed without prior notice.

o. r. = on request

KLL / KLÖ Hook and loop cable tie



Velcro tie

Particularly suited for sensitive cables and wires that are to be bundled or fastened without kinking or pinching. Velcro binders exert only low pressure on the wires and lie evenly and flush. Suitable for up to 10,000 actuations in reusable bundling applications.

Material

KLL - Polyamide sleeve / PE mushroom head tape / with punched hole

Note

KLL – pre-punched on rolls
KLÖ – Packed small in poly bags

Technical data

Temperature range: -40°C up to +85°C

KLL with punched hole

Part no.	Colour	Length mm	Width mm	Bundle Ø mm	Unit	Net EUR/100 items at a purchase of		
						up to 100	101 - 500	501 - 1000
93730	black	150,0	20,0	45,0	1000	o. r.	o. r.	o. r.
93731	black	200,0	20,0	60,0	750	o. r.	o. r.	o. r.
93732	black	330,0	20,0	100,0	450	o. r.	o. r.	o. r.

KLÖ with plastic eye

Part no.	Colour	Length mm	Width mm	Bundle Ø mm	Unit	Net EUR/100 items at a purchase of		
						up to 100	101 - 500	501 - 1000
93735	red-black	195,0	25,0	55,0	10	o. r.	o. r.	o. r.
93736	red-black	240,0	25,0	70,0	10	o. r.	o. r.	o. r.
93737	red-black	360,0	25,0	110,0	10	o. r.	o. r.	o. r.

Dimensions and specifications may be changed without prior notice.

o. r. = on request

BS Mounting base

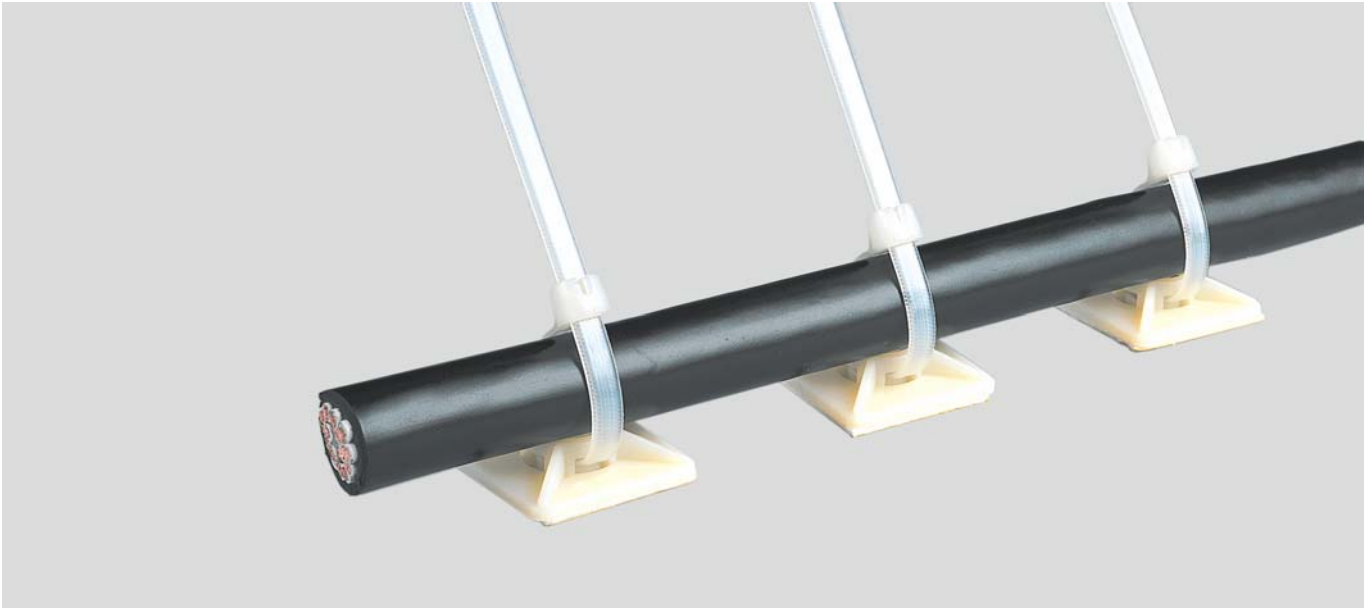

BS

BS mounting base self-adhesive and screwable for installing cables, wires, tubes and pipes. Simple handling by the combination with cable ties.

Application

- Plant and machine construction
- Robotics
- Automation technology
- Vehicle construction and shipbuilding
- Railway technology
- Installation technology
- Control cabinet construction

As adhesive base

Part no.	Type	Size l x w	Cable tie max. width mm	Drill hole mm	Unit	Net EUR/100 items at a purchase of		
						transparent	up to 1000	1001 - 5000
91090	BS 1	19,0 x 19,0	3,6	4,0	100	o. r.	o. r.	o. r.
91091	BS 2	28,0 x 28,0	5	5,0	100	o. r.	o. r.	o. r.
91092	BS 3	26,5 x 26,5	4,8	4,0	100	o. r.	o. r.	o. r.

Dimensions and specifications may be changed without prior notice.

o. r. = on request

Material

Polyamide 6.6

Colour: transparent

Note

Foamed self-adhesive foil adheres to smooth and grease-free surfaces and smooths out slightly uneven surfaces.

Technical data

Temperature range: -40°C up to +85°C

TC mounting base

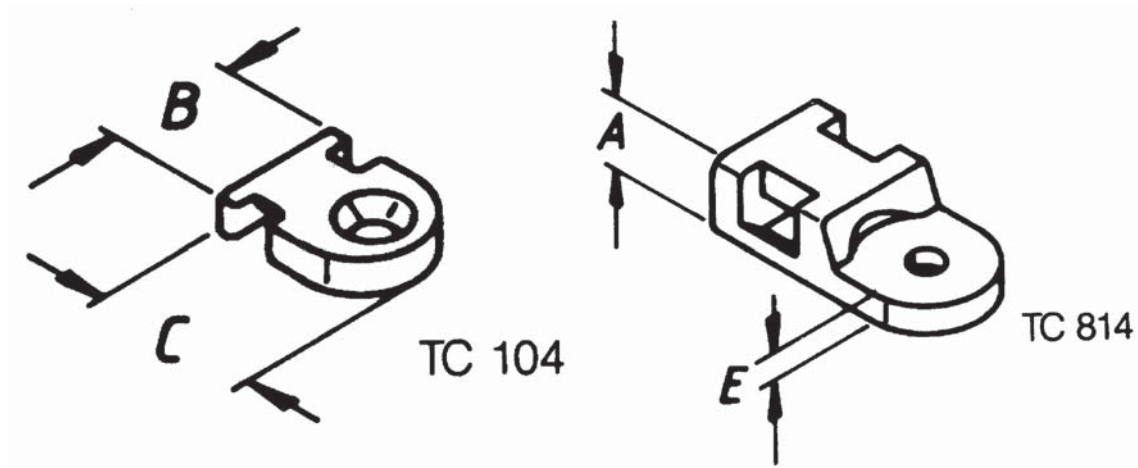

TC for band fastening

Small base for band fastening with countersunk screws, cylinder bolts or rivet assembly.

Material

Polyamide 6.6
Colour: transparent

Technical data

Temperature range: -40°C up to +85°C
Temperature range temporary up to +105°C

for band fastening

Part no.	Type	Fixing	A mm	B mm	C mm	D mm	E mm	F mm	Boring mm	Tie width max. mm	Unit	Net EUR/100 items at a purchase of		
transparent												up to 1000	1001 - 5000	5001 - 10000
91039	TC 102	Screw-in	3,2	12,7	19,1	-	-	-	4,4	4,8	100	o. r.	o. r.	o. r.
91040	TC 104	Screw-in	2,4	7,9	10,3	-	-	-	3,4	2,4	100	o. r.	o. r.	o. r.
91042	TC 112	Screw-in	4,8	9,5	19,1	-	2,0	-	4,4	4,8	100	o. r.	o. r.	o. r.
91043	TC 812	Screw-in	4,8	9,5	19,1	-	2,0	-	5,1	4,8	100	o. r.	o. r.	o. r.
93006	TC 814	Screw-in	4,8	9,5	19,1	-	2,0	-	3,3	4,8	100	o. r.	o. r.	o. r.

Dimensions and specifications may be changed without prior notice.

o. r. = on request

mounting base

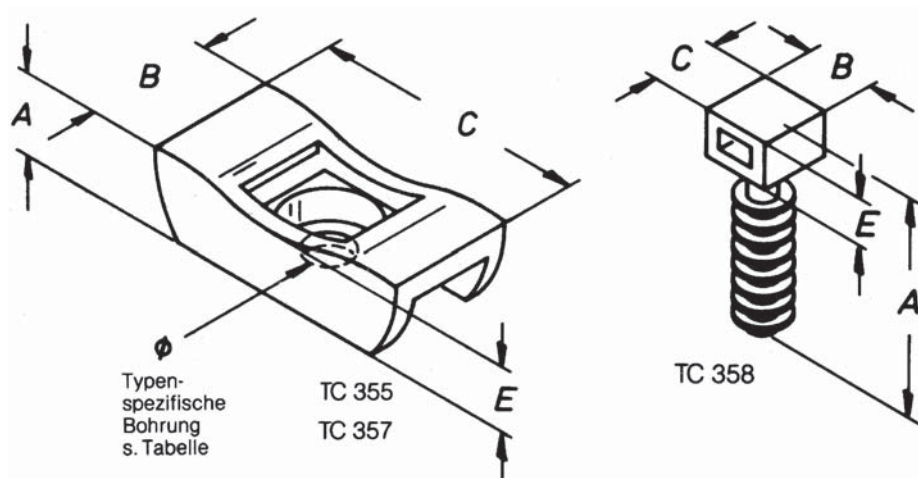

TC as mounting base

Mounting base for robust fastening of lines, pipes and tubes - outdoor applications included.

Material

Polyamide 6.6
Colour: black

Technical data

Temperature range: -40°C up to +85°C
Temperature range temporary up to +105°C

as mounting base

Part no.	Type	Fixing	A mm	B mm	C mm	D mm	E mm	F mm	Boring mm	Tie width max. mm	Unit	Net EUR/100 items at a purchase of		
black												up to 1000	1001 - 5000	5001 - 10000
91046	TC 5355	Screw-in	15,9	19,1	44,5	-	11,1	-	4,6	12,7	25	o. r.	o. r.	o. r.
91047	TC 5357	Screw-in	15,9	19,1	44,5	-	11,1	-	6,7	12,7	25	o. r.	o. r.	o. r.
91048	TC 5358	For fastening with anchors	31,8	9,9	9,9	-	7,1	-	6,4	4,8	100	o. r.	o. r.	o. r.

Dimensions and specifications may be changed without prior notice.

o. r. = on request

TC mounting base

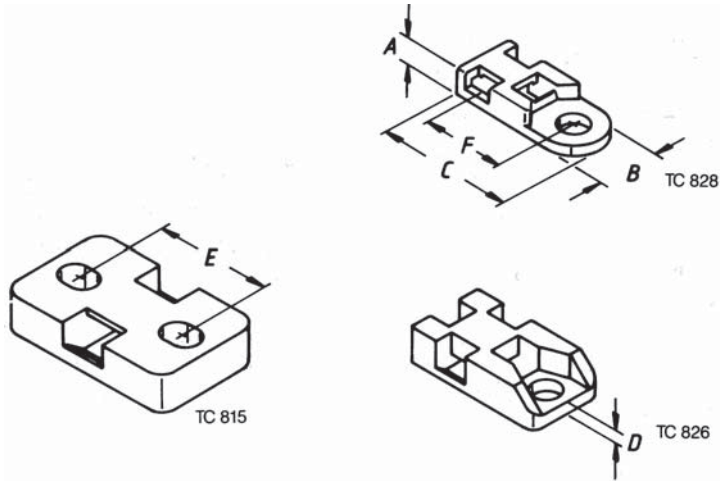

TC as screw base

Mounting base for bolting or riveting. Cable binder can be inserted from 4 sides.

Material

Polyamide 6.6
Colour: transparent

Technical data

Temperature range: -40°C up to +85°C
Temperature range temporary up to +105°C

as screwing socket

Part no.	Type	Fixing	A mm	B mm	C mm	D mm	E mm	F mm	Boring mm	Tie width max. mm	Unit	Net EUR/100 items at a purchase of		
												up to 1000	1001 - 5000	5001 - 10000
93007	TC 815	Screw-in	6,4	19,1	31,2	-	19,9	-	5,3	7,6	500	o. r.	o. r.	o. r.
93044	TC 826	Screw-in	5,7	12,7	23,8	-	-	-	4,4	4,8	1000	o. r.	o. r.	o. r.
93045	TC 828	Screw-in	3,8	10,1	22,5	-	-	-	4,3	4,8	1000	o. r.	o. r.	o. r.

Dimensions and specifications may be changed without prior notice.

o. r. = on request

mounting base

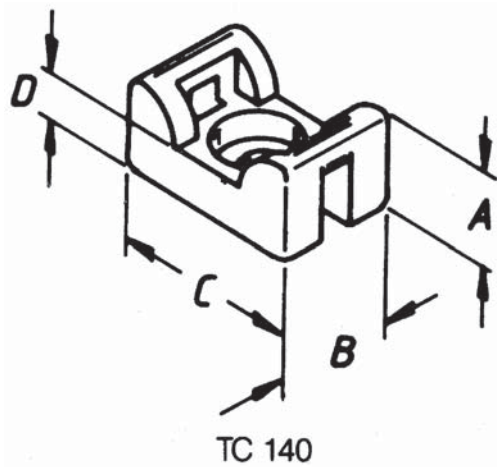

TC with saddle

Mounting base with support saddle.

Material

Polyamide 6.6
Colour: transparent

Technical data

Temperature range: -40°C up to +85°C
Temperature range temporary up to +105°C

with saddle

Part no.	Type	Fixing	A mm	B mm	C mm	D mm	E mm	F mm	Boring mm	Tie width max. mm	Unit	Net EUR/100 items at a purchase of		
												up to 1000	1001 - 5000	5001 - 10000
93005	TC 140	Screw-in	6,7	8,7	14,2	3,6	-	-	3,0	2,4	500	o. r.	o. r.	o. r.
93003	TC 141	Screw-in	7,5	11,1	17,0	4,0	-	-	3,8	4,8	500	o. r.	o. r.	o. r.
93004	TC 142	Screw-in	10,7	14,2	23,4	5,2	-	-	5,2	7,6	500	o. r.	o. r.	o. r.

Dimensions and specifications may be changed without prior notice.

o. r. = on request

TC mounting base

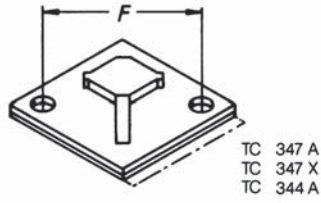

TC 347 A
TC 347 X
TC 344 A

TC as adhesive base

Adhesive base with foamed adhesive foil for smoothing out slightly uneven surfaces. Adheres to smooth, grease-free surfaces.

Material

Polyamide 6.6
Colour: transparent

Technical data

Temperature range: -40°C up to +85°C
Temperature range temporary up to +105°C

Note

* Part no. 91036 is black and UV-resistant, as well self-adhesive and screwable.

as adhesive base

Part no.	Type	Fixing	A mm	B mm	C mm	D mm	E mm	F mm	Boring mm	Tie width max. mm	Unit	Net EUR/100 items at a purchase of		
												up to 1000	1001 - 5000	5001 - 10000
93000	TC 344 A	Screw-in	4,9	19,1	19,1	-	-	-	-	3,6	1000	o. r.	o. r.	o. r.
93001	TC 347 A	Self-adhesive	8,5	29,0	29,0	-	-	-	-	7,6	1000	o. r.	o. r.	o. r.
91036	TC 347 X	Screw-in	7,8	28,6	28,6	-	-	-	-	7,6	1000	o. r.	o. r.	o. r.

Dimensions and specifications may be changed without prior notice.

o. r. = on request

SR APPLICATORS CABLE MARKER WMBW



■ CABLE MARKING SOLUTIONS

Series/Material	Item	Page
Marking rings		
	KROV	364
	KRGY	365
	KRGT	366
	KMP + KTP	367
	KME + KTE	368
SR	SR Applicators	369
	SR Marking rings	370
	Marking rings - Symbol Classification	371
Cable marker		
printed	Cable marker E WM	372
writeable	Cable marker WMBW	373
writeable	Cable marker TM	374

KROV Marking rings

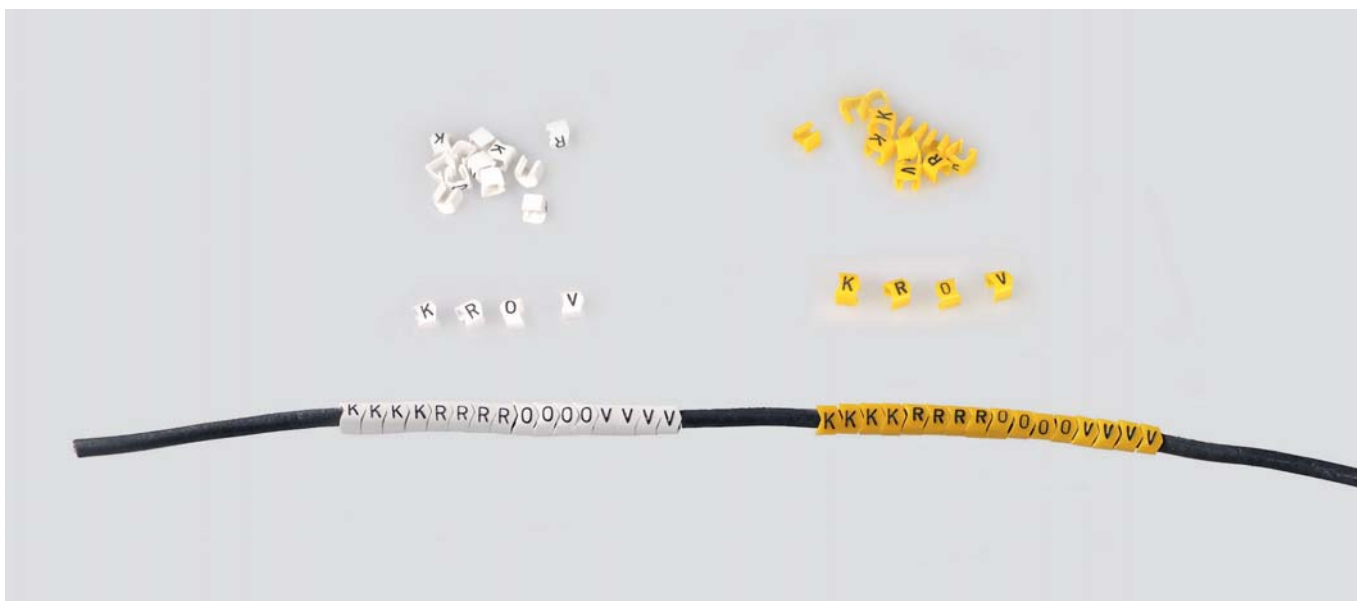

KROV

Marking rings, open
 Anti-rotation element
 Excellent readable
 Secure positioning through barbed hook
 Quick installation - let it easily snap-in
 Delivery colour white or yellow with black marking
 Pressure: hot stamped

Material

PVC
 • Cadmium-free
 • Silicone-free
 • UL94V0

Technical data

Temperature range: -30°C / +60°

Notes

Replace XX with the number of your required letter, figure or symbol. please see marking rings page 371. Packaging in polybag.

Item no:	Type	Colour with marking	Cable diameter from/to mm ²	Cable diameter from/to mm	Sleeve length mm	Height mm	Width mm	Height text mm	Unit	Net EUR/100 piece
9086xx	KROV 03	white/yellow with black	0,4 - 1,5	2,4 - 3	3	3,6	3,7	2,6	1.000 (5x200)	o.r.
9087xx	KROV 04	white/yellow with black	1,5 - 3	3,1 - 4	3	4,2	4,5	2,6	1.000 (5x200)	o.r.
9088xx	KROV 05	white/yellow with black	3 - 4	4 - 5	3	5,5	5,7	2,6	1.000 (5x200)	o.r.
9089xx	KROV 06	white/yellow with black	4 - 5	5 - 6.2	4	6.7	6.9	4	1,000 (5x200)	o.r.

Dimensions and specifications may change without prior notice.

KRGY Marking rings

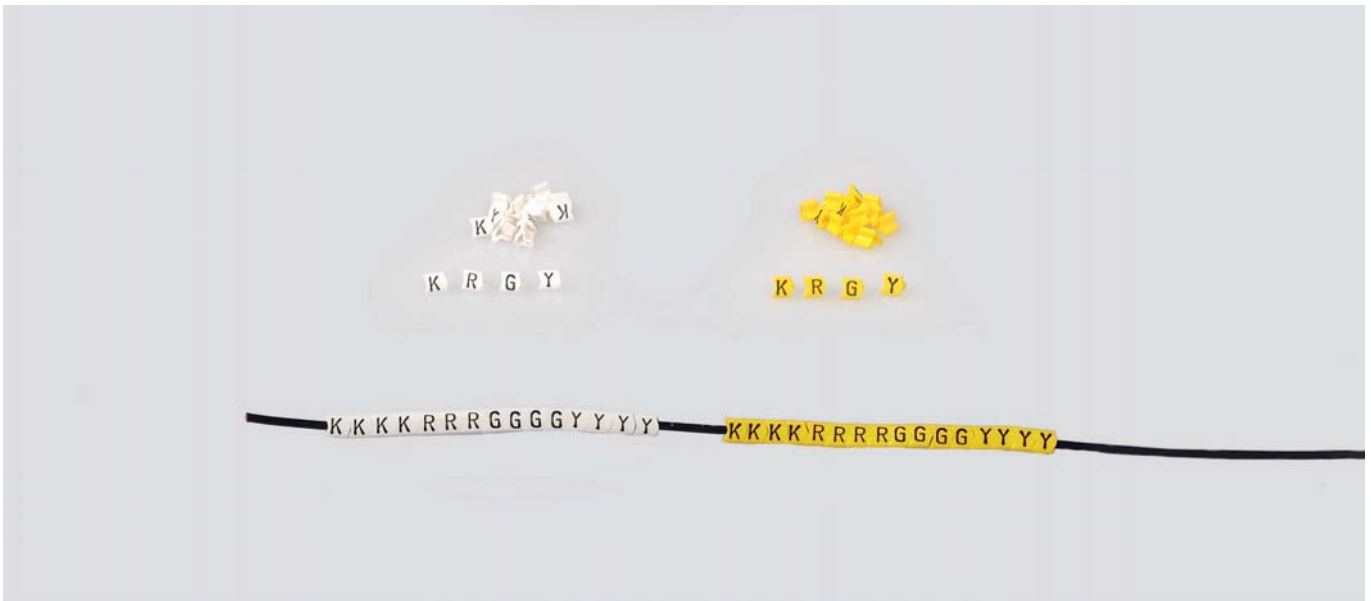

KRGY

Marking rings, closed version, for small cable diameters (Y-profile)

The flexible sleeve covers large diameter ranges and are quickly and easily installed.

Large surface Excellent readable

Delivery colour white or yellow with black marking

Pressure: hot stamped

Dimensions: Height 3,3 mm,

Width 3,5 mm, Height Text 2,6 mm

Material

PVC

- Cadmium-free
- Silicone-free
- UL94V0

Notes

Replace XX with the number of your required letter, figure or symbol. please see marking rings page 371. Packaging in polybag.

Technical data

Temperature range: -30°C / +60°

Item no:	Type	Colour with marking	Cable diameter from/to mm ²	Cable diameter from/to mm	Sleeve length mm	Height mm	Width mm	Height text mm	Unit	Net EUR/100 piece
9090xx	KRGY 02	white/yellow with black	0,2 - 0,7	1,0 bis 2,0	3	3,3	3,5	2,6	1.000	(5x200) o.r.

Dimensions and specifications may change without prior notice.

KRGT Marking rings



KRGT

Marking rings, closed
 Anti-rotation protection (Twist)
 Delivery colour white or yellow with black marking
 Pressure: hot stamped
 Excellent readable

Material

PVC
 • Cadmium-free
 • Silicone-free
 • UL94V0

Technical data

Temperature range: -30°C / +60°

Notes

Replace XX with the number of your required letter, figure or symbol. please see marking rings page 371. Packaging in polybag.

Item no:	Type	Colour with marking	Cable diameter from/ to mm ²	Cable diameter from/ to mm	Sleeve length mm	Unit	Net EUR/ 100 piece
9091xx	KRGT 03	white/yellow with black	0,2 - 1,5	1,3 - 3	3	1.000 (5x200)	o.r.
9092xx	KRGT 05	white/yellow with black	1,5 - 4	2,5 - 5	3	1.000 (5x200)	o.r.
9093xx	KRGT 10	white/yellow with black	2,5 - 16	4 - 10	4	500 (5x100)	o.r.
9094xx	KRGT 16	white/yellow with black	16 - 70	8 - 16	6	100 (5x20)	o.r.

Dimensions and specifications may change without prior notice.

KMP Cable marker + KTP Carrier strip

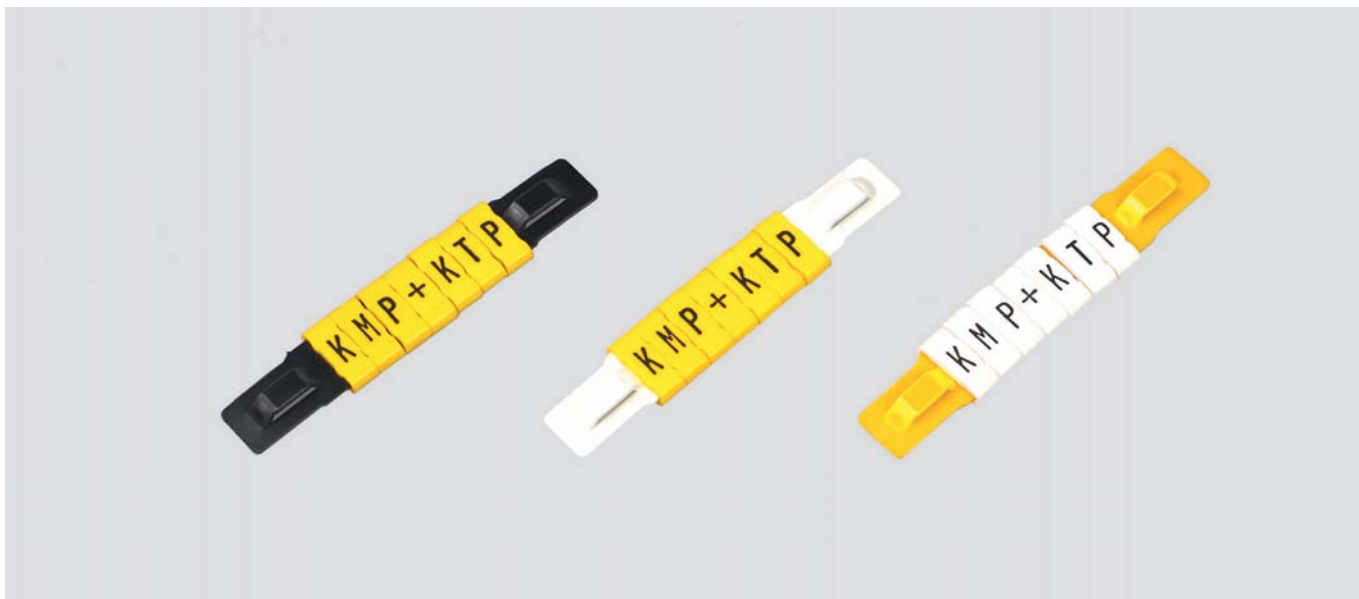

KMP/KTP

One size for all diameters
 Easy installation: Just slide KMP on KTP1 or on KTP2. Fix them with cable ties.
 closed version with anti-rotation protection
 Excellent readable
 Delivery colour white or yellow with black marking
 Pressure: hot stamped

Material

KMP: PVC
 • Cadmium-free
 • Silicone-free
 • UL94V0
 KTP: PA66

Technical data

Temperature range: -30°C / +60°

Notes

Replace XX with the number of your required letter, figure or symbol. please see marking rings page 371. Packaging in polybag (cable marking). Suitable product: Cable tie series T

Cable marker KMP

Item no:	Type	Length in mm	Height in mm	Unit	Net EUR/100 piece
9095xx	KMP 4	4	10	500 (5x100)	o.r.

Carrier strip KTP1 from PA66, black

Item no:	Type	Length in mm	max. number of marker	Unit	Net EUR/100 piece
909600	KTP1/60	60	8	100	o.r.
909601	KTP1/82	82	13	100	o.r.

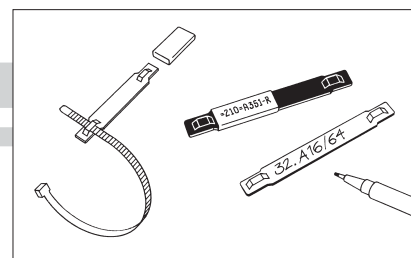

Carrier strip KTP2 from PA66, black

Item no:	Type	Length in mm	max. number of marker	Unit	Net EUR/100 piece
909602	KTP2/70	70	10	100	o.r.
909603	KTP2/100	100	20	100	o.r.

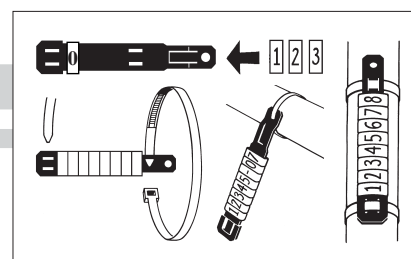

Dimensions and specifications may change without prior notice.

KME Cable marker + KTE Carrier strip



KME/KTE

Cable marker for extreme conditions
Easy mounting with stainless steel-
cable ties
Symbol combinations can be created
by assemble the individual components

Pressure: stamped (embossed)

Material

Stainless steel

Technical data

Not flammable

Notes

Replace XX with the number of your
required letter, figure or symbol. please
see marking rings page 371.

Suitable product: Cable tie series E item
no. 90900 to 90907.

Dimensions

Stainless steel marker KME

Item no:	Type	Length in mm	Height in mm	Unit	Net EUR/100 piece
9097xx	KME 55	5,5	10,9	50	o.r.

Carrier strip KTE (slotted for stainless steel cable ties)

Item no:	Type	Length in mm	Height in mm	Unit	Net EUR/100 piece
909801	KTE 47	47	6	50	o.r.
909802	KTE 65	65	9	50	o.r.
909803	KTE 87	87	13	50	o.r.
909804	KTE 107	107	17	50	o.r.
909967	KTE 128	128	20	50	o.r.

Dimensions and specifications may change
without prior notice.

SR Applicator

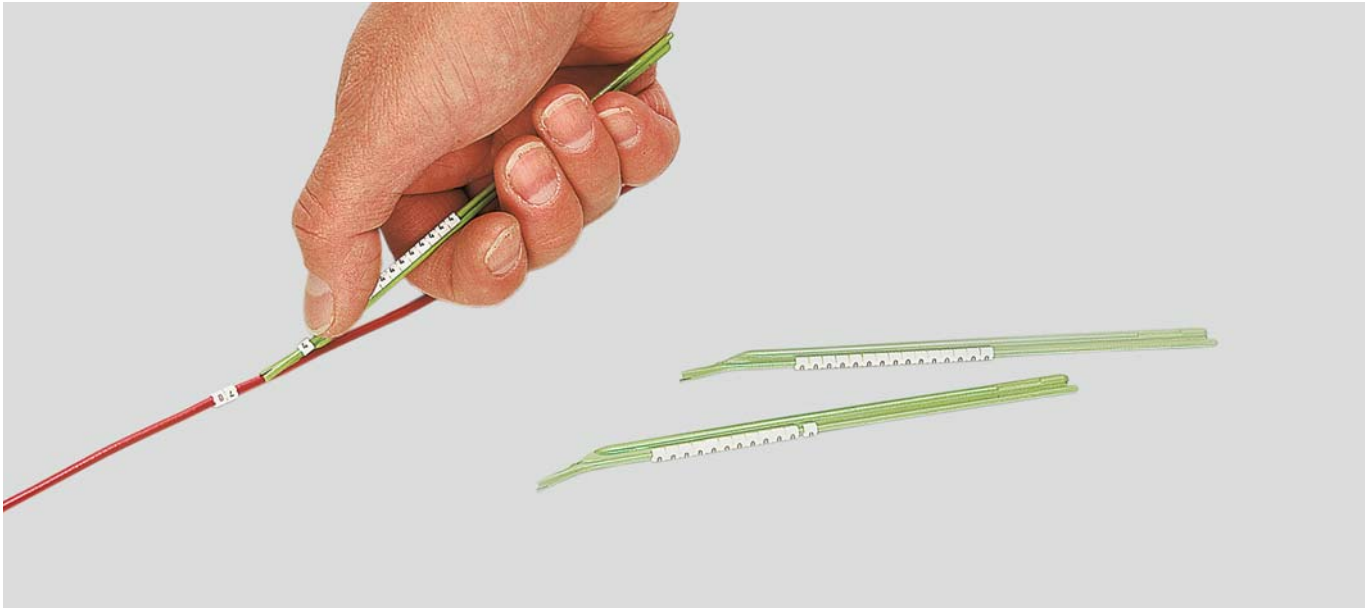

SR applicator

Simple handling afforded by marking rods characterise these marking rings. The nozzle-shaped marking rod is forced onto the cable and the snap-on sleeve pushed with the thumb. The marker sits tight on the cable without slip.

Material

Copolymer

- halogen-free

Technical data

Temperature range: -40°C up to +105°C

Part no.	Colour with inscription	Type	Cross section from - to mm ²	Cable Ø from - to mm	Stick colour	Unit	Net EUR/ 100 unit at a purchase of		
							1	2 - 5	6 - 10
95697	-	Applicator for SR 15	10 - 16	5,8 - 8,5	orange	5	o. r.	o. r.	o. r.
95797	-	Applicator for SR 17	16 - 25	8,5 - 11,5	orange	5	o. r.	o. r.	o. r.
99821	-	Applicator for SR 21	25 - 70	11,5 - 15,5	grey	2	o. r.	o. r.	o. r.
99822	-	Applicator for SR 24	70 - 100	15 - 19	grey	2	o. r.	o. r.	o. r.

Dimensions and specifications may be changed without prior notice.

o. r. = on request

SR Marking rings

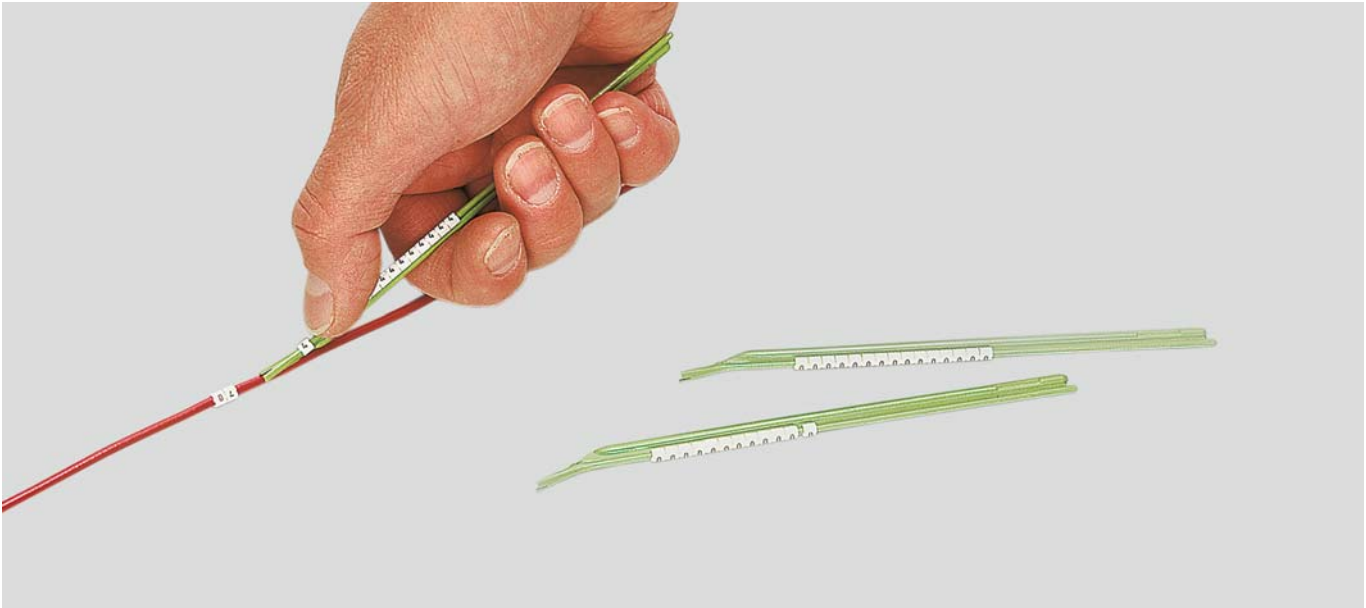

SR

Simple handling afforded by applicator characterise these marking rings. The nozzle-shaped applicator is forced onto the cable and the snap-on sleeve pushed with the thumb. The marker sits tight on the cable without slip. Available in white or yellow with black marking.

Application

1.0 mm to 19.0 mm
0.10 mm² - 100 mm²

Material

Copolymer

- halogen-free

Properties

Halogen-free, resistant to oils, cleaning agents, fuels and alkalis.

Note

Code:

Replace the XX by the number of your required letter, figure or symbol.

1 unit = 10 rods with each 30 rings.

Product 956xx up to 959xx without rod. The rod can be ordered separately.

Technical data

Temperature range: -40°C up to +105°C

Part no.	Colour with inscription	Type	Cross section from - to mm ²	Cable Ø from - to mm	Stick colour	Unit	Net EUR/100 unit at a purchase of		
							1	2 - 5	6 - 10
950xx	white/yellow with black	SR 01	0,1 - 0,5	1 - 1,4	brown	300	o. r.	o. r.	o. r.
951xx	white/yellow with black	SR 02	0,5 - 0,7	1,4 - 1,8	grey	300	o. r.	o. r.	o. r.
952xx	white/yellow with black	SR 03	0,8 - 1	1,9 - 2,6	green	300	o. r.	o. r.	o. r.
953xx	white/yellow with black	SR 06	1,5 - 3,4	2,6 - 3,5	red	300	o. r.	o. r.	o. r.
954xx	white/yellow with black	SR 09	2,5 - 6	3,3 - 4,5	blue	300	o. r.	o. r.	o. r.
955xx	white/yellow with black	SR 12	6 - 10	4,5 - 6	yellow	300	o. r.	o. r.	o. r.
956xx	white/yellow with black	SR 15	10 - 16	5,8 - 8,5	-	50	o. r.	o. r.	o. r.
957xx	white/yellow with black	SR 17	16 - 25	8,5 - 11,5	-	50	o. r.	o. r.	o. r.
958xx	white/yellow with black	SR 21	25 - 70	11 - 15,5	-	50	o. r.	o. r.	o. r.
959xx	white/yellow with black	SR 24	70 - 100	15 - 19	-	50	o. r.	o. r.	o. r.

Dimensions and specifications may be changed without prior notice.

o. r. = on request

MARKING RINGS

How to find the correct product code.

Replace XX with the number of your required letter, figure or symbol.

Basic colour: white

z. B.

A	=	...00
B	=	...01
C	=	...02
D	=	...03
E	=	...04
F	=	...05
G	=	...06
H	=	...07
I	=	...08
J	=	...09
K	=	...10
L	=	...11
M	=	...12
N	=	...13
O	=	...14
P	=	...15
Q	=	...16
R	=	...17
S	=	...18
T	=	...19
U	=	...20
V	=	...21
W	=	...22
X	=	...23
Y	=	...24
Z	=	...25
0	=	...60
1	=	...61
2	=	...62
3	=	...63
4	=	...64
5	=	...65
6	=	...66
7	=	...67
8	=	...68
9	=	...69

+ (plus)	=	...80
- (minus)	=	...81
• (spot)	=	...82
/ (diagonal slash)	=	...83
~ (alternating current)	=	...84
↓ (Earthing)	=	...85
neutral	=	...86

Basic colour: yellow

A	=	...30
B	=	...31
C	=	...32
D	=	...33
E	=	...34
F	=	...35
G	=	...36
H	=	...37
I	=	...38
J	=	...39
K	=	...40
L	=	...41
M	=	...42
N	=	...43
O	=	...44
P	=	...45
Q	=	...46
R	=	...47
S	=	...48
T	=	...49
U	=	...50
V	=	...51
W	=	...52
X	=	...53
Y	=	...54
Z	=	...55
0	=	...70
1	=	...71
2	=	...72
3	=	...73
4	=	...74
5	=	...75
6	=	...76
7	=	...77
8	=	...78
9	=	...79

+ (plus)	=	...90
- (minus)	=	...91
• (spot)	=	...92
/ (diagonal slash)	=	...93
~ (alternating current)	=	...94
↓ (Earthing)	=	...95
neutral	=	...96

KME stainless steel marker

A	=	...00
B	=	...01
C	=	...02
D	=	...03
E	=	...04
F	=	...05
G	=	...06
H	=	...07
I	=	...08
J	=	...09
K	=	...10
L	=	...11
M	=	...12
N	=	...13
O	=	...14
P	=	...15
Q	=	...16
R	=	...17
S	=	...18
T	=	...19
U	=	...20
V	=	...21
W	=	...22
X	=	...23
Y	=	...24
Z	=	...25
0	=	...60
1	=	...61
2	=	...62
3	=	...63
4	=	...64
5	=	...65
6	=	...66
7	=	...67
8	=	...68
9	=	...69

+ (plus)	=	...80
- (minus)	=	...81
• (spot)	=	...82
/ (diagonal slash)	=	...83
~ (alternating current)	=	...84
↓ (Earthing)	=	...85
neutral	=	...86

Example: Item number 95435 indicates ring type SR 09, letter „F“ in yellow.

E WM Cable marker



E WM

Self-adhesive cable marker in practical pocket book size.

10 side marker on siliconised carrier cards. Installation applications, for repair and maintenance.

Book dimension: 15 x 8 cm

Marker: 5 x 31 mm

Perforated individual characters, 5 x 5 mm

Material

Fibre tape

self-adhesive

Covering: carton

Properties

Permanently self-adhesive, insensitive to moisture and oils.

Technical data

Temperature range: -35°C up to +95°C

Cable marker

Part no.	Type	Book content	Marker	Unit	Net EUR/ 100 items at a purchase of		
					1	2 - 5	6 - 10
91148	E WM 0-9	40	Marker: 0 to 9	1	o. r.	o. r.	o. r.
91149	E WM 0-45	10	Marker: 0 to 45	1	o. r.	o. r.	o. r.
91150	E WM 46-90	10	Marker: 46 to 90	1	o. r.	o. r.	o. r.
91151	E WM A-Z	10	Marker: A to Z, +, -, ., 0 to 15	1	o. r.	o. r.	o. r.
91152	E WM 123	150	Marker: 1, 2, 3	1	o. r.	o. r.	o. r.
91153	E WM ABC	150	Marker: A, B, C	1	o. r.	o. r.	o. r.
91154	E WM ABC	10	Marker: 1 to 33, A, B, C, +, -, ., ; and for each 20 markers: T1, T2, T3	1	o. r.	o. r.	o. r.
91155	E WM A-90	4	Marker: 0 to 90, and for each 2 markers: A - Z, +, -, 0 to 15	1	o. r.	o. r.	o. r.

Dimensions and specifications may be changed without prior notice.

o. r. = on request

WMBW Cable marker



WMBW

Self-adhesive, writable cable marker in practical pocket book size.
10 side marker on siliconised carrier cards.
Installation applications, for repair and maintenance.
Book dimension: 15 x 8 cm

Material

Vinyl strips
self-adhesive
Covering: carton

Technical data

Temperature range: -30°C up to +70°C

WMBW

Part no.	Type	Book content	Size mm	Description field mm	Unit	Net EUR/100 items at a purchase of		
						1	2 - 5	6 - 10
91158	WMBW 3	30	25,0 x 124,0	25,0 x 25,0	1	o. r.	o. r.	o. r.
91159	WMBW 5	50	25,0 x 70,0	19,0 x 25,0	1	o. r.	o. r.	o. r.
91160	WMBW 12	200	13,0 x 32,0	13,0 x 16,0	1	o. r.	o. r.	o. r.
91161	WMBW 14	400	6,0 x 32,0	6,0 x 16,0	1	o. r.	o. r.	o. r.
91162	WMBW 34	140	19,0 x 32,0	16,0 x 19,0	1	o. r.	o. r.	o. r.

Dimensions and specifications may be changed without prior notice.

o. r. = on request



TM

Self-adhesive, writable cable marker in practical pocket book size.
10 side marker on siliconised carrier cards.
Installation applications, for repair and maintenance.
Book dimension: 15 x 8 cm

Material

PVC
self-adhesive
self-extinguishing
UV-resistant
oil-resistant

Adhesive: acrylate
Covering: carton

Properties

Resistant to:

- Water
- Alcohol
- Oils
- Greases
- Fuels
- Aliphatic solvents
- Weak acids
- Salts
- Alkalis

Technical data

Temperature range: -40°C up to +80°C
Temperature range temporary up to +120°C

TM

Part no.	Type	Book content	Size mm	Description field mm	Unit	Net EUR/100 items at a purchase of		
						1	2 - 5	6 - 10
91146	TM 50	90	15,0 x 50,0	15,0 x 25,0	1	o. r.	o. r.	o. r.
91180	TM 75	60	25,0 x 75,0	25,0 x 25,0	1	o. r.	o. r.	o. r.
91181	TM 150	30	25,0 x 150,0	25,0 x 25,0	1	o. r.	o. r.	o. r.
91147	TM 230	30	25,0 x 230,0	25,0 x 25,0	1	o. r.	o. r.	o. r.

Dimensions and specifications may be changed without prior notice.

o. r. = on request

HELUTEC®

ALWAYS GOOD CONNECTED WITH INDUSTRY CONNECTORS

HELUTEC® is the high-end product program of signal and power connectors from HELUKABEL®.
Signal connectors and power connectors for industrial applications.

Our Online service:

www.onlinekonfigurator.biz

Check out our **Online Connector Configurator**, where you can select your HELUTEC®-connector step by step



**HELUTEC® completely
pre-assembled**

Call us - We would be pleased to help you.
For further information, please order our detailed
HELUTEC® technical information.

Or visit our website at:

helukabel.com and helutec.com

PV-cable coupler and MC4 Coupling connector

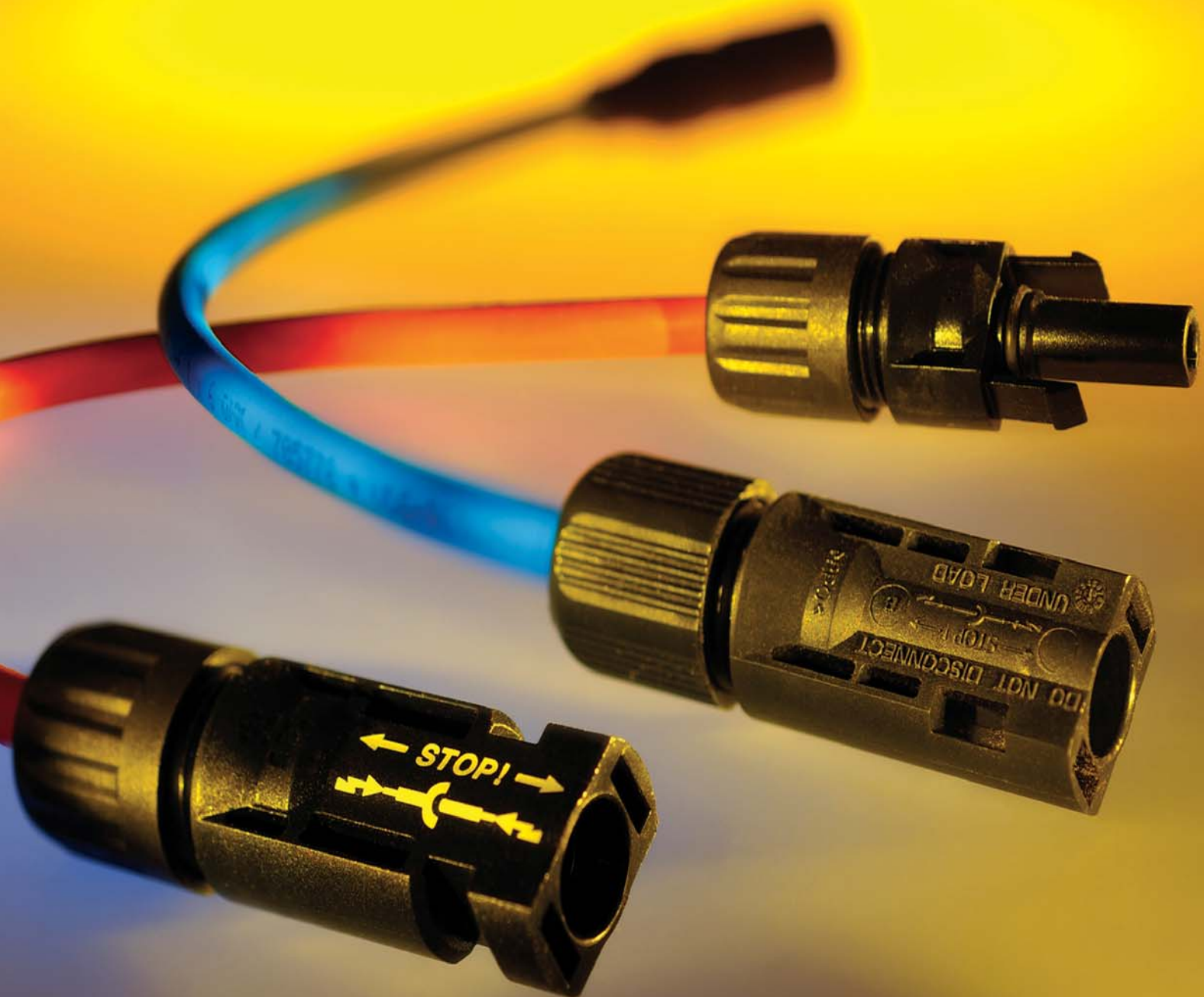

PV-male and female cable coupler MC4



PV- male and female cable coupler MC4

With Snap-in lock

Material

Polyamide
Contact: Cu, tinned, rotated

Technical data

Protection classification: IP 67
Safety class: II
Temperature range: -40°C up to +90°C
Rated voltage: 1000 V (IEC)
Rated current: 22A (2,5 mm²), 30A (4 mm², 6 mm²)
Contact resistance of plug connectors:
0.35 mOhm

MC4 male cable coupler

Part no.	Designation	Cross section mm ²	Cable Ø mm	Unit	Net EUR/100 items at a purchase of		
					up to 100	101 - 500	501 - 1000
905206	PV-male cable coupler MC4	2,5	3 - 6	50	o. r.	o. r.	o. r.
905208	PV-male cable coupler MC4	2,5	5,5 - 9	50	o. r.	o. r.	o. r.
905210	PV-male cable coupler MC4	4 - 6	3 - 6	50	o. r.	o. r.	o. r.
904963	PV-male cable coupler MC4	4 - 6	5,5 - 9	50	o. r.	o. r.	o. r.
905863	PV-male cable coupler MC4	10	5,5 - 9	50	o. r.	o. r.	o. r.

MC4 female cable coupler

Part no.	Designation	Cross section mm ²	Cable Ø mm	Unit	Net EUR/100 items at a purchase of		
					up to 100	101 - 500	501 - 1000
905207	PV-female cable coupler MC4	2,5	3 - 6	50	o. r.	o. r.	o. r.
905209	PV-female cable coupler MC4	2,5	5,5 - 9	50	o. r.	o. r.	o. r.
905211	PV-female cable coupler MC4	4 - 6	3 - 6	50	o. r.	o. r.	o. r.
904964	PV-female cable coupler MC4	4 - 6	5,5 - 9	50	o. r.	o. r.	o. r.
905864	PV-female cable coupler MC4	10	5,5 - 9	50	o. r.	o. r.	o. r.

Dimensions and specifications may be changed without prior notice.

o. r. = on request

ADI-K

ESD-ADI

COMPRESSION JOINTS PV-CMÖ

SHIELD-KON[®] RSK

TUBULAR CABLE LUG N

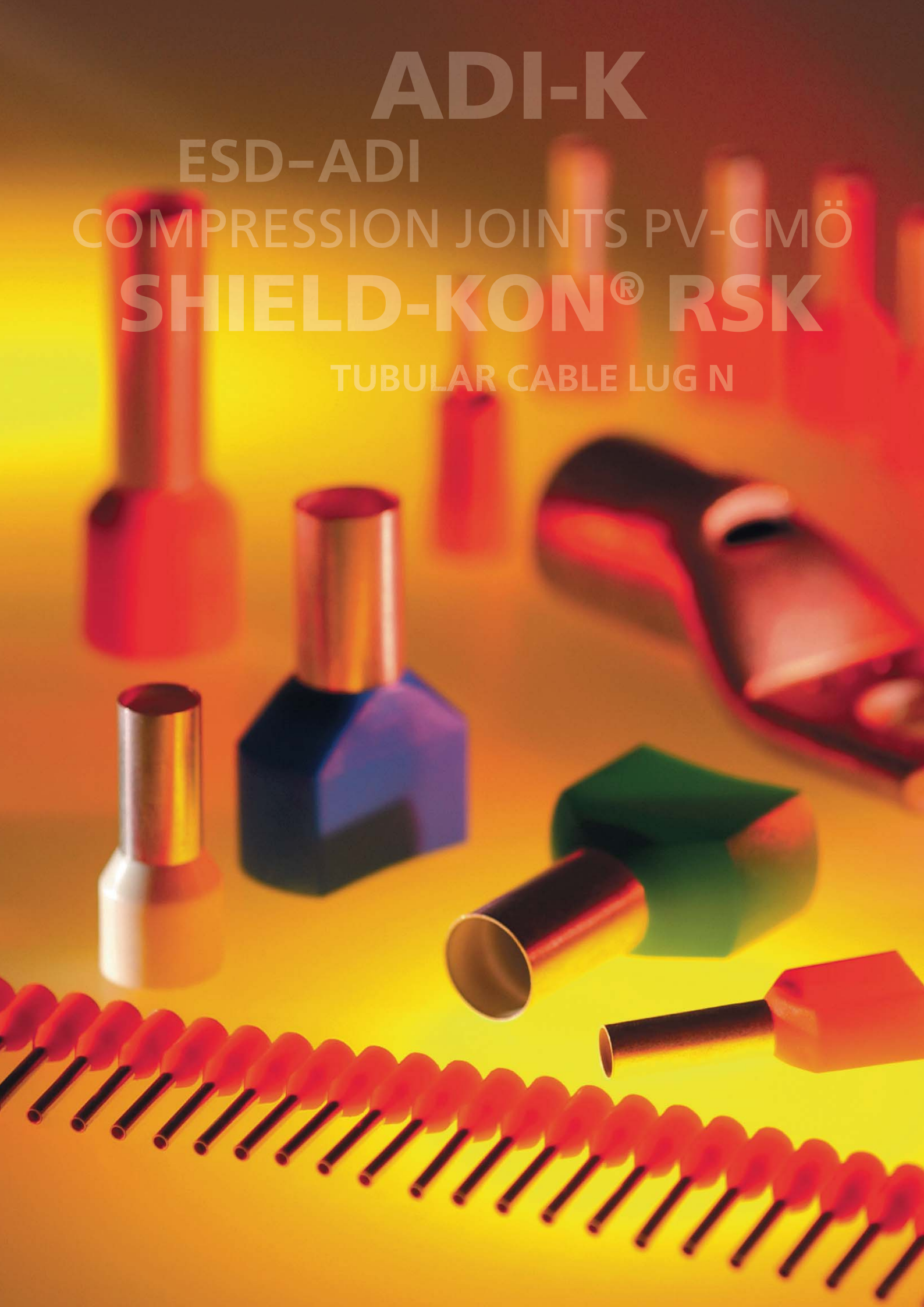

■ CORE END SLEEVES AND CABLE LUGS

Series/Material	Application area	Item	Page	
Core end sleeves				
insulated	for single conductors	ADI	380	
	reel packaging	ADI-B	382	
	assortment box	ESD-ADI	383	
	for short-circuit proof cables	ADI-K	384	
	for two conductors	DUO	385	
	assortment box	ESD-DUO	386	
not insulated	for single conductors	ADU	387	
Shield connectors				
insulated	Series T&B	Shield-Kon® RSK	389	
Solderless terminals				
insulated	Solderless terminals	Eye type	390	
		Forked, pin form	391	
		Round pin plugs	392	
		Butt connector, Closed end-splice	393	
		Push-on receptacle, Flat-pin plug	394	
		Push-on receptacle, Flat distributor	395	
	reel packaging	Eye type, forked	396	
	not insulated	Solderless terminals B	Eye type	397
			Forked	398
			Pin form	399
Tubular cable lugs				
		HELU-S-RK-CU	400	
		HELU-S-RK-CU-UL	401	
		HELU-S-RK-45-CU-UL	403	
		HELU-S-RK-90-CU-UL	405	
		HELU-S-RK-S-CU-UL	407	
		HELU-S-RK-F-CU	408	
		HELU-S-RK-N Nickel-tubular cable lug - straight	418	
Compression cable lug				
		HELU-S-PK-CU	410	
		HELU-S-PK-CU-DIN	412	
		HELU-S-PK-AL-DIN Aluminum compression cable lug - straight	414	
		HELU-S-PK-AL/CU-DIN Aluminum copper compression cable lug - straight	415	
Washer		KAC-U Al/ Cu bi-metalic washer	417	
Connector		HELU-S-SV-CU Copper connector	419	
Compression joints		HELU-S-PV-CU-DIN Copper compression joints	420	
		HELU-S-PV-AL-DIN Copper compression joints	421	
		HELU-S-PV-AL/CU Aluminium copper compression joints	422	



ADI

Insulated core end sleeves prevent stripped wires from fanning. The hopper-shaped plastic collar enables them to be pushed easily onto the wires. To DIN, ZF, and Telemecanique colour code.

Material

Socket: Copper
Surface: tinned

Insulating shroud: polypropylene

Technical data

Temperature range: up to +105°C
Temperature range temporary up to +120°C

Note

Assignment to cable cross section according to DIN 46228: up to 50mm² to nominal size and DIN color code - over 50mm² no specification; Assignment to suitable size possible.

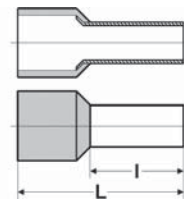

Dimensions

L Total length
l Stick length

Part no.	Size mm ²	Colour	Colour code	Total length mm	Stick length mm	Unit	Net EUR/100 items at a purchase of		
							up to 5000	5001 - 10000	10001 - 50000
91850	0,14 / normal	brown	Telemecanique	10,4	6,0	500	o. r.	o. r.	o. r.
91851	0,14 / long	brown	Telemecanique	12,4	8,0	500	o. r.	o. r.	o. r.
91852	0,25 / normal	violet	Telemecanique	10,4	6,0	500	o. r.	o. r.	o. r.
91853	0,25 / normal	light blue	Z+F	10,4	6,0	500	o. r.	o. r.	o. r.
91854	0,25 / long	violet	Telemecanique	12,4	8,0	500	o. r.	o. r.	o. r.
91855	0,25 / long	light blue	Z+F	12,4	8,0	500	o. r.	o. r.	o. r.
91856	0,34 / normal	pink	Telemecanique	10,4	6,0	500	o. r.	o. r.	o. r.
91857	0,34 / normal	turquoise	Z+F	10,4	6,0	500	o. r.	o. r.	o. r.
91858	0,34 / long	pink	Telemecanique	12,4	8,0	500	o. r.	o. r.	o. r.
91859	0,34 / long	turquoise	Z+F	12,4	8,0	500	o. r.	o. r.	o. r.
91860	0,5 / short	white	DIN	12,0	6,0	500	o. r.	o. r.	o. r.
91861	0,5 / short	orange	Z+F	12,0	6,0	500	o. r.	o. r.	o. r.
91350	0,5 / normal	white	DIN	14,0	8,0	500	o. r.	o. r.	o. r.
91383	0,5 / normal	orange	Z+F	14,0	8,0	500	o. r.	o. r.	o. r.
91862	0,5 / semi-long	white	DIN	16,0	10,0	500	o. r.	o. r.	o. r.
91863	0,5 / semi-long	orange	Z+F	16,0	10,0	500	o. r.	o. r.	o. r.
91864	0,75 / short	light blue	Telemecanique	12,4	6,0	500	o. r.	o. r.	o. r.
91865	0,75 / short	white	Z+F	12,4	6,0	500	o. r.	o. r.	o. r.
94023	0,75 / short	grey	DIN	12,4	6,0	500	o. r.	o. r.	o. r.
91351	0,75 / normal	light blue	Telemecanique	14,6	8,0	500	o. r.	o. r.	o. r.
91384	0,75 / normal	white	Z+F	14,6	8,0	500	o. r.	o. r.	o. r.
93030	0,75 / normal	grey	DIN	14,6	8,0	500	o. r.	o. r.	o. r.
91866	0,75 / semi-long	light blue	Telemecanique	16,4	10,0	500	o. r.	o. r.	o. r.
91867	0,75 / semi-long	white	Z+F	16,4	10,0	500	o. r.	o. r.	o. r.
91868	0,75 / semi-long	grey	DIN	16,4	10,0	500	o. r.	o. r.	o. r.
91869	0,75 / long	light blue	Telemecanique	18,4	12,0	500	o. r.	o. r.	o. r.
91870	0,75 / long	white	Z+F	18,4	12,0	500	o. r.	o. r.	o. r.

Continuation ►



Insulated

Part no.	Size mm ²	Colour	Colour code	Total length mm	Stick length mm	Unit	Net EUR/100 items at a purchase of		
							up to 5000	5001 - 10000	10001 - 50000
91871	0,75 / long	grey	DIN	18,4	12,0	500	o. r.	o. r.	o. r.
91872	1,0 / short	red	DIN	12,4	6,0	500	o. r.	o. r.	o. r.
91873	1,0 / short	yellow	Z+F	12,4	6,0	500	o. r.	o. r.	o. r.
91352	1,0 / normal	red	DIN	14,6	8,0	500	o. r.	o. r.	o. r.
91385	1,0 / normal	yellow	Z+F	14,6	8,0	500	o. r.	o. r.	o. r.
91874	1,0 / semi-long	red	DIN	16,4	10,0	500	o. r.	o. r.	o. r.
91875	1,0 / semi-long	yellow	Z+F	16,4	10,0	500	o. r.	o. r.	o. r.
91876	1,0 / long	red	DIN	18,4	12,0	500	o. r.	o. r.	o. r.
91877	1,0 / long	yellow	Z+F	18,4	12,0	500	o. r.	o. r.	o. r.
91353	1,5 / normal	black	DIN	14,6	8,0	500	o. r.	o. r.	o. r.
91386	1,5 / normal	red	Z+F	14,6	8,0	500	o. r.	o. r.	o. r.
91878	1,5 / semi-long	black	DIN	16,4	10,0	500	o. r.	o. r.	o. r.
91879	1,5 / semi-long	red	Z+F	16,4	10,0	500	o. r.	o. r.	o. r.
91880	1,5 / long	black	DIN	24,4	18,0	500	o. r.	o. r.	o. r.
91881	1,5 / long	red	Z+F	24,4	18,0	500	o. r.	o. r.	o. r.
91354	2,5 / normal	grey	Telemecanique	15,2	8,0	500	o. r.	o. r.	o. r.
91387	2,5 / normal	blue	DIN	15,2	8,0	500	o. r.	o. r.	o. r.
91882	2,5 / semi-long	grey	Telemecanique	19,0	12,0	500	o. r.	o. r.	o. r.
91883	2,5 / semi-long	blue	DIN	19,0	12,0	500	o. r.	o. r.	o. r.
91884	2,5 / long	grey	Telemecanique	25,0	18,0	500	o. r.	o. r.	o. r.
91885	2,5 / long	blue	DIN	25,0	18,0	500	o. r.	o. r.	o. r.
91355	4,0 / normal	orange	Telemecanique	16,5	10,0	500	o. r.	o. r.	o. r.
91388	4,0 / normal	grey	DIN	16,5	10,0	500	o. r.	o. r.	o. r.
91886	4,0 / semi-long	orange	Telemecanique	19,5	12,0	500	o. r.	o. r.	o. r.
91887	4,0 / semi-long	grey	DIN	19,5	12,0	500	o. r.	o. r.	o. r.
91888	4,0 / long	orange	Telemecanique	25,5	18,0	500	o. r.	o. r.	o. r.
91889	4,0 / long	grey	DIN	25,5	18,0	500	o. r.	o. r.	o. r.
91356	6,0 / normal	green	Telemecanique	20,0	12,0	100	o. r.	o. r.	o. r.
91389	6,0 / normal	black	Z+F	20,0	12,0	100	o. r.	o. r.	o. r.
93031	6,0 / normal	yellow	DIN	20,0	12,0	100	o. r.	o. r.	o. r.
91890	6,0 / long	green	Telemecanique	26,0	18,0	100	o. r.	o. r.	o. r.
91891	6,0 / long	black	Z+F	26,0	18,0	100	o. r.	o. r.	o. r.
91892	6,0 / long	yellow	DIN	26,0	18,0	100	o. r.	o. r.	o. r.
91357	10,0 / normal	brown	Telemecanique	21,5	12,0	100	o. r.	o. r.	o. r.
91390	10,0 / normal	ivory	Z+F	21,5	12,0	100	o. r.	o. r.	o. r.
93032	10,0 / normal	red	DIN	21,5	12,0	100	o. r.	o. r.	o. r.
91893	10,0 / long	brown	Telemecanique	27,5	18,0	100	o. r.	o. r.	o. r.
91894	10,0 / long	ivory	Z+F	27,5	18,0	100	o. r.	o. r.	o. r.
94024	10,0 / long	red	DIN	27,5	18,0	100	o. r.	o. r.	o. r.
91895	16,0 / normal	ivory	Telemecanique	22,2	12,0	100	o. r.	o. r.	o. r.
91896	16,0 / normal	green	Z+F	22,2	12,0	100	o. r.	o. r.	o. r.
91897	16,0 / normal	blue	DIN	22,2	12,0	100	o. r.	o. r.	o. r.
91898	16,0 / long	ivory	Telemecanique	28,2	18,0	100	o. r.	o. r.	o. r.
91899	16,0 / long	green	Z+F	28,2	18,0	100	o. r.	o. r.	o. r.
91900	16,0 / long	blue	DIN	28,2	18,0	100	o. r.	o. r.	o. r.
91359	25,0 / normal	black	Telemecanique	29,0	16,0	50	o. r.	o. r.	o. r.
91392	25,0 / normal	brown	Z+F	29,0	16,0	50	o. r.	o. r.	o. r.
93034	25,0 / normal	yellow	DIN	29,0	16,0	50	o. r.	o. r.	o. r.
91901	25,0 / long	black	Telemecanique	35,0	22,0	50	o. r.	o. r.	o. r.
91902	25,0 / long	brown	Z+F	35,0	22,0	50	o. r.	o. r.	o. r.
91903	25,0 / long	yellow	DIN	35,0	22,0	50	o. r.	o. r.	o. r.
91393	35,0 / normal	red	DIN	30,0	16,0	50	o. r.	o. r.	o. r.
91394	35,0 / normal	beige	Z+F	30,0	16,0	50	o. r.	o. r.	o. r.
91904	35,0 / long	red	DIN	39,0	25,0	50	o. r.	o. r.	o. r.
91905	35,0 / long	beige	Z+F	39,0	25,0	50	o. r.	o. r.	o. r.
91395	50,0 / normal	blue	DIN	36,4	20,0	50	o. r.	o. r.	o. r.
91396	50,0 / normal	oliv	Z+F	36,4	20,0	50	o. r.	o. r.	o. r.
91906	50,0 / long	blue	DIN	41,0	25,0	50	o. r.	o. r.	o. r.
91907	50,0 / long	oliv	Z+F	41,0	25,0	50	o. r.	o. r.	o. r.
91908	70,0 / normal	yellow	DIN	37,0	21,0	25	o. r.	o. r.	o. r.
91397	70,0 / long	yellow	DIN	43,0	27,0	25	o. r.	o. r.	o. r.
91909	95,0 / normal	red	DIN	44,0	25,0	25	o. r.	o. r.	o. r.
91910	120,0 / normal	blue	DIN	48,0	27,0	25	o. r.	o. r.	o. r.
91911	150,0 / normal	yellow	DIN	58,0	32,0	25	o. r.	o. r.	o. r.

Dimensions and specifications may be changed without prior notice.

o. r. = on request

ADI-B Core end sleeves

Insulated



ADI-B

Tape products for processing with Stripax-Plus (strip products) or automatic crimpers (coil products).

Insulated core end sleeves prevent stripped wires from fanning.

The hopper-shaped plastic collar enables them to be pushed easily onto the wires.

Material

Socket: Copper
Surface: tinned

Insulating shroud: polypropylene

Note

Delivery formats:
Strips: 1 item = 10 strips x 50 pcs.
Coils: Endless on cardboard coil

Technical data

Temperature range: up to +105°C
Temperature range temporary up to +120°C

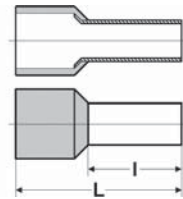

Dimensions

L Total length
l Stick length

Strip Part no.	Size mm ²	Colour	Colour code	Total length mm	Stick length mm	Unit	Net EUR/100 items at a purchase of		
							up to 5000	5001 - 10000	10001 - 50000
91912	0,5	white	DIN	14,0	8,0	500	o. r.	o. r.	o. r.
91913	0,5	orange	Z+F	14,0	8,0	500	o. r.	o. r.	o. r.
91914	0,75	grey	DIN	14,0	8,0	500	o. r.	o. r.	o. r.
91915	0,75	white	Z+F	14,0	8,0	500	o. r.	o. r.	o. r.
91916	0,75	light blue	Telemecanique	14,0	8,0	500	o. r.	o. r.	o. r.
91917	1,0	red	DIN	14,0	8,0	500	o. r.	o. r.	o. r.
91918	1,0	yellow	Z+F	14,0	8,0	500	o. r.	o. r.	o. r.
91919	1,5	black	DIN	14,0	8,0	500	o. r.	o. r.	o. r.
91920	1,5	red	Z+F	14,0	8,0	500	o. r.	o. r.	o. r.
91921	2,5	blue	DIN	14,0	8,0	500	o. r.	o. r.	o. r.
91922	2,5	grey	Telemecanique	14,0	8,0	500	o. r.	o. r.	o. r.

Coils Part no.	Size mm ²	Colour	Colour code	Total length mm	Stick length mm	Unit	Net EUR/100 items at a purchase of		
							up to 5000	5001 - 10000	10001 - 50000
93036	0,5	white	DIN	14,0	8,0	10000	o. r.	o. r.	o. r.
93037	0,5	orange	Z+F	14,0	8,0	10000	o. r.	o. r.	o. r.
93038	0,75	light blue	Telemecanique	14,0	8,0	10000	o. r.	o. r.	o. r.
93039	0,75	white	Z+F	14,0	8,0	10000	o. r.	o. r.	o. r.
93040	0,75	grey	DIN	14,0	8,0	10000	o. r.	o. r.	o. r.
93041	1,0	red	DIN	14,0	8,0	7500	o. r.	o. r.	o. r.
93042	1,0	yellow	Z+F	14,0	8,0	7500	o. r.	o. r.	o. r.
93043	1,5	black	DIN	14,0	8,0	7500	o. r.	o. r.	o. r.
93046	1,5	red	Z+F	14,0	8,0	7500	o. r.	o. r.	o. r.
93047	2,5	grey	Telemecanique	14,0	8,0	5000	o. r.	o. r.	o. r.
93048	2,5	blue	DIN	14,0	8,0	5000	o. r.	o. r.	o. r.

Dimensions and specifications may be changed without prior notice.

o. r. = on request

ESD-ADI Assortment box

Insulated

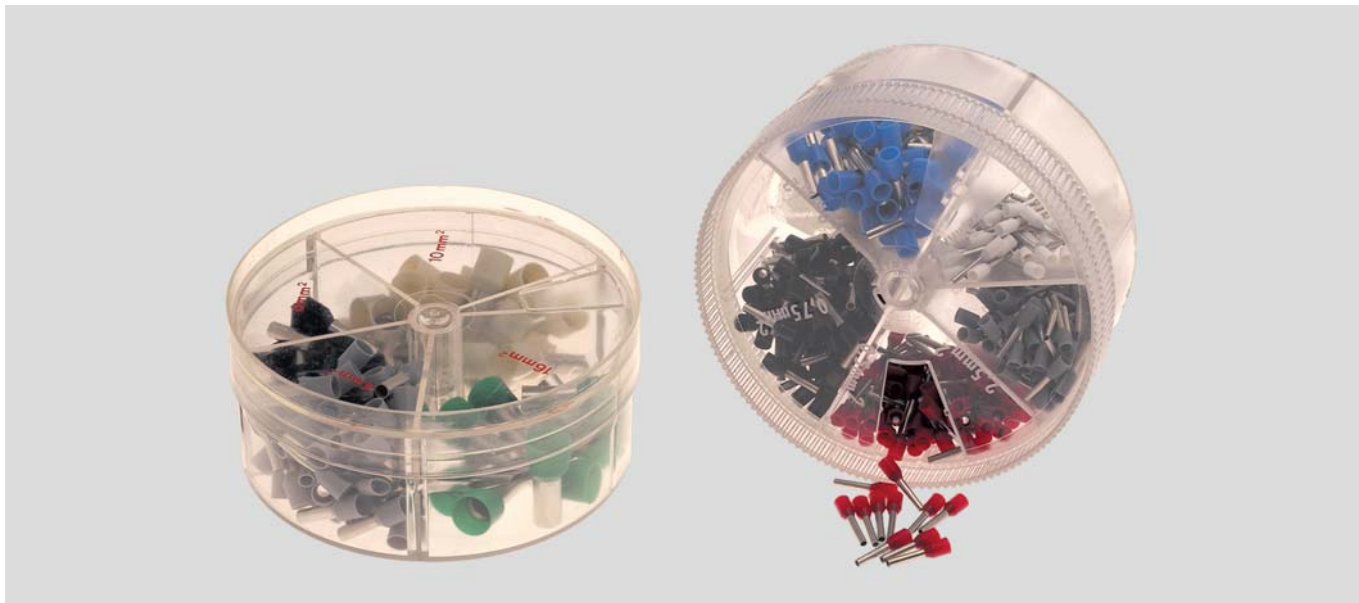

ESD-ADI

Practical pocket sized assortment box. Refillable, split into 4 or 5 compartments, with cross-section lettering. Refilling with ADI core end sleeves.

Material

Assortment box: PVC
Socket: Copper
Surface: tinned

Insulating shroud: Polypropylene

Note

Empty cans:

- ESD 3: 5-part with lettering 0.5 mm² / 0.75 mm² / 1.0 mm² / 1.5 mm² / 2.5 mm²
- ESD 4: 4-part with lettering 4.0 mm² / 6.0 mm² / 10.0 mm² / 16.0 mm²

All sizes in regular length.

Part no.	Type	Colour code	Filling case 1	Filling case 2	Filling case 3	Filling case 4	Filling case 5	Unit	Net EUR/item at a purchase of		
									1	2 - 5	6 - 10
96753	ESD 1	Telemecanique	50x0,5	100x0,75	100x1,0	100x1,5	50x2,5	1	o. r.	o. r.	o. r.
96604	ESD 11	Z+F	50x0,5	100x0,75	100x1,0	100x1,5	50x2,5	1	o. r.	o. r.	o. r.
96688	ESD 111	DIN	50x0,5	100x0,75	100x1,0	100x1,5	50x2,5	1	o. r.	o. r.	o. r.
96764	ESD 2	Telemecanique	50x4,0	20x6,0	20x10,0	10x16,0	Empty	1	o. r.	o. r.	o. r.
96749	ESD 22	Z+F	50x4,0	20x6,0	20x10,0	10x16,0	Empty	1	o. r.	o. r.	o. r.
96736	ESD 222	DIN	50x4,0	20x6,0	20x10,0	10x16,0	Empty	1	o. r.	o. r.	o. r.
96671	ESD 3	-	Empty	Empty	Empty	Empty	Empty	1	o. r.	o. r.	o. r.
96727	ESD 4	-	Empty	Empty	Empty	Empty	Empty	1	o. r.	o. r.	o. r.

Dimensions and specifications may be changed without prior notice.

o. r. = on request

ADI-K Core end sleeves - for short-circuit proof wires

Insulated



ADI-K

The core end sleeve is suitable for short circuit-proof wires. It prevents stripped wires from fanning. The hopper-shaped plastic collar enables them to be pushed easily onto the wires.

Material

Socket: Copper
Surface: tinned

Insulating shroud: polypropylene

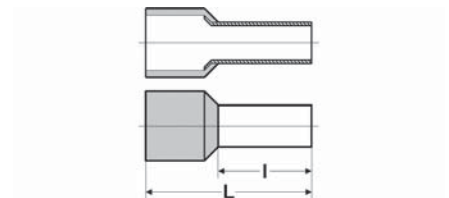

Dimensions

L Total length
l Stick length

Part no.	Size mm ²	Colour	Colour code	Total length mm	Stick length mm	Unit	Net EUR/100 items at a purchase of		
							up to 5000	5001 - 10000	10001 - 50000
91589	1,5 / normal	black	DIN	17,5	8,0	100	o. r.	o. r.	o. r.
91590	1,5 / long	black	DIN	19,5	10,0	100	o. r.	o. r.	o. r.
91591	2,5 / normal	blue	DIN	17,5	8,0	100	o. r.	o. r.	o. r.
91592	2,5 / long	blue	DIN	21,5	12,0	100	o. r.	o. r.	o. r.
97479	4,0 / normal	grey	DIN	19,5	10,0	100	o. r.	o. r.	o. r.
91593	6,0 / normal	yellow	DIN	23,0	12,0	100	o. r.	o. r.	o. r.
91595	10,0 / normal	red	DIN	24,0	12,0	100	o. r.	o. r.	o. r.
91598	16,0 / normal	blue	DIN	25,5	12,0	100	o. r.	o. r.	o. r.

Dimensions and specifications may be changed without prior notice.

o. r. = on request

DUO Core end sleeves

Insulated - for 2 conductors



DUO

Insulated DUO core end sleeves for insertion of 2 conductors prevent stripped wires from fanning.

The hopper-shaped plastic collar enables them to be pushed easily onto the wires.

To DIN, ZF, and Telemecanique colour code.

Material

Socket: Copper
Surface: tinned

Insulating shroud: polypropylene

Note

Versions:
N = normal
L = long

Technical data

Temperature range: up to +105°C

Temperature range temporary up to +120°C

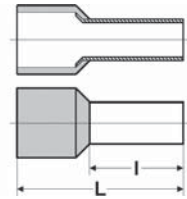

Dimensions

L Total length
l Stick length

Part no.	Size mm ²	Colour	Colour code	Total length mm	Stick length mm	Unit	Net EUR/100 items at a purchase of		
							up to 5000	5001 - 10000	10001 - 50000
91622	2x 0.5 / N	white	DIN	15,0	8,0	500	o. r.	o. r.	o. r.
91623	2x 0.5 / N	orange	Z+F	15,0	8,0	500	o. r.	o. r.	o. r.
91652	2x 0.75 / L	grey	DIN	17,0	10,0	500	o. r.	o. r.	o. r.
91671	2x 0.75 / L	light blue	Telemecanique	17,0	10,0	500	o. r.	o. r.	o. r.
91651	2x 0.75 / L	white	Z+F	17,0	10,0	500	o. r.	o. r.	o. r.
90125	2x 0.75 / N	grey	DIN	15,0	8,0	500	o. r.	o. r.	o. r.
91661	2x 0.75 / N	light blue	DIN	15,0	8,0	500	o. r.	o. r.	o. r.
91624	2x 0.75 / N	white	Z+F	15,0	8,0	500	o. r.	o. r.	o. r.
91653	2x 1 / L	red	DIN	17,0	10,0	500	o. r.	o. r.	o. r.
91654	2x 1 / L	yellow	Z+F	17,0	10,0	500	o. r.	o. r.	o. r.
90126	2x 1 / N	red	DIN	15,0	8,0	500	o. r.	o. r.	o. r.
91625	2x 1 / N	yellow	Z+F	15,0	8,0	500	o. r.	o. r.	o. r.
91655	2x 1.5 / L	black	DIN	20,0	12,0	500	o. r.	o. r.	o. r.
91672	2x 1.5 / L	red	Z+F	20,0	12,0	500	o. r.	o. r.	o. r.
90127	2x 1.5 / N	black	DIN	16,0	8,0	500	o. r.	o. r.	o. r.
91662	2x 1.5 / N	red	Z+F	16,0	8,0	500	o. r.	o. r.	o. r.
91656	2x 2.5 / L	blue	DIN	21,5	13,0	250	o. r.	o. r.	o. r.
91673	2x 2.5 / L	grey	Telemecanique	21,5	13,0	250	o. r.	o. r.	o. r.
90128	2x 2.5 / N	blue	DIN	18,5	10,0	250	o. r.	o. r.	o. r.
91663	2x 2.5 / N	grey	Telemecanique	18,5	10,0	250	o. r.	o. r.	o. r.
91626	2x 4 / N	grey	DIN	23,0	12,0	100	o. r.	o. r.	o. r.
91664	2x 4 / N	orange	Telemecanique	23,0	12,0	100	o. r.	o. r.	o. r.
91627	2x 6 / N	yellow	DIN	26,0	14,0	100	o. r.	o. r.	o. r.
91665	2x 6 / N	green	Telemecanique	26,0	14,0	100	o. r.	o. r.	o. r.
91666	2x 6 / N	black	Z+F	26,0	14,0	100	o. r.	o. r.	o. r.
91628	2x 10 / N	red	DIN	26,0	14,0	100	o. r.	o. r.	o. r.
91667	2x 10 / N	brown	Telemecanique	26,0	14,0	100	o. r.	o. r.	o. r.
91668	2x 10 / N	ivory	Z+F	26,0	14,0	100	o. r.	o. r.	o. r.
91629	2x 16 / N	blue	DIN	30,0	14,0	50	o. r.	o. r.	o. r.
91669	2x 16 / N	ivory	Telemecanique	30,0	14,0	50	o. r.	o. r.	o. r.
91670	2x 16 / N	green	Z+F	30,0	14,0	50	o. r.	o. r.	o. r.

Dimensions and specifications may be changed without prior notice.

o. r. = on request

ESD-DUO Assortment box

Insulated - for 2 conductors



ESD-DUO

Practical pocket sized assortment box. Refillable, split into 4 or 5 compartments, with cross-section lettering. Refilling with DUO core end sleeves.

Material

Assortment box: PVC
Socket: Copper
Surface: tinned

Insulating shroud: Polypropylene

Note

Empty cans:

- ESD 7: 4-part with lettering 2x0.75 mm² / 2x1.0 mm² / 2x1.5 mm² / 2x2.5 mm²
 - ESD 8: 4-part with lettering 2x4.0 mm² / 2x6.0 mm² / 2x1.0 mm² / 2x16.0 mm²
- All sizes in regular length.

ESD - DUO

Part no.	Type	Colour code	Filling					Unit	Net EUR/item at a purchase of		
			case 1	case 2	case 3	case 4	case 5		1	2 - 5	6 - 10
96617	ESD 5	DIN	50x0,75	50x1,0	50x1,5	50x2,5	Empty	1	o. r.	o. r.	o. r.
96648	ESD 6	DIN	20x4,0	10x6,0	10x10,0	5x16,0	Empty	1	o. r.	o. r.	o. r.
96629	ESD 7	-	Empty	Empty	Empty	Empty	Empty	1	o. r.	o. r.	o. r.
96652	ESD 8	-	Empty	Empty	Empty	Empty	Empty	1	o. r.	o. r.	o. r.

Dimensions and specifications may be changed without prior notice.

o. r. = on request

ADU Core end sleeves

Non insulated

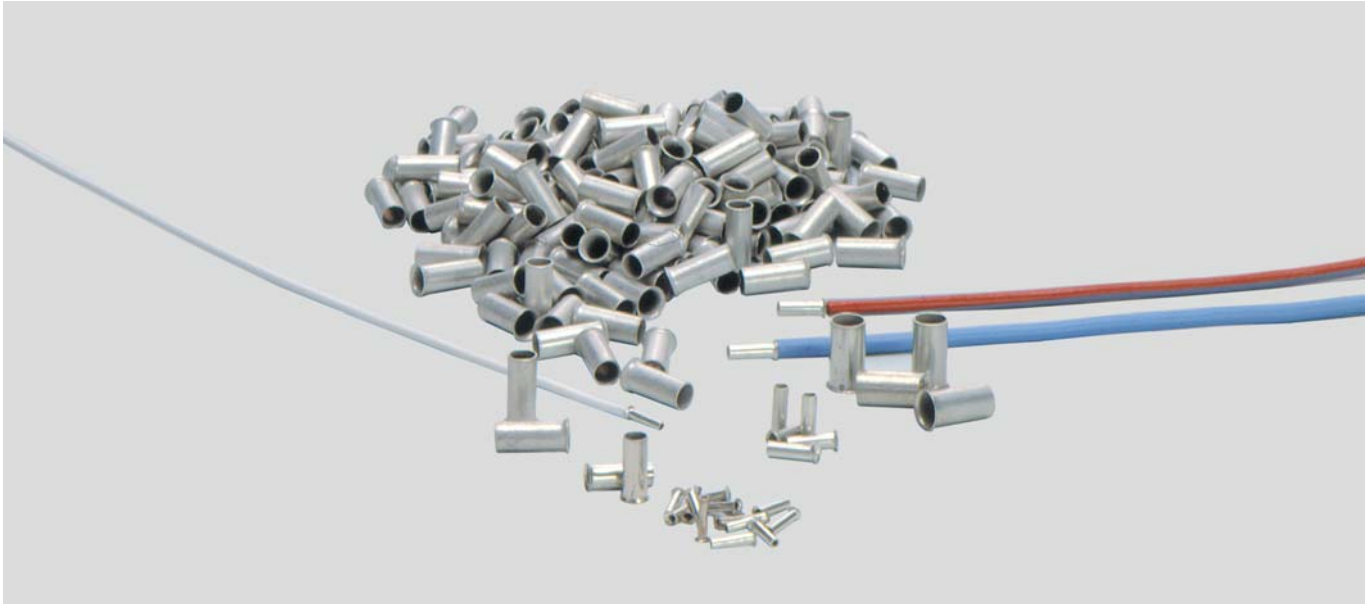

ADU

Non-insulated core end sleeves prevent stripped wires from fanning. The hopper-shaped socket enables them to be pushed easily onto the wires.

Material

Socket: Copper

Note

Assignment to cable cross section according to DIN 46228: up to 50mm² to nominal size - over 50mm² no specificatin; Assignment to suitable size possible.

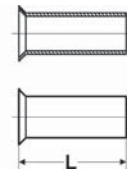

Dimensions

L Total length

Part no.	Size mm ²	Length mm	Unit	Net EUR/ 100 items at a purchase of		
				up to 5000	5001 - 10000	10001 - 50000
91368	0,5	6,0	1000	o. r.	o. r.	o. r.
91370	0,5	10,0	1000	o. r.	o. r.	o. r.
91371	0,75	6,0	1000	o. r.	o. r.	o. r.
91372	0,75	8,0	1000	o. r.	o. r.	o. r.
91373	1,0	6,0	1000	o. r.	o. r.	o. r.
91374	1,0	10,0	1000	o. r.	o. r.	o. r.
91375	1,5	7,0	1000	o. r.	o. r.	o. r.
91376	1,5	10,0	1000	o. r.	o. r.	o. r.
93096	2,5	7,0	1000	o. r.	o. r.	o. r.
93097	2,5	10,0	1000	o. r.	o. r.	o. r.
93099	4,0	9,0	1000	o. r.	o. r.	o. r.
94000	4,0	12,0	1000	o. r.	o. r.	o. r.
94001	6,0	10,0	250	o. r.	o. r.	o. r.
94002	6,0	12,0	250	o. r.	o. r.	o. r.
94003	6,0	15,0	250	o. r.	o. r.	o. r.
94004	10,0	12,0	250	o. r.	o. r.	o. r.
94005	10,0	15,0	250	o. r.	o. r.	o. r.
94006	10,0	18,0	250	o. r.	o. r.	o. r.
94007	16,0	12,0	250	o. r.	o. r.	o. r.
94008	16,0	15,0	250	o. r.	o. r.	o. r.
94009	16,0	18,0	250	o. r.	o. r.	o. r.
94010	25,0	12,0	100	o. r.	o. r.	o. r.
94011	25,0	15,0	100	o. r.	o. r.	o. r.
94012	25,0	18,0	100	o. r.	o. r.	o. r.
94013	25,0	25,0	100	o. r.	o. r.	o. r.
94014	25,0	32,0	100	o. r.	o. r.	o. r.
94015	35,0	18,0	100	o. r.	o. r.	o. r.
94016	35,0	25,0	100	o. r.	o. r.	o. r.
94018	35,0	32,0	100	o. r.	o. r.	o. r.
94019	50,0	18,0	100	o. r.	o. r.	o. r.
94020	50,0	22,0	100	o. r.	o. r.	o. r.
94021	70,0	25,0	100	o. r.	o. r.	o. r.
94022	70,0	32,0	100	o. r.	o. r.	o. r.
91030	95,0	25,0	50	o. r.	o. r.	o. r.
91031	95,0	32,0	50	o. r.	o. r.	o. r.
96841	120,0	32,0	50	o. r.	o. r.	o. r.

Dimensions and specifications may be changed without prior notice.

o. r. = on request

■ INSTALLATION METHODS AND PROCEDURE

SHIELD-KON® ONE-PIECE CONNECTOR

Processing method

Standard method

Use the standard method when the shielded cable or the inner conductors are embedded in a dielectric.

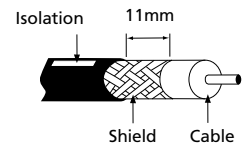

“Fold-back” – Method 1

If there is no common dielectric for several interior cables but the gaps are filled by textile threads or something similar, care should be taken to ensure that the insulating thickness of the individual cables is not less than 0.38 mm for PVC, and not less than 0.25 mm for Teflon. If this insulation thickness falls below this value, fold-back method 1 should be used.

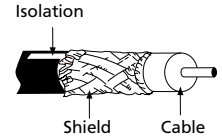

“Mid-Span” – Method

Allows installation anywhere along the cable.

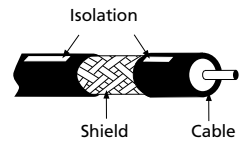

“Fold-back” – Method 2

Fold-back method 2 should be used if the cable shield is applied spirally or if a foil shield is being used.

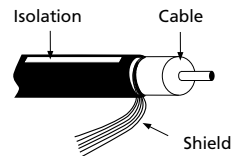

Installation procedures

Step 1

Prepare shielded wire and drain wire insulation as shown. If two earth wires are required, twist both conductors before insertion into the connector.

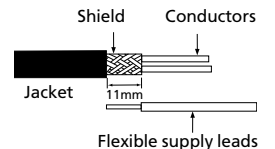

Step 2

Select the appropriate connector according to the size of the shielded cable. Adjusting the tool is not necessary. Place the 11 mm insulated drain wire around the trap hook and the shielded wire into the bottom of the connector.

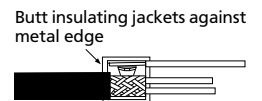

Step 3

Squeeze the tool handles firmly to crimp the connector around the shielding and the drain wire.

Connector opening faces away from tool

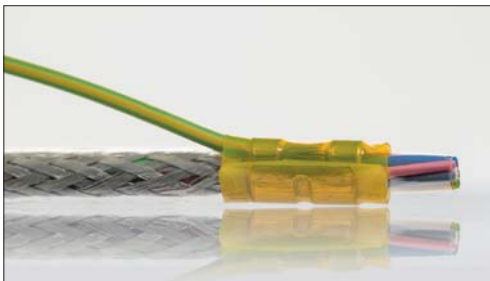
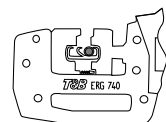

Shield Kon® RSK Shield connectors

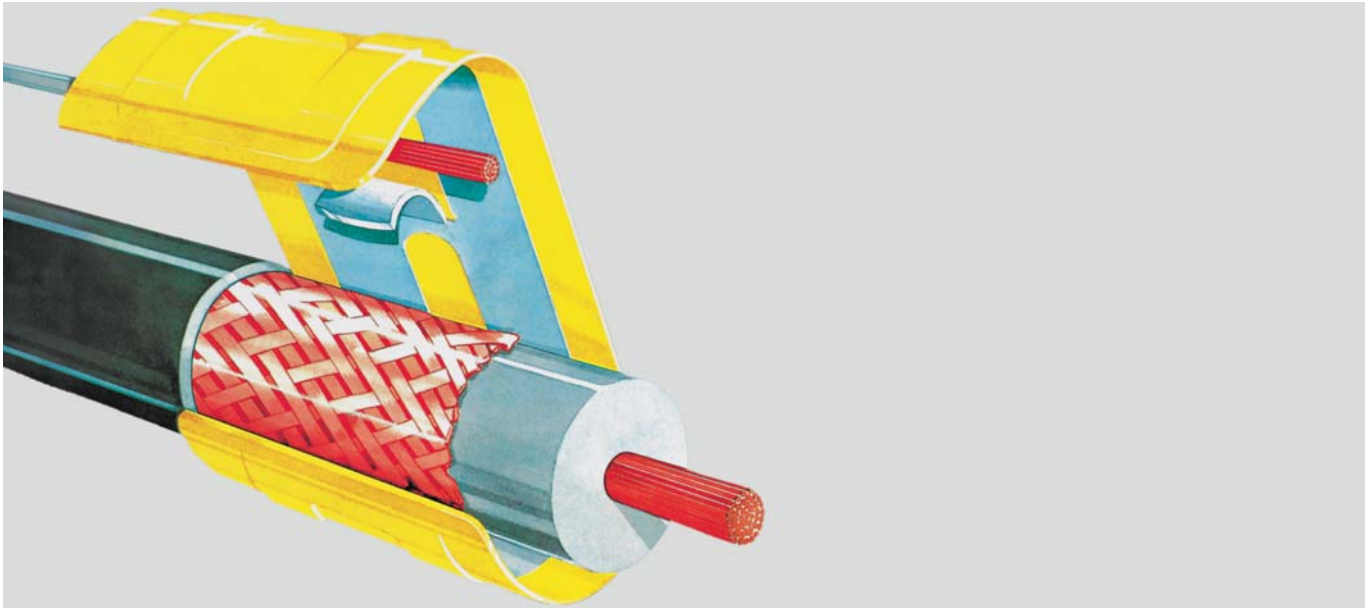

Shield Kon®

Shield connectors are crimped like a cable lug. The special crimping technique using ERG tools enables the connector to roll around the sheath. Inside the connector is a clevis-type connector for the connector strip and a support for the sheathed cable.
ERG 740 processing tool

Material

Copper
Surface: tinned

Insulation: Polyester film

Note

Processing tool ERG and the matching inserts see chapter "Tools".
Processing method see chapter "Technical information".

Technical data

Temperature range: -40°C up to +125°C

Part no.	Type	Colour code	Shield Ø mm	Tool insets	Unit	Net EUR/100 items at a purchase of		
						up to 500	501 - 1000	1001 - 5000
91280	RSK 101	red	1,27 - 1,79	D-101 A	100	o. r.	o. r.	o. r.
91280	RSK 101	red	1,80 - 2,28	D-101 B	100	o. r.	o. r.	o. r.
91281	RSK 201	blue	2,29 - 2,55	D-201 C	100	o. r.	o. r.	o. r.
91281	RSK 201	blue	2,56 - 3,00	D-201 D	100	o. r.	o. r.	o. r.
91281	RSK 201	blue	3,01 - 3,34	D-201 E	100	o. r.	o. r.	o. r.
91281	RSK 201	blue	3,35 - 3,65	D-201 F	100	o. r.	o. r.	o. r.
91282	RSK 301	yellow	3,66 - 4,13	D-301 G	100	o. r.	o. r.	o. r.
91282	RSK 301	yellow	4,14 - 4,71	D-301 H	100	o. r.	o. r.	o. r.
91282	RSK 301	yellow	4,72 - 5,12	D-301 J	100	o. r.	o. r.	o. r.
91283	RSK 401	green	5,13 - 5,86	D-401 K	100	o. r.	o. r.	o. r.
91283	RSK 401	green	5,87 - 6,36	D-401 L	100	o. r.	o. r.	o. r.
91283	RSK 401	green	6,37 - 7,00	D-401 M	100	o. r.	o. r.	o. r.
91283	RSK 401	green	7,01 - 7,62	D-401 N	100	o. r.	o. r.	o. r.

Dimensions and specifications may be changed without prior notice.

o. r. = on request

Solderless terminals

Insulated - eye type



Insulated solderless terminals

PA insulated solderless terminals for cross sections of 0.1 to 16.0mm². Simple cable inlet through Easy-Entry (expanded sleeve). Insulated with high dielectric strength.

Material

Socket: Copper
Surface: tinned

Insulation: partially-insulated

Technical data

Temperature range: -60°C up to +125°C

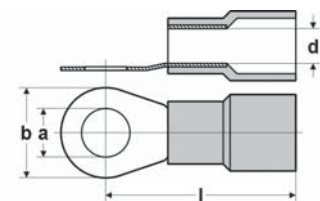

Dimensions

- a Diameter of the boring
- d Inner diameter of the cable insertion
- b Flange width
- l Length till middle of the boring

Eye type

Part no.	Type	Colour	Cross-section mm ²	Connection bolts M	Design	Unit	Net EUR/100 items at a purchase of		
							up to 500	501 - 1000	1001 - 5000
91475	HZ 3	yellow	0,1 - 0,5	3,2	eye type	100	o. r.	o. r.	o. r.
91476	HZ 4	yellow	0,1 - 0,5	4,3	eye type	100	o. r.	o. r.	o. r.
91477	HZ 5	yellow	0,1 - 0,5	5,3	eye type	100	o. r.	o. r.	o. r.
91478	HA 3	red	0,5 - 1,5	3,2	eye type	100	o. r.	o. r.	o. r.
91479	HA 3,5	red	0,5 - 1,5	3,7	eye type	100	o. r.	o. r.	o. r.
91480	HA 4	red	0,5 - 1,5	4,3	eye type	100	o. r.	o. r.	o. r.
91481	HA 5	red	0,5 - 1,5	5,3	eye type	100	o. r.	o. r.	o. r.
91849	HA 5S	red	0,5 - 1,5	5,7	eye type	100	o. r.	o. r.	o. r.
91482	HA 6	red	0,5 - 1,5	6,5	eye type	100	o. r.	o. r.	o. r.
96776	HA 8	red	0,5 - 1,5	8,4	eye type	100	o. r.	o. r.	o. r.
91483	HB 3	blue	1,5 - 2,5	3,2	eye type	100	o. r.	o. r.	o. r.
91484	HB 4	blue	1,5 - 2,5	4,3	eye type	100	o. r.	o. r.	o. r.
91485	HB 5	blue	1,5 - 2,5	5,3	eye type	100	o. r.	o. r.	o. r.
94944	HB 5S	blue	1,5 - 2,5	5,7	eye type	100	o. r.	o. r.	o. r.
91486	HB 6	blue	1,5 - 2,5	6,5	eye type	100	o. r.	o. r.	o. r.
91487	HB 8	blue	1,5 - 2,5	8,4	eye type	100	o. r.	o. r.	o. r.
97696	HB 10	blue	1,5 - 2,5	10,5	eye type	100	o. r.	o. r.	o. r.
91488	HC 4	yellow	2,5 - 6,0	4,3	eye type	100	o. r.	o. r.	o. r.
91489	HC 5	yellow	2,5 - 6,0	5,3	eye type	100	o. r.	o. r.	o. r.
91490	HC 6	yellow	2,5 - 6,0	6,5	eye type	100	o. r.	o. r.	o. r.
91491	HC 8	yellow	2,5 - 6,0	8,4	eye type	100	o. r.	o. r.	o. r.
91492	HC 10	yellow	2,5 - 6,0	10,5	eye type	100	o. r.	o. r.	o. r.
96607	HD 5	red	10,0	5,3	eye type	50	o. r.	o. r.	o. r.
90055	HD 6	red	10,0	6,5	eye type	50	o. r.	o. r.	o. r.
96400	HD 8	red	10,0	8,4	eye type	50	o. r.	o. r.	o. r.
96616	HD 10	red	10,0	10,5	eye type	50	o. r.	o. r.	o. r.
96620	HE 5	blue	16,0	5,3	eye type	50	o. r.	o. r.	o. r.
96401	HE 6	blue	16,0	6,5	eye type	50	o. r.	o. r.	o. r.
96402	HE 8	blue	16,0	8,4	eye type	50	o. r.	o. r.	o. r.
90056	HE 10	blue	16,0	10,5	eye type	50	o. r.	o. r.	o. r.
90057	HE 12	blue	16,0	13	eye type	50	o. r.	o. r.	o. r.

Dimensions and specifications may be changed without prior notice.

o. r. = on request

Solderless terminals

Insulated



Insulated solderless terminals

PA insulated solderless terminals for cross sections of 0.25 to 6.0mm². Simple cable inlet through Easy-Entry (expanded sleeve). Insulated with high dielectric strength.

Material

Socket: Copper
Surface: tinned

Insulation: Partially-insulated, PA

Technical data

Temperature range: -60°C up to +125°C

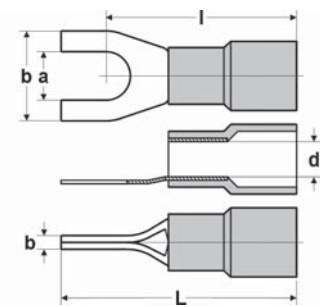

Forked

Part no.	Type	Colour	Cross-section mm ²	Connection bolts M	Design	Unit	Net EUR/100 items at a purchase of		
							up to 500	501 - 1000	1001 - 5000
91403	HA 35F	red	0,5 - 1,5	3,7	Fork-type cable lug	100	o. r.	o. r.	o. r.
91404	HA 4F	red	0,5 - 1,5	4,3	Fork-type cable lug	100	o. r.	o. r.	o. r.
91405	HA 5F	red	0,5 - 1,5	5,3	Fork-type cable lug	100	o. r.	o. r.	o. r.
91406	HA 6F	red	0,5 - 1,5	6,5	Fork-type cable lug	100	o. r.	o. r.	o. r.
91408	HB 3F	blue	1,5 - 2,5	3,2	Fork-type cable lug	100	o. r.	o. r.	o. r.
91409	HB 35F	blue	1,5 - 2,5	3,7	Fork-type cable lug	100	o. r.	o. r.	o. r.
91410	HB 4F	blue	1,5 - 2,5	4,3	Fork-type cable lug	100	o. r.	o. r.	o. r.
91411	HB 5F	blue	1,5 - 2,5	5,3	Fork-type cable lug	100	o. r.	o. r.	o. r.
91412	HB 6F	blue	1,5 - 2,5	6,5	Fork-type cable lug	100	o. r.	o. r.	o. r.
91415	HC 4F	yellow	2,5 - 6,0	4,3	Fork-type cable lug	100	o. r.	o. r.	o. r.
91416	HC 5F	yellow	2,5 - 6,0	5,3	Fork-type cable lug	100	o. r.	o. r.	o. r.
91417	HC 6F	yellow	2,5 - 6,0	6,5	Fork-type cable lug	100	o. r.	o. r.	o. r.

Pin form

Part no.	Type	Colour	Cross-section mm ²	Connection bolts M	Design	Unit	Net EUR/100 items at a purchase of		
							up to 500	501 - 1000	1001 - 5000
91418	HZP	yellow	0,1 - 0,5	-	Pin-type cable lug	100	o. r.	o. r.	o. r.
91419	HAP	red	0,5 - 1,5	-	Pin-type cable lug	100	o. r.	o. r.	o. r.
91420	HBP	blue	1,5 - 2,5	-	Pin-type cable lug	100	o. r.	o. r.	o. r.
91421	HCP	yellow	2,5 - 6,0	-	Pin-type cable lug	100	o. r.	o. r.	o. r.
96575	HDP	red	10,0	-	Pin-type cable lug	100	o. r.	o. r.	o. r.
96576	HEP	blue	16,0	-	Pin-type cable lug	100	o. r.	o. r.	o. r.

Dimensions and specifications may be changed without prior notice.

o. r. = on request

Solderless terminals

Insulated



Insulated solderless terminals

PA insulated solderless terminals for cross sections of 0.25 to 6.0mm². Simple cable inlet through Easy-Entry (expanded sleeve). Insulated with high dielectric strength.

Material

Socket: Copper
Surface: tinned

Insulation: Partially-insulated, PA

Technical data

Temperature range: -60°C up to +125°C

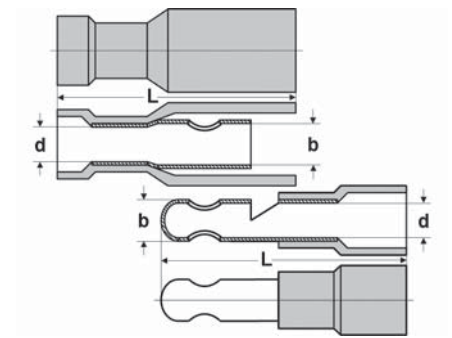

Round pin plugs

Part no.	Type	Colour	Cross-section mm ²	Connection bolts M	Design	Unit	Net EUR/100 items at a purchase of		
							up to 500	501 - 1000	1001 - 5000
91422	HABM	red	0,5 - 1,5	-	Plug	100	o. r.	o. r.	o. r.
91423	HAB	red	0,5 - 1,5	-	Sleeve	100	o. r.	o. r.	o. r.
91424	HB 5BM	blue	1,5 - 2,5	-	Plug	100	o. r.	o. r.	o. r.
91425	HB 5B	blue	1,5 - 2,5	-	Sleeve	100	o. r.	o. r.	o. r.
96594	HC 5BM	yellow	2,5 - 6,0	-	Plug	100	o. r.	o. r.	o. r.
96595	HC 5B	yellow	2,5 - 6,0	-	Sleeve	100	o. r.	o. r.	o. r.

Dimensions and specifications may be changed without prior notice.

o. r. = on request

Solderless terminals

Insulated



Insulated solderless terminals

Insulated solderless terminals for cross sections of 0.25 to 6.0 mm². Simple cable inlet through Easy-Entry (expanded sleeve). Insulated with high dielectric strength.

Material

Socket: Copper
Surface: tinned

Insulation: Partially-insulated, PA

Technical data

Temperature range: -60°C up to +125°C

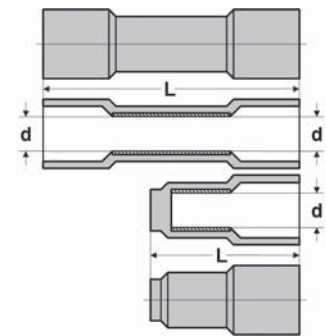

Butt connector

Part no.	Type	Colour	Cross-section mm ²	Connection bolts M	Design	Unit	Net EUR/100 items at a purchase of		
							up to 500	501 - 1000	1001 - 5000
91426	HAA 15	red	0,5 - 1,5	-	Connector	100	o. r.	o. r.	o. r.
91427	HBB 25	blue	1,5 - 2,5	-	Connector	100	o. r.	o. r.	o. r.
91429	HCC 6	yellow	2,5 - 6,0	-	Connector	100	o. r.	o. r.	o. r.

Closed end-splices

Part no.	Type	Colour	Cross-section mm ²	Connection bolts M	Design	Unit	Net EUR/100 items at a purchase of		
							up to 500	501 - 1000	1001 - 5000
91398	HAI	transparent	0,5 - 1,5	-	Terminal connector	100	o. r.	o. r.	o. r.
91428	HBJ	transparent	1,5 - 2,5	-	Terminal connector	100	o. r.	o. r.	o. r.
91430	HCJ	transparent	2,5 - 6,0	-	Terminal connector	100	o. r.	o. r.	o. r.

Dimensions and specifications may be changed without prior notice.

o. r. = on request

Solderless terminals

Insulated



Insulated solderless terminals

PA insulated solderless terminals for cross sections of 0.5 to 6.0mm².
Simple cable inlet through Easy-Entry.

Material

Socket: Copper
Surface: tinned

Insulation: PA

Technical data

Temperature range: -25°C up to +105°C

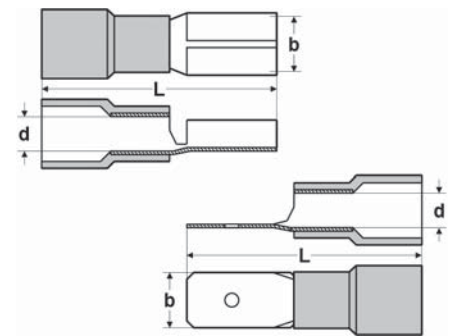

Push-on receptacle

Part no.	Type	Colour	Cross-section mm ²	Flat plug size mm	Design	Unit	Net EUR/100 items at a purchase of		
							up to 500	501 - 1000	1001 - 5000
91432	RA 29	red	0,5 - 1,5	flat, 2,8 x 0,5 mm	Sleeve	100	o. r.	o. r.	o. r.
91431	RA 28	red	0,5 - 1,5	flat, 2,8 x 0,8 mm	Sleeve	100	o. r.	o. r.	o. r.
91434	RA 48	red	0,5 - 1,5	flat, 4,8 x 0,8 mm	Sleeve	100	o. r.	o. r.	o. r.
91433	RA 49	red	0,5 - 1,5	flat, 4,8 x 0,5 mm	Sleeve	100	o. r.	o. r.	o. r.
91435	RA 63	red	0,5 - 1,5	flat, 6,3 x 0,8 mm	Sleeve	100	o. r.	o. r.	o. r.
96428	RB 28	blue	1,5 - 2,5	flat, 2,8 x 0,8 mm	Sleeve	100	o. r.	o. r.	o. r.
96415	RB 29	blue	1,5 - 2,5	flat, 2,8 x 0,5 mm	Sleeve	100	o. r.	o. r.	o. r.
91438	RB 48	blue	1,5 - 2,5	flat, 4,8 x 0,8 mm	Sleeve	100	o. r.	o. r.	o. r.
91439	RB 49	blue	1,5 - 2,5	flat, 4,8 x 0,5 mm	Sleeve	100	o. r.	o. r.	o. r.
91440	RB 63	blue	1,5 - 2,5	flat, 6,3 x 0,8 mm	Sleeve	100	o. r.	o. r.	o. r.
91443	RC 63	yellow	2,5 - 6,0	flat, 6,3 x 0,8 mm	Sleeve	100	o. r.	o. r.	o. r.
91445	RC 95	yellow	2,5 - 6,0	flat, 9,5 x 1,2 mm	Sleeve	100	o. r.	o. r.	o. r.

Flat-pin plug

Part no.	Type	Colour	Cross-section mm ²	Flat plug size mm	Design	Unit	Net EUR/100 items at a purchase of		
							up to 500	501 - 1000	1001 - 5000
98700	RA 29 M	red	0,5 - 1,5	flat, 2,8 x 0,5 mm	Plug	100	o. r.	o. r.	o. r.
98701	RA 28 M	red	0,5 - 1,5	flat, 2,8 x 0,8 mm	Plug	100	o. r.	o. r.	o. r.
98584	RA 48 M	red	0,5 - 1,5	flat, 4,8 x 0,8 mm	Plug	100	o. r.	o. r.	o. r.
98577	RA 49 M	red	0,5 - 1,5	flat, 4,8 x 0,5 mm	Plug	100	o. r.	o. r.	o. r.
91437	RA 63 M	red	0,5 - 1,5	flat, 6,3 x 0,8 mm	Plug	100	o. r.	o. r.	o. r.
98599	RB 48 M	blue	1,5 - 2,5	flat, 4,8 x 0,8 mm	Plug	100	o. r.	o. r.	o. r.
98598	RB 49 M	blue	1,5 - 2,5	flat, 4,8 x 0,5 mm	Plug	100	o. r.	o. r.	o. r.
91442	RB 63 M	blue	1,5 - 2,5	flat, 6,3 x 0,8 mm	Plug	100	o. r.	o. r.	o. r.
91444	RC 63 M	yellow	2,5 - 6,0	flat, 6,3 x 0,8 mm	Plug	100	o. r.	o. r.	o. r.

Dimensions and specifications may be changed without prior notice.

o. r. = on request

Solderless terminals

Insulated



Insulated squeeze snap-on connection

Insulated squeeze snap-on connection for cross sections of 0.5 to 6.0 mm².

Simple cable inlet through Easy-Entry (expanded sleeve).

Insulated with high dielectric strength.

Material

Socket: Copper
Surface: tinned

Insulation: fully-insulated

Note

Versions:

Flat connector (insulated / fully insulated)

Flat connector sleeves (insulated / fully insulated)

Flat connector distributor

Technical data

Temperature range: -25°C up to +105°C

Push-on receptacle, all-insulated

Part no.	Type	Colour	Cross-section mm ²	Flat plug size mm	Design	Unit	Net EUR/ 100 items at a purchase of		
							up to 500	501 - 1000	1001 - 5000
96574	RA 28 V0	red	0,5 - 1,0	flat, 2,8 x 0,8 mm	Sleeve	100	o. r.	o. r.	o. r.
96328	RA 29 V0	red	0,5 - 1,5	flat, 2,8 x 0,5 mm	Sleeve	100	o. r.	o. r.	o. r.
96329	RA 48 V0	red	0,5 - 1,5	flat, 4,8 x 0,8 mm	Sleeve	100	o. r.	o. r.	o. r.
96330	RA 49 V0	red	0,5 - 1,5	flat, 4,8 x 0,5 mm	Sleeve	100	o. r.	o. r.	o. r.
96334	RA 63 V0	red	0,5 - 1,5	flat, 6,3 x 0,8 mm	Sleeve	100	o. r.	o. r.	o. r.
96331	RB 48 V0	blue	1,5 - 2,5	flat, 4,8 x 0,8 mm	Sleeve	100	o. r.	o. r.	o. r.
96332	RB 49 V0	blue	1,5 - 2,5	flat, 4,8 x 0,5 mm	Sleeve	100	o. r.	o. r.	o. r.
96335	RB 63 V0	blue	1,5 - 2,5	flat, 6,3 x 0,8 mm	Sleeve	100	o. r.	o. r.	o. r.
96333	RC 63 V0	yellow	2,5 - 6,0	flat, 6,3 x 0,8 mm	Sleeve	100	o. r.	o. r.	o. r.

Flat distributor

Part no.	Type	Colour	Cross-section mm ²	Flat plug size mm	Design	Unit	Net EUR/ 100 items at a purchase of		
							up to 500	501 - 1000	1001 - 5000
91436	RA 63 T	red	0,5 - 1,5	flat, 6,3 x 0,8 mm	Distributor	100	o. r.	o. r.	o. r.
91441	RB 63 T	blue	1,5 - 2,5	flat, 6,3 x 0,8 mm	Distributor	100	o. r.	o. r.	o. r.
94929	RC 63 T	yellow	2,5 - 6,0	flat, 6,3 x 0,8 mm	Distributor	100	o. r.	o. r.	o. r.

Dimensions and specifications may be changed without prior notice.

o. r. = on request

Solderless terminals

Insulated - tape product

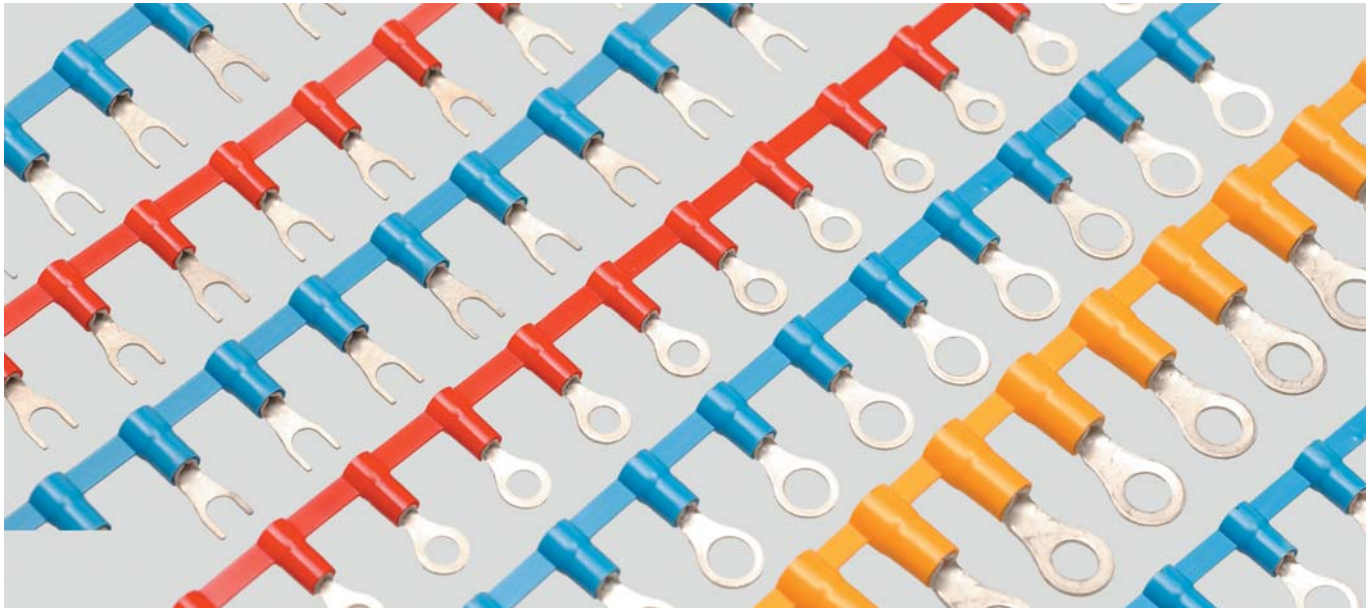

Solderless terminals, tape product

Polycarbonate-insulated connection material on tape has been developed as a cost-effective solution for medium and large pre-fabricated cables.

Material

Socket: Brass
Surface: tinned

Insulation: partially-insulated

Note

Roll diameter 450mm
Inner diameter of inclusion 27mm
Blade terminal / blade receptacle / pin-type cable lug on tape on request.

Technical data

Temperature range: -20°C up to +115°C
Temperature range temporary up to +130°C
Self-extinguishing acc. to UL 94 V0

Eye type

Part no.	Type	Colour	Cross-section mm ²	Unit	Net EUR/ 100 items at a purchase of		
					up to 5000	5001 - 10000	10001 - 50000
93740	BHA 3	red	0,25 - 1,5	2000	o. r.	o. r.	o. r.
93741	BHA 35	red	0,25 - 1,5	2000	o. r.	o. r.	o. r.
93742	BHA 4	red	0,25 - 1,5	2000	o. r.	o. r.	o. r.
93743	BHA 5	red	0,25 - 1,5	2000	o. r.	o. r.	o. r.
93744	BHA 6	red	0,25 - 1,5	2000	o. r.	o. r.	o. r.
93745	BHB 3	blue	1,5 - 2,5	1750	o. r.	o. r.	o. r.
93746	BHB 4	blue	1,5 - 2,5	1750	o. r.	o. r.	o. r.
93747	BHB 5	blue	1,5 - 2,5	1750	o. r.	o. r.	o. r.
93748	BHB 6	blue	1,5 - 2,5	1750	o. r.	o. r.	o. r.
93749	BHB 8	blue	1,5 - 2,5	1750	o. r.	o. r.	o. r.
93750	BHC 4	yellow	4,0 - 6,0	1250	o. r.	o. r.	o. r.
93751	BHC 5	yellow	4,0 - 6,0	1250	o. r.	o. r.	o. r.
93752	BHC 6	yellow	4,0 - 6,0	1250	o. r.	o. r.	o. r.
93753	BHC 8	yellow	4,0 - 6,0	1250	o. r.	o. r.	o. r.

Forked

Part no.	Type	Colour	Cross-section mm ²	Unit	Net EUR/ 100 items at a purchase of		
					up to 5000	5001 - 10000	10001 - 50000
93754	BHA 35 F	red	0,25 - 1,5	2000	o. r.	o. r.	o. r.
93755	BHA 4 F	red	0,25 - 1,5	2000	o. r.	o. r.	o. r.
93756	BHA 5 F	red	0,25 - 1,5	2000	o. r.	o. r.	o. r.
93757	BHA 6 F	red	0,25 - 1,5	2000	o. r.	o. r.	o. r.
93758	BHB 3 F	blue	1,5 - 2,5	1750	o. r.	o. r.	o. r.
93759	BHB 35 F	blue	1,5 - 2,5	1750	o. r.	o. r.	o. r.
93760	BHB 4 F	blue	1,5 - 2,5	1750	o. r.	o. r.	o. r.
93761	BHB 5 F	blue	1,5 - 2,5	1750	o. r.	o. r.	o. r.
93762	BHB 6 F	blue	1,5 - 2,5	1750	o. r.	o. r.	o. r.
93763	BHC 4 F	yellow	4,0 - 6,0	1250	o. r.	o. r.	o. r.
93764	BHC 5 F	yellow	4,0 - 6,0	1250	o. r.	o. r.	o. r.
93765	BHC 6 F	yellow	4,0 - 6,0	1250	o. r.	o. r.	o. r.

Dimensions and specifications may be changed without prior notice.

o. r. = on request

B Solderless terminals

Non insulated



Solderless terminals type B

Non-insulated solderless terminals in eye type design.

Material

Copper
Surface: tinned

Technical data

Temperature range: up to +125°C

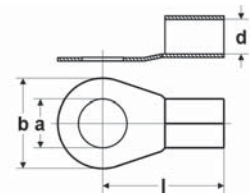

Dimensions

- a Diameter of the boring
- d Inner diameter of the cable insertion
- b Flange width
- l Length till middle of the boring

Eye type

Part no.	Type	Cross-section mm ²	a mm	b mm	d mm	t mm	l mm	Weight kg / 1000 items	Unit	Net EUR/100 items at a purchase of		
										up to 500	501 - 1000	1001 - 5000
91514	B 1-3	0,5-1,5	3,2	6,0	1,6	1,0	11,0	0,7	100	o. r.	o. r.	o. r.
91515	B 1-4	0,5-1,5	4,3	8,0	1,6	1,0	12,0	0,8	100	o. r.	o. r.	o. r.
91516	B 1-5	0,5-1,5	5,3	10,0	1,6	1,0	13,0	0,8	100	o. r.	o. r.	o. r.
91517	B 2,5-3	1,5-2,5	3,2	6,0	2,3	1,0	11,0	0,6	100	o. r.	o. r.	o. r.
91518	B 2,5-4	1,5-2,5	4,3	8,0	2,3	1,0	12,0	0,8	100	o. r.	o. r.	o. r.
91519	B 2,5-5	1,5-2,5	5,3	10,0	2,3	1,0	14,0	0,9	100	o. r.	o. r.	o. r.
91520	B 2,5-6	1,5-2,5	6,5	11,0	2,3	1,0	16,0	1,1	100	o. r.	o. r.	o. r.
91521	B 6-4	2,5-6,0	4,3	8,0	3,6	1,0	14,0	1,4	100	o. r.	o. r.	o. r.
91522	B 6-5	2,5-6,0	5,3	10,0	3,6	1,0	15,0	1,5	100	o. r.	o. r.	o. r.
91523	B 6-6	2,5-6,0	6,5	11,0	3,6	1,0	16,0	1,6	100	o. r.	o. r.	o. r.
91524	B 6-8	2,5-6,0	8,4	14,0	3,6	1,0	19,0	2,1	100	o. r.	o. r.	o. r.
91525	B 10-5	10	5,3	10,0	4,5	1,1	16,0	2,3	100	o. r.	o. r.	o. r.
91526	B 10-6	10	6,5	11,0	4,5	1,1	17,0	2,4	100	o. r.	o. r.	o. r.
91527	B 10-8	10	8,4	14,0	4,5	1,1	20,0	2,9	100	o. r.	o. r.	o. r.
91528	B 16-5	16	5,3	11,0	5,8	1,2	20,0	3,9	100	o. r.	o. r.	o. r.
91529	B 16-6	16	6,5	11,0	5,8	1,2	20,0	3,8	100	o. r.	o. r.	o. r.
91530	B 16-8	16	8,4	14,0	5,8	1,2	22,0	4,2	100	o. r.	o. r.	o. r.
91531	B 16-10	16	10,5	18,0	5,8	1,2	24,0	4,9	100	o. r.	o. r.	o. r.
91532	B 25-6	25	6,5	12,0	7,5	1,5	25,0	7,1	50	o. r.	o. r.	o. r.
91533	B 25-8	25	8,4	16,0	7,5	1,5	25,0	7,6	50	o. r.	o. r.	o. r.
91534	B 25-10	25	10,5	18,0	7,5	1,5	26,0	7,4	100	o. r.	o. r.	o. r.
91535	B 35-8	35	8,4	16,0	9,0	1,6	26,0	9,7	50	o. r.	o. r.	o. r.
91536	B 35-10	35	10,5	18,0	9,0	1,6	27,0	9,9	50	o. r.	o. r.	o. r.
91537	B 35-12	35	13,0	22,0	9,0	1,6	31,0	11,0	50	o. r.	o. r.	o. r.
91538	B 50-8	50	8,4	18,0	11,0	1,8	34,0	7,9	50	o. r.	o. r.	o. r.
91539	B 50-10	50	10,5	18,0	11,0	1,8	34,0	16,7	50	o. r.	o. r.	o. r.
91540	B 50-12	50	13,0	22,0	11,0	1,8	36,0	17,7	50	o. r.	o. r.	o. r.
91541	B 70-10	70	10,5	22,0	13,0	2,0	38,0	25,2	25	o. r.	o. r.	o. r.
91542	B 70-12	70	13,0	22,0	13,0	2,0	38,0	21,8	25	o. r.	o. r.	o. r.
91543	B 70-16	70	17,0	28,0	13,0	2,0	42,0	25,6	25	o. r.	o. r.	o. r.
91544	B 95-10	95	10,5	24,0	15,0	2,5	42,0	40,0	25	o. r.	o. r.	o. r.
91545	B 95-12	95	13,0	24,0	15,0	2,5	42,0	35,7	25	o. r.	o. r.	o. r.
91546	B 95-16	95	17,0	28,0	15,0	2,5	44,0	40,0	25	o. r.	o. r.	o. r.
97765	B 120-10	120	10,5	24,0	17,0	3,0	44,0	56,0	25	o. r.	o. r.	o. r.
97766	B 120-12	120	13,0	24,0	17,0	3,0	44,0	54,0	25	o. r.	o. r.	o. r.

Dimensions and specifications may be changed without prior notice.

o. r. = on request

B Solderless terminals

Non insulated

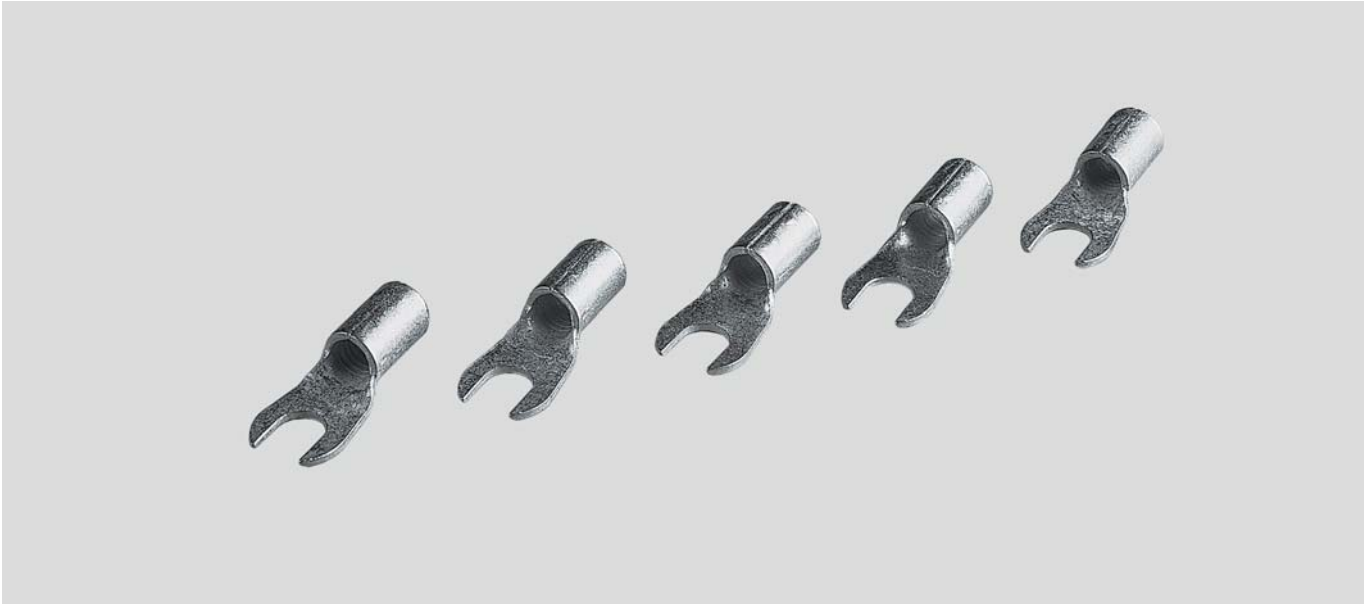

Solderless terminals type B

Non-insulated solderless terminals in fork design.

Material

Socket: Copper
Surface: tinned

Technical data

Temperature range: up to +125°C



Dimensions

- a Diameter of the boring
- d Inner diameter of the cable insertion
- b Flange width
- l Length till middle of the boring

Forked

Part no.	Type	Cross-section mm ²	a mm	b mm	d mm	t mm	l mm	Weight kg / 1000 items	Unit	Net EUR/100 items at a purchase of		
										up to 500	501 - 1000	1001 - 5000
91547	B 1-4F	0,5-1,5	4,3	7,0	1,6	0,8	12,0	0,7	100	o. r.	o. r.	o. r.
91548	B 1-5F	0,5-1,5	5,3	9,6	1,6	0,8	13,0	0,9	100	o. r.	o. r.	o. r.
91550	B 2,5-4F	1,5-2,5	4,3	7,0	2,3	0,8	12,0	0,8	100	o. r.	o. r.	o. r.
91551	B 2,5-5F	1,5-2,5	5,3	9,6	2,3	0,8	13,0	0,9	100	o. r.	o. r.	o. r.
91552	B 2,5-6F	1,5-2,5	6,5	12,0	2,3	0,8	13,0	1,1	100	o. r.	o. r.	o. r.
91553	B 6-4F	2,5-6,0	4,3	8,5	3,6	1,0	14,0	1,4	100	o. r.	o. r.	o. r.
91554	B 6-5F	2,5-6,0	5,3	9,0	3,6	1,0	14,0	1,6	100	o. r.	o. r.	o. r.
91555	B 6-6F	2,5-6,0	6,5	12,5	3,6	1,0	18,0	1,7	100	o. r.	o. r.	o. r.

Dimensions and specifications may be changed without prior notice.

o. r. = on request

B Solderless terminals

Non insulated



Solderless terminals B

Non-insulated squeeze snap-on connection in pin design.

Material

Copper
Surface: tinned

Technical data

Temperature range: up to +125°C

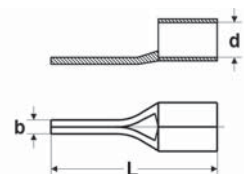

Dimensions

a Stick length
d Inner diameter of the cable insertion
b Stick width
L Total length

Pin form

Part no.	Type	Cross-section mm ²	a mm	b mm	d mm	t mm	l mm	Weight kg / 1000 items	Unit	Net EUR/100 items at a purchase of		
										up to 500	501 - 1000	1001 - 5000
91556	B 0,5P	0,5-1,5	10,0	1,9	-	-	17,0	0,6	100	o. r.	o. r.	o. r.
91557	B 2,5P	1,5-2,5	10,0	1,9	-	-	17,0	0,7	100	o. r.	o. r.	o. r.
91558	B 6P	2,5-6,0	11,0	2,7	-	-	20,0	1,6	100	o. r.	o. r.	o. r.
91559	B 10P	10	11,0	4,3	-	-	24,5	2,7	100	o. r.	o. r.	o. r.
91560	B 16P	16	15,0	5,8	-	-	29,5	3,9	100	o. r.	o. r.	o. r.
91378	B 25P	25	15,0	6,8	-	-	33,5	6,3	1	o. r.	o. r.	o. r.
91379	B 35P	35	20,0	8,0	-	-	40,5	11,7	1	o. r.	o. r.	o. r.
91380	B 50P	50	20,0	9,5	-	-	45,0	17,9	1	o. r.	o. r.	o. r.
91381	B 70P	70	23,0	11,0	-	-	55,0	28,2	1	o. r.	o. r.	o. r.
91377	B 95P	95	23,0	12,5	-	-	55,0	43,0	1	o. r.	o. r.	o. r.

Dimensions and specifications may be changed without prior notice.

o. r. = on request

HELU-S-RK-CU Copper tubular cable lug - straight

Not insulated



Tubular cable lug HELU-S-RK-CU

Uninsulated, straight tubular cable lugs in eye type design.

Material

Socket: Copper according to DIN EN 13600
Surface: tin plated

Note

Also available in angulated version (45° and 90°).
Compression instruction and instruction for assembly see chapter "Technical information".

Technical data

Temperature range: up to +120°C

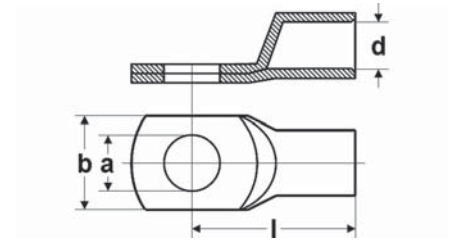

Abmessungen

- a Diameter of the boring
- d Inner diameter of the cable insertion
- b Flange width
- l Length till middle of the boring

Eye type

Part no.	Type	Cross-section mm ²	a mm	d mm	b mm	l mm	Code type	Weight kg / 1000 items	Unit	Net EUR/100 items at a purchase of		
										up to 100	101 - 500	501 - 1000
907303	HELU-S-RK-CU 0,75-3	0,75	3,2	1,4	6,5	12,5	-	0,7	100	o. r.	o. r.	o. r.
907304	HELU-S-RK-CU 0,75-4	0,75	4,3	1,4	8,5	14,0	-	0,8	100	o. r.	o. r.	o. r.
907305	HELU-S-RK-CU 0,75-5	0,75	5,3	1,4	10,0	15,0	-	1,0	100	o. r.	o. r.	o. r.
907306	HELU-S-RK-CU 1,5-3	1,5	3,2	1,9	6,5	14,0	-	1,2	100	o. r.	o. r.	o. r.
907307	HELU-S-RK-CU 1,5-4	1,5	4,3	1,9	8,5	15,0	-	1,4	100	o. r.	o. r.	o. r.
907309	HELU-S-RK-CU 1,5-6	1,5	6,4	1,9	11,0	18,0	-	1,7	100	o. r.	o. r.	o. r.
907311	HELU-S-RK-CU 2,5-5	2,5	5,3	2,4	10,0	16,0	-	1,8	100	o. r.	o. r.	o. r.
907312	HELU-S-RK-CU 2,5-6	2,5	6,4	2,4	11,0	18,0	-	1,9	100	o. r.	o. r.	o. r.
907313	HELU-S-RK-CU 2,5-8	2,5	8,4	2,4	13,0	20,0	-	2,2	100	o. r.	o. r.	o. r.
907314	HELU-S-RK-CU 4-4	4,0	4,3	3,0	8,5	17,0	-	2,2	100	o. r.	o. r.	o. r.
907315	HELU-S-RK-CU 4-5	4,0	5,3	3,0	10,0	18,0	-	2,4	100	o. r.	o. r.	o. r.
907316	HELU-S-RK-CU 4-6	4,0	6,3	3,0	11,0	20,0	-	2,6	100	o. r.	o. r.	o. r.
907317	HELU-S-RK-CU 4-8	4,0	8,4	3,0	14,0	22,0	-	3,0	100	o. r.	o. r.	o. r.

Dimensions and specifications may be changed without prior notice.

o. r. = on request

HELU-S-RK-CU-UL Tubular cable lug - straight



Not insulated



Tubular cable lug HELU-S-RK-CU-UL

Uninsulated, straight tubular cable lugs in eye type design.

Material

Socket: Copper according to DIN EN 13600
Surface: tin plated

Note

Also available in angulated version (45° and 90°).

Compression instruction and instruction for assembly see chapter "Technical information".

Technical data

Temperature range: up to +120°C

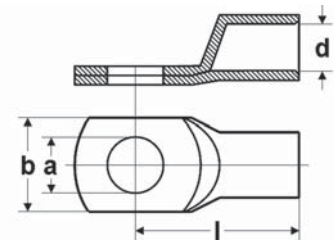

Abmessungen

- a Diameter of the boring
- d Inner diameter of the cable insertion
- b Flange width
- l Length till middle of the boring

Eye type

Part no.	Type	Cross-section mm ²	a mm	d mm	b mm	l mm	Code type	Weight kg / 1000 items	Unit	Net EUR/100 items at a purchase of		
										up to 100	101 - 500	501 - 1000
907318	HELU-S-RK-CU-UL 6-4	6,0	4,3	3,5	10,0	19,0	-	4,6	100	o. r.	o. r.	o. r.
907319	HELU-S-RK-CU-UL 6-5	6,0	5,3	3,5	10,0	20,0	-	4,7	100	o. r.	o. r.	o. r.
907320	HELU-S-RK-CU-UL 6-6	6,0	6,4	3,5	11,0	21,5	-	5,4	100	o. r.	o. r.	o. r.
907321	HELU-S-RK-CU-UL 6-8	6,0	8,4	3,5	15,0	24,0	-	5,9	100	o. r.	o. r.	o. r.
907322	HELU-S-RK-CU-UL 6-10	6,0	10,5	3,5	18,0	26,0	-	6,4	100	o. r.	o. r.	o. r.
907323	HELU-S-RK-CU-UL 6-12	6,0	13,0	3,5	19,0	27,5	-	6,4	100	o. r.	o. r.	o. r.
907324	HELU-S-RK-CU-UL 10-4	10,0	4,3	4,5	12,0	20,0	-	4,3	100	o. r.	o. r.	o. r.
907325	HELU-S-RK-CU-UL 10-5	10,0	5,3	4,5	12,0	21,0	-	4,8	100	o. r.	o. r.	o. r.
907326	HELU-S-RK-CU-UL 10-6	10,0	6,4	4,5	12,0	22,5	-	5,1	100	o. r.	o. r.	o. r.
907327	HELU-S-RK-CU-UL 10-8	10,0	8,4	4,5	15,0	25,0	-	5,8	100	o. r.	o. r.	o. r.
907328	HELU-S-RK-CU-UL 10-10	10,0	10,5	4,4	18,0	27,0	-	6,3	100	o. r.	o. r.	o. r.
907329	HELU-S-RK-CU-UL 10-12	10,0	13,0	4,5	20,0	28,5	-	6,3	100	o. r.	o. r.	o. r.
907330	HELU-S-RK-CU-UL 16-4	16,0	4,3	5,5	12,0	24,0	-	8,2	100	o. r.	o. r.	o. r.
907331	HELU-S-RK-CU-UL 16-5	16,0	5,3	5,5	12,0	25,0	-	8,9	100	o. r.	o. r.	o. r.
907332	HELU-S-RK-CU-UL 16-6	16,0	6,4	5,5	12,0	26,5	-	9,6	100	o. r.	o. r.	o. r.
907333	HELU-S-RK-CU-UL 16-8	16,0	8,4	5,5	15,0	29,0	-	10,3	100	o. r.	o. r.	o. r.
907334	HELU-S-RK-CU-UL 16-10	16,0	10,5	5,5	18,0	31,0	-	11,0	100	o. r.	o. r.	o. r.
907335	HELU-S-RK-CU-UL 16-12	16,0	13,0	5,5	19,0	32,0	-	10,8	100	o. r.	o. r.	o. r.
907336	HELU-S-RK-CU-UL 25-5	25,0	5,3	7,0	15,0	33,5	-	13,5	100	o. r.	o. r.	o. r.
907337	HELU-S-RK-CU-UL 25-6	25,0	6,4	7,0	15,0	31,5	-	13,1	100	o. r.	o. r.	o. r.
907338	HELU-S-RK-CU-UL 25-8	25,0	8,4	7,0	16,0	33,0	-	12,9	100	o. r.	o. r.	o. r.
907339	HELU-S-RK-CU-UL 25-10	25,0	10,5	7,0	18,0	34,5	-	14,6	100	o. r.	o. r.	o. r.
907340	HELU-S-RK-CU-UL 25-12	25,0	13,0	7,0	20,0	36,0	-	15,5	100	o. r.	o. r.	o. r.
907341	HELU-S-RK-CU-UL 25-14	25,0	15,0	7,0	22,0	39,0	-	16,6	100	o. r.	o. r.	o. r.
907342	HELU-S-RK-CU-UL 25-16	25,0	17,0	7,0	24,0	42,0	-	17,3	100	o. r.	o. r.	o. r.
907343	HELU-S-RK-CU-UL 35-6	35,0	6,4	8,5	17,0	33,0	-	20,7	100	o. r.	o. r.	o. r.
907344	HELU-S-RK-CU-UL 35-8	35,0	8,4	8,5	17,0	34,0	-	21,8	100	o. r.	o. r.	o. r.
907345	HELU-S-RK-CU-UL 35-10	35,0	10,5	8,5	20,0	36,5	-	21,9	100	o. r.	o. r.	o. r.
907346	HELU-S-RK-CU-UL 35-12	35,0	13,0	8,5	22,0	37,5	-	23,3	100	o. r.	o. r.	o. r.
907347	HELU-S-RK-CU-UL 35-14	35,0	15,0	8,5	23,0	40,0	-	24,4	100	o. r.	o. r.	o. r.

Continuation ►

HELU-S-RK-CU-UL Tubular cable lug - straight



Not insulated

Eye type

Part no.	Type	Cross-section mm ²	a mm	d mm	b mm	l mm	Code type	Weight kg / 1000 items	Unit	Net EUR/100 items at a purchase of		
										up to 100	101 - 500	501 - 1000
907348	HELU-S-RK-CU-UL 35-16	35,0	17,0	8,5	28,0	44,0	-	26,0	100	o. r.	o. r.	o. r.
907349	HELU-S-RK-CU-UL 50-6	50,0	6,4	10,0	20,0	37,0	-	30,1	100	o. r.	o. r.	o. r.
907350	HELU-S-RK-CU-UL 50-8	50,0	8,4	10,0	20,0	39,0	-	30,4	100	o. r.	o. r.	o. r.
907351	HELU-S-RK-CU-UL 50-10	50,0	10,5	10,0	20,0	40,5	-	31,3	100	o. r.	o. r.	o. r.
907352	HELU-S-RK-CU-UL 50-12	50,0	13,0	10,0	23,0	42,0	-	31,3	100	o. r.	o. r.	o. r.
907353	HELU-S-RK-CU-UL 50-14	50,0	15,0	10,0	23,0	44,0	-	35,1	100	o. r.	o. r.	o. r.
907354	HELU-S-RK-CU-UL 50-16	50,0	17,0	10,0	27,0	46,0	-	35,5	100	o. r.	o. r.	o. r.
907355	HELU-S-RK-CU-UL 50-20	50,0	21,0	10,0	30,5	52,5	-	38,9	100	o. r.	o. r.	o. r.
907356	HELU-S-RK-CU-UL 70-6	70,0	6,4	12,0	24,0	40,5	-	41,1	25	o. r.	o. r.	o. r.
907357	HELU-S-RK-CU-UL 70-8	70,0	8,4	12,0	24,0	42,5	-	44,6	25	o. r.	o. r.	o. r.
907358	HELU-S-RK-CU-UL 70-10	70,0	10,5	12,0	24,0	43,5	-	46,4	25	o. r.	o. r.	o. r.
907359	HELU-S-RK-CU-UL 70-12	70,0	13,0	12,0	24,0	45,0	-	47,3	25	o. r.	o. r.	o. r.
907360	HELU-S-RK-CU-UL 70-14	70,0	15,0	12,0	25,0	46,0	-	49,1	25	o. r.	o. r.	o. r.
907361	HELU-S-RK-CU-UL 70-16	70,0	17,0	12,0	28,0	48,5	-	49,6	25	o. r.	o. r.	o. r.
907362	HELU-S-RK-CU-UL 70-20	70,0	21,0	12,0	29,0	52,0	-	52,9	25	o. r.	o. r.	o. r.
907363	HELU-S-RK-CU-UL 95-6	95,0	6,4	13,5	26,0	43,0	-	49,5	25	o. r.	o. r.	o. r.
907364	HELU-S-RK-CU-UL 95-8	95,0	8,4	13,5	26,0	46,0	-	53,6	25	o. r.	o. r.	o. r.
907365	HELU-S-RK-CU-UL 95-10	95,0	10,5	13,5	26,0	47,0	-	55,1	25	o. r.	o. r.	o. r.
907366	HELU-S-RK-CU-UL 95-12	95,0	13,0	13,5	26,0	48,0	-	55,1	25	o. r.	o. r.	o. r.
907367	HELU-S-RK-CU-UL 95-14	95,0	15,0	13,5	26,0	51,5	-	58,9	25	o. r.	o. r.	o. r.
907368	HELU-S-RK-CU-UL 95-16	95,0	17,0	13,5	28,0	51,0	-	58,5	25	o. r.	o. r.	o. r.
907369	HELU-S-RK-CU-UL 95-20	95,0	21,0	13,5	30,0	55,0	-	61,3	25	o. r.	o. r.	o. r.
907370	HELU-S-RK-CU-UL 120-8	120,0	8,4	15,0	29,0	49,5	-	68,8	25	o. r.	o. r.	o. r.
907371	HELU-S-RK-CU-UL 120-10	120,0	10,5	15,0	29,0	52,0	-	79,9	25	o. r.	o. r.	o. r.
907372	HELU-S-RK-CU-UL 120-12	120,0	13,0	15,0	29,0	51,5	-	78,4	25	o. r.	o. r.	o. r.
907373	HELU-S-RK-CU-UL 120-14	120,0	15,0	15,0	30,0	53,0	-	78,6	25	o. r.	o. r.	o. r.
907374	HELU-S-RK-CU-UL 120-16	120,0	17,0	15,0	30,0	55,0	-	80,7	25	o. r.	o. r.	o. r.
907375	HELU-S-RK-CU-UL 120-20	120,0	21,0	15,0	35,0	60,0	-	89,0	25	o. r.	o. r.	o. r.
907376	HELU-S-RK-CU-UL 150-8	150,0	8,4	16,8	31,0	55,5	-	78,9	25	o. r.	o. r.	o. r.
907377	HELU-S-RK-CU-UL 150-10	150,0	10,5	16,8	31,0	56,5	-	83,7	25	o. r.	o. r.	o. r.
907378	HELU-S-RK-CU-UL 150-12	150,0	13,0	16,8	31,0	56,0	-	80,7	25	o. r.	o. r.	o. r.
907379	HELU-S-RK-CU-UL 150-14	150,0	15,0	16,8	31,0	57,0	-	83,0	25	o. r.	o. r.	o. r.
907380	HELU-S-RK-CU-UL 150-16	150,0	17,0	16,8	31,0	58,0	-	83,6	25	o. r.	o. r.	o. r.
907381	HELU-S-RK-CU-UL 150-20	150,0	21,0	16,8	35,0	63,0	-	87,5	25	o. r.	o. r.	o. r.
907382	HELU-S-RK-CU-UL 185-8	185,0	8,4	19,0	35,0	58,0	-	103,7	25	o. r.	o. r.	o. r.
907383	HELU-S-RK-CU-UL 185-10	185,0	10,5	19,0	35,0	59,0	-	106,1	25	o. r.	o. r.	o. r.
907384	HELU-S-RK-CU-UL 185-12	185,0	13,0	19,0	35,0	58,5	-	106,0	25	o. r.	o. r.	o. r.
907385	HELU-S-RK-CU-UL 185-14	185,0	15,0	19,0	35,0	61,0	-	107,2	25	o. r.	o. r.	o. r.
907386	HELU-S-RK-CU-UL 185-16	185,0	17,0	19,0	35,0	63,0	-	108,6	25	o. r.	o. r.	o. r.
907387	HELU-S-RK-CU-UL 185-20	185,0	21,0	19,0	35,0	66,0	-	113,3	25	o. r.	o. r.	o. r.
907388	HELU-S-RK-CU-UL 240-8	240,0	8,4	21,0	38,0	67,0	-	124,0	25	o. r.	o. r.	o. r.
907389	HELU-S-RK-CU-UL 240-10	240,0	10,5	21,0	38,0	67,0	-	129,7	25	o. r.	o. r.	o. r.
907390	HELU-S-RK-CU-UL 240-12	240,0	13,0	21,0	38,0	67,0	-	130,2	25	o. r.	o. r.	o. r.
907391	HELU-S-RK-CU-UL 240-14	240,0	15,0	21,0	38,0	69,0	-	133,6	25	o. r.	o. r.	o. r.
907392	HELU-S-RK-CU-UL 240-16	240,0	17,0	21,0	38,0	69,5	-	135,6	20	o. r.	o. r.	o. r.
907393	HELU-S-RK-CU-UL 240-20	240,0	21,0	21,0	38,0	71,0	-	138,0	25	o. r.	o. r.	o. r.
907394	HELU-S-RK-CU-UL 300-10	300,0	10,5	24,0	44,0	79,5	-	204,5	20	o. r.	o. r.	o. r.
907395	HELU-S-RK-CU-UL 300-12	300,0	13,0	24,0	44,0	82,0	-	211,8	20	o. r.	o. r.	o. r.
907396	HELU-S-RK-CU-UL 300-14	300,0	15,0	24,0	44,0	84,0	-	221,9	20	o. r.	o. r.	o. r.
907397	HELU-S-RK-CU-UL 300-16	300,0	17,0	24,0	44,0	85,0	-	219,4	20	o. r.	o. r.	o. r.
907398	HELU-S-RK-CU-UL 300-20	300,0	21,0	24,0	44,0	85,0	-	224,0	20	o. r.	o. r.	o. r.
907399	HELU-S-RK-CU-UL 400-10	400,0	10,5	27,5	49,0	92,0	-	279,0	15	o. r.	o. r.	o. r.
907400	HELU-S-RK-CU-UL 400-12	400,0	13,0	27,5	49,0	92,0	-	278,5	15	o. r.	o. r.	o. r.
907401	HELU-S-RK-CU-UL 400-16	400,0	17,0	27,5	49,0	92,0	-	276,5	15	o. r.	o. r.	o. r.
907402	HELU-S-RK-CU-UL 400-20	400,0	21,0	27,5	49,0	92,0	-	266,1	15	o. r.	o. r.	o. r.
907403	HELU-S-RK-CU-UL 500-12	500,0	13,0	31,0	55,5	113,0	-	493,8	5	o. r.	o. r.	o. r.
907404	HELU-S-RK-CU-UL 500-16	500,0	17,0	31,0	55,5	113,0	-	493,8	5	o. r.	o. r.	o. r.
907405	HELU-S-RK-CU-UL 500-20	500,0	21,0	31,0	55,5	113,0	-	485,6	5	o. r.	o. r.	o. r.
907406	HELU-S-RK-CU-UL 630-16	630,0	17,0	34,0	60,0	115,0	-	513,5	5	o. r.	o. r.	o. r.
907407	HELU-S-RK-CU-UL 630-20	630,0	21,0	34,0	60,0	115,0	-	506,0	5	o. r.	o. r.	o. r.

Dimensions and specifications may be changed without prior notice.

o. r. = on request

HELU-S-RK-45-CU-UL Copper tubular cable lug - 45° angled



Tubular cable lug angled HELU-S-RK-45-CU-UL

Non-insulated tubular cable lugs in eye type design, 45° angled.

Material

Socket: Copper according to DIN EN 13600
Surface: tin plated

Note

Compression instruction and instruction for assembly see chapter "Technical information".

Technical data

Temperature range: up to +120°C

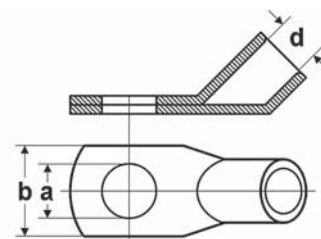

Dimensions

- a Diameter of the boring
- d Inner diameter of the cable insertion
- b Flange width

Eye type

Part no.	Type	Cross-section mm ²	a mm	d mm	b mm	Weight kg / 1000 items	Unit	Net EUR/100 items at a purchase of		
45°								up to 100	101 - 500	501 - 1000
907597	HELU-S-RK-45-CU-UL 10-5	10,0	5,3	4,5	12,0	5,5	100	o. r.	o. r.	o. r.
907598	HELU-S-RK-45-CU-UL 10-6	10,0	6,4	4,5	12,0	5,8	100	o. r.	o. r.	o. r.
907599	HELU-S-RK-45-CU-UL 10-8	10,0	8,4	4,5	15,0	6,5	100	o. r.	o. r.	o. r.
907600	HELU-S-RK-45-CU-UL 10-10	10,0	10,5	4,5	18,0	6,6	100	o. r.	o. r.	o. r.
907601	HELU-S-RK-45-CU-UL 16-5	16,0	5,3	5,5	12,0	9,5	100	o. r.	o. r.	o. r.
907467	HELU-S-RK-45-CU-UL 16-6	16,0	6,4	5,5	12,0	10,2	100	o. r.	o. r.	o. r.
907468	HELU-S-RK-45-CU-UL 16-8	16,0	8,4	5,5	15,0	11,7	100	o. r.	o. r.	o. r.
907469	HELU-S-RK-45-CU-UL 16-10	16,0	10,5	5,5	18,0	11,7	100	o. r.	o. r.	o. r.
907470	HELU-S-RK-45-CU-UL 25-6	25,0	6,4	7,0	15,0	13,9	100	o. r.	o. r.	o. r.
907471	HELU-S-RK-45-CU-UL 25-8	25,0	8,4	7,0	16,0	15,1	100	o. r.	o. r.	o. r.
907472	HELU-S-RK-45-CU-UL 25-10	25,0	10,5	7,0	18,0	16,6	100	o. r.	o. r.	o. r.
907473	HELU-S-RK-45-CU-UL 25-12	25,0	13,0	7,0	20,0	17,0	100	o. r.	o. r.	o. r.
907474	HELU-S-RK-45-CU-UL 35-6	35,0	6,4	8,5	17,0	21,7	50	o. r.	o. r.	o. r.
907475	HELU-S-RK-45-CU-UL 35-8	35,0	8,4	8,5	17,0	22,3	50	o. r.	o. r.	o. r.
907476	HELU-S-RK-45-CU-UL 35-10	35,0	10,5	8,5	20,0	23,4	50	o. r.	o. r.	o. r.
907477	HELU-S-RK-45-CU-UL 35-12	35,0	13,0	8,5	22,0	24,0	50	o. r.	o. r.	o. r.
907478	HELU-S-RK-45-CU-UL 50-6	50,0	6,4	10,0	20,0	29,4	50	o. r.	o. r.	o. r.
907479	HELU-S-RK-45-CU-UL 50-8	50,0	8,4	10,0	20,0	33,4	50	o. r.	o. r.	o. r.
907480	HELU-S-RK-45-CU-UL 50-10	50,0	10,5	10,0	20,0	36,5	50	o. r.	o. r.	o. r.
907481	HELU-S-RK-45-CU-UL 50-12	50,0	13,0	10,0	23,0	36,5	50	o. r.	o. r.	o. r.
907482	HELU-S-RK-45-CU-UL 70-8	70,0	8,4	12,0	24,0	49,0	25	o. r.	o. r.	o. r.
907483	HELU-S-RK-45-CU-UL 70-10	70,0	10,5	12,0	24,0	52,3	25	o. r.	o. r.	o. r.
907484	HELU-S-RK-45-CU-UL 70-12	70,0	13,0	12,0	24,0	53,4	25	o. r.	o. r.	o. r.
907485	HELU-S-RK-45-CU-UL 95-8	95,0	8,4	13,5	26,0	61,8	25	o. r.	o. r.	o. r.
907486	HELU-S-RK-45-CU-UL 95-10	95,0	10,5	13,5	26,0	62,0	25	o. r.	o. r.	o. r.
907487	HELU-S-RK-45-CU-UL 95-12	95,0	13,0	13,5	26,0	62,0	25	o. r.	o. r.	o. r.
907488	HELU-S-RK-45-CU-UL 95-16	95,0	17,0	13,5	28,0	68,0	25	o. r.	o. r.	o. r.
907489	HELU-S-RK-45-CU-UL 120-8	120,0	8,4	15,0	29,0	78,0	25	o. r.	o. r.	o. r.
907490	HELU-S-RK-45-CU-UL 120-10	120,0	10,5	15,0	29,0	89,0	25	o. r.	o. r.	o. r.
907491	HELU-S-RK-45-CU-UL 120-12	120,0	13,0	15,0	29,0	89,1	25	o. r.	o. r.	o. r.
907492	HELU-S-RK-45-CU-UL 120-16	120,0	17,0	15,0	30,0	93,1	25	o. r.	o. r.	o. r.
907493	HELU-S-RK-45-CU-UL 150-8	150,0	8,4	16,8	31,0	113,1	25	o. r.	o. r.	o. r.
907494	HELU-S-RK-45-CU-UL 150-10	150,0	10,5	16,8	31,0	98,0	25	o. r.	o. r.	o. r.
907495	HELU-S-RK-45-CU-UL 150-12	150,0	13,0	16,8	31,0	96,8	25	o. r.	o. r.	o. r.
907496	HELU-S-RK-45-CU-UL 150-16	150,0	17,0	16,8	31,0	101,2	25	o. r.	o. r.	o. r.
907497	HELU-S-RK-45-CU-UL 150-20	150,0	21,0	16,8	35,0	101,2	25	o. r.	o. r.	o. r.
907498	HELU-S-RK-45-CU-UL 185-10	185,0	10,5	19,0	35,0	123,5	20	o. r.	o. r.	o. r.
907499	HELU-S-RK-45-CU-UL 185-12	185,0	13,0	19,0	35,0	122,4	20	o. r.	o. r.	o. r.

Continuation ►

HELU-S-RK-45-CU-UL Copper tubular cable lug - 45° angled



Eye type

Part no. 45°	Type	Cross-section mm ²	a mm	d mm	b mm	Weight kg / 1000 items	Unit	Net EUR/100 items at a purchase of		
								up to 100	101 - 500	501 - 1000
907500	HELU-S-RK-45-CU-UL 185-16	185,0	17,0	19,0	35,0	128,4	20	o. r.	o. r.	o. r.
907501	HELU-S-RK-45-CU-UL 185-20	185,0	21,0	19,0	35,0	139,9	20	o. r.	o. r.	o. r.
907502	HELU-S-RK-45-CU-UL 240-12	240,0	13,0	21,0	38,0	154,6	15	o. r.	o. r.	o. r.
907503	HELU-S-RK-45-CU-UL 240-16	240,0	17,0	21,0	38,0	165,1	15	o. r.	o. r.	o. r.
907504	HELU-S-RK-45-CU-UL 240-20	240,0	21,0	21,0	38,0	170,4	15	o. r.	o. r.	o. r.
907505	HELU-S-RK-45-CU-UL 300-12	300,0	13,0	24,0	43,0	257,0	15	o. r.	o. r.	o. r.
907506	HELU-S-RK-45-CU-UL 300-16	300,0	17,0	24,0	43,0	256,8	15	o. r.	o. r.	o. r.
907507	HELU-S-RK-45-CU-UL 300-20	300,0	21,0	24,0	43,0	273,0	15	o. r.	o. r.	o. r.

Dimensions and specifications may be changed without prior notice.

o. r. = on request

HELU-S-RK-90-CU-UL Copper tubular cable lug - 90° angled



Tubular cable lug angled HELU-S-RK-90-CU-UL

Non-insulated tubular cable lugs in eye type design, 90° angled.

Material

Socket: Copper according to DIN EN 13600
Surface: tin plated

Technical data

Temperature range: up to +120°C

Note

Compression instruction and instruction for assembly see chapter "Technical information".

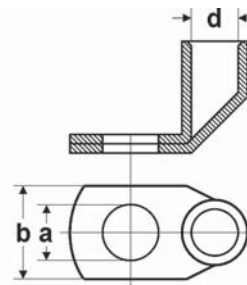

Dimensions

- a Diameter of boring
- d Inner diameter of the cable insertion
- b Flange width

Eye type

Part no.	Type	Cross-section mm ²	a mm	d mm	b mm	Weight kg / 1000 items	Unit	Net EUR/ 100 items at a purchase of		
90°								up to 100	101 - 500	501 - 1000
907508	HELU-S-RK-90-CU-UL 6-5	6,0	5,3	3,5	11,0	5,6	100	o. r.	o. r.	o. r.
907509	HELU-S-RK-90-CU-UL 6-6	6,0	6,4	3,5	11,0	6,2	100	o. r.	o. r.	o. r.
907510	HELU-S-RK-90-CU-UL 6-8	6,0	8,4	3,5	15,0	6,4	100	o. r.	o. r.	o. r.
907511	HELU-S-RK-90-CU-UL 6-10	6,0	10,5	3,5	18,0	6,8	100	o. r.	o. r.	o. r.
907512	HELU-S-RK-90-CU-UL 6-12	6,0	13,0	3,5	20,0	6,6	100	o. r.	o. r.	o. r.
907513	HELU-S-RK-90-CU-UL 10-5	10,0	5,3	4,5	12,0	5,4	100	o. r.	o. r.	o. r.
907514	HELU-S-RK-90-CU-UL 10-6	10,0	6,4	4,5	12,0	5,9	100	o. r.	o. r.	o. r.
907515	HELU-S-RK-90-CU-UL 10-8	10,0	8,4	4,5	15,0	6,7	100	o. r.	o. r.	o. r.
907516	HELU-S-RK-90-CU-UL 10-10	10,0	10,5	4,5	18,0	7,0	100	o. r.	o. r.	o. r.
907517	HELU-S-RK-90-CU-UL 10-12	10,0	13,0	4,5	20,0	7,0	100	o. r.	o. r.	o. r.
907518	HELU-S-RK-90-CU-UL 16-5	16,0	5,3	5,5	12,0	10,7	100	o. r.	o. r.	o. r.
907519	HELU-S-RK-90-CU-UL 16-6	16,0	6,4	5,5	12,0	11,5	100	o. r.	o. r.	o. r.
907520	HELU-S-RK-90-CU-UL 16-8	16,0	8,4	5,5	15,0	12,0	100	o. r.	o. r.	o. r.
907521	HELU-S-RK-90-CU-UL 16-10	16,0	10,5	5,5	18,0	12,3	100	o. r.	o. r.	o. r.
907522	HELU-S-RK-90-CU-UL 16-12	16,0	13,0	5,5	20,0	12,3	100	o. r.	o. r.	o. r.
907523	HELU-S-RK-90-CU-UL 25-6	25,0	6,4	7,0	15,0	13,5	100	o. r.	o. r.	o. r.
907524	HELU-S-RK-90-CU-UL 25-8	25,0	8,4	7,0	16,0	14,3	100	o. r.	o. r.	o. r.
907525	HELU-S-RK-90-CU-UL 25-10	25,0	10,5	7,0	18,0	15,7	100	o. r.	o. r.	o. r.
907526	HELU-S-RK-90-CU-UL 25-12	25,0	13,0	7,0	20,0	15,1	100	o. r.	o. r.	o. r.
907527	HELU-S-RK-90-CU-UL 35-6	35,0	6,4	8,5	17,0	21,0	100	o. r.	o. r.	o. r.
907528	HELU-S-RK-90-CU-UL 35-8	35,0	8,4	8,5	17,0	23,1	100	o. r.	o. r.	o. r.
907529	HELU-S-RK-90-CU-UL 35-10	35,0	10,5	8,5	20,0	23,6	100	o. r.	o. r.	o. r.
907530	HELU-S-RK-90-CU-UL 35-12	35,0	13,0	8,5	22,0	23,7	100	o. r.	o. r.	o. r.
907531	HELU-S-RK-90-CU-UL 35-16	35,0	17,0	8,5	28,0	24,8	100	o. r.	o. r.	o. r.
907532	HELU-S-RK-90-CU-UL 50-6	50,0	6,4	10,0	20,0	30,0	100	o. r.	o. r.	o. r.
907533	HELU-S-RK-90-CU-UL 50-8	50,0	8,4	10,0	20,0	32,2	100	o. r.	o. r.	o. r.
907534	HELU-S-RK-90-CU-UL 50-10	50,0	10,5	10,0	20,0	33,2	100	o. r.	o. r.	o. r.
907535	HELU-S-RK-90-CU-UL 50-12	50,0	13,0	10,0	23,0	32,8	100	o. r.	o. r.	o. r.
907536	HELU-S-RK-90-CU-UL 50-16	50,0	17,0	10,0	27,0	36,3	100	o. r.	o. r.	o. r.
907537	HELU-S-RK-90-CU-UL 50-20	50,0	21,0	10,0	30,0	38,9	100	o. r.	o. r.	o. r.
907538	HELU-S-RK-90-CU-UL 70-6	70,0	6,4	12,0	24,0	44,1	25	o. r.	o. r.	o. r.
907539	HELU-S-RK-90-CU-UL 70-8	70,0	8,4	12,0	24,0	48,6	25	o. r.	o. r.	o. r.
907540	HELU-S-RK-90-CU-UL 70-10	70,0	10,5	12,0	24,0	50,6	25	o. r.	o. r.	o. r.
907541	HELU-S-RK-90-CU-UL 70-12	70,0	13,0	12,0	24,0	49,4	25	o. r.	o. r.	o. r.
907542	HELU-S-RK-90-CU-UL 70-16	70,0	17,0	12,0	28,0	51,1	25	o. r.	o. r.	o. r.
907543	HELU-S-RK-90-CU-UL 70-20	70,0	21,0	12,0	29,0	52,6	25	o. r.	o. r.	o. r.

Continuation ►

HELU-S-RK-90-CU-UL Copper tubular cable lug - 90° angled



Eye type

Part no. 90°	Type	Cross-section mm ²	a mm	d mm	b mm	Weight kg / 1000 items	Unit	Net EUR/100 items at a purchase of		
								up to 100	101 - 500	501 - 1000
907544	HELU-S-RK-90-CU-UL 95-8	95,0	8,4	13,5	26,0	53,3	25	o. r.	o. r.	o. r.
907545	HELU-S-RK-90-CU-UL 95-10	95,0	10,5	13,5	26,0	55,9	25	o. r.	o. r.	o. r.
907546	HELU-S-RK-90-CU-UL 95-12	95,0	13,0	13,5	26,0	56,6	25	o. r.	o. r.	o. r.
907547	HELU-S-RK-90-CU-UL 95-16	95,0	17,0	13,5	28,0	60,0	25	o. r.	o. r.	o. r.
907548	HELU-S-RK-90-CU-UL 120-8	120,0	8,4	15,0	29,0	76,3	25	o. r.	o. r.	o. r.
907549	HELU-S-RK-90-CU-UL 120-10	120,0	10,5	15,0	29,0	80,7	25	o. r.	o. r.	o. r.
907550	HELU-S-RK-90-CU-UL 120-12	120,0	13,0	15,0	29,0	79,9	25	o. r.	o. r.	o. r.
907551	HELU-S-RK-90-CU-UL 120-16	120,0	17,0	15,0	30,0	84,6	25	o. r.	o. r.	o. r.
907552	HELU-S-RK-90-CU-UL 150-8	150,0	8,4	16,8	31,0	80,3	25	o. r.	o. r.	o. r.
907553	HELU-S-RK-90-CU-UL 150-10	150,0	10,5	16,8	31,0	80,7	25	o. r.	o. r.	o. r.
907554	HELU-S-RK-90-CU-UL 150-12	150,0	13,0	16,8	31,0	82,9	25	o. r.	o. r.	o. r.
907555	HELU-S-RK-90-CU-UL 150-16	150,0	17,0	16,8	31,0	85,0	25	o. r.	o. r.	o. r.
907556	HELU-S-RK-90-CU-UL 150-20	150,0	21,0	16,8	35,0	88,9	25	o. r.	o. r.	o. r.
907557	HELU-S-RK-90-CU-UL 185-10	185,0	10,5	19,0	35,0	114,1	25	o. r.	o. r.	o. r.
907558	HELU-S-RK-90-CU-UL 185-12	185,0	13,0	19,0	35,0	120,4	25	o. r.	o. r.	o. r.
907559	HELU-S-RK-90-CU-UL 185-16	185,0	17,0	19,0	35,0	124,8	25	o. r.	o. r.	o. r.
907560	HELU-S-RK-90-CU-UL 185-20	185,0	21,0	19,0	35,0	127,0	25	o. r.	o. r.	o. r.
907561	HELU-S-RK-90-CU-UL 240-10	240,0	10,5	21,0	38,0	133,2	25	o. r.	o. r.	o. r.
907562	HELU-S-RK-90-CU-UL 240-12	240,0	13,0	21,0	38,0	134,0	25	o. r.	o. r.	o. r.
907563	HELU-S-RK-90-CU-UL 240-16	240,0	17,0	21,0	38,0	137,6	25	o. r.	o. r.	o. r.
907564	HELU-S-RK-90-CU-UL 240-20	240,0	21,0	21,0	38,0	142,3	25	o. r.	o. r.	o. r.
907565	HELU-S-RK-90-CU-UL 300-12	300,0	13,0	24,0	43,0	199,2	20	o. r.	o. r.	o. r.
907566	HELU-S-RK-90-CU-UL 300-16	300,0	17,0	24,0	43,0	209,0	20	o. r.	o. r.	o. r.
907567	HELU-S-RK-90-CU-UL 300-20	300,0	21,0	24,0	43,0	218,1	20	o. r.	o. r.	o. r.

Dimensions and specifications may be changed without prior notice.

o. r. = on request

HELU-S-RK-S-CU-UL Tubular cable lug - straight - small flange



Not insulated



Tubular cable lug HELU-S-RK-S-CU-UL

Non-insulated tubular cable lugs in eye type design with small flange.
For screwing in switch cabinets with reduced connecting space.

Material

Socket: Copper
Surface: tinned

Note

Compression instruction and instruction for assembly see chapter "Technical information".

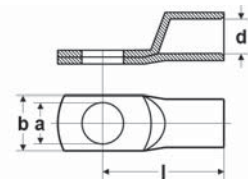

Dimensions

- a Diameter of the boring
- d Inner diameter of the cable insertion
- b Flange width
- l Length till middle of the boring

Eye type

Part no. straight	Type	Cross-section mm ²	a mm	d mm	b mm	Weight kg / 1000 items	Unit	Net EUR/ 100 items at a purchase of up to 100	101 - 500	501 - 1000
90910	HELU-S-RK-S-CU-UL 35-6	35,0	6,5	8,5	15,0	17,8	25	o. r.	o. r.	o. r.
90911	HELU-S-RK-S-CU-UL 50-6	50,0	6,5	10,0	15,0	29,5	25	o. r.	o. r.	o. r.
90912	HELU-S-RK-S-CU-UL 50-8	50,0	8,5	10,0	17,0	28,2	25	o. r.	o. r.	o. r.
90913	HELU-S-RK-S-CU-UL 50-10	50,0	10,5	10,0	19,0	30,8	25	o. r.	o. r.	o. r.
90914	HELU-S-RK-S-CU-UL 70-6	70,0	6,5	12,0	17,0	42,2	25	o. r.	o. r.	o. r.
90915	HELU-S-RK-S-CU-UL 70-8	70,0	8,5	12,0	17,0	41,0	25	o. r.	o. r.	o. r.
90916	HELU-S-RK-S-CU-UL 70-10	70,0	10,5	12,0	19,0	44,5	25	o. r.	o. r.	o. r.
90917	HELU-S-RK-S-CU-UL 70-12	70,0	13,0	12,0	19,0	42,2	25	o. r.	o. r.	o. r.
90918	HELU-S-RK-S-CU-UL 95-6	95,0	6,5	13,5	19,0	54,9	25	o. r.	o. r.	o. r.
90919	HELU-S-RK-S-CU-UL 95-8	95,0	8,5	13,5	19,0	54,6	25	o. r.	o. r.	o. r.
90920	HELU-S-RK-S-CU-UL 95-10	95,0	10,5	13,5	19,0	51,3	25	o. r.	o. r.	o. r.
90921	HELU-S-RK-S-CU-UL 95-12	95,0	13,0	13,5	19,0	51,5	25	o. r.	o. r.	o. r.
90922	HELU-S-RK-S-CU-UL 120-6	120,0	6,5	15,0	19,0	61,6	10	o. r.	o. r.	o. r.
90923	HELU-S-RK-S-CU-UL 120-8	120,0	8,5	15,0	19,0	59,4	10	o. r.	o. r.	o. r.
90924	HELU-S-RK-S-CU-UL 120-10	120,0	10,5	15,0	19,0	58,1	10	o. r.	o. r.	o. r.
90925	HELU-S-RK-S-CU-UL 120-12	120,0	13,0	15,0	19,0	59,2	10	o. r.	o. r.	o. r.
90926	HELU-S-RK-S-CU-UL 150-6	150,0	6,5	16,5	19,0	68,5	10	o. r.	o. r.	o. r.
90927	HELU-S-RK-S-CU-UL 150-8	150,0	8,5	16,5	19,0	68,0	10	o. r.	o. r.	o. r.
90928	HELU-S-RK-S-CU-UL 150-10	150,0	10,5	16,5	19,0	67,5	10	o. r.	o. r.	o. r.
90929	HELU-S-RK-S-CU-UL 150-12	150,0	13,0	16,5	19,0	71,5	10	o. r.	o. r.	o. r.
90930	HELU-S-RK-S-CU-UL 185-10	185,0	10,5	19,0	24,5	105,9	10	o. r.	o. r.	o. r.
90931	HELU-S-RK-S-CU-UL 185-12	185,0	13,0	19,0	31,0	110,9	10	o. r.	o. r.	o. r.
90932	HELU-S-RK-S-CU-UL 185-16	185,0	17,0	19,0	31,0	97,6	10	o. r.	o. r.	o. r.
90933	HELU-S-RK-S-CU-UL 240-10	240,0	10,5	21,0	31,0	127,0	5	o. r.	o. r.	o. r.
90934	HELU-S-RK-S-CU-UL 240-12	240,0	13,0	21,0	31,0	137,2	5	o. r.	o. r.	o. r.
90935	HELU-S-RK-S-CU-UL 240-16	240,0	17,0	21,0	31,0	132,8	5	o. r.	o. r.	o. r.

Dimensions and specifications may be changed without prior notice.

o. r. = on request

HELU-S-RK-F-CU Tubular cable lugs for fine stranded wires - straight

Not insulated



Tubular cable lug HELU-S-RK-F-CU

Uninsulated, straight tubular cable lugs in eye type design for fine stranded wires. The expanded sleeve facilitates cable inlet.

Material

Socket: Copper according to DIN EN 13600
Surface: tin plated

Technical data

Temperature range: up to +120°C

Note

Compression instruction and instruction for assembly see chapter "Technical information".

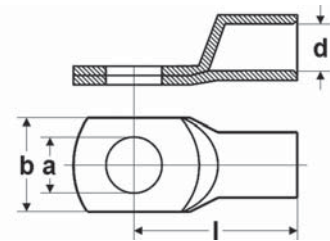

Dimensions

- a Diameter of the boring
- d Inner diameter of the cable insertion
- b Flange width
- l Length till middle of the boring

Eye type

Part no.	Type	Cross-section mm ²	a mm	d mm	b mm	l mm	Code type	Weight kg / 1000 items	Unit	Net EUR/100 items at a purchase of		
										up to 100	101 - 500	501 - 1000
907409	HELU-S-RK-F-CU 10-5	10,0	5,3	5,0	12,0	23,0	-	7,0	100	o. r.	o. r.	o. r.
907410	HELU-S-RK-F-CU 10-6	10,0	6,4	5,0	12,0	25,0	-	7,6	100	o. r.	o. r.	o. r.
907411	HELU-S-RK-F-CU 10-8	10,0	8,4	5,0	15,0	28,0	-	8,9	100	o. r.	o. r.	o. r.
907412	HELU-S-RK-F-CU 10-10	10,0	10,5	5,0	18,0	31,0	-	9,8	100	o. r.	o. r.	o. r.
907413	HELU-S-RK-F-CU 10-12	10,0	13,0	5,0	20,0	32,0	-	10,0	100	o. r.	o. r.	o. r.
907414	HELU-S-RK-F-CU 16-5	16,0	5,3	6,0	14,0	25,5	-	9,4	100	o. r.	o. r.	o. r.
907415	HELU-S-RK-F-CU 16-6,4	16,0	6,4	6,0	14,0	27,0	-	10,0	100	o. r.	o. r.	o. r.
907416	HELU-S-RK-F-CU 16-8	16,0	8,4	6,0	15,0	29,5	-	11,2	100	o. r.	o. r.	o. r.
907417	HELU-S-RK-F-CU 16-10	16,0	10,5	6,0	18,0	32,0	-	11,2	100	o. r.	o. r.	o. r.
907418	HELU-S-RK-F-CU 16-12	16,0	13,0	6,0	20,0	33,0	-	11,8	100	o. r.	o. r.	o. r.
907419	HELU-S-RK-F-CU 25-6	25,0	6,4	7,7	16,0	32,0	-	14,7	100	o. r.	o. r.	o. r.
907420	HELU-S-RK-F-CU 25-8	25,0	8,4	7,7	16,0	34,0	-	14,3	100	o. r.	o. r.	o. r.
907421	HELU-S-RK-F-CU 25-10	25,0	10,5	7,7	18,0	35,0	-	15,3	100	o. r.	o. r.	o. r.
907422	HELU-S-RK-F-CU 25-12	25,0	13,0	7,7	20,0	36,0	-	16,1	100	o. r.	o. r.	o. r.
907423	HELU-S-RK-F-CU 25-16	25,0	17,0	7,7	26,0	40,5	-	19,1	100	o. r.	o. r.	o. r.
907424	HELU-S-RK-F-CU 35-6	35,0	6,4	9,2	18,0	36,0	-	20,7	100	o. r.	o. r.	o. r.
907425	HELU-S-RK-F-CU 35-8	35,0	8,4	9,2	18,0	36,0	-	20,7	100	o. r.	o. r.	o. r.
907426	HELU-S-RK-F-CU 35-10	35,0	10,5	9,2	18,0	38,0	-	21,4	100	o. r.	o. r.	o. r.
907427	HELU-S-RK-F-CU 35-12	35,0	13,0	9,2	23,0	40,0	-	22,2	100	o. r.	o. r.	o. r.
907428	HELU-S-RK-F-CU 35-16	35,0	17,0	9,2	26,0	45,0	-	24,2	100	o. r.	o. r.	o. r.
907429	HELU-S-RK-F-CU 50-6	50,0	6,4	11,2	22,0	42,0	-	32,5	100	o. r.	o. r.	o. r.
907430	HELU-S-RK-F-CU 50-8	50,0	8,4	11,2	22,0	42,0	-	32,2	100	o. r.	o. r.	o. r.
907431	HELU-S-RK-F-CU 50-10	50,0	10,5	11,2	22,0	43,0	-	33,3	100	o. r.	o. r.	o. r.
907432	HELU-S-RK-F-CU 50-12	50,0	13,0	11,2	23,0	44,0	-	33,9	100	o. r.	o. r.	o. r.
907433	HELU-S-RK-F-CU 50-14	50,0	15,0	11,2	25,0	45,5	-	36,0	100	o. r.	o. r.	o. r.
907434	HELU-S-RK-F-CU 50-16	50,0	17,0	11,2	28,0	48,5	-	36,5	100	o. r.	o. r.	o. r.

Continuation ▶

HELU-S-RK-F-CU Tubular cable lugs for fine stranded wires - straight

Not insulated

Eye type

Part no.	Type	Cross-section mm ²	a mm	d mm	b mm	l mm	Code type	Weight kg / 1000 items	Unit	Net EUR/100 items at a purchase of		
										up to 100	101 - 500	501 - 1000
907435	HELU-S-RK-F-CU 70-6	70,0	6,4	13,5	25,0	46,0	-	44,3	50	o. r.	o. r.	o. r.
907436	HELU-S-RK-F-CU 70-8	70,0	8,4	13,5	25,0	45,5	-	48,0	50	o. r.	o. r.	o. r.
907437	HELU-S-RK-F-CU 70-10	70,0	10,5	13,5	25,0	47,0	-	48,4	50	o. r.	o. r.	o. r.
907438	HELU-S-RK-F-CU 70-12	70,0	13,0	13,5	26,0	47,0	-	48,4	50	o. r.	o. r.	o. r.
907439	HELU-S-RK-F-CU 70-16	70,0	17,0	13,5	28,0	50,0	-	50,5	50	o. r.	o. r.	o. r.
907440	HELU-S-RK-F-CU 70-20	70,0	21,0	13,5	31,0	54,5	-	55,2	50	o. r.	o. r.	o. r.
907441	HELU-S-RK-F-CU 95-6	95,0	6,4	15,5	29,0	50,5	-	65,0	50	o. r.	o. r.	o. r.
907442	HELU-S-RK-F-CU 95-8	95,0	8,4	15,5	29,0	50,5	-	66,2	50	o. r.	o. r.	o. r.
907443	HELU-S-RK-F-CU 95-10	95,0	10,5	15,5	29,0	53,0	-	71,5	50	o. r.	o. r.	o. r.
907444	HELU-S-RK-F-CU 95-12	95,0	13,0	15,5	29,0	52,5	-	71,1	50	o. r.	o. r.	o. r.
907445	HELU-S-RK-F-CU 95-16	95,0	17,0	15,5	29,0	55,0	-	71,9	50	o. r.	o. r.	o. r.
907446	HELU-S-RK-F-CU 95-20	95,0	21,0	15,5	35,0	60,0	-	76,1	50	o. r.	o. r.	o. r.
907447	HELU-S-RK-F-CU 120-10	120,0	10,5	16,8	31,0	56,5	-	80,7	50	o. r.	o. r.	o. r.
907448	HELU-S-RK-F-CU 120-12	120,0	13,0	16,8	31,0	56,0	-	80,7	50	o. r.	o. r.	o. r.
907449	HELU-S-RK-F-CU 120-16	120,0	17,0	16,8	31,0	58,0	-	83,6	50	o. r.	o. r.	o. r.
907450	HELU-S-RK-F-CU 120-20	120,0	21,0	16,8	35,0	63,0	-	87,5	50	o. r.	o. r.	o. r.
907451	HELU-S-RK-F-CU 150-10	150,0	10,5	19,0	35,0	59,0	-	104,0	25	o. r.	o. r.	o. r.
907452	HELU-S-RK-F-CU 150-12	150,0	13,0	19,0	35,0	58,5	-	106,2	25	o. r.	o. r.	o. r.
907453	HELU-S-RK-F-CU 150-16	150,0	17,0	19,0	35,0	63,0	-	111,9	25	o. r.	o. r.	o. r.
907454	HELU-S-RK-F-CU 150-20	150,0	21,0	19,0	35,0	66,0	-	116,1	25	o. r.	o. r.	o. r.
907455	HELU-S-RK-F-CU 185-10	185,0	10,5	21,0	38,0	67,0	-	130,3	25	o. r.	o. r.	o. r.
907456	HELU-S-RK-F-CU 185-13	185,0	13,0	21,0	38,0	67,0	-	121,5	25	o. r.	o. r.	o. r.
907457	HELU-S-RK-F-CU 185-16	185,0	17,0	21,0	38,0	69,5	-	128,8	25	o. r.	o. r.	o. r.
907458	HELU-S-RK-F-CU 185-20	185,0	21,0	21,0	38,0	71,0	-	139,5	25	o. r.	o. r.	o. r.
907459	HELU-S-RK-F-CU 240-12	240,0	13,0	24,0	44,0	82,0	-	214,0	20	o. r.	o. r.	o. r.
907460	HELU-S-RK-F-CU 240-16	240,0	17,0	24,0	44,0	85,0	-	219,4	20	o. r.	o. r.	o. r.
907461	HELU-S-RK-F-CU 240-20	240,0	21,0	24,0	44,0	85,0	-	222,0	20	o. r.	o. r.	o. r.

Dimensions and specifications may be changed without prior notice.

o. r. = on request

HELU-S-PK-CU Tubular compression cable lugs - straight

Not insulated



Tubular cable lugs HELU-S-PK-CU

Non-insulated tubular cable lugs in eye type design for conductor arrangement RM. Tube dimensions to DIN 46235.

Material

Socket: Copper according to DIN EN 13600
Surface: tin plated or optionally uncoated

Note

Code type indicates the required hexagonal clamping insert.
Compression instruction and instruction for assembly see chapter "Technical information".

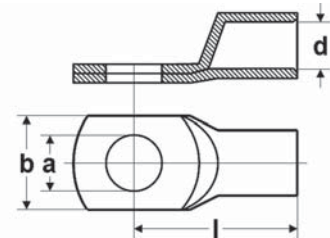

Diameter

- a Diameter of the boring
- d Inner diameter of the canle insertion
- b Flange width
- l Length till middle of the boring

Eye type

Part no.	Type	Cross-section mm ²	a mm	d mm	b mm	l mm	Code type	Weight kg / 1000 items	Unit	Net EUR/100 items at a purchase of		
										up to 100	101 - 500	501 - 1000
907679	HELU-S-PK-CU 6-8	6,0	8,4	3,5	13,0	26,0	5	3,1	100	o. r.	o. r.	o. r.
907682	HELU-S-PK-CU 10-8	10,0	8,4	4,4	13,0	28,0	6	3,8	100	o. r.	o. r.	o. r.
907683	HELU-S-PK-CU 10-10	10,0	10,5	4,4	15,0	29,0	6	3,8	100	o. r.	o. r.	o. r.
907684	HELU-S-PK-CU 16-5	16,0	5,3	5,5	13,0	36,0	8	12,2	100	o. r.	o. r.	o. r.
907688	HELU-S-PK-CU 16-12	16,0	13,0	5,5	19,0	40,0	8	13,5	100	o. r.	o. r.	o. r.
907693	HELU-S-PK-CU 25-16	25,0	17,0	7,0	22,0	45,0	10	19,9	100	o. r.	o. r.	o. r.
907694	HELU-S-PK-CU 35-6	35,0	6,4	8,2	17,5	42,5	12	31,2	100	o. r.	o. r.	o. r.
907698	HELU-S-PK-CU 35-16	35,0	17,0	8,2	28,0	47,0	12	31,4	100	o. r.	o. r.	o. r.
907699	HELU-S-PK-CU 35-20	35,0	21,0	8,2	30,0	53,0	12	37,3	100	o. r.	o. r.	o. r.
907700	HELU-S-PK-CU 50-6	50,0	6,4	9,8	20,0	52,0	14	46,7	100	o. r.	o. r.	o. r.
907704	HELU-S-PK-CU 50-14	50,0	15,0	9,8	26,0	53,5	14	49,4	100	o. r.	o. r.	o. r.
907706	HELU-S-PK-CU 50-20	50,0	21,0	9,8	30,0	55,6	14	55,6	100	o. r.	o. r.	o. r.
907710	HELU-S-PK-CU 70-14	70,0	15,0	11,3	24,0	55,5	16	60,0	50	o. r.	o. r.	o. r.
907712	HELU-S-PK-CU 70-20	70,0	21,0	11,3	31,0	61,0	16	69,9	50	o. r.	o. r.	o. r.
907713	HELU-S-PK-CU 95-8	95,0	8,4	13,5	28,0	65,0	18	93,6	50	o. r.	o. r.	o. r.
907714	HELU-S-PK-CU 95-14	95,0	15,0	13,5	28,0	65,5	18	94,3	50	o. r.	o. r.	o. r.
907717	HELU-S-PK-CU 120-8	120,0	8,4	15,5	31,0	70,0	20	113,5	50	o. r.	o. r.	o. r.
907718	HELU-S-PK-CU 120-14	120,0	15,0	15,5	31,0	70,0	20	114,1	50	o. r.	o. r.	o. r.
907721	HELU-S-PK-CU 150-8	150,0	8,4	17,0	34,0	79,0	22	164,0	25	o. r.	o. r.	o. r.
907723	HELU-S-PK-CU 150-14	150,0	15,0	17,0	34,0	78,0	22	164,9	25	o. r.	o. r.	o. r.
907725	HELU-S-PK-CU 185-8	185,0	8,4	19,0	37,0	83,0	25	185,0	25	o. r.	o. r.	o. r.
907727	HELU-S-PK-CU 185-14	185,0	15,0	19,0	37,0	82,0	25	189,6	25	o. r.	o. r.	o. r.
907729	HELU-S-PK-CU 240-10	240,0	10,5	21,5	42,0	92,0	28	271,0	20	o. r.	o. r.	o. r.
907730	HELU-S-PK-CU 240-14	240,0	15,0	21,5	42,5	92,0	28	267,3	20	o. r.	o. r.	o. r.
907732	HELU-S-PK-CU 300-10	300,0	10,5	24,5	48,5	104,0	32	348,0	10	o. r.	o. r.	o. r.
907733	HELU-S-PK-CU 300-12	300,0	13,0	24,5	48,5	104,0	32	345,0	10	o. r.	o. r.	o. r.
907734	HELU-S-PK-CU 300-14	300,0	15,0	24,5	48,5	104,0	32	346,0	10	o. r.	o. r.	o. r.
907735	HELU-S-PK-CU 400-10	400,0	10,5	27,5	55,0	117,0	38	715,5	5	o. r.	o. r.	o. r.
907736	HELU-S-PK-CU 400-12	400,0	13,0	27,5	55,0	117,0	38	717,0	5	o. r.	o. r.	o. r.
907737	HELU-S-PK-CU 400-14	400,0	15,0	27,5	55,0	117,0	38	719,8	5	o. r.	o. r.	o. r.
907738	HELU-S-PK-CU 500-12	500,0	13,0	31,0	60,0	130,0	42	869,2	5	o. r.	o. r.	o. r.
907739	HELU-S-PK-CU 500-14	500,0	15,0	31,0	60,0	130,0	42	875,0	5	o. r.	o. r.	o. r.

Continuation ▶

HELU-S-PK-CU Tubular compression cable lugs - straight

Not insulated

Eye type

Part no.	Type	Cross-section mm ²	a mm	d mm	b mm	l mm	Code type	Weight kg / 1000 items	Unit	Net EUR/100 items at a purchase of		
										up to 100	101 - 500	501 - 1000
907740	HELU-S-PK-CU 500-16	500,0	17,0	31,0	60,0	130,0	42	889,0	5	o. r.	o. r.	o. r.
907741	HELU-S-PK-CU 625-12	625,0	13,0	34,5	63,0	135,0	44	842,7	5	o. r.	o. r.	o. r.
907742	HELU-S-PK-CU 625-14	625,0	15,0	34,5	63,0	135,0	44	838,9	5	o. r.	o. r.	o. r.
907743	HELU-S-PK-CU 625-16	625,0	17,0	34,5	63,0	135,0	44	820,5	5	o. r.	o. r.	o. r.
907745	HELU-S-PK-CU 800-14	800,0	15,0	16,0	75,0	165,0	100	1486,0	2	o. r.	o. r.	o. r.
907746	HELU-S-PK-CU 800-16	800,0	17,0	40,0	75,0	165,0	100	1494,2	2	o. r.	o. r.	o. r.
907748	HELU-S-PK-CU 1000-16	1000,0	17,0	44,0	83,0	167,0	58	1937,0	2	o. r.	o. r.	o. r.

Dimensions and specifications may be changed without prior notice.

o. r. = on request

HELU-S-PK-CU-DIN Tubular compression cable lugs - straight



Tubular compression lug HELU-S-PK-CU-DIN

Uninsulated tubular compression lugs in eye type design for conductor arrangement RM, to DIN 46235.

Material

Socket: Copper according to DIN EN 13600
Surface: tin plated or optionally uncoated

Note

Code type indicates the required hexagonal clamping insert.
Compression instruction and instruction for assembly see chapter "Technical information".

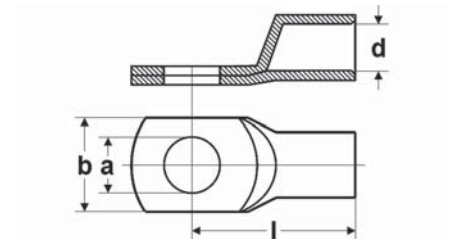

Diameter

- a Diameter of the boring
- d Inner diameter of the cable insertion
- b Flange width
- l Length till middle of the boring

Eye type

Part no.	Type	Cross-section mm ²	a mm	d mm	b mm	l mm	Code type	Weight kg / 1000 items	Unit	Net EUR/100 items at a purchase of		
										up to 100	101 - 500	501 - 1000
907677	HELU-S-PK-CU-DIN 6-5	6,0	5,3	3,7	8,5	24,0	5	3,1	100	o. r.	o. r.	o. r.
907678	HELU-S-PK-CU-DIN 6-6	6,0	6,4	3,7	3,7	24,0	5	3,4	100	o. r.	o. r.	o. r.
907680	HELU-S-PK-CU-DIN 10-5	10,0	5,3	4,4	10,0	27,0	6	3,5	100	o. r.	o. r.	o. r.
907681	HELU-S-PK-CU-DIN 10-6	10,0	6,4	4,4	10,0	27,0	6	3,7	100	o. r.	o. r.	o. r.
907685	HELU-S-PK-CU-DIN 16-6	16,0	6,4	5,5	13,0	36,0	8	12,7	100	o. r.	o. r.	o. r.
907686	HELU-S-PK-CU-DIN 16-8	16,0	8,4	5,5	13,0	37,0	8	13,0	100	o. r.	o. r.	o. r.
907687	HELU-S-PK-CU-DIN 16-10	16,0	10,5	5,5	16,5	38,0	8	13,2	100	o. r.	o. r.	o. r.
907689	HELU-S-PK-CU-DIN 25-6	25,0	6,4	7,0	14,0	39,0	10	16,2	100	o. r.	o. r.	o. r.
907690	HELU-S-PK-CU-DIN 25-8	25,0	8,4	7,0	17,0	39,0	10	17,3	100	o. r.	o. r.	o. r.
907691	HELU-S-PK-CU-DIN 25-10	25,0	10,5	7,0	17,0	40,5	10	17,7	100	o. r.	o. r.	o. r.
907692	HELU-S-PK-CU-DIN 25-12	25,0	13,0	7,0	18,0	40,5	10	17,2	100	o. r.	o. r.	o. r.
907695	HELU-S-PK-CU-DIN 35-8	35,0	8,4	8,2	18,0	42,0	12	31,9	100	o. r.	o. r.	o. r.
907696	HELU-S-PK-CU-DIN 35-10	35,0	10,5	8,2	20,0	42,5	12	31,7	100	o. r.	o. r.	o. r.
907697	HELU-S-PK-CU-DIN 35-12	35,0	13,0	8,2	21,0	44,0	12	31,1	100	o. r.	o. r.	o. r.
907701	HELU-S-PK-CU-DIN 50-8	50,0	8,4	9,8	20,0	52,0	14	50,0	100	o. r.	o. r.	o. r.
907702	HELU-S-PK-CU-DIN 50-10	50,0	10,5	9,8	22,0	52,0	14	49,4	100	o. r.	o. r.	o. r.
907703	HELU-S-PK-CU-DIN 50-12	50,0	13,0	9,8	23,0	52,0	14	49,1	100	o. r.	o. r.	o. r.
907705	HELU-S-PK-CU-DIN 50-16	50,0	17,0	9,8	28,0	55,5	14	50,4	100	o. r.	o. r.	o. r.
907707	HELU-S-PK-CU-DIN 70-8	70,0	8,4	11,3	24,0	56,0	16	65,4	50	o. r.	o. r.	o. r.
907708	HELU-S-PK-CU-DIN 70-10	70,0	10,5	11,3	24,0	56,0	16	65,4	50	o. r.	o. r.	o. r.
907709	HELU-S-PK-CU-DIN 70-12	70,0	13,0	11,3	24,0	56,5	16	65,7	50	o. r.	o. r.	o. r.
907711	HELU-S-PK-CU-DIN 70-16	70,0	17,0	11,3	29,0	57,0	16	69,2	50	o. r.	o. r.	o. r.
906524	HELU-S-PK-CU-DIN 95-10	95,0	10,5	13,5	28,0	65,5	18	95,5	50	o. r.	o. r.	o. r.
906525	HELU-S-PK-CU-DIN 95-12	95,0	13,0	13,5	28,0	65,5	18	94,5	50	o. r.	o. r.	o. r.
907715	HELU-S-PK-CU-DIN 95-16	95,0	17,0	13,5	30,0	65,5	18	94,4	50	o. r.	o. r.	o. r.
907716	HELU-S-PK-CU-DIN 95-20	95,0	21,0	13,5	33,0	71,0	18	98,6	50	o. r.	o. r.	o. r.
906526	HELU-S-PK-CU-DIN 120-10	120,0	10,5	15,5	31,0	70,0	20	114,0	50	o. r.	o. r.	o. r.
906527	HELU-S-PK-CU-DIN 120-12	120,0	13,0	15,5	31,0	70,5	20	114,3	50	o. r.	o. r.	o. r.
907719	HELU-S-PK-CU-DIN 120-16	120,0	17,0	15,5	31,5	70,0	20	113,6	50	o. r.	o. r.	o. r.
907720	HELU-S-PK-CU-DIN 120-20	120,0	21,0	15,5	36,0	72,0	20	115,1	50	o. r.	o. r.	o. r.
907722	HELU-S-PK-CU-DIN 150-10	150,0	10,5	17,0	34,0	79,0	22	164,6	25	o. r.	o. r.	o. r.
906528	HELU-S-PK-CU-DIN 150-12	150,0	13,0	17,0	34,0	78,5	22	165,3	25	o. r.	o. r.	o. r.
906529	HELU-S-PK-CU-DIN 150-16	150,0	17,0	17,0	34,0	78,0	22	163,5	25	o. r.	o. r.	o. r.
907724	HELU-S-PK-CU-DIN 150-20	150,0	21,0	17,0	38,0	78,0	22	163,4	25	o. r.	o. r.	o. r.
907726	HELU-S-PK-CU-DIN 185-10	185,0	10,5	19,0	37,0	83,0	25	185,0	25	o. r.	o. r.	o. r.
906530	HELU-S-PK-CU-DIN 185-12	185,0	13,0	19,0	37,0	82,5	25	189,5	25	o. r.	o. r.	o. r.
906531	HELU-S-PK-CU-DIN 185-16	185,0	17,0	19,0	37,0	82,0	25	194,1	25	o. r.	o. r.	o. r.

Continuation ►

HELU-S-PK-CU-DIN Tubular compression cable lugs - straight

Eye type

Part no.	Type	Cross-section mm ²	a mm	d mm	b mm	l mm	Code type	Weight kg / 1000 items	Unit	Net EUR/100 items at a purchase of		
										up to 100	101 - 500	501 - 1000
907728	HELU-S-PK-CU-DIN 185-20	185,0	21,0	19,0	40,0	83,0	25	190,1	25	o. r.	o. r.	o. r.
906532	HELU-S-PK-CU-DIN 240-12	240,0	13,0	21,5	42,5	92,0	28	266,5	20	o. r.	o. r.	o. r.
906533	HELU-S-PK-CU-DIN 240-16	240,0	17,0	21,5	42,5	92,0	28	274,5	20	o. r.	o. r.	o. r.
907731	HELU-S-PK-CU-DIN 240-20	240,0	21,0	21,5	45,0	92,0	28	276,7	20	o. r.	o. r.	o. r.
906534	HELU-S-PK-CU-DIN 300-16	300,0	17,0	24,5	48,5	100,0	32	341,6	10	o. r.	o. r.	o. r.
906535	HELU-S-PK-CU-DIN 300-20	300,0	21,0	24,5	48,5	100,0	32	344,6	10	o. r.	o. r.	o. r.
906536	HELU-S-PK-CU-DIN 400-16	400,0	17,0	27,5	55,0	117,0	38	717,5	5	o. r.	o. r.	o. r.
906537	HELU-S-PK-CU-DIN 400-20	400,0	21,0	27,5	55,0	117,0	38	706,4	5	o. r.	o. r.	o. r.
906538	HELU-S-PK-CU-DIN 500-20	500,0	21,0	31,0	60,0	130,0	42	876,6	5	o. r.	o. r.	o. r.
907744	HELU-S-PK-CU-DIN 625-20	625,0	21,0	34,5	63,0	135,0	44	820,5	5	o. r.	o. r.	o. r.
907747	HELU-S-PK-CU-DIN 800-20	800,0	21,0	40,0	75,0	165,0	100	1455,5	2	o. r.	o. r.	o. r.
907749	HELU-S-PK-CU-DIN 1000-20	1000,0	21,0	44,0	83,0	167,0	58	1890,0	2	o. r.	o. r.	o. r.

Dimensions and specifications may be changed without prior notice.

o. r. = on request

HELU-S-PK-AL-DIN Tubular compression cable lugs

uninsulated



Compression cable lug HELU-S-PK-AL-DIN

Uninsulated, straight tubular cable lug in eye type design made of aluminium. High quality version for reliable crimping. Designed for conductor type RM acc. to DIN 48201 and circularly reshaped conductors.

Material

AL 99,5
Surface: bare

Note

Code type indicates the required hexagonal crimping insert.
Sleeves are pre-filled with contact grease and sealed with plastic plug
Compression instruction and instruction for assembly see chapter "Technical information".

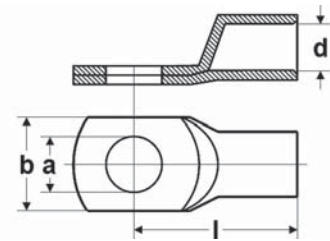

Dimensions

a Diameter of the bore
d Inner diameter of the cable inclusion
b Flange width
l Length to middle of the bore

Eye type

Part no.	Type	Cross-section RM/SM - SE mm ²	a mm	d mm	b mm	l mm	Code type	Weight kg / 1000 items	Unit	Net EUR/100 items at a purchase of		
										up to 100	101 - 500	501 - 1000
907865	HELU-S-PK-AL-DIN 16-8	16,0 - 25,0	8,4	5,6	16,0	52,0	12	9,6	50	o. r.	o. r.	o. r.
907866	HELU-S-PK-AL-DIN 16-10	16,0 - 25,0	10,5	5,6	18,0	52,0	12	9,7	50	o. r.	o. r.	o. r.
907867	HELU-S-PK-AL-DIN 25-8	25,0 - 35,0	8,4	6,8	16,0	60,0	12	14,8	50	o. r.	o. r.	o. r.
907868	HELU-S-PK-AL-DIN 25-10	25,0 - 35,0	10,5	6,8	18,0	60,0	12	15,3	50	o. r.	o. r.	o. r.
907869	HELU-S-PK-AL-DIN 35-8	35,0 - 50,0	8,4	8,0	20,0	67,0	14	24,5	50	o. r.	o. r.	o. r.
907870	HELU-S-PK-AL-DIN 35-10	35,0 - 50,0	10,5	8,0	20,0	67,0	14	24,5	50	o. r.	o. r.	o. r.
907871	HELU-S-PK-AL-DIN 35-12	35,0 - 50,0	13,0	8,0	20,0	67,0	14	23,5	50	o. r.	o. r.	o. r.
907872	HELU-S-PK-AL-DIN 50-8	50,0 - 70,0	8,4	10,0	23,0	74,0	16	32,9	25	o. r.	o. r.	o. r.
907873	HELU-S-PK-AL-DIN 50-10	50,0 - 70,0	10,5	10,0	23,0	74,0	16	28,8	25	o. r.	o. r.	o. r.
907874	HELU-S-PK-AL-DIN 50-12	50,0 - 70,0	13,0	10,0	23,0	74,0	16	33,8	25	o. r.	o. r.	o. r.
907875	HELU-S-PK-AL-DIN 70-10	70,0 - 95,0	10,5	11,5	28,0	84,0	18	47,7	25	o. r.	o. r.	o. r.
907876	HELU-S-PK-AL-DIN 70-12	70,0 - 95,0	13,0	11,5	28,0	87,0	18	47,3	25	o. r.	o. r.	o. r.
907877	HELU-S-PK-AL-DIN 95-10	95,0 - 120,0	10,5	13,2	32,0	90,0	22	70,1	10	o. r.	o. r.	o. r.
907878	HELU-S-PK-AL-DIN 95-12	95,0 - 120,0	13,0	13,2	32,0	90,0	22	78,2	10	o. r.	o. r.	o. r.
907879	HELU-S-PK-AL-DIN 95-16	95,0 - 120,0	17,0	13,2	32,0	90,0	22	76,2	10	o. r.	o. r.	o. r.
907880	HELU-S-PK-AL-DIN 120-10	120,0 - 150,0	10,5	14,7	32,0	98,0	22	83,8	10	o. r.	o. r.	o. r.
907881	HELU-S-PK-AL-DIN 120-12	120,0 - 150,0	13,0	14,7	32,0	98,0	22	87,9	10	o. r.	o. r.	o. r.
907882	HELU-S-PK-AL-DIN 120-16	120,0 - 150,0	17,0	14,7	32,0	98,0	22	86,4	10	o. r.	o. r.	o. r.
906459	HELU-S-PK-AL-DIN 150-10	150,0 - 185,0	10,5	16,3	35,0	104,0	25	99,8	10	o. r.	o. r.	o. r.
906436	HELU-S-PK-AL-DIN 150-12	150,0 - 185,0	13,0	16,3	35,0	104,0	25	102,3	10	o. r.	o. r.	o. r.
906461	HELU-S-PK-AL-DIN 150-16	150,0 - 185,0	13,0	16,3	35,0	104,0	25	100,8	10	o. r.	o. r.	o. r.
906462	HELU-S-PK-AL-DIN 150-20	150,0 - 185,0	21,0	16,3	35,0	104,0	25	100,2	10	o. r.	o. r.	o. r.
907883	HELU-S-PK-AL-DIN 185-10	185,0 - 240,0	10,5	18,5	40,0	109,0	28	133,9	10	o. r.	o. r.	o. r.
906463	HELU-S-PK-AL-DIN 185-12	185,0 - 240,0	13,0	18,5	40,0	109,0	28	133,9	10	o. r.	o. r.	o. r.
906464	HELU-S-PK-AL-DIN 185-16	185,0 - 240,0	17,0	18,5	40,0	109,0	28	137,5	10	o. r.	o. r.	o. r.
906465	HELU-S-PK-AL-DIN 185-20	185,0 - 240,0	21,0	18,5	40,0	109,0	28	137,5	10	o. r.	o. r.	o. r.
907884	HELU-S-PK-AL-DIN 240-10	240,0 - 300,0	10,5	21,0	46,0	119,0	32	182,8	10	o. r.	o. r.	o. r.
906466	HELU-S-PK-AL-DIN 240-12	240,0 - 300,0	13,0	21,0	46,0	119,0	32	179,4	10	o. r.	o. r.	o. r.
906467	HELU-S-PK-AL-DIN 240-16	240,0 - 300,0	17,0	21,0	46,0	119,0	32	176,2	10	o. r.	o. r.	o. r.
906468	HELU-S-PK-AL-DIN 240-20	240,0 - 300,0	21,0	21,0	46,0	119,0	32	179,0	10	o. r.	o. r.	o. r.
906469	HELU-S-PK-AL-DIN 300-12	300,0	13,0	23,3	50,0	125,0	34	205,4	5	o. r.	o. r.	o. r.
906470	HELU-S-PK-AL-DIN 300-16	300,0	17,0	23,3	50,0	125,0	34	201,4	5	o. r.	o. r.	o. r.
906471	HELU-S-PK-AL-DIN 300-20	300,0	21,0	23,3	50,0	125,0	34	194,3	5	o. r.	o. r.	o. r.
906472	HELU-S-PK-AL-DIN 400-12	400,0	13,0	26,0	55,0	120,0	38	283,0	5	o. r.	o. r.	o. r.
906473	HELU-S-PK-AL-DIN 400-16	400,0	17,0	26,0	55,0	120,0	38	273,3	5	o. r.	o. r.	o. r.
906474	HELU-S-PK-AL-DIN 400-20	400,0	21,0	26,0	55,0	120,0	38	240,0	5	o. r.	o. r.	o. r.
906475	HELU-S-PK-AL-DIN 500-12	500,0	13,0	29,0	63,0	140,0	44	380,0	5	o. r.	o. r.	o. r.
906476	HELU-S-PK-AL-DIN 500-16	500,0	17,0	29,0	63,0	140,0	44	378,0	5	o. r.	o. r.	o. r.
906477	HELU-S-PK-AL-DIN 500-20	500,0	21,0	29,0	63,0	140,0	44	373,5	5	o. r.	o. r.	o. r.

Dimensions and specifications may be changed without prior notice.

o. r. = on request

HELU-S-PK-AL/CU Aluminium / Copper compression cable lug – straight



Compression cable lug HELU-S-PK-AL/CU

Non-insulated, straight compression lug in eye type design made of aluminium. High quality version for reliable crimping. Designed for conductor type RM and circularly reshaped conductors.

Material

Socket: Al 99,5 and Cu acc. to DIN EN 13601
Surface: bare

Note

Code type indicates the required hexagonal crimping insert.
Al-sleeves are prefilled with contact grease and sealed with plastic plugs
Compression instruction and instruction for assembly see chapter "Technical information".

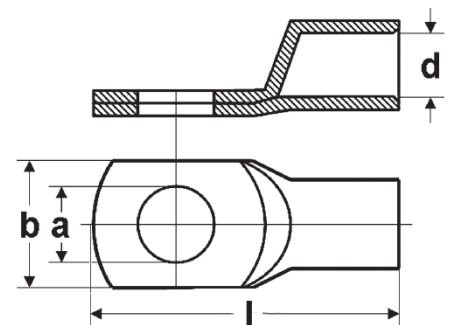

Dimensions

- a Diameter of the boring
- d Inner diameter of the cable inclusion
- b Flange width
- l Length

Eye type

Part no.	Cross-section RM/SM - SE mm ²	Boring M	a mm	d mm	b mm	l mm	Code type	Weight kg / 1000 items	Unit	Net EUR/ 100 items at a purchase of		
										up to 500	501 - 1000	1001 - 5000
907568	10 - -	8	8,4	5,0	20,0	50,0	10	26,5	25	o. r.	o. r.	o. r.
907569	16 - 25	8	8,4	5,6	20,0	60,0	12	35,4	25	o. r.	o. r.	o. r.
907570	16 - 25	10	10,5	5,6	20,0	60,0	12	34,2	25	o. r.	o. r.	o. r.
907571	25 - 35	8	8,4	6,8	20,0	65,0	12	35,7	25	o. r.	o. r.	o. r.
907572	25 - 35	10	10,5	6,8	20,0	65,0	12	34,4	25	o. r.	o. r.	o. r.
907573	25 - 35	12	13,0	6,8	26,0	67,0	12	44,5	25	o. r.	o. r.	o. r.
907574	35 - 50	8	8,4	8,0	20,0	75,0	14	45,5	25	o. r.	o. r.	o. r.
907575	35 - 50	10	10,5	8,0	20,0	75,0	14	44,2	25	o. r.	o. r.	o. r.
907576	35 - 50	12	13,0	8,0	26,0	75,0	14	51,5	25	o. r.	o. r.	o. r.
907577	50 - 70	8	8,4	9,8	20,0	75,0	16	48,7	25	o. r.	o. r.	o. r.
907578	50 - 70	10	10,5	9,8	20,0	75,0	16	47,2	25	o. r.	o. r.	o. r.
907579	50 - 70	12	13,0	9,8	26,0	75,0	16	59,9	25	o. r.	o. r.	o. r.
907580	70 - 95	8	8,4	11,2	26,0	85,0	18	61,9	10	o. r.	o. r.	o. r.
907581	70 - 95	10	10,5	11,2	26,0	10,0	18	73,7	10	o. r.	o. r.	o. r.
907582	70 - 95	12	13,0	11,2	26,0	85,0	18	73,7	10	o. r.	o. r.	o. r.
907583	70 - 95	16	17,0	11,2	30,0	88,0	18	81,0	10	o. r.	o. r.	o. r.
907584	95 - 120	8	8,4	13,2	26,0	86,0	22	102,9	10	o. r.	o. r.	o. r.
907585	95 - 120	10	10,5	13,2	26,0	86,0	22	105,9	10	o. r.	o. r.	o. r.
907586	95 - 120	12	13,0	13,2	26,0	86,0	22	103,4	10	o. r.	o. r.	o. r.
907587	95 - 120	16	17,0	13,2	30,0	88,0	22	109,9	10	o. r.	o. r.	o. r.
907588	120 - 150	8	8,4	14,7	26,0	88,0	22	106,8	10	o. r.	o. r.	o. r.
907589	120 - 150	10	10,5	14,7	26,0	88,0	22	106,8	10	o. r.	o. r.	o. r.
907590	120 - 150	12	13,0	14,7	26,0	88,0	22	104,5	10	o. r.	o. r.	o. r.
907591	120 - 150	16	17,0	14,7	30,0	90,0	22	114,5	10	o. r.	o. r.	o. r.
907592	150 - 185	8	8,4	16,3	30,0	100,0	25	138,8	5	o. r.	o. r.	o. r.
906478	150 - 185	10	10,5	16,3	30,0	100,0	25	138,0	5	o. r.	o. r.	o. r.
906172	150 - 185	12	13,0	16,3	30,0	100,0	25	135,7	5	o. r.	o. r.	o. r.
906173	150 - 185	16	17,0	16,3	30,0	100,0	25	128,8	5	o. r.	o. r.	o. r.
907593	185 - 240	8	8,4	18,3	30,0	102,0	28	183,7	5	o. r.	o. r.	o. r.
906479	185 - 240	10	10,5	18,3	30,0	102,0	28	176,1	5	o. r.	o. r.	o. r.
906480	185 - 240	12	13,0	18,3	30,0	102,0	28	173,1	5	o. r.	o. r.	o. r.
906481	185 - 240	16	17,0	18,3	36,0	105,0	28	196,8	5	o. r.	o. r.	o. r.
906482	185 - 240	20	21,0	18,3	36,0	105,0	28	189,7	5	o. r.	o. r.	o. r.
906483	240 - 300	10	10,5	21,0	30,0	112,0	32	204,1	5	o. r.	o. r.	o. r.
906185	240 - 300	12	13,0	21,0	30,0	112,0	32	204,1	5	o. r.	o. r.	o. r.
906484	240 - 300	16	17,0	21,0	36,0	115,0	32	225,8	5	o. r.	o. r.	o. r.
906485	240 - 300	20	21,0	21,0	36,0	115,0	32	218,5	5	o. r.	o. r.	o. r.

Continuation ▶

HELU-S-PK-AL/CU Aluminium / Copper compression cable lug – straight

Eye type

Part no.	Cross-section RM/SM - SE mm ²	Boring M	a mm	d mm	b mm	l mm	Code type	Weight kg / 1000 items	Unit	Net EUR/100 items at a purchase of		
										up to 500	501 - 1000	1001 - 5000
906486	300 - -	10	10,5	23,3	30,0	115,0	34	218,4	5	o. r.	o. r.	o. r.
906487	300 - -	12	13,0	23,3	30,0	116,0	34	226,4	5	o. r.	o. r.	o. r.
906488	300 - -	16	17,0	23,3	36,0	116,0	34	232,2	5	o. r.	o. r.	o. r.
906489	300 - -	20	21,0	23,3	36,0	116,0	34	225,0	5	o. r.	o. r.	o. r.
906490	400 - -	10	10,5	26,0	36,0	125,0	38	328,7	5	o. r.	o. r.	o. r.
906212	400 - -	12	13,0	26,0	36,0	125,0	38	332,7	5	o. r.	o. r.	o. r.
906174	400 - -	16	17,0	26,0	36,0	125,0	38	352,6	5	o. r.	o. r.	o. r.
906175	400 - -	20	21,0	26,0	36,0	125,0	38	341,5	5	o. r.	o. r.	o. r.
906491	500 - -	10	10,5	29,0	44,0	140,0	44	437,1	1	o. r.	o. r.	o. r.
906492	500 - -	12	13,0	29,0	44,0	140,0	44	433,3	1	o. r.	o. r.	o. r.
906493	500 - -	16	17,0	29,0	44,0	140,0	44	428,3	1	o. r.	o. r.	o. r.
906494	500 - -	20	21,0	29,0	44,0	140,0	44	420,8	1	o. r.	o. r.	o. r.
907594	625 - -	12	13,0	35,0	50,0	177,0	52	630,1	1	o. r.	o. r.	o. r.
907595	625 - -	16	17,0	35,0	50,0	177,0	52	770,0	1	o. r.	o. r.	o. r.
907596	625 - -	20	21,0	35,0	50,0	177,0	52	763,0	1	o. r.	o. r.	o. r.

Dimensions and specifications may be changed without prior notice.

o. r. = on request

KAC-U AL/CU-bi-metallic washer



Washer KAC-U

Bi-metallic washer for the processing of aluminium-copper materials.
Only for use in dry areas.

Material

E-Al, one side copper plated

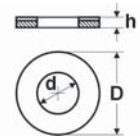

Dimensions

D Outer diameter
d Inner diameter
h Height

Part no.	Size	Inner Ø mm	Outer Ø mm	Thickness mm	Unit	Net EUR/ 100 items at a purchase of		
						up to 100	101 - 500	501 - 1000
906049	M8 x 1,5	8,5	18,0	1,0	10	o. r.	o. r.	o. r.
906050	M10 x 1,5	11,0	22,0	2,0	10	o. r.	o. r.	o. r.
906051	M12 x 1,5	13,0	28,0	2,0	10	o. r.	o. r.	o. r.
906052	M14 x 1,5	15,0	28,0	2,0	10	o. r.	o. r.	o. r.
906053	M16 x 1,5	17,0	35,0	2,0	10	o. r.	o. r.	o. r.

Dimensions and specifications may be changed without prior notice.

o. r. = on request

HELU-S-RK-N Nickel tubular cable lug - straight

Not insulated

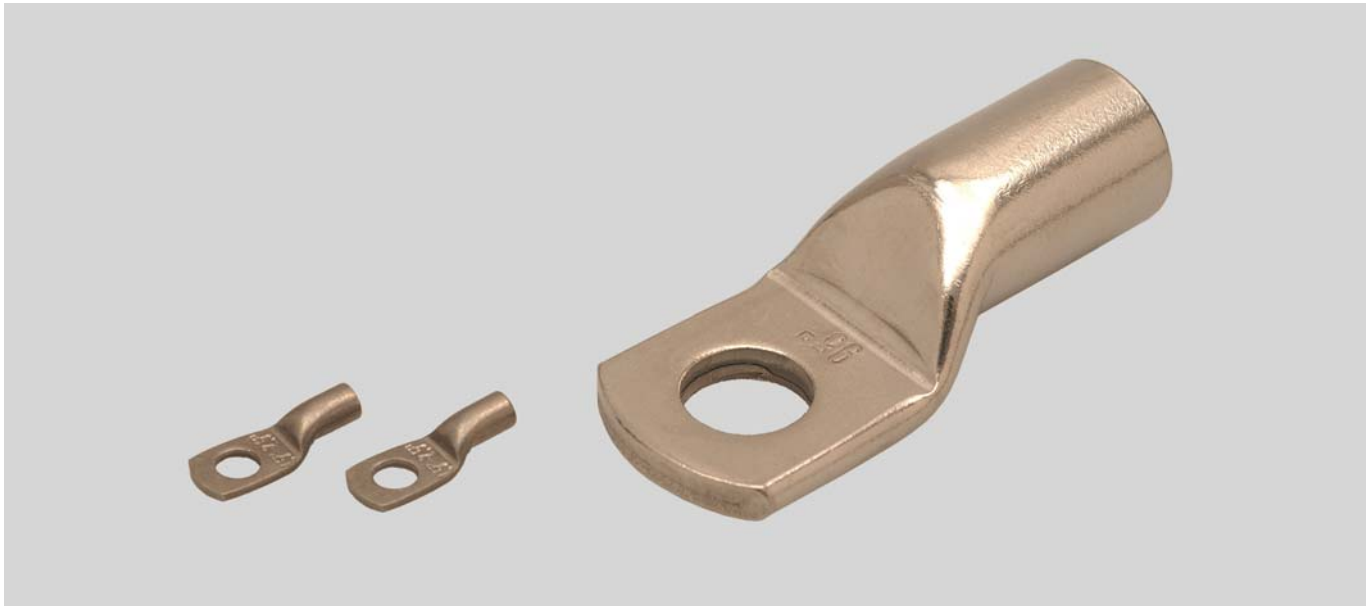

Tubular cable lug HELU-S-RK-N

Non-insulated tubular cable lugs in eye type design. High definition version for reliable crimping.

Material

Nickel

Technical data

Temperature range: up to +500°C

a diameter hole
d clearance
b width
l length to center of hole
t wall thickness

Eye type

Part no.	Type	Cross-section mm ²	a mm	d mm	b mm	t mm	l mm	Code type	Weight kg / 1000 items	Unit	Net EUR/100 items at a purchase of		
											up to 100	101 - 500	501 - 1000
98267	HELU-S-RK-N 1-4	0,5 - 1	4,3	1,6	6,5	0,8	13,0	-	0,8	100	o. r.	o. r.	o. r.
98268	HELU-S-RK-N 1-5	0,5 - 1	5,3	1,6	7,5	0,8	14,0	-	0,8	100	o. r.	o. r.	o. r.
97805	HELU-S-RK-N 2,5-4	1,5 - 2,5	4,3	2,3	7,0	0,8	13,0	-	1,1	100	o. r.	o. r.	o. r.
97806	HELU-S-RK-N 2,5-5	1,5 - 2,5	5,3	2,3	7,5	0,8	14,0	-	1,1	100	o. r.	o. r.	o. r.
97807	HELU-S-RK-N 2,5-6	1,5 - 2,5	6,5	2,3	9,5	0,8	16,0	-	1,3	100	o. r.	o. r.	o. r.
98269	HELU-S-RK-N 6-4	4 - 6	4,3	3,6	9,5	1,0	18,0	-	2,8	100	o. r.	o. r.	o. r.
97808	HELU-S-RK-N 6-5	4 - 6	5,3	3,6	9,5	1,0	19,0	-	2,8	100	o. r.	o. r.	o. r.
97809	HELU-S-RK-N 6-6	4 - 6	6,5	3,6	9,5	1,0	19,0	-	2,6	100	o. r.	o. r.	o. r.
98270	HELU-S-RK-N 10-5	10,0	5,5	4,5	12,0	1,0	21,0	-	3,4	100	o. r.	o. r.	o. r.
98271	HELU-S-RK-N 10-6	10,0	6,5	4,5	12,0	1,0	22,0	-	3,6	100	o. r.	o. r.	o. r.
98272	HELU-S-RK-N 16-5	16,0	5,5	5,5	12,0	1,0	26,0	-	4,7	100	o. r.	o. r.	o. r.
98273	HELU-S-RK-N 16-6	16,0	6,5	5,5	12,0	1,0	27,0	-	4,8	100	o. r.	o. r.	o. r.
98274	HELU-S-RK-N 16-8	16,0	8,5	5,5	13,5	1,0	29,0	-	5,6	100	o. r.	o. r.	o. r.
98275	HELU-S-RK-N 25-6	25,0	6,5	7,0	14,0	1,5	30,0	-	12,0	50	o. r.	o. r.	o. r.
98276	HELU-S-RK-N 25-8	25,0	8,5	7,0	16,0	1,5	32,0	-	13,2	50	o. r.	o. r.	o. r.
98277	HELU-S-RK-N 35-6	35,0	6,5	8,5	17,0	1,75	32,0	-	18,5	50	o. r.	o. r.	o. r.
98278	HELU-S-RK-N 35-8	35,0	8,5	8,5	17,0	1,75	34,0	-	20,0	50	o. r.	o. r.	o. r.
98279	HELU-S-RK-N 50-8	50,0	8,5	10,0	20,0	2,0	37,0	-	29,0	50	o. r.	o. r.	o. r.
98280	HELU-S-RK-N 50-10	50,0	10,5	10,0	20,0	2,0	39,0	-	31,0	50	o. r.	o. r.	o. r.
98281	HELU-S-RK-N 70-10	70,0	10,5	12,0	23,0	2,25	44,0	-	46,0	25	o. r.	o. r.	o. r.
98282	HELU-S-RK-N 70-12	70,0	13,0	12,0	23,0	2,25	46,0	-	46,6	25	o. r.	o. r.	o. r.
98283	HELU-S-RK-N 95-10	95,0	10,5	13,5	26,0	2,25	48,0	-	55,5	25	o. r.	o. r.	o. r.
98284	HELU-S-RK-N 95-12	95,0	13,0	13,5	26,0	2,25	49,0	-	56,0	25	o. r.	o. r.	o. r.

Dimensions and specifications may be changed without prior notice.

o. r. = on request

HELU-S-SV-CU Copper tubular butt connectors



Compression joint HELU-S-SV-CU

Clamping connection sleeves for unstrained clamping.
Type: With wirestop

Material

Socket: Cu according to DIN EN 13600
Surface: tin plated

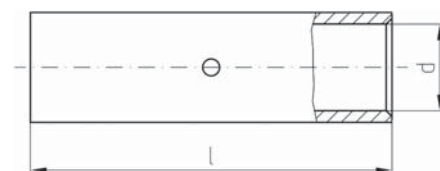

Dimensions

d Inner diameter of the cable inclusion
l Length

CM - blank

Part no.	Type	Cross-section mm ²	d mm	l mm	Code type	Weight kg / 1000 items	Unit	Net EUR/ 100 items at a purchase of		
								up to 100	101 - 500	501 - 1000
907811	HELU-S-SV-CU 0,5-0,75	0,5	1,4	15,0	-	0,8	100	o. r.	o. r.	o. r.
907812	HELU-S-SV-CU 1-1,5	1,0	1,9	15,0	-	1,2	100	o. r.	o. r.	o. r.
907813	HELU-S-SV-CU 2,5	2,5	2,4	16,0	-	1,5	100	o. r.	o. r.	o. r.
907814	HELU-S-SV-CU 4	4,0	3,0	19,0	-	2,1	100	o. r.	o. r.	o. r.
907815	HELU-S-SV-CU 6	6,0	3,5	25,0	-	5,1	100	o. r.	o. r.	o. r.
907816	HELU-S-SV-CU 10	10,0	4,5	30,0	-	6,0	50	o. r.	o. r.	o. r.
907817	HELU-S-SV-CU 16	16,0	5,5	35,0	-	10,0	50	o. r.	o. r.	o. r.
907818	HELU-S-SV-CU 25	25,0	7,0	40,0	-	14,1	50	o. r.	o. r.	o. r.
907819	HELU-S-SV-CU 35	35,0	8,5	45,0	-	21,6	50	o. r.	o. r.	o. r.
907820	HELU-S-SV-CU 50	50,0	10,0	50,0	-	33,2	50	o. r.	o. r.	o. r.
907821	HELU-S-SV-CU 70	70,0	12,0	55,0	-	49,1	50	o. r.	o. r.	o. r.
907822	HELU-S-SV-CU 95	95,0	13,5	60,0	-	60,9	50	o. r.	o. r.	o. r.
907823	HELU-S-SV-CU 120	120,0	15,0	65,0	-	78,8	25	o. r.	o. r.	o. r.
907824	HELU-S-SV-CU 150	150,0	16,8	70,0	-	86,8	25	o. r.	o. r.	o. r.
907825	HELU-S-SV-CU 185	185,0	19,0	75,0	-	116,3	25	o. r.	o. r.	o. r.
907826	HELU-S-SV-CU 240	240,0	21,0	85,0	-	142,2	25	o. r.	o. r.	o. r.
907827	HELU-S-SV-CU 300	300,0	24,0	100,0	-	224,0	10	o. r.	o. r.	o. r.
907828	HELU-S-SV-CU 400	400,0	27,5	100,0	-	261,7	10	o. r.	o. r.	o. r.
907829	HELU-S-SV-CU 500	500,0	31,0	140,0	-	473,0	5	o. r.	o. r.	o. r.
907830	HELU-S-SV-CU 630	630,0	34,0	160,0	-	617,5	5	o. r.	o. r.	o. r.

Dimensions and specifications may be changed without prior notice.

o. r. = on request

HELU-S-PV-CU-DIN Copper compression joint



Compression joint HELU-S-PV-CU-DIN

Clamping connection sleeves for unstrained clamping of conductors built to DIN 46267.

Material

Socket: Copper
Surface: tinned

Note

- Code type indicates the required hexagonal clamping insert



Dimensions

d Inner diameter of the cable inclusion
l Length

Tinned

Part no.	Type	Cross-section mm ²	d mm	l mm	Code type	Weight kg / 1000 items	Unit	Net EUR/ 100 items at a purchase of		
								up to 100	101 - 500	501 - 1000
93263	HELU-S-PV-CU-DIN 6	6,0	3,8	30,0	5,0	3,4	50	o. r.	o. r.	o. r.
93264	HELU-S-PV-CU-DIN 10	10,0	4,5	30,0	6,0	3,4	50	o. r.	o. r.	o. r.
93265	HELU-S-PV-CU-DIN 16	16,0	5,5	50,0	8,0	14,9	50	o. r.	o. r.	o. r.
93266	HELU-S-PV-CU-DIN 25	25,0	7,0	50,0	10,0	18,0	50	o. r.	o. r.	o. r.
93267	HELU-S-PV-CU-DIN 35	35,0	8,2	50,0	12,0	31,5	50	o. r.	o. r.	o. r.
93268	HELU-S-PV-CU-DIN 50	50,0	10,0	56,0	14,0	43,7	50	o. r.	o. r.	o. r.
93269	HELU-S-PV-CU-DIN 70	70,0	11,5	56,0	16,0	55,4	25	o. r.	o. r.	o. r.
93270	HELU-S-PV-CU-DIN 95	95,0	13,5	70,0	18,0	88,4	25	o. r.	o. r.	o. r.
93271	HELU-S-PV-CU-DIN 120	120,0	15,5	70,0	20,0	99,2	25	o. r.	o. r.	o. r.
93272	HELU-S-PV-CU-DIN 150	150,0	17,0	80,0	22,0	148,6	10	o. r.	o. r.	o. r.
93273	HELU-S-PV-CU-DIN 185	185,0	19,0	85,0	25,0	173,5	10	o. r.	o. r.	o. r.
93274	HELU-S-PV-CU-DIN 240	240,0	21,5	90,0	28,0	240,3	10	o. r.	o. r.	o. r.
93275	HELU-S-PV-CU-DIN 300	300,0	24,5	100,0	32,0	298,6	10	o. r.	o. r.	o. r.

Dimensions and specifications may be changed without prior notice.

o. r. = on request

HELU-S-PV-AL-DIN Aluminium press connector



Press connector HELU-S-PV-AL-DIN

Press connector for strain-relieved connections of conductors designed acc. to DIN 46267 part 2.

Material

Socket: Al 99,5
Surface: bare

Note

- Code type indicates the required hexagonal crimping insert.
- Part No. 907835 is not standardized.
- Sleeves are prefilled with contact grease and sealed with plastic plug.

Technical data

Temperature range: up to +120°C

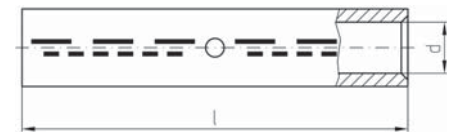

Dimensions

d Inner diameter of the cable inclusion
l Length

Bare

Part no.	Cross-section RM/SM - SE mm ²	d mm	l mm	Code type	Weight kg / 1000 items	Unit	Net EUR/100 items at a purchase of		
							up to 100	101 - 500	501 - 1000
907835	16 - 25	5,6	55,0	12	13,4	50	o. r.	o. r.	o. r.
906511	25 - 35	6,8	70,0	12	15,4	50	o. r.	o. r.	o. r.
906512	35 - 50	8,0	85,0	14	28,5	50	o. r.	o. r.	o. r.
906513	50 - 70	10,0	85,0	16	34,0	25	o. r.	o. r.	o. r.
906514	70 - 95	11,5	105,0	18	55,9	25	o. r.	o. r.	o. r.
906515	95 - 120	13,2	105,0	22	82,1	10	o. r.	o. r.	o. r.
906516	120 - 150	14,7	105,0	22	86,4	10	o. r.	o. r.	o. r.
906406	150 - 185	16,3	125,0	25	111,3	10	o. r.	o. r.	o. r.
906517	185 - 240	18,5	125,0	28	143,5	10	o. r.	o. r.	o. r.
906518	240 - 300	21,0	145,0	32	191,7	10	o. r.	o. r.	o. r.
906519	300 - -	23,3	145,0	34	227,1	10	o. r.	o. r.	o. r.
906520	400 - -	26,0	210,0	38	359,0	5	o. r.	o. r.	o. r.
906521	500 - -	29,0	210,0	44	455,0	5	o. r.	o. r.	o. r.

Dimensions and specifications may be changed without prior notice.

o. r. = on request

HELU-S-PV-AL/CU Aluminium / Copper press connector



Press Connector HELU-S-PV-AL/CU

Press connector for aluminium conductors, strain relieved

Material

Socket: Al 99,5 and Cu acc. to DIN EN 13601
Surface: bare

Note

Al-sleeves are prefilled with contact grease and sealed with plastic plug.

Technical data

Temperature range: up to +120°C

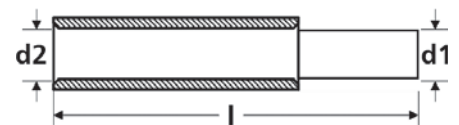

Dimensions

- d1 Inner diameter of the cable inclusion, copper side
- d2 Inner diameter of the cable inclusion, aluminium side
- l Length

Part no.	Cross-section AL RM/SM - SE mm ²	Cross-section CU SE mm ²	Code type AL / CU	d1 CU mm	d2 AL mm	l mm	Weight kg / 1000 items	Unit	Net EUR/ 100 items at a purchase of		
									up to 100	101 - 500	501 - 1000
907836	16 - 25	6	12 / 5	3,7	5,6	45,0	9,2	25	o. r.	o. r.	o. r.
907837	16 - 25	10	12 / 6	4,4	5,6	45,0	9,4	25	o. r.	o. r.	o. r.
907838	16 - 25	16	12 / 8	5,5	5,6	56,0	15,8	25	o. r.	o. r.	o. r.
907839	25 - 35	10	12 / 6	4,4	6,8	51,0	9,9	25	o. r.	o. r.	o. r.
907840	25 - 35	16	12 / 8	5,5	6,8	61,0	16,1	25	o. r.	o. r.	o. r.
907841	25 - 35	25	12 / 10	7,0	6,8	62,0	19,2	25	o. r.	o. r.	o. r.
907842	35 - 50	16	14 / 8	5,5	8,0	71,0	21,2	25	o. r.	o. r.	o. r.
907843	35 - 50	25	14 / 10	7,0	8,0	71,0	24,1	25	o. r.	o. r.	o. r.
907844	35 - 50	35	14 / 12	8,2	8,0	70,0	29,9	25	o. r.	o. r.	o. r.
907845	50 - 70	25	16 / 10	7,0	9,8	71,5	26,6	25	o. r.	o. r.	o. r.
907846	50 - 70	35	16 / 12	8,2	9,8	71,5	33,4	25	o. r.	o. r.	o. r.
907847	50 - 70	50	16 / 14	10,0	9,8	71,5	43,5	25	o. r.	o. r.	o. r.
907848	70 - 95	25	18 / 10	7,0	11,2	79,0	36,2	10	o. r.	o. r.	o. r.
907849	70 - 95	35	18 / 12	8,2	11,2	79,0	42,2	10	o. r.	o. r.	o. r.
907850	70 - 95	50	18 / 14	10,0	11,2	85,0	53,3	10	o. r.	o. r.	o. r.
907851	70 - 95	70	18 / 16	11,5	11,2	88,0	64,0	10	o. r.	o. r.	o. r.
907852	95 - 120	35	22 / 12	8,2	13,2	79,0	57,4	10	o. r.	o. r.	o. r.
907853	95 - 120	50	22 / 14	10,0	13,2	85,0	69,1	10	o. r.	o. r.	o. r.
907854	95 - 120	70	22 / 26	11,5	13,2	87,0	78,9	10	o. r.	o. r.	o. r.
907855	95 - 120	95	22 / 18	13,5	13,2	94,0	98,8	10	o. r.	o. r.	o. r.
907856	120 - 150	50	22 / 14	10,0	14,7	87,0	66,5	10	o. r.	o. r.	o. r.
907857	120 - 150	70	22 / 16	11,5	14,7	89,0	76,1	10	o. r.	o. r.	o. r.
907858	120 - 150	95	22 / 18	13,5	14,7	97,0	97,7	10	o. r.	o. r.	o. r.
907859	120 - 150	120	22 / 20	15,5	14,7	98,0	108,3	10	o. r.	o. r.	o. r.
906460	150 - 185	70	25 / 16	11,5	16,3	101,0	95,9	5	o. r.	o. r.	o. r.
906495	150 - 185	95	25 / 18	13,5	16,3	108,0	116,6	5	o. r.	o. r.	o. r.
906209	150 - 185	120	25 / 20	15,5	16,3	108,0	125,9	5	o. r.	o. r.	o. r.
906496	150 - 185	150	25 / 22	17,0	16,3	113,0	155,0	5	o. r.	o. r.	o. r.
906497	185 - 240	95	28 / 18	13,5	18,3	108,0	130,0	5	o. r.	o. r.	o. r.
906498	185 - 240	120	28 / 20	15,5	18,3	108,0	140,1	5	o. r.	o. r.	o. r.
906499	185 - 240	150	28 / 22	17,0	18,3	113,0	169,3	5	o. r.	o. r.	o. r.
906500	185 - 240	185	28 / 25	19,0	18,3	116,0	185,3	5	o. r.	o. r.	o. r.
906501	240 - 300	120	32 / 20	15,5	21,0	120,0	173,6	5	o. r.	o. r.	o. r.
906502	240 - 300	150	32 / 22	17,0	21,0	124,0	200,8	5	o. r.	o. r.	o. r.
906503	240 - 300	185	32 / 25	19,0	21,0	127,0	218,4	5	o. r.	o. r.	o. r.
906504	240 - 300	240	32 / 28	21,5	21,0	132,0	280,0	5	o. r.	o. r.	o. r.
906505	300 - -	150	34 / 22	17,0	23,3	124,0	205,1	5	o. r.	o. r.	o. r.
906506	300 - -	185	34 / 25	19,0	23,3	128,0	225,8	5	o. r.	o. r.	o. r.
906507	300 - -	240	34 / 28	21,5	23,3	134,0	290,0	5	o. r.	o. r.	o. r.
906508	300 - -	300	34 / 32	24,5	23,3	144,0	349,0	5	o. r.	o. r.	o. r.

Continuation ►

HELU-S-PV-AL/CU Aluminium / Copper press connector

Bare

Part no.	Cross-section AL RM/SM - SE mm ²	Cross-section CU SE mm ²	Code type AL / CU	d1 CU mm	d2 AL mm	l mm	Weight kg / 1000 items	Unit	Net EUR/100 items at a purchase of		
									up to 100	101 - 500	501 - 1000
906509	400 - -	185	38 / 25	19,0	26,0	131,0	267,0	1	o. r.	o. r.	o. r.
906210	400 - -	240	38 / 28	21,5	26,0	135,0	329,0	1	o. r.	o. r.	o. r.
906510	400 - -	300	38 / 32	24,5	26,0	145,0	386,0	1	o. r.	o. r.	o. r.
907860	500 - -	240	44 / 28	21,5	29,0	145,0	402,0	1	o. r.	o. r.	o. r.
907861	500 - -	300	44 / 32	24,5	29,0	155,0	464,1	1	o. r.	o. r.	o. r.
907862	500 - -	400	44 / 38	27,5	29,0	173,0	643,6	1	o. r.	o. r.	o. r.

Dimensions and specifications may be changed without prior notice.

o. r. = on request



HELUTOOL 250 pocket

Multistrip 10

Außenmantelschneider HAMX

Fasenschneider HUF5

Kabelmesser HKM 1

Series/Material	Application area	Item	page
Cable shear			
Cable shear		HELUTOOL HKS 1 Cable shear	426
Cable shear		HELUTOOL HKS 35 Cable shear	427
Cable shear		HELUTOOL D20 Cable shear	428
Cable shear		HELUTOOL HKS 32 Cable shear	429
Cable cutter		HELUTOOL HKS 34 S Cable cutter	430
Cable shear		HELUTOOL HKS 52 S Cable shear	431
Electricians scissors	for screened and unscreened cables	Electricians scissors for screened cables and wires	432
Cable stripping knife		HELUTOOL HKM1 Cable knife	433
Dismantling/Stripping			
Stripping knife		Jokari Stripping knife	434
Stripping knife		Jokari with hook stripping knife	435
Stripping knife		Jokari round Stripping knife	436
Dismantling tool		HELUTOOL HAM 1	437
Processing tool	for core end sleeves	Stripax-Plus	438
Wire stripper		High Strip	439
Wire stripper		Multistrip 10	440
Dismantling and stripping		Duo Stripper 200	441
Stripping, Crimping and Shearing		Duo Crimp 300	442
Crimping/Pressing			
Crimping tool		HELUTOOL PEW 8.84 Crimping tool	443
Pliers		803/0, 803/5, 804 Pliers	444
Pliers		802/0 Pliers	445
Pliers		802/1 Pliers	446
Pliers		DEB 0560 Pliers	447
Pliers		HELUTOOL HWZ 6 Pliers	448
Pliers		806/0, 806/4, 806/8 Pliers	449
Pliers		807/1, 807/2 Pliers	450
Pliers		K05 Pliers	451
Pliers		K06 Pliers	452
Pliers		K25 Pliers	453
Pliers		HELUTOOL HWW 6/50 Pliers	454
Pliers		HELUTOOL HWW 10/120 Pliers	455
Mechanical hand compression tool		HELUTOOL HMPI 20	456
Hydraulic hand compression tool		HELUTOOL HHPI 20	457
Battery hydraulic tool in toolbox		HAP 60-2	458
Inserts WM-shape		HELU-S-PE-WM	459
Inserts hexagonal shape		HELU-S-PE-SK	460
Compression tool		ERG 740 Compression tool	461
Tool inserts		ERG 740 Tool inserts	462
Fastening			
Box spanners		ST Box spanners	463
Installation tool		HELUTOOL MZ installation tool	464
Cable tie tools			
Circlip pliers	for cable ties made of plastic	ERG 50, ERG 120 circlip pliers	465
Circlip pliers	for cable ties made of stainless steel	CT5 circlip pliers	466
Handling			
Screw pliers		HELUTOOL SZ screw pliers	467
Dismantling tool		Dismantling tool HAM 1	468
Outer sheath cutter		Outside cleading cutter HAMX	469
Cable stripper	for vulcanized semi conductive layer	Cable stripper HFBS	470
Inner sheath cutter		Inner sheath cutter (universal) HIMS II	471
Fiber cutter		Chamfer cutter HUF5	472
Cable stripping knife		Cable knife HKM 1	473
Complete dismantling set		M5-skinning complete set	474
Cable reel drum		HELUTOOL 250 pocket, 190 cable reel drum	475
Drum unwinder		TROMBOI 500 drum unwinder	476
Drum unwinder		TROMBOI 800 / TROMBOI 1400 drum unwinder	474
Drum unwinder		TROMBOI 7-10 / TROMBOI 9-14 drum unwinder	478
Drum unwinder		TROMBOI 2003 drum unwinder	479
Drum unwinder, movable		TROMCAR 1000 / TROMCAR 1250 movable drum unwinder	480
Drum unwinder, movable		TROMTRAK 1250 movable drum unwinder	481
Longimetry devices		MESSBOI	482
Mounting			
Cable grips		Cable grips	483
Cable fleeting grips		Cable fleeting grips	484
Cable installation grips		Cable installation grips	485

HELUTOOL HKS 1 Cable shear



Cable shear HELUTOOL HKS 1

High quality cable shear for cutting finewire stranded Cu- /Al-wires

- Blade made of special stainless steel according to EN10020
- Ergonomical and extremely robust
- High cutting performance
- Loose-free screw/pin fixing
- 2-component-handles
- With special safety box
- Cutting area:
 - Straight blade area 0,5-6mm²
 - Integrated cable cutter up to 50mm²
- Length: 150mm
- Weight: 0,17g

Scope of delivery

Cable shear HKS 1, Safetybox

Part no.	Type	Unit	Net EUR/ item at a purchase of		
			1	2 - 4	5 - 10
908229	HKS 1	1	o. r.	o. r.	o. r.

Dimensions and specifications may be changed without prior notice.

o. r. = on request

HELUTOOL HKS 35 Cable shear



Cable shear HELUTOOL HKS 35

High quality forged cable cutter for cutting stranded aluminium and copper cables up to 35mm².

Long life cycle, low efforts during cutting and a clean round cut characterize this cable cutter.

- For cutting cables with outer diameters up to 11mm.
- Forged
- Tempered blade with precise finish
- Burnished
- Plastic coated handle
- Length 165mm
- Weight 200g

Part no.	Type	Unit	Net EUR/item at a purchase of		
			1	2 - 4	5 - 10
907602	HKS 35	1	o. r.	o. r.	o. r.

Dimensions and specifications may be changed without prior notice.

o. r. = on request

HELUTOOL D20 Cable shear



Cable shear HELUTOOL D20

- VDE approved, 1000V
- For cutting copper and aluminium cables, single and multi-core
- Low handforce required due to favourable lever ratio and special blade geometry
- Clean and smooth cut without crushing and deformation
- Initial and final cut (upper and lower blade)
- Allows cables of up to 20 mm dia. to be cut
- With guard
- Handles plastic coated
- Precision ground , hardened blades
- Adjustable bolted joint, self-retaining screw
- High-grade special tool steel, forged, oil-hardened
- Length 200 mm
- Weight 340 g

Part no.	Type	Unit	Net EUR/item at a purchase of		
			1	2 - 4	5 - 10
904933	HELUTOOL D20	1	o. r.	o. r.	o. r.

Dimensions and specifications may be changed without prior notice.

o. r. = on request

HELUTOOL HKS 32 Cable shear



Cable shear HKS 32

- For cutting stranded Al- and Cu-cables, single and multi-core
- Cutting ranges up to 32mm
- The cutting blades consist of a hardened special tool steel
- Length 600 mm
- Weight 1500 g

Note

Not applicable for cutting steelwires, cables with steel-insertion and solid conductors.

Part no.	Type	Unit	Net EUR/item at a purchase of		
			1	2 - 4	5 - 10
907603	HKS 32	1	o. r.	o. r.	o. r.

Dimensions and specifications may be changed without prior notice.

o. r. = on request

HELUTOOL HKS 34 S Cable cutter



Cable Cutter HKS 34 S

Very robust and smooth running cable cutter for cutting stranded aluminium and copper cables.

- Up to 4x70mm² approx. 1x185mm²
- For finewiring conductors up to 34mm outer-diameter
- Double needle beared and excentric drive combined with a special blade design guarantees the excellent efficiency of this cable cutter
- Length: 250mm
- Weight: 0,9kg

Note

Not applicable for cutting steel-wires, cables with steel-insertion and solid conductors.

Part no.	Type	Unit	Net EUR/ item at a purchase of		
			1	2 - 4	5 - 10
908053	HKS 34 S	1	o. r.	o. r.	o. r.

Dimensions and specifications may be changed without prior notice.

o. r. = on request

HELUTOOL HKS 52 S Cable shear



Cable cutter HKS 52 S

Very robust and smooth running cable cutter for cutting stranded aluminium and copper cables.

- Up to 4x120mm² approx. 1x300mm² and finewiring conductors up to 52mm outside-diameter
- Double, needle bared and patented eccentric drive combined with a special blade design guarantees the excellent efficiency of this cable cutter.
- Length: 325mm
- Weight: 1,2kg

Note

Not applicable for cutting steel-wires, cables with steel-insertion and solid conductors.

Part no.	Type	Unit	Net EUR/item at a purchase of		
			1	2 - 4	5 - 10
907605	HKS 52 S	1	o. r.	o. r.	o. r.

Dimensions and specifications may be changed without prior notice.

o. r. = on request

Electricians scissors For screened cables and wires



Electricians scissors

- Cuts copper braid shielded cables and wires
- Clean cut with serrated edge
- With round wire cutter
- Very stable version
- Cut from special stainless steel, nickel plated
- Handy
- Length 125 mm
- Weight 65 g

Electricians scissors

Part no.	Type	Unit	Net EUR/item at a purchase of		
			1	2 - 4	5 - 10
905120	Electricians scissors	1	o. r.	o. r.	o. r.

Dimensions and specifications may be changed without prior notice.

o. r. = on request

HELUTOOL HKM 1 Cable stripping knife



Cable stripping knife HKM 1

- With special grinding. The special blade prevented a damage of the conductor. The knife has a blade protection, sinking into the handle
- The changeable blade is made of stainless steel according to DIN EN 10020, hardness minimum 50 HRC
- High-quality, ergonomically formed handle is out of impact plastic (PA)
- Admission of the VDE up to 1000 volt according to EN/IEC 60900:2004 and GS-sign
- Length: 200 mm
- Weight: 0,1 kg

Note

Spare blade with moulded plastic insert for HKM 1, part no. 906246

Cable stripping knife HKM 1

Part no.	Type	Cross-section mm ²	Unit	Net EUR/item at a purchase of		
				1	2 - 4	5 - 10
906245	HKM 1	-	1	o. r.	o. r.	o. r.

Dimensions and specifications may be changed without prior notice.

o. r. = on request

Jokari Stripping knife



Jokari stripping knife

- For small and large cable diameters

Stripping knife

Part no.	Type	Diameter from - to mm	Unit	Net EUR/item at a purchase of		
				1	2 - 4	5 - 10
98718	J 16	4,0 - 16,0	1	o. r.	o. r.	o. r.
98719	J 27	8,0 - 28,0	1	o. r.	o. r.	o. r.
98720	J 35	27,0 - 35,0	1	o. r.	o. r.	o. r.
98721	J 50	35,0 - 50,0	1	o. r.	o. r.	o. r.

Dimensions and specifications may be changed without prior notice.

o. r. = on request

Jokari with hook Stripping knife



Jokari stripping knife

- Practical hook knife for peeling all standard round cables.

Stripping knife

Part no.	Type	Diameter from - to mm	Unit	Net EUR/item at a purchase of		
				1	2 - 4	5 - 10
98303	J 28 H	8,0 - 28,0	1	o. r.	o. r.	o. r.

Dimensions and specifications may be changed without prior notice.

o. r. = on request

Jokari round stripping knife



Jokari round stripping knife

Practical and handy knife for peeling all standard round cables.

- **J15** for peeling and stripping (0.2-4.0mm²) with integrated slide-out blade.
- **J12** for peeling.

Stripping knife

Part no.	Type	Diameter from - to mm	Unit	Net EUR/item at a purchase of		
				1	2 - 4	5 - 10
98716	J 15	8,0 - 13,0	1	o. r.	o. r.	o. r.
98717	J 12	8,0 - 13,0	1	o. r.	o. r.	o. r.

Dimensions and specifications may be changed without prior notice.

o. r. = on request

HELUTOOL HAM 1 Skinning tool

For round cables



Skinning tool HAM 1

- For PVC-insulated round cables and a plurality of PUR-insulated cables up to 25mm Ø.
- Suitable for longitudinal and round section. The depth of the cut is adjustable from 0 to 5mm. The cutting blade can be used double-sided.
- Length: 50 mm
- Weight: 0,16 kg

Note

Replacement cutting blade for HAM 1, Part 906234

Scope of delivery

HAM 1 incl. plastic box

Skinning tool HAM 1

Part no.	Type	Cross-section mm ²	Unit	Net EUR/item at a purchase of		
				1	2 - 4	5 - 10
906233	HAM1	-	1	o. r.	o. r.	o. r.

Dimensions and specifications may be changed without prior notice.

o. r. = on request

Stripax-Plus Processing tool for core end sleeves



Stripax - Plus

- Processing tool for core end sleeves in strip format.
- Universal tool for cutting, stripping and crimping.
- Crimping to DIN 46228
- Length 210 mm
- Weight 260 g

Processing tool for core end sleeves

Part no.	Type	Cross-section min. - max. mm ²	Unit	Net EUR/ item at a purchase of		
				1	2 - 4	5 - 10
91923	Stripax-Plus	0,5 - 2,5	1	o. r.	o. r.	o. r.

Dimensions and specifications may be changed without prior notice.

o. r. = on request

High Strip Stripper



High Strip wire strippers

- Automatic wire strippers for conductors with problematic insulation, e.g.: Silicone, rubber, TPE.

Stripper

Part no.	Type	Cross-section min. - max. mm ²	Unit	Net EUR/item at a purchase of		
				1	2 - 4	5 - 10
98448	High Strip	0,5 - 4,0	1	o. r.	o. r.	o. r.

Dimensions and specifications may be changed without prior notice.

o. r. = on request

Multistrip 10 Stripper



Stripper Multistrip 10

- Self adjusting
- For single and multi-core lines made of PVC, rubber etc.
- Adjustable stripping length up to 18mm
- Robust metal clamps
- Ergonomic two-component handle
- Length 195 mm
- Weight 200 g

Stripper

Part no.	Type	Cross-section min. - max. mm ²	Unit	Net EUR/item at a purchase of		
				1	2 - 4	5 - 10
904731	Multistrip 10	0,03 - 10,0	1	o. r.	o. r.	o. r.

Dimensions and specifications may be changed without prior notice.

o. r. = on request

DUO Stripper 200 Peeling and stripping



Duo Stripper 200

The Duo Stripper 200, one tool with 2 functions:
Peeling and stripping.

- Peels all standard round cables from 4-28mm, with adjustable cutting depth and rotating knife for automatic conversion from round to longitudinal sections.
- Stripping from 0.5 to 6.0mm².

Peeling and stripping

Part no.	Type	Unit	Net EUR/item at a purchase of		
			1	2 - 4	5 - 10
91924	DUO 200	1	o. r.	o. r.	o. r.

Dimensions and specifications may be changed without prior notice.

o. r. = on request

DUO Crimp 300 Stripping, crimping, shearing

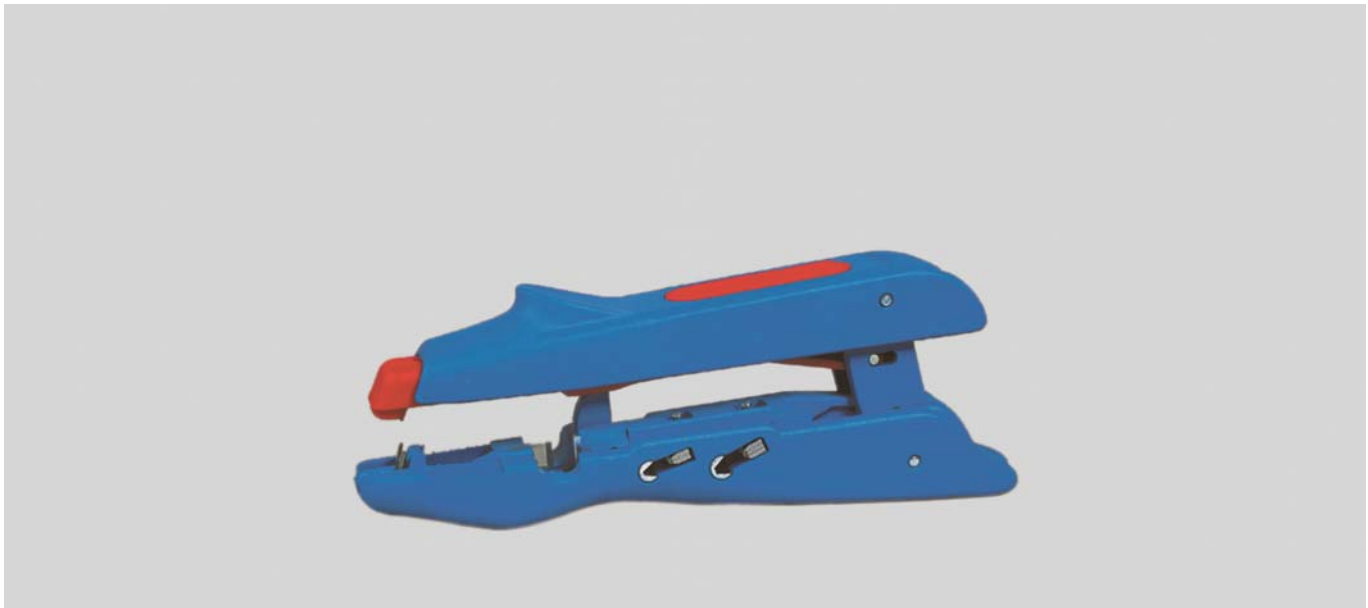

DUO Crimp 300

The Duo Crimp 300, one tool with 3 functions:
Stripping, crimping, shearing.

- Stripping from 0.5 to 6.0mm².
- Crimping in 2 clamping ranges (0.5 to 2.5mm² and 4,0 to 6.0mm²)
- Shearing with integrated side cutter

Stripping, crimping, shearing

Part no.	Type	Unit	Net EUR/item at a purchase of		
			1	2 - 4	5 - 10
97388	DUO-Crimp 300	1	o. r.	o. r.	o. r.

Dimensions and specifications may be changed without prior notice.

o. r. = on request

HELUTOOL PEW 8.84 Crimping tool



Crimping tool HELUTOOL PEW 8.84

- Burnished
- Square crimp profile realized by synchronously driven crimp jaws
- 4 serrated crimp surfaces
- Ergonomic two-component handle
- Length 180mm
- Weight 380g

Crimping tool

Part no.	Type	Cross-section min. - max. mm ²	Unit	Net EUR/item at a purchase of		
				1	2 - 4	5 - 10
903624	HELUTOOL PEW 8.84	0,08 - 10,0	1	o. r.	o. r.	o. r.

Dimensions and specifications may be changed without prior notice.

o. r. = on request

803/0, 803/5, 804 Pliers



Crimping pliers type 803/0; 803/5; 804

Type 803 crimping pliers for core end sleeves to DIN 46228 in cross-section 0.25 to 6.0mm².

Type 804 for core end sleeves to DIN 46228 and tubular lugs.

- Cross-section for core end sleeves 0.75 to 16.0mm².
- Cross-section for tubular lugs 0.75 to 2.5mm².

Pliers

Part no.	Type	Cross-section min. - max. mm ²	Unit	Net EUR/item at a purchase of		
				1	2 - 4	5 - 10
91602	803/0	0,25 - 2,5	1	o. r.	o. r.	o. r.
91603	803/5	1,5 - 6,0	1	o. r.	o. r.	o. r.
91601	804	0,5 - 16,0	1	o. r.	o. r.	o. r.

Dimensions and specifications may be changed without prior notice.

o. r. = on request

802/0 Pliers



Jointing clamp type 802/0

For insulated cable lug, with positive lock.
Clamping range 0.5 to 6.0mm².

Pliers

Part no.	Type	Cross-section min. - max. mm ²	Unit	Net EUR/item at a purchase of		
				1	2 - 4	5 - 10
91612	802/0	0,5 - 6,0	1	o. r.	o. r.	o. r.

Dimensions and specifications may be changed without prior notice.

o. r. = on request

802/1 Pliers



Jointing clamp type 802/1

For insulated cable lugs, with positive lock and mechanism for reducing the hand force by 50% to 250N.
(Durable life, min. 50,000 clampings).
Clamping range 0.5 to 6.0mm².

Pliers						
Part no.	Type	Cross-section min. - max. mm ²	Unit	Net EUR/item at a purchase of		
				1	2 - 4	5 - 10
91163	802/1	0,5 - 6,0	1	o. r.	o. r.	o. r.

Dimensions and specifications may be changed without prior notice.

o. r. = on request

DEB 0560 Pliers



Joining clamp type DEB 0560

For insulated and non-insulated core end sleeves,
for completely safe clamping with positive lock.
Clamping range 0.5 to 6.0mm².

Pliers

Part no.	Type	Cross-section min. - max. mm ²	Unit	Net EUR/item at a purchase of		
				1	2 - 4	5 - 10
97343	DEB 0560	0,5 - 6,0	1	o. r.	o. r.	o. r.

Dimensions and specifications may be changed without prior notice.

o. r. = on request

HELUTOOL HWZ 6 Crimping tool



Crimping tool HWZ 6

Crimping tool for noninsulated terminals from 0,5 up to 16mm². The ratchet guarantees a permanent high quality crimping result.

- Length: 240 mm
- Weight: 0,4 kg

Part no.	Type	Cross-section min. - max. mm ²	Unit	Net EUR/item at a purchase of		
				1	2 - 4	5 - 10
907611	HWZ 6	0,5 - 16,0	1	o. r.	o. r.	o. r.

Dimensions and specifications may be changed without prior notice.

o. r. = on request

806/0, 806/4, 806/8 Pliers



Crimping pliers type 806/0, 806/4 and 806/8

For non-insulated terminal lugs (standard design) with rotating profile disk, arbour clamping.

Pliers

Part no.	Type	Cross-section min. - max. mm ²	Unit	Net EUR/item at a purchase of		
				1	2 - 4	5 - 10
91607	806/0	6,0 - 50,0	1	o. r.	o. r.	o. r.
91616	806/4	50,0 - 120,0	1	o. r.	o. r.	o. r.
91618	806/8	120,0 - 240,0	1	o. r.	o. r.	o. r.

Dimensions and specifications may be changed without prior notice.

o. r. = on request

807/1, 807/2 Pliers



Jointing clamps type 807/1; 807/2

For non-insulated tubular lugs (standard design)
with rotating profile disk, hexagonal clamping.

Part no.	Type	Cross-section min. - max. mm ²	Unit	Net EUR/item at a purchase of		
				1	2 - 4	5 - 10
91610	807/1	6,0 - 50,0	1	o. r.	o. r.	o. r.
91611	807/2	10,0 - 120,0	1	o. r.	o. r.	o. r.

Dimensions and specifications may be changed without prior notice.

o. r. = on request

K05 Pliers



Pliers K05

For terminal lugs and connection sleeves in standard design

- Hexagonal crimping profile, fixed in revolving profile
- Length 390mm
- Weight 1,1kg

Pliers

Part no.	Type	Cross-section min. - max. mm ²	Unit	Net EUR/item at a purchase of		
				1	2 - 4	5 - 10
904734	K05	6,0 - 50,0	1	o. r.	o. r.	o. r.

Dimensions and specifications may be changed without prior notice.

o. r. = on request

K06 Pliers



Pliers K06

For terminal lugs and connection sleeves in standard design

- Hexagonal crimping profile, fixed in revolving profile
- Length 650mm
- Weight 2,9kg

Pliers

Part no.	Type	Cross-section min. - max. mm ²	Unit	Net EUR/item at a purchase of		
				1	2 - 4	5 - 10
904735	K06	10,0 - 120,0	1	o. r.	o. r.	o. r.

Dimensions and specifications may be changed without prior notice.

o. r. = on request

K25 Pliers



Pliers K25

- Indent crimping
- Spring-supported tool opening
- For nickel tubular cable lugs
- Length 325 mm
- Weight 0,6 kg

Pliers

Part no.	Type	Cross-section min. - max. mm ²	Unit	Net EUR/item at a purchase of		
				1	2 - 4	5 - 10
905561	K25	0,5 - 16,0	1	o. r.	o. r.	o. r.

Dimensions and specifications may be changed without prior notice.

o. r. = on request

HELUTOOL HWW 6/50 Crimping tool



Crimping tool HWW 6/50

- Crimping tool for crimping tubular cable lugs and connectors of the HELU-S-RK tubular cable lugs and HELU-S-SV tubular butt connectors - series
- Application range: 6 up to 50mm²
- Cross section can be adjusted by turning the in-built revolving dies
- No need of changing dies
- Tool points by small measurements, light weight and an extremely high crimping quality due to WM-crimping
- Length: 380 mm
- Weight: 1,3 kg

Part no.	Type	Cross-section min. - max. mm ²	Unit	Net EUR/item at a purchase of		
				1	2 - 4	5 - 10
907612	HWW 6/50	6,0 - 50,0	1	o. r.	o. r.	o. r.

Dimensions and specifications may be changed without prior notice.

o. r. = on request

HELUTOOL HWW 10/120 Crimping tool



HELUTOOL HWW 10/120

- Crimping tool for crimping tubular cable lugs and connectors of the HELU-S-RK tubular cable lugs and HELU-S-SV tubular butt connectors - series
- Application range: 10-120mm²
- The cross section can be adjusted by turning the in-built revolving dies
- No need of changing dies
- Feature: Large processing area, light weight and an extremely high crimping quality due to WM-crimping
- Length: 660 mm
- Weight: 4,1 kg

Part no.	Type	Cross-section min. - max. mm ²	Unit	Net EUR/item at a purchase of		
				1	2 - 4	5 - 10
907613	HWW 10/120	10,0 - 120,0	1	o. r.	o. r.	o. r.

Dimensions and specifications may be changed without prior notice.

o. r. = on request

HELUTOOL HMPI 20 Mechanical hand press in toolbox



HELUTOOL HMPI20 Hand-operated mechanical compression tool in toolbox

Hand-operated mechanical compression tool for crimping cable lugs and connectors up to 300mm²

- Light and compactly construction form
- Universal usage: dies for all versions of cable lugs are available
- 360° revolving head with quick opening and closing
- Continuous moveable telescopic handle
- Press force: approx. 60 kN
- Length: 560 up to 830 mm
- Weight: 3,6 kg

Note

Exclusive inserts

Matching inserts:
HELU-S-PE-SK and HELU-S-PE-WM
Further inserts available on request

Scope of delivery

Including plastic toolbox

Part no.	Type	Cross-section min. - max. mm ²	Unit	Net EUR/item at a purchase of		
				1	2 - 4	5 - 10
907614	HMPI 20	-	1	o. r.	o. r.	o. r.

Dimensions and specifications may be changed without prior notice.

o. r. = on request

HELUTOOL HHPI 20 Hydraulic hand press in toolbox



HELUTOOL HHPI 20 Hydraulic hand press in toolbox

- Extremely fast operation through two-stage hydraulic pump
- Large processing area up to 300mm²
- Rotatable quick release head 180 °
- With folding clasp for effortless operation even in hard reach places
- Lightweight and portable, compact design
- Built-in pressure relief valve, even in the case of a false pressing no damage to the tool and inserts
- Universally applicable: inserts are available for all cable lug types
- Press force: ca. 62kN
- Length: 396 mm
- Weight: ca. 2,8 kg

Note

Exclusive inserts
Matching inserts:
HELU-S-PE-SK and HELU-S-PE-WM
Further inserts available on request

Scope of delivery

Including plastic toolbox

Part no.	Type	Unit	Net EUR/item at a purchase of		
			1	2 - 4	5 - 10
908286	HHPI 20	1	o. r.	o. r.	o. r.

Dimensions and specifications may be changed without prior notice.

o. r. = on request

HELUTOOL HAP 60-2 Battery-powered hydraulic tool in toolbox



HELUTOOL HAP 60-2 Battery hydraulic tool in toolbox

- For processing cable lugs and connectors up to 300mm²
- Quick infeed due to double piston hydraulic system
- Variable speed for placing the tool
- Ergonomic design for effortless work
- Easy to service and compact design
- Two-piece component handles with optimal weight distribution
- Powerful Li-Ion battery 18 V
- LED to illumination of the workspace
- Crimping area: 6 - 300 mm²
- Press force: ca. 60 kN
- Head rotation: 360°
- Opening range: 17 mm
- Battery voltage: 18 V
- Weight incl. battery: approx. 4,4 kg
- Tool dimensions: 330 x 331 x 75 mm

Note

Exclusive inserts

Matching inserts:
HELU-S-PE-SK and HELU-S-PE-WM
Further inserts available on request

Scope of delivery

- Battery-powered hydraulic tool
- Battery
- Battery charger
- Carry strap
- Manual
- Transport case

Part no.	Type	Unit	Net EUR/item at a purchase of		
			1	2 - 4	5 - 10
908494	HAP 60-2	1	o. r.	o. r.	o. r.

Dimensions and specifications may be changed without prior notice.

o. r. = on request

HELU-S-PE-WM Inserts WM-shape

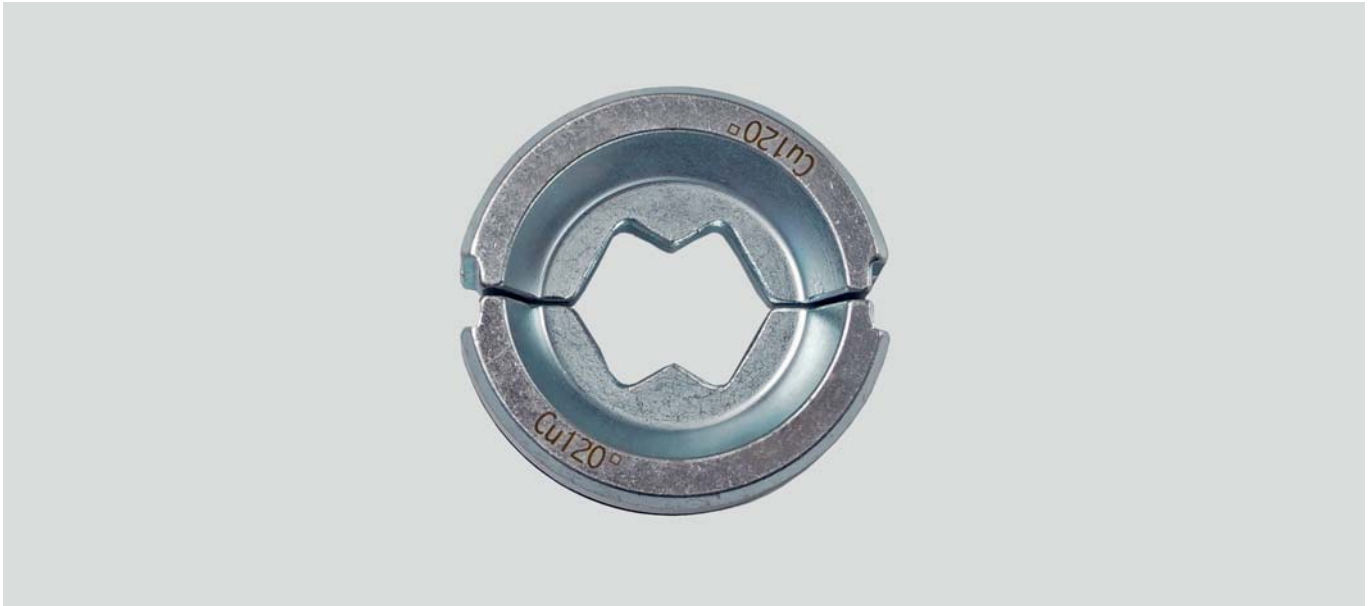

Dies for cable lugs and connectors

For crimping cable lugs and connectors of the HELU-S-RK-CU and HELU-S-SV-CU series

Note

Suitable for:
HELUTOOL HMPI 20, HHPI 20 and HAP 60-2

Inserts R22

Part no.	Type	Cross-section mm ²	Unit	Net EUR/item at a purchase of		
				1	2 - 4	5 - 10
908230	WMCU6	6,0	1	o. r.	o. r.	o. r.
908231	WMCU10	10,0	1	o. r.	o. r.	o. r.
908232	WMCU16	16,0	1	o. r.	o. r.	o. r.
908233	WMCU25	25,0	1	o. r.	o. r.	o. r.
908234	WMCU35	35,0	1	o. r.	o. r.	o. r.
907615	WMCU50	50,0	1	o. r.	o. r.	o. r.
907616	WMCU70	70,0	1	o. r.	o. r.	o. r.
907617	WMCU95	95,0	1	o. r.	o. r.	o. r.
907618	WMCU120	120,0	1	o. r.	o. r.	o. r.
907619	WMCU150	150,0	1	o. r.	o. r.	o. r.
907620	WMCU185	185,0	1	o. r.	o. r.	o. r.
907621	WMCU240	240,0	1	o. r.	o. r.	o. r.
907622	WMCU300	300,0	1	o. r.	o. r.	o. r.

Dimensions and specifications may be changed without prior notice.

o. r. = on request

HELU-S-PE-SK Inserts hexagonal shape



Inserts for cable lugs and connectors

For processing HELU-S-PK compression cable lugs and HELU-S-PV tubular compression joints

Note

Suitable for:
HELUTOOL HMPI 20, HHPI 20 and HAP 60-2

Inserts

Part no.	Type	Code type	Cu mm ²	Al mm ²	Unit	Net EUR/item at a purchase of		
						1	2 - 4	5 - 10
908273	SKCU6	5	6	-	1	o. r.	o. r.	o. r.
908274	SKCU10	6	10	-	1	o. r.	o. r.	o. r.
908275	SKCU16	8	16	-	1	o. r.	o. r.	o. r.
908276	SKCU25AL10	10	25	10	1	o. r.	o. r.	o. r.
908277	SKCU35AL16/25	12	35	16 + 25	1	o. r.	o. r.	o. r.
908278	SKCU50AL35	14	50	35	1	o. r.	o. r.	o. r.
908279	SKCU70AL50	16	70	50	1	o. r.	o. r.	o. r.
908280	SKCU95AL70	18	95	70	1	o. r.	o. r.	o. r.
908281	SKCU120	20	120	-	1	o. r.	o. r.	o. r.
908282	SKCU150AL95/120	22	150	95 + 120	1	o. r.	o. r.	o. r.
908283	SKCU185AL150	25	185	150	1	o. r.	o. r.	o. r.
908284	SKCU240AL185	28	240	185	1	o. r.	o. r.	o. r.
908285	SKCU300AL240	32	300	240	1	o. r.	o. r.	o. r.

Dimensions and specifications may be changed without prior notice.

o. r. = on request

ERG 740 Compression tool



ERG 740 hand compression tool

Hand compression tool suitable for clamping Shield-Kon connectors.
Processing range for single-piece Shield-Kon connectors from 1.27 to 7.62mm.

Note

Shield-Kon connectors see chapter core end sleeves and cable lugs

Compression tool

Part no.	Type T & B	Shield Ø mm	Net EUR/item at a purchase of		
			1	2 - 4	5 - 10
96757	ERG 740	7,62	o. r.	o. r.	o. r.

Dimensions and specifications may be changed without prior notice.

o. r. = on request

ERG 740 Tool inserts



Tool inserts for ERG 740

The tool inserts are simple and quick to change by hand.

Note

Shield-Kon connectors see chapter core end sleeves and cable lugs

Tool inserts

Part no.	Type T & B	Shield Ø mm	Corr. connector	Unit	Net EUR/item at a purchase of		
					1	2 - 4	5 - 10
904774	D-101 A	1,27 - 1,79	RSK 101	1	o. r.	o. r.	o. r.
904775	D-101 B	1,80 - 2,28	RSK 101	1	o. r.	o. r.	o. r.
904776	D-201 C	2,29 - 2,55	RSK 101	1	o. r.	o. r.	o. r.
904777	D-201 D	2,56 - 3,00	RSK 201	1	o. r.	o. r.	o. r.
903718	D-201 E	3,01 - 3,34	RSK 201	1	o. r.	o. r.	o. r.
904778	D-201 F	3,35 - 3,65	RSK 201	1	o. r.	o. r.	o. r.
904779	D-301 G	3,66 - 4,13	RSK 301	1	o. r.	o. r.	o. r.
903735	D-301 H	4,14 - 4,71	RSK 301	1	o. r.	o. r.	o. r.
904692	D-301 J	4,72 - 5,12	RSK 301	1	o. r.	o. r.	o. r.
904780	D-401 K	5,13 - 5,86	RSK 401	1	o. r.	o. r.	o. r.
904693	D-401 L	5,87 - 6,36	RSK 401	1	o. r.	o. r.	o. r.
903731	D-401 M	6,37 - 7,00	RSK 401	1	o. r.	o. r.	o. r.
903685	D-401 N	7,01 - 7,62	RSK 401	1	o. r.	o. r.	o. r.

Dimensions and specifications may be changed without prior notice.

o. r. = on request

ST Box spanners



Socket wrench ST

Special socket wrench, slotted.
For professional installation of glands in extremely restricted spaces.
The guide slot also makes it suitable for glands with integral cables.

Material

Steel
Surface: tinned

Box spanners

Part no.	Spanner size mm	l mm	c mm	D mm	Unit	Net EUR/items at a purchase of		
						1	2 - 4	5 - 10
97356	14,0	60,0	8,5	19,5	1	o. r.	o. r.	o. r.
97535	15,0	60,0	8,5	19,5	1	o. r.	o. r.	o. r.
97536	17,0	60,0	10,0	23,5	1	o. r.	o. r.	o. r.
97148	19,0	60,0	10,0	25,3	1	o. r.	o. r.	o. r.
97537	20,0	60,0	12,0	27,0	1	o. r.	o. r.	o. r.
97149	22,0	60,0	12,0	29,5	1	o. r.	o. r.	o. r.
97538	24,0	60,0	14,0	31,9	1	o. r.	o. r.	o. r.
98726	26,0	60,0	16,0	34,5	1	o. r.	o. r.	o. r.
97417	27,0	60,0	16,0	35,5	1	o. r.	o. r.	o. r.
97539	30,0	60,0	20,0	40,8	1	o. r.	o. r.	o. r.
97150	33,0	60,0	20,0	43,8	1	o. r.	o. r.	o. r.
97540	36,0	60,0	24,0	47,8	1	o. r.	o. r.	o. r.
97541	40,0	100,0	27,0	52,5	1	o. r.	o. r.	o. r.
97542	41,0	100,0	27,0	53,5	1	o. r.	o. r.	o. r.
97151	42,0	100,0	27,0	54,7	1	o. r.	o. r.	o. r.
98727	46,0	100,0	34,0	56,0	1	o. r.	o. r.	o. r.
97543	50,0	100,0	34,0	64,5	1	o. r.	o. r.	o. r.
97152	53,0	100,0	34,0	69,0	1	o. r.	o. r.	o. r.
98728	55,0	100,0	35,0	75,5	1	o. r.	o. r.	o. r.
97544	57,0	100,0	35,0	76,5	1	o. r.	o. r.	o. r.
97545	60,0	100,0	40,0	78,0	1	o. r.	o. r.	o. r.
97546	64,0	100,0	40,0	84,0	1	o. r.	o. r.	o. r.
98729	68,0	100,0	40,0	85,0	1	o. r.	o. r.	o. r.

Dimensions and specifications may be changed without prior notice.

o. r. = on request

HELUTOOL MZ Circlip pliers



HELUTOOL MZ

Assembly pliers for cable glands

- Fast and reliable installation of cable glands
- Automatic progressively adjustable size of the jaw
- Ratchet-like function with pivoting angle 60°
- With fixed adjustment for continuous working
- Good applicable even in constricted working areas
- Stable for professional use
- Extremely handy
- Two-components-plastic handles

Circlip pliers

Part no.	Type	Unit	Net EUR/item at a purchase of		
			1	2 - 4	5 - 10
904892	MZ 13/23	1	o. r.	o. r.	o. r.
904893	MZ 24/36	1	o. r.	o. r.	o. r.

Dimensions and specifications may be changed without prior notice.

o. r. = on request

ERG 50, ERG 120 Circlip pliers for cable ties made of plastic



Assembly tool for plastic cable ties ERG50 / ERG120

Ergonomic hand tool with adjustable tension setting and automatic cutting. 360° degree rotating nose enables operation from any position. An impact damper absorbs the rear shocks, that occur when cutting the tie ends.

- Adjustable tension settings
- Automatic cutting mechanism
- Length 200 mm
- Height 25 mm
- Width 125 mm
- Weight 240 mm

Circlip pliers for cable tie made of plastic

Part no.	Type	Tie width mm	Unit	Net EUR/item at a purchase of		
				1	2 - 4	5 - 10
905663	ERG 50	2,4 - 4,8	1	o. r.	o. r.	o. r.
905849	ERG 120	4,8 - 7,6	1	o. r.	o. r.	o. r.

Dimensions and specifications may be changed without prior notice.

o. r. = on request

CT5 Circlip pliers for cable ties made of stainless steel



Assembly tool CT5 for stainless steel cable ties

- Ergonomic and stable clamping tool by steel for clamping of ball valves and shaped head and steel girders with and without coating, with tape cutter
- Length 210mm

Circlip pliers for cable ties made of stainless steel

Part no.	Type	Tie width mm	Unit	Net EUR/item at a purchase of		
				1	2 - 4	5 - 10
904787	CT5	up to 12,0	1	o. r.	o. r.	o. r.

Dimensions and specifications may be changed without prior notice.

o. r. = on request

HELUTOOL SZ Screw pliers



HELUTOOL SZ

The patented 2-component screw pliers that have been awarded with the Design Prize is the ideal solution for embedded, dirty or corrosion-damaged screws.

In addition, the pliers consist of a single joint with induction hardened precision blade. Arched, horizontally and vertically ridged gripping surface, for all self-tapping or metric screws from M2 to M6.

The special head shape of the pliers securely surrounds the screw head, thus loosening the screw which can no longer be removed with conventional tools.

- Size: 160 mm
- Weight: 140 g
- Handle: 2-component precision blade
- Induction-hardened precision blade with single joint
- Compatible with the screw size M2 to M6

Part no.	Type	Unit	Net EUR/item at a purchase of		
			1	2 - 4	5 - 10
906455	HELUTOOL SZ	1	o. r.	o. r.	o. r.

Dimensions and specifications may be changed without prior notice.

o. r. = on request

HELUTOOL HAM 1 Skinning tool

For round cables



Skinning tool HAM 1

- For PVC-insulated round cables and a plurality of PUR-insulated cables up to 25mm Ø.
- Suitable for longitudinal and round section. The depth of the cut is adjustable from 0 to 5mm. The cutting blade can be used double-sided.
- Length: 50 mm
- Weight: 0,16 kg

Note

Replacement cutting blade for HAM 1, Part 906234

Scope of delivery

HAM 1 incl. plastic box

Skinning tool HAM 1

Part no.	Type	Cross-section mm ²	Unit	Net EUR/item at a purchase of		
				1	2 - 4	5 - 10
906233	HAM1	-	1	o. r.	o. r.	o. r.

Dimensions and specifications may be changed without prior notice.

o. r. = on request

Outside cleading cutter HAMX

With rapid clamping system for low voltage- and medium voltage conductors



Outside cleading cutter HAMX

The outside cleading cutter with rapid clamping system can be used to strip the outer sheath from low voltage and medium voltage conductors with an outside diameter of 16 up to 54 mm.

A switch lever between longitudinal section and round cut as well as an additional claw for breaking the insulation are available. The positioning on the cable is made by a clamping system. The cut depth is adjustable from 0-5 mm in steps of 0,1 mm. The feed rate is made by a ratchet wrench. The maximum rotation diameter is 300 mm.

The components are produced from aluminium and stainless steel. The moldings are made of impact-resistant plastic material. The blades are from alloyed steel according to EN 10020 with a hardness of least 58 HRC.

Weight: 1,32 kg

Note

Spare blade with screw and hex-wrench for HAMX, part no. 906236

Scope of delivery

HAMX-device, ratchet wrench and nylon case

Outside cleading cutter HAMX

Part no.	Type	Cross-section mm ²	Unit	Net EUR/item at a purchase of		
				1	2 - 4	5 - 10
906235	HAMX	-	1	o. r.	o. r.	o. r.

Dimensions and specifications may be changed without prior notice.

o. r. = on request

Cable stripper for vulcanized semi conductive layer HFBS

For stripping the vulcanized semi conductive layer



Cable stripper for vulcanized semi conductive layer HFBS

The device is for stripping the vulcanized semi conductive layer of low voltage and medium voltage conductors. The maximum layer thickness is 1,5 mm. The stripper can be used for insulation diameter of 10 up to 52 mm. The positioning on the cable is made by a clamping system. The stripping process can be started and stopped in every position of the cable. A switch lever to activate/inactivate the axial traverse speed is available. The device has optimum gliding properties through coated contact surfaces. The maximum rotation diameter is 200 mm.

The components are made of aluminium, steel and brass, with anodized, chromium-plated and nickel-plated surfaces. The form parts are of impact resistant plastic. The blades are from alloyed steel with a hardness of least 55 HRC.

Length: 170 mm

Weight: 0,79 kg

Note

- Spare blade 17° for HFBS, part no. 906238
- Spare tube silicone paste 100ml, part no. 906239

Scope of delivery

HFBS-device, silicone paste, allen wrench 2,5 mm, plastic case

Cable stripper for HFBS

Part no.	Type	Cross-section mm ²	Unit	Net EUR/item at a purchase of		
				1	2 - 4	5 - 10
906237	HFBS	-	1	o. r.	o. r.	o. r.

Dimensions and specifications may be changed without prior notice.

o. r. = on request

Inside cleading cutter (universal) HIMS II

For medium voltage conductors



Inside cleading cutter (universal) HIMS II

- The inside cleading cutter HIMS II can be used for stripping-off the primary insulation on the ends of medium voltage conductors of 6 up to 45 kV with outside diameters of 15 up to 52 mm and a maximum insulation thickness of 15 mm.
- The positioning on the cable is made by a clamping system. Spiral and circle cuts are possible. The cut depth is adjustable of 0 up to 15 mm and the feed rate is selectable in 5 steps. The stripping can be stopped in every position of the cable. The stripping length is unlimited. The device has optimum gliding properties through coated contacts surfaces. The maximum rotation diameter is 220 mm.
- The components are made of aluminium, steel and brass, with anodized, chromium-plated and nickel-plated surfaces. The blades are from alloyed steel with a hardness of least 55 HRC.
- Length: 170 mm
- Weight: 1 kg

Note

- Spare blade for HIMS, part no. 906241
- Spare tube silicone paste 100ml, part no. 906239

Scope of delivery

HIMS II device, silicone paste, allen wrench 2,5 mm, plastic case

Inside cleading cutter HIMS II

Part no.	Type	Cross-section mm ²	Unit	Net EUR/item at a purchase of		
				1	2 - 4	5 - 10
906240	HIMS II	-	1	o. r.	o. r.	o. r.

Dimensions and specifications may be changed without prior notice.

o. r. = on request

Chamfer cutter HUFS

For medium voltage conductors



Chamfer cutter HUFS

- Chamfer cutter HUFS is for chamfering the primary insulation of medium voltage conductors with outside diameter from 15 up to 60 mm.
- Positioning on the cable is made by a clamping system. The device has PTFE-plates for optional gliding properties on the cable. A silicone paste is not necessary.
- Size of the chamfer: 2 mm x 60°
- Maximum rotation diameter is 220 mm
- The device is light and has a robust construction form. The components are made of aluminium and steel. The blades are from alloyed steel with a hardness of least 55 HRC.
- Length: 145 mm
- Weight: 0,39 kg

Note

Spare blade for HUFS, part no. 906243

Scope of delivery

HUFS-device, allen wrench 2,5 mm, nylon case

Chamfer cutter HUFS

Part no.	Type	Cross-section mm ²	Unit	Net EUR/item at a purchase of		
				1	2 - 4	5 - 10
906242	HUFS	-	1	o. r.	o. r.	o. r.

Dimensions and specifications may be changed without prior notice.

o. r. = on request

HELUTOOL HKM 1 Cable stripping knife



Cable stripping knife HKM 1

- With special grinding. The special blade prevented a damage of the conductor. The knife has a blade protection, sinking into the handle
- The changeable blade is made of stainless steel according to DIN EN 10020, hardness minimum 50 HRC
- High-quality, ergonomically formed handle is out of impact plastic (PA)
- Admission of the VDE up to 1000 volt according to EN/IEC 60900:2004 and GS-sign
- Length: 200 mm
- Weight: 0,1 kg

Note

Spare blade with moulded plastic insert for HKM 1, part no. 906246

Cable stripping knife HKM 1

Part no.	Type	Cross-section mm ²	Unit	Net EUR/item at a purchase of		
				1	2 - 4	5 - 10
906245	HKM 1	-	1	o. r.	o. r.	o. r.

Dimensions and specifications may be changed without prior notice.

o. r. = on request

MS-Skinning-Complete-Set

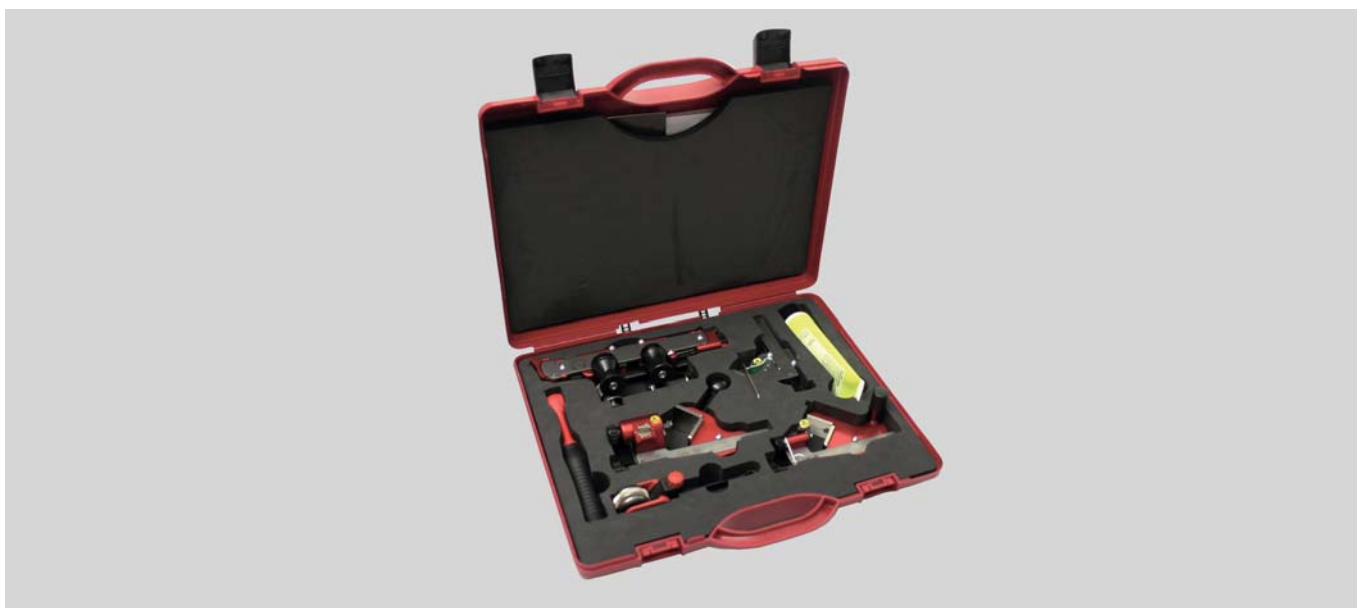

MS-Skinning-Complete-Set

Skinning-Complete-Set for medium voltage cables contains everything you need for stripping.

- Skinning tool HAM1
- Outside cleading cutter HAMX
- Cable stripper for vulcanized semi conductive layer HFBS
- Inside cleading cutter (universal) HIMS II
- Chamfer cutter HUFS
- Spare tube silicone paste
- Dimensions: 38 x 31 x 9 cm
- Weight: 3,73 kg

Part no.	Type	Unit	Net EUR/item at a purchase of 1
906244	MS-Skinning-Complete-Set	1	o. r.

Dimensions and specifications may be changed without prior notice.

o. r. = on request

HELUTOOL 250 pocket, 190 Drum unwinder



Drum unwinder HELUTOOL

For simple reeling of cable drums.

- Dynamic brake for constant traction: retarding effect corresponds to the weight bearing on.
- Small weight
- Small size
- Can be used with broken drums

Drum unwinder

Part no.	Type	Weight app. kg	Load capacity kg	Diameter app. mm	Reel width mm	Unit	Net EUR/item at a purchase of		
							1	2 - 4	5 - 10
903716	HELUTOOL 250 pocket	1,0	190	250	-	1	o. r.	o. r.	o. r.
93529	HELUTOOL 190	7,0	380	500	-	1	o. r.	o. r.	o. r.

Dimensions and specifications may be changed without prior notice.

o. r. = on request

TROMBOI 500 Drum decoiler

Shaftless

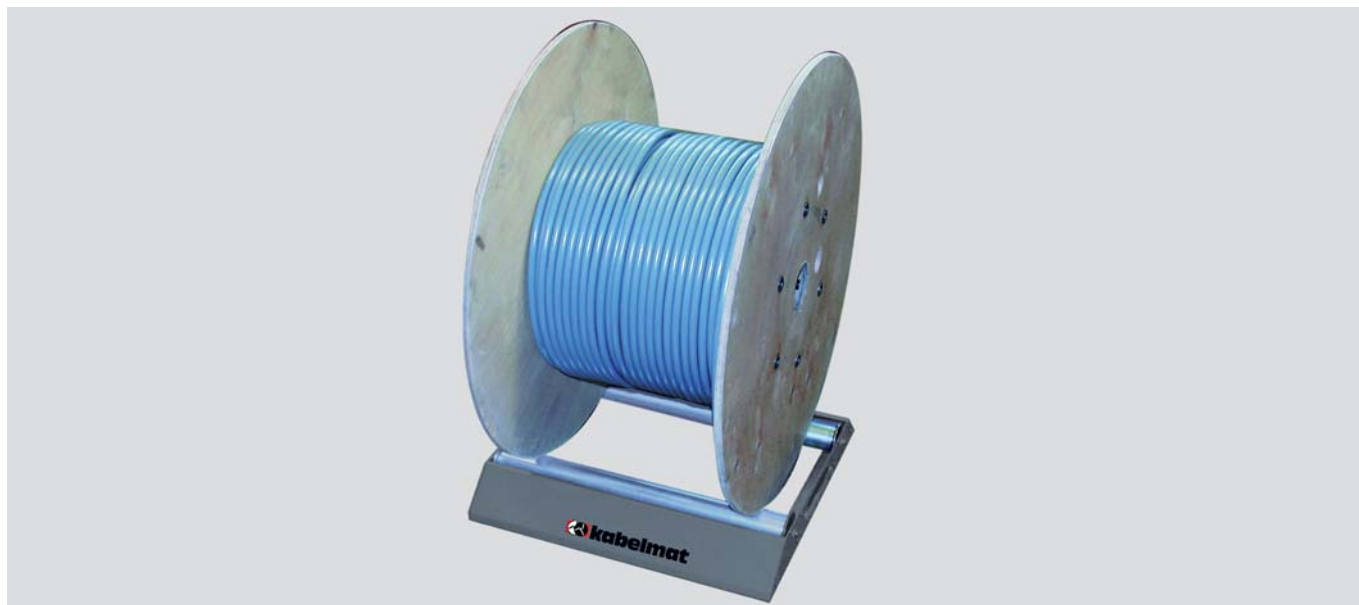

Shaftless drum decoiler TROMBOI 500

For drums with different diameters and weights.

- Solid construction
- Loading ramp
- Sturdy welded steel construction
- Specially suitable for one-way drums
- Ball bearing axles

Drum decoiler

Part no.	Type	Weight app. kg	Load capacity kg	Reel-Ø app. mm	Reel width mm	Unit	Net EUR/item at a purchase of		
							1	2 - 4	5 - 10
904760	TROMBOI 500	8,0	140	150 - 700	520	1	o. r.	o. r.	o. r.
904761	TROMBOI 500 castor (1 set = 4 items)	-	-	-	-	1	o. r.	o. r.	o. r.

Dimensions and specifications may be changed without prior notice.

o. r. = on request

TROMBOI 800 / TROMBOI 1400 Drum decoiler

Shaftless



Shaftless drum decoiler TROMBOI 800 / 1400

For drums for different diameters and weights.

- Compact design
- Loading ramp
- Sturdy welded steel construction
- Specially suitable for one-way drums
- Ball bearing axles

Drum decoiler

Part no.	Type	Weight app. kg	Load capacity kg	Reel-Ø app. mm	Reel width mm	Unit	Net EUR/item at a purchase of		
							1	2 - 4	5 - 10
904762	TROMBOI 800	21,0	500	400 - 1000	580	1	o. r.	o. r.	o. r.
904763	TROMBOI 1400	25,1	1500	500 - 1800	-	1	o. r.	o. r.	o. r.

Dimensions and specifications may be changed without prior notice.

o. r. = on request

TROMBOI 7-10 / TROMBOI 9-14 Drum decoiler

With axis



Drum decoiler with axis TROMBOI 7-10 / 9-14

For drum handling at construction sites, when installing cables, at stock or shipping.

- Solid welded construction
- The sturdy axle holders have to be inserted and locked in a height suitable for the workable drum dimension.
- The drum axle has to be pushed through the drum.
- After having been rolled into the axle holder the drum has to be lifted by means of the manual hydraulic pump.

Note

Additional axis on request

Drum decoiler

Part no.	Type	Weight app. kg	Load capacity kg	Reel-Ø app. mm	Reel width mm	Unit	Net EUR/item at a purchase of		
							1	2 - 4	5 - 10
904764	TROMBOI 7-10	22,5	1000	700 - 1000	-	1	o. r.	o. r.	o. r.
904765	TROMBOI 9-14	41,5	1700	900 - 1400	-	1	o. r.	o. r.	o. r.

Dimensions and specifications may be changed without prior notice.

o. r. = on request

TROMBOI 2003 Drum decoiler

With axis



Drum decoiler with axis TROMBOI 2003

For drum handling at construction sites, when installing cables, at stock or shipping.

- Solid welded construction
- The sturdy axle holders have to be inserted and locked in a height suitable for the workable drum dimension.
- The drum axle has to be pushed through the drum.
- After having been rolled into the axle holder the drum has to be lifted by means of the manual hydraulic pump.

Note

Additional axis on request

Drum decoiler

Part no.	Type	Weight app. kg	Load capacity kg	Reel-Ø app. mm	Reel width mm	Unit	Net EUR/item at a purchase of		
							1	2 - 4	5 - 10
904766	TROMBOI 2003	132,0	4000	710 - 2000	-	1	o. r.	o. r.	o. r.

Dimensions and specifications may be changed without prior notice.

o. r. = on request

TROMCAR 1000 / TROMCAR 1250 Movable drum decoiler

With axis



Movable drum decoiler with axis TROMCAR 1000 / 1250

Application: stock, construction site, installation department etc.

- Moving cable drums with robust lift-up tool.
The drums are lifted and loaded by leverage.
- Lift-up clamp as handle.
- Extra sized wheels.

TROMCAR 1000 with 2 wheels and 2 footholds.

TROMCAR 1250 with 3 wheels.

Movable drum decoiler

Part no.	Type	Weight app. kg	Load capacity kg	Reel-Ø app. mm	Reel width mm	Unit	Net EUR/item at a purchase of		
							1	2 - 4	5 - 10
904767	TROMCAR 1000	50,0	1000	500 - 1000	710	1	o. r.	o. r.	o. r.
904768	TROMCAR 1250	52,0	700	500 - 1250	1000	1	o. r.	o. r.	o. r.

Dimensions and specifications may be changed without prior notice.

o. r. = on request

TROMTRAK 1250 Movable drum decoiler

With axis

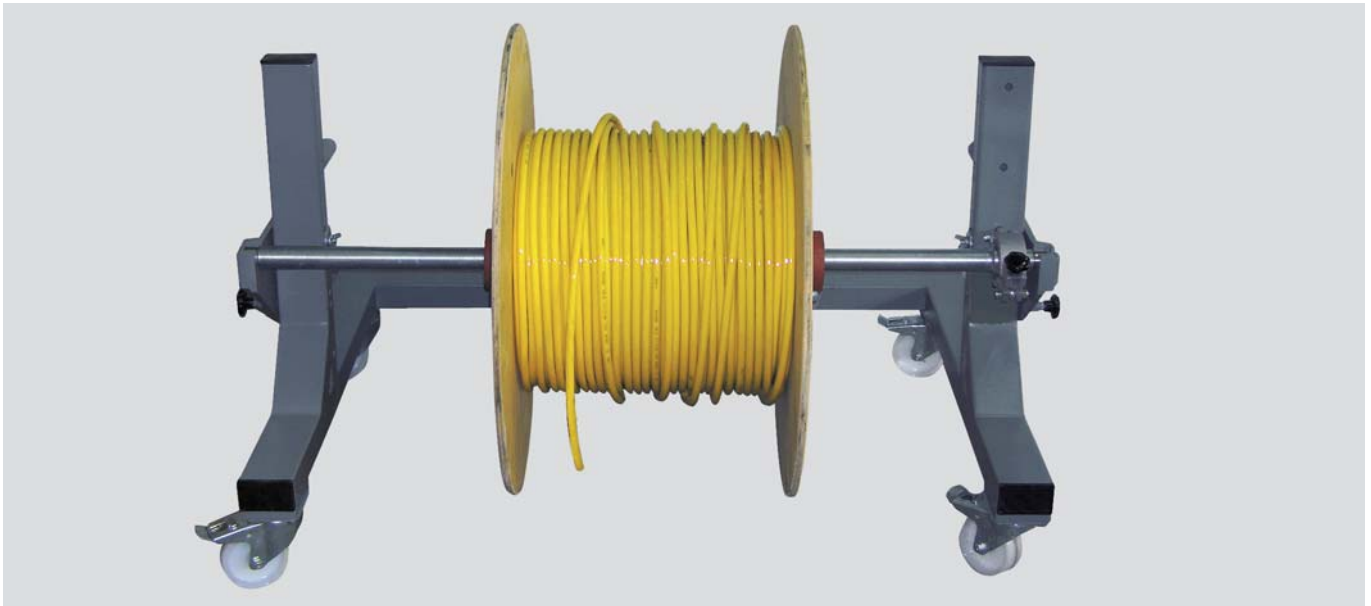

Movable drum decoiler with axis TROMTRAK 1250

For handling of cable drums.

- Two-fold embedded axis.
- Smooth operation by adjustable brake.
- Build-on lockable castors.

Movable drum decoiler

Part no.	Type	Weight app. kg	Load capacity kg	Reel-Ø app. mm	Reel width mm	Unit	Net EUR/item at a purchase of		
							1	2 - 4	5 - 10
904769	TROMTRAK 1250	58,0	1000	630 - 1250	890	1	o. r.	o. r.	o. r.

Dimensions and specifications may be changed without prior notice.

o. r. = on request

MESSBOI Longimetry devices



Longimetry devices MESSBOI M10, MESSBOI M30

To avoid material loss.

- Simple design
- Easy to operate
- Calibration optional
- Counter 9999,99m, with rest button
- Repeat accuracy +/-2%

MESSBOI M10 stationary.

MESSBOI M30 stationary and portable.

Longimetry devices

Part no.	Type	Weight app. kg	Cable Ø app. mm	Unit	Net EUR/item at a purchase of		
					1	2 - 4	5 - 10
97924	MESSBOI M10	0,5	1 - 15	1	o. r.	o. r.	o. r.
97775	MESSBOI M30/012	2,2	1 - 30	1	o. r.	o. r.	o. r.

Dimensions and specifications may be changed without prior notice.

o. r. = on request

Cable grips To tape

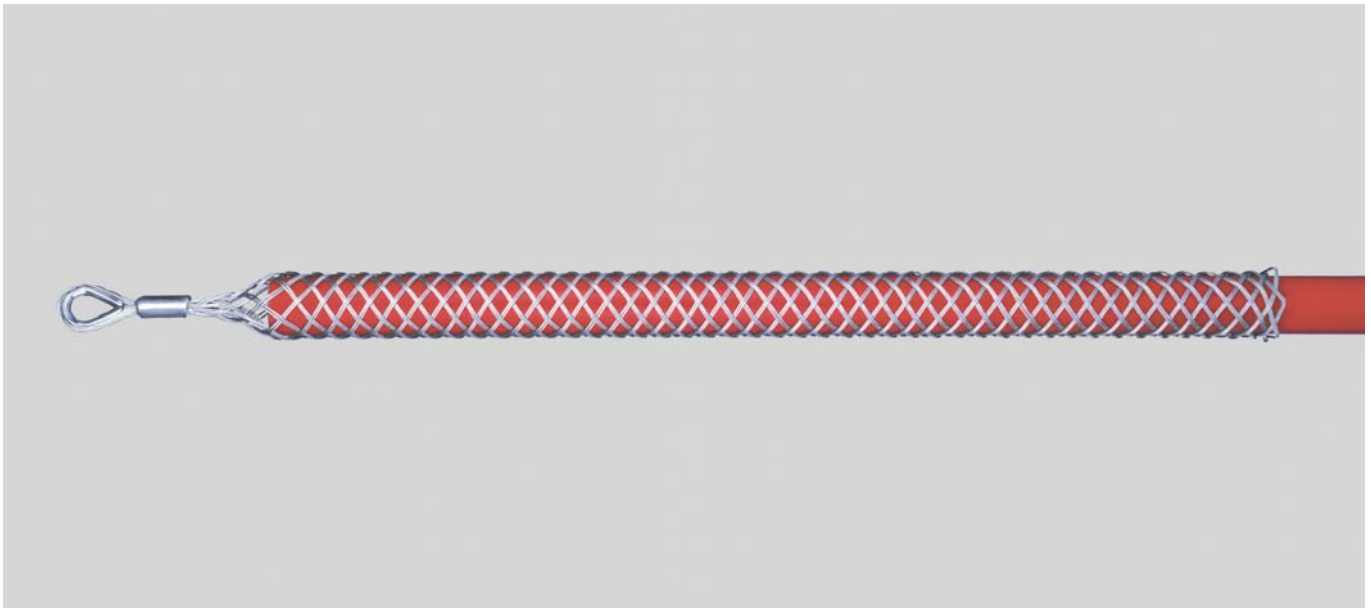

Cable grips with thimble and press clamp, closed

This cable grip is used wherever cables with high tensile forces are routed.

- With thimble and press clamp
- Self-tightening under tension load
- Back-woven

Material

Galvanized steel

Cable grips with thimble

Part no.	Min. inner Ø mm	Max. inner Ø mm	Unit	Net EUR/items at a purchase of		
				1	2 - 4	5 - 10
905891	6,0	10,0	1	o. r.	o. r.	o. r.
905892	10,0	15,0	1	o. r.	o. r.	o. r.
905893	15,0	20,0	1	o. r.	o. r.	o. r.
905375	20,0	25,0	1	o. r.	o. r.	o. r.
905371	30,0	40,0	1	o. r.	o. r.	o. r.
905376	25,0	30,0	1	o. r.	o. r.	o. r.
905894	40,0	50,0	1	o. r.	o. r.	o. r.
905163	50,0	60,0	1	o. r.	o. r.	o. r.
905895	60,0	70,0	1	o. r.	o. r.	o. r.
905896	70,0	90,0	1	o. r.	o. r.	o. r.
905897	90,0	110,0	1	o. r.	o. r.	o. r.

Dimensions and specifications may be changed without prior notice.

o. r. = on request

Cable grips To fleet

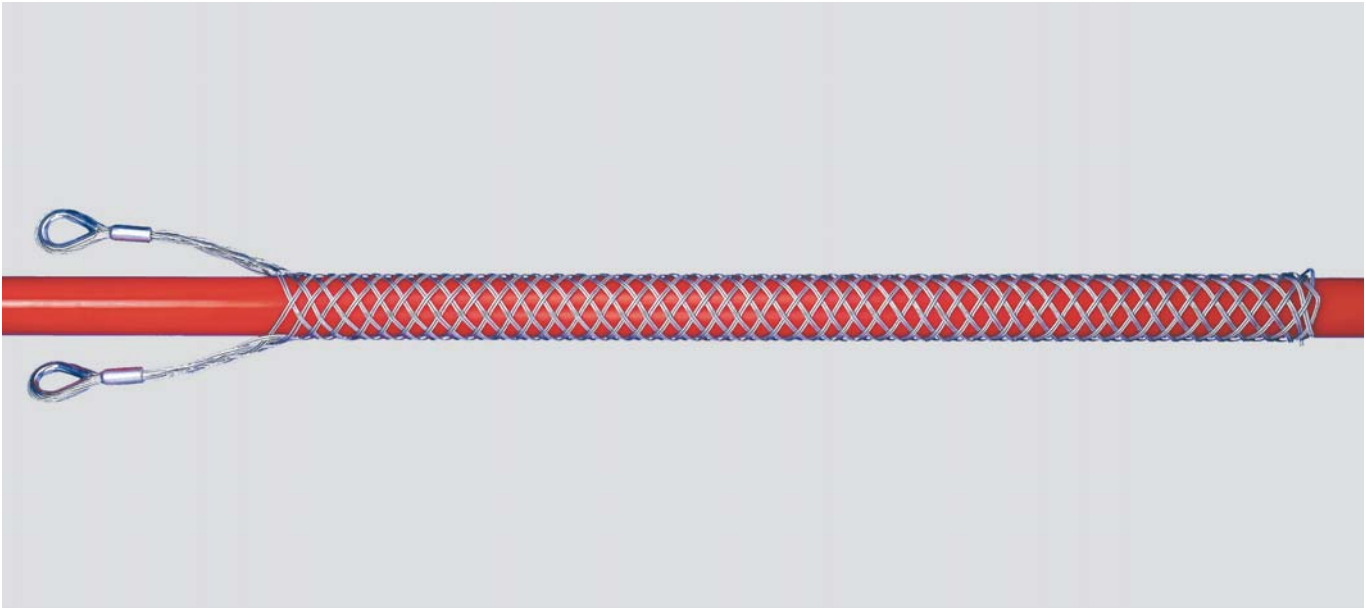

Cable fleeting grips

This cable grip is used as a cable installation grip e.g., wherever cables are suspended vertically. Previously drawn cables can be re-drawn.

- With thimble and press clamp
- Self-tightening under tension load
- Back-woven

Material

Galvanized steel

Cable fleeting grips

Part no.	Min. inner Ø mm	Max. inner Ø mm	Unit	Net EUR/items at a purchase of		
				1	2 - 4	5 - 10
905898	6,0	10,0	1	o. r.	o. r.	o. r.
905899	10,0	15,0	1	o. r.	o. r.	o. r.
905900	15,0	20,0	1	o. r.	o. r.	o. r.
905901	20,0	25,0	1	o. r.	o. r.	o. r.
905902	25,0	30,0	1	o. r.	o. r.	o. r.
905903	30,0	40,0	1	o. r.	o. r.	o. r.
905904	40,0	50,0	1	o. r.	o. r.	o. r.
905905	50,0	60,0	1	o. r.	o. r.	o. r.
905906	60,0	70,0	1	o. r.	o. r.	o. r.
905907	70,0	90,0	1	o. r.	o. r.	o. r.
905908	90,0	110,0	1	o. r.	o. r.	o. r.

Dimensions and specifications may be changed without prior notice.

o. r. = on request

Cable grips To assemble

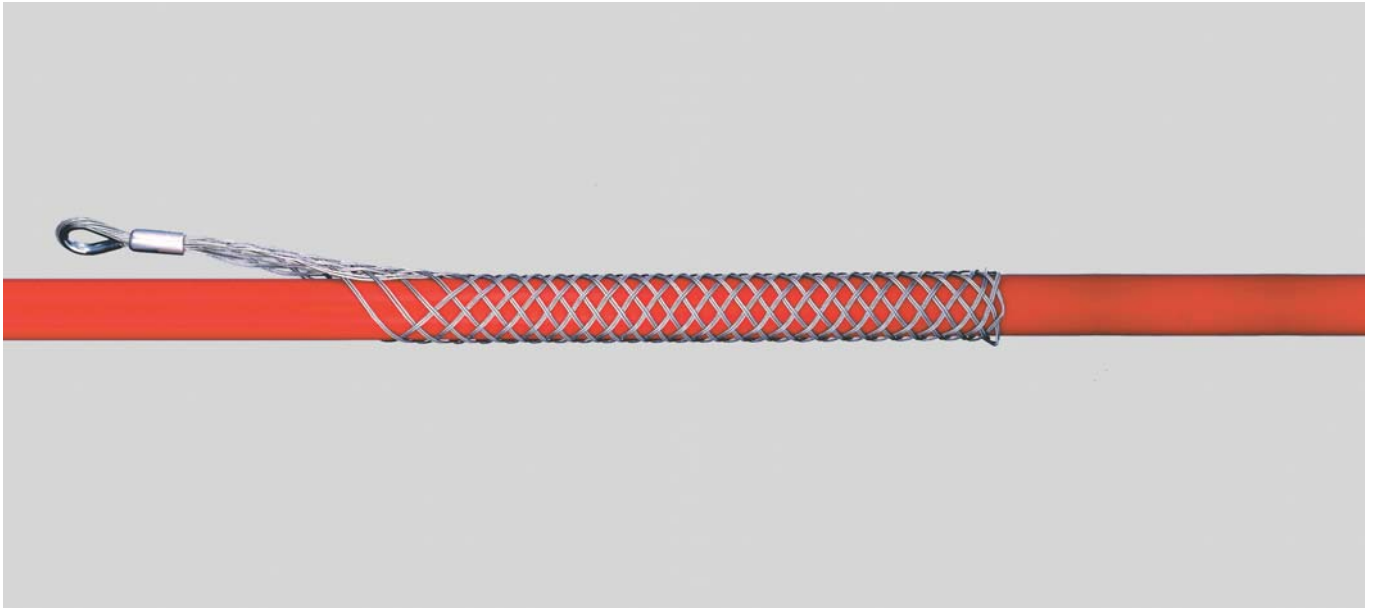

Cable installation grips

Employed as a cable installation grip. For anti-slip installation of vertically attached cables.

- With thimble and press clamp
- Self-tightening under tension load
- Back-woven

Material

Stainless steel 1.4401 / AISI 316

Cable grips

Part no.	Min. inner Ø mm	Max. inner Ø mm	Unit	Net EUR/items at a purchase of		
				1	2 - 4	5 - 10
905909	8,0	10,0	1	o. r.	o. r.	o. r.
905601	10,0	15,0	1	o. r.	o. r.	o. r.
905602	15,0	20,0	1	o. r.	o. r.	o. r.
905603	20,0	25,0	1	o. r.	o. r.	o. r.
905604	25,0	30,0	1	o. r.	o. r.	o. r.
905597	30,0	40,0	1	o. r.	o. r.	o. r.
905605	40,0	50,0	1	o. r.	o. r.	o. r.
905606	50,0	60,0	1	o. r.	o. r.	o. r.
905607	60,0	70,0	1	o. r.	o. r.	o. r.
905918	70,0	90,0	1	o. r.	o. r.	o. r.
905919	90,0	110,0	1	o. r.	o. r.	o. r.

Dimensions and specifications may be changed without prior notice.

o. r. = on request



■ HELUTEC® SIGNAL AND POWER PLUG CONNECTORS

Description	Page
Three technologies for easy handling	488
Functional design for harsh environments	489
HELUTEC®-Series 617 / 623 / 627	490
HELUTEC®-Series 917 / 923 / 932 / 940 / 958	491
HELUTEC®-Series 615 / 915	492
HELUTEC®-Series 926	493
Tools and accessories	494
Selection Guide	495

■ HELUTEC® – THREE TECHNOLOGIES FOR EASY HANDLING



EMV
IP 66/67
20G-
Vibration-resistant

The innovative HELUTEC® system

This sensational, quick fastening connector is safe and stable while saving time and installation costs. The vibration resistant lock mechanism was perfected for plug connectors sizes M17, M23 and M40, which can be found in the HELUTEC® series 617, 917, 623, 723, 923 and 940. The HELUTEC® angle junction boxes can be easily combined at any time with the HELUTEC® system or with standard lock nuts. This also addresses the issue of downward compatibility. Slide it on and rotate for a tight fit. Patented perfection included.



EMV
IP 66/67
20G-
Vibration-resistant

The Patented Special Development for the HELUTEC® Series 615/915

Fits in tight locations. In areas with limited space, just wind the pre-tensioned lock nut before sliding the nut into the lock position. A small rotation with a little pull at the plug releases the lock nut preventing an unintended release of the vibration resistant quick fastener. Only a quarter turn and a slight pull on the connector is required to disconnect. The connection is absolutely vibration proof. This was specially developed and patented for the HELUTEC® series 615/915.



The freely customizable connector

Bonded for life. Once the connector housing and the shell are united in the assembly process they can not be separated anymore. This provides the required manipulation security for customized units - a design that is normally only available for cast versions. All commercially available cables at any length can be connected to the inner section of the robust metal housing. This is for both options: Standard screw connections or those items that include a patented fast lock system. For almost any pin design.

■ HELUTEC® – FUNCTIONAL DESIGN FOR HARSH ENVIRONMENTS



Frost protection down to -50 °C

A cool thing: HELUTEC®-connectors are temperature-resistant way down below freezing point. It is therefore predestined for special tasks in extreme climate zones, where they work without failure and fail-safe. The electric and mechanic values remain unimpressed. Even if it heats up: the connectors do not have a problem with 130°C, they stay cool. Also in smallest sizes available - they withstand harsh conditions and keep their unique design.



Protection classification IP 66/67 & 69K

Perfect for wetlands: Generally all HELUTEC® connectors are protected against water spray and temporary immersion. Every cable assembly with connector and cable strand is IP 66/67 protected. For special applications such as in water and/or steam, they can additionally qualified acc. to IP 69K. To fulfil the requirements of this highest protection classification and to guarantee unlimited safety, the cable clamp is fine tuned to the relevant cable. Even if standard screw connectors or HELUTEC® system – the robust metal housing with integrated EMC screening withstands extremely moistures.



Protection classification IP 68

Working under pressure: The special HELUTEC® series 615/915 are also capable of long-term missions under water. Even permanent immersion of about 120 hours at 15 meter under water with 1.5 bar pressure do not cause any problems, as tests have shown. Reward of these efforts: the qualification of both series acc. to protection classification IP68.

■ HELUTEC® – SERIES 617 / 623 / 627 SIGNAL CONNECTORS – CONTROLLING – MONITORING



Stable, versatile, safe: HELUTEC® series can be found where a safe connection is required within a limited installation space. The plug connectors in the 617, 623 and 627 series are designed especially for extra-low voltages, and are used in any application that transmits signals, controls motors or monitors the smooth functioning of a system.

For this purpose, a multitude of multi-pin insulation bodies - matching a variety of different designs such as plugs, couplings and flush-mounted boxes - are available for the user. Consequently, HELUTEC® engineers are able to handle a multitude of customer-specific connector requirements in a very innovative way.

Properties:

- Drive systems
- Robotics
- Mechanical engineering
- Automation mechatronics
- Medical technology
- Packaging and Printing
- Aerospace
- Equipment construction machinery
- Railway technology
- Shipbuilding
- Renewable energies
- Lightning, sound and stage equipment
- Food industry
- Textile industry

Technical data, please see selection table for signal and power / hybrid on page 519.
For detailed information and our online configurator, please see www.helukabel.de

■ HELUTEK® – SERIES 917 / 923 / 932 / 940 / 958 POWER PLUG CONNECTORS – STRONG AND SAFE



Extremely resilient: HELUTEK® power plug connectors accelerate torque heavy drive motors, spindle drives and servo motors reliably up to the highest rotational speeds while tolerating millions of abrupt starts and stops. Voltages up to 630 V and currents of up to 200 A are transferred reliably even in continuous operation and under the most demanding conditions. Cable cross sections of up to 50 mm² and the smallest possible designs are - depending on the application - part of the scope of delivery as well as a perfect EMC shielding for the highest operational and work safety.

Strong vibrations and sudden stops have no impact on these plug connectors in day-to-day operations, neither do heat, cold, moisture, dust and dirt.

All high performance connectors are tested in the test lab to safeguard the long-term durability in the field (up to 50 G). Besides special stress tests, individual customer requirements are analysed in terms of adjustments to the installation situation and integrated system solutions.

Properties:

- Drive systems
- Robotics
- Mechanical engineering
- Automation mechatronics
- Medical technology
- Packaging and Printing
- Aerospace
- Equipment construction machinery
- Railway technology
- Shipbuilding
- Renewable energies
- Lightning, sound and stage equipment
- Food industry
- Textile industry

Technical data, please see selection table for signal and power / hybrid on page 519.
For detailed information and our online configurator, please see www.helukabel.de

■ **HELUTEC® – SERIES 723**
HYBRID-CONNECTOR WITH BUS MODUL

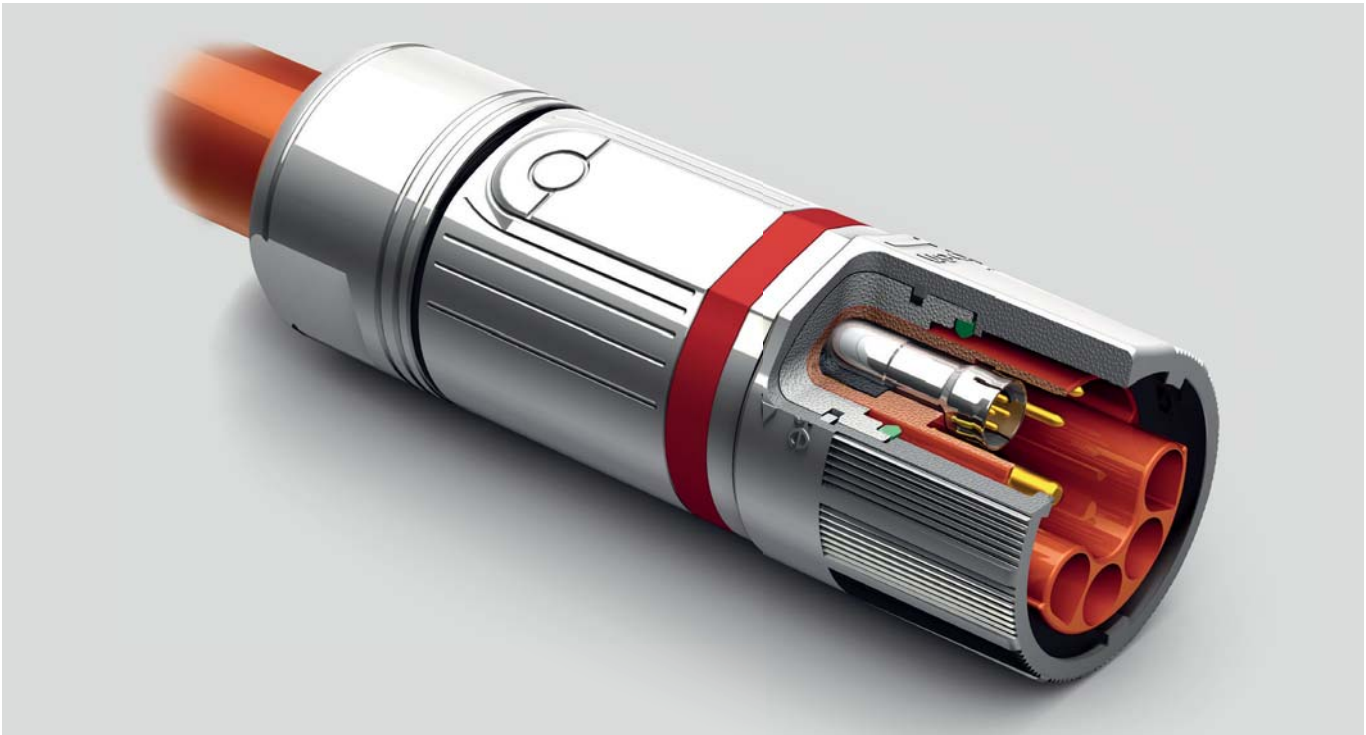

Full speed ahead - with six signal contacts plus one quadax element. The latter provides for fast Industrial Ethernet (CAT 5) connections in real time mode and opens completely new possibilities with its ready-to-assemble, separately shielded Ethernet element. When daisy-chaining decentrally controlled servo motors for example, it is possible to run 850 VDC. Therefore the super-hybrid connector size M23 can also handle 30 A of current and a wire cross section up to 4.0 mm².

The superior technical data speak for themselves as well as the many versions that are available: HELUTEC®-Serie 723 for all common flange and screw-in versions. No matter if it is a straight, angled or continuously rotating connector housing - this connector with patented HELUTEC® system is the new star on the horizon for application in automation technology.

Notes:

Lightning fast data transfer with a numerous field bus systems.



CANopen

DeviceNet

Ether**CAT**
Technology Group



PROFI
BUS

Technical data, please see selection table for signal and power / hybrid on page 519.
For detailed information and our online configurator, please see www.helutec.de

■ HELUTEK® – SERIES 615 / 915 THE ULTRA-FLAT DEVICE CONNECTOR

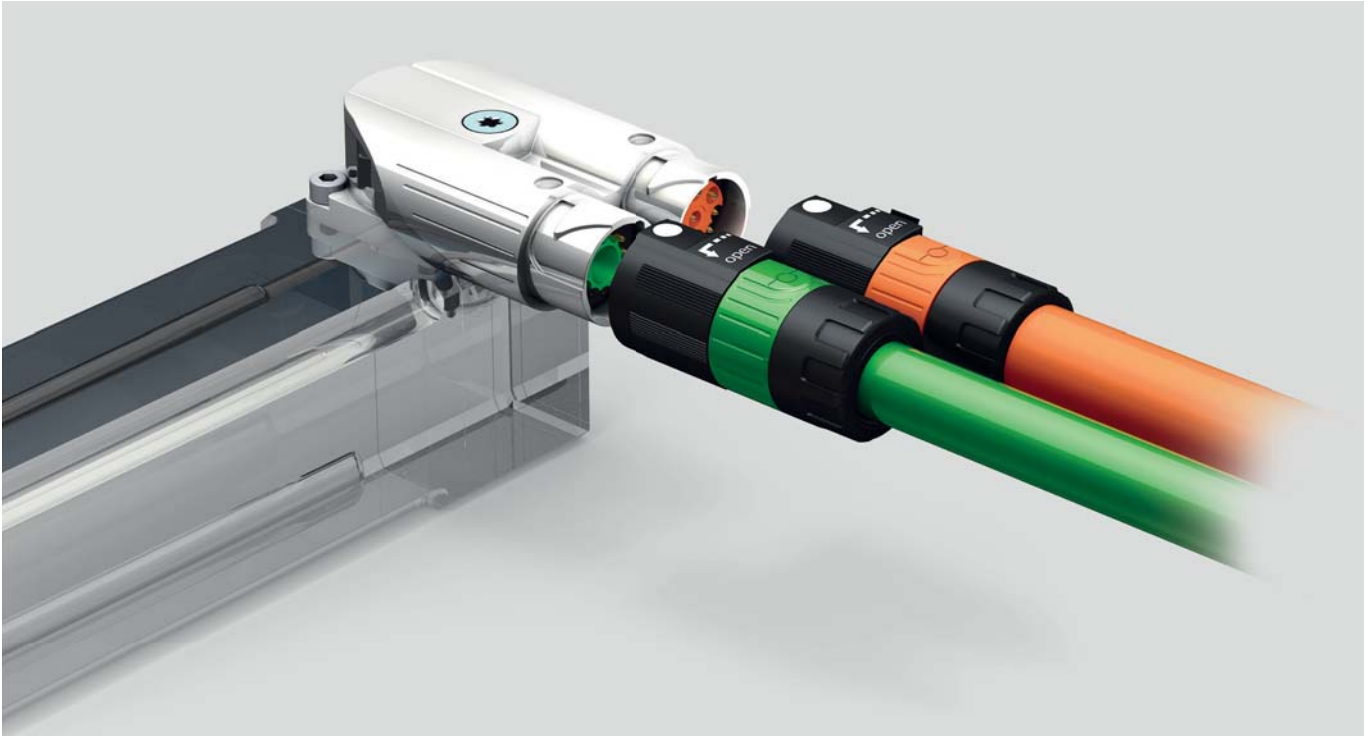

Small in size yet great in performance: The system impresses with high performance in small format.

Only one mounting hole is required to realize a combination of power and signal connection or power and bus connection on a small motor. The optimal partition of connector lid and connector housing and the therefore available large assembly space makes it easier than ever: Mechanical as well as colour codings provide additional safety. Except for crimping the system requires no special tools. In addition, the system remains 300° continuously rotatable after installation.

The single version offers the same characteristics as its big brother and is available as signal or power connector. Thus it is perfectly suitable for miniaturized applications, where space is critical and room for cabling limited. There is no easier way to establish save connections today.

Properties:

- **EMC**
- **IP 66/67**
- **20G-**
Vibration-resistant
- **UL** [®] **US**

Technical data, please see selection table for signal and power / hybrid on page 519.
For detailed information and our online configurator, please see www.helukabel.de

■ HELUTEC® – SERIES 926

A PLASTIC CONNECTOR FOR STAGE AND LIGHTNING

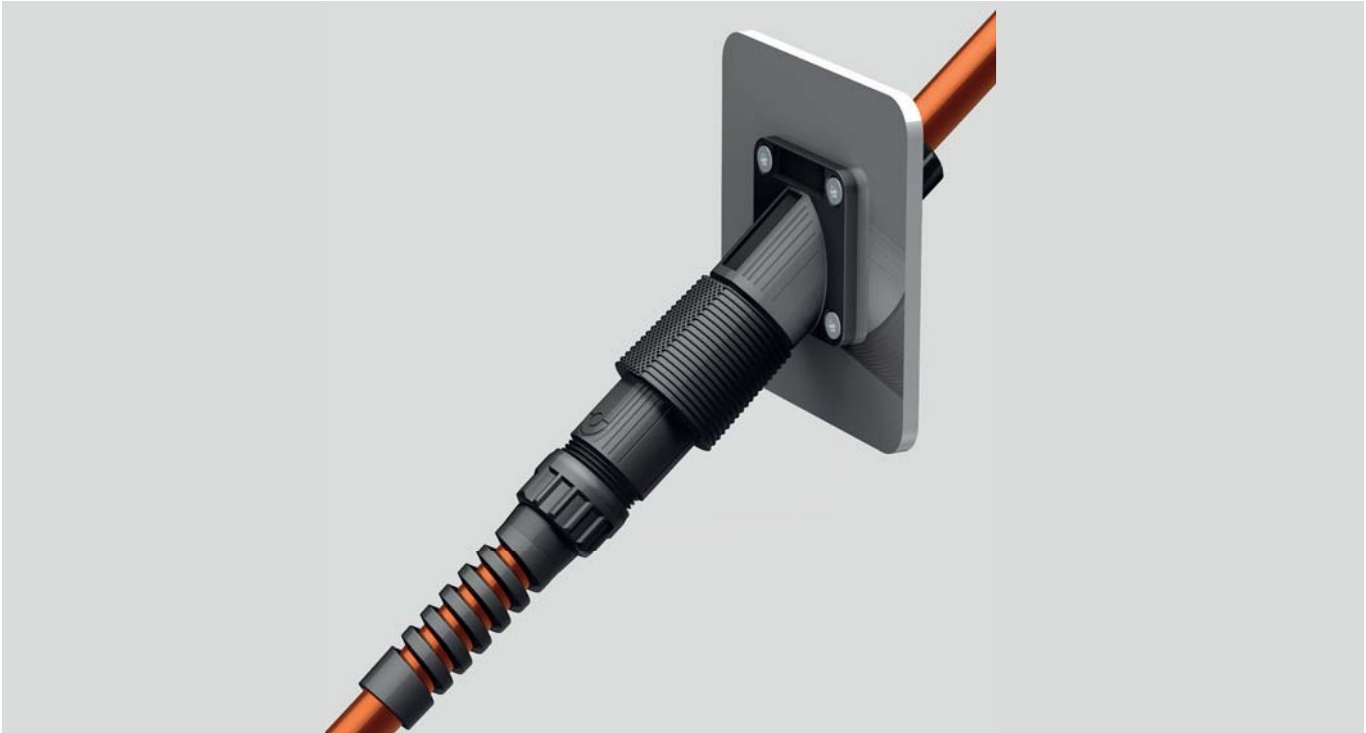

Curtains up - for the series 926 and for everybody who stands in the limelight treading the boards. These connectors are a shining example for an innovative, reliable and easy to use plastic connector.

Safety is a top-priority: Lightning and stage technicians must be protected from electric shock when handling cables and equipment.

The solid plastic design, flame retardant according to UL 94 VO and the modern connection method with a 'one hand push-pull mechanism' point the way into the future. Connectors are also clearly coded facilitating fast and intuitive handling.

Thanks to its high protection classification of IP66/67 and with outstanding 630 V rated voltage and 66 A rated current while ready to take on 16 mm² wires - the series 926 is well established for the use in other fields. Offshore and marine applications from oil rigs and wind turbines to any kind of seafaring vessel are only examples for the capabilities of this system. Thus, nobody is standing in the dark on the high seas.

Properties:

- **IP 66/67**

■ TOOLS AND ACCESSORIES

Crimping pliers



CRIMPING PLIERS FOR SERIES A, B AND F

Manual crimping pliers

for Ø 1 mm contacts
to core cross-section 1 mm²
including positioning insert
Order no.: C0.101.00



CRIMPING PLIERS FOR SERIES A, B, C, D AND F

Manual crimping pliers

for Ø 1 mm contacts and
Ø 2 mm
contacts to core cross-section 4 mm²
inclusive positioning basic body
Order no.: C0.201.00



Positioning insert
for Ø 1 mm contacts
Order no.: C0.003.00



Positioning insert
for Ø 2 mm contacts
Order no.: C0.004.00



Positioning insert
for Ø 1 mm contacts and
Ø 2 mm contacts
Order no.: C0.009.00

■ TOOLS AND ACCESSORIES

Crimping pliers



CRIMPING PLIERS FOR SERIES M17

Manual crimping pliers

for \varnothing 0.6 mm contacts
to core cross-section 0.5 mm²
including positioning insert

Order no.: C0.231.00



CRIMPING PLIERS FOR SERIES C

Manual crimping pliers

for \varnothing 3.6 mm contacts
to core cross-section 16 mm²
inclusive positioning basic body

Order no.: C0.008.00



Positioning insert

for \varnothing 3.6 mm contacts

Order no.: C0.010.00

TOOLS AND ACCESSORIES

Crimping pliers



PNEUMATIC CRIMPING PLIERS

for Ø 3.6 mm contacts and
 Ø 2.0 mm contacts
 Core cross-section 1.5 - 16 mm²
 Order no.: C0.044.00



Crimping inserts
 for crimping pliers C0.044.00



Locator
 for crimping pliers C0.044.00

Order no.:	Contact:	Crimping range
C0.042.00	male Ø 2.0 mm	1.5 / 2.5 mm ²
C0.041.00	female Ø 3,6 mm	1.5 / 2.5 mm ²
C0.040.00	male/female Ø 3.6 mm	4.0 / 6.0 mm ²
C0.043.00	male/female Ø 3.6 mm	10.0 mm ²
C0.233.00	male/female Ø 3.6 mm	16.0 mm ²

Order no.:	Contact:	Crimping range
C0.036.00	male/female Ø 2.0 mm	1.5 / 2.5 mm ²
C0.037.00	male/female Ø 3.6 mm	1.5 - 10.0 mm ²
C0.038.00	male/female Ø 3.6 mm	1.5 - 16.0 mm ²



BATTERY POWERED CRIMPING PLIERS FOR SERIES S AND D

B131-C
 Order no.: C0.207.00



Crimping inserts
 to 10 mm², 16 mm²
 Order no.: C0.211.00



Crimping inserts
 to 35 mm²
 Order no.: C0.209.00



Crimping inserts
 to 25 mm²
 Order no.: C0.210.00



Crimping inserts
 to 50 mm²
 Order no.: C0.208.00

■ TOOLS AND ACCESSORIES

Crimping pliers



MANUAL CRIMPING PLIERS FOR REEL FEED CONTACTS SERIES A AND F

Manual crimping pliers for reel feed contacts Ø 1 mm

Crimping range: 0.03 - 1.0 mm²

Order no.: C0.237.00



1 mm Reel feed male

Order no.:	Crimping range
61.170.80.025	0.03 - 0.08 mm ²
61.171.80.025	0.08 - 0.20 mm ²
61.172.80.025	0.20 - 0.52 mm ²
61.173.80.025	0.75 - 1.00 mm ²

VPE: 10 stripes à 25 pcs. male reel feed contacts



1 mm female reel feed contacts

Order no.:	Crimping range
60.198.80.021	0.03 - 0.08 mm ²
60.199.80.021	0.08 - 0.20 mm ²
60.200.80.021	0.20 - 0.52 mm ²
60.201.80.021	0.75 - 1.00 mm ²

VPE: 10 stripes à 25 pcs. reel feed contacts



CRIMPING PLIERS FOR REEL FEED CONTACTS SERIES B AND C

Manual crimping pliers for reel feed contacts Ø 2 mm

Crimping range: 1.5 - 2.5 mm²

Order no.: C0.073.00

Manual crimping pliers for reel feed contacts Ø 2 mm

Crimping range: 0.5 - 1.0 mm²

Order no.: C0.072.00

Unit not included



Reel feed female Ø 2 mm
Crimping range: 0.5 - 2.5 mm²
Order no.: 60.046.21.015

Packaging unit:
200 pcs. reel feed female contacts per unit

■ TOOLS AND ACCESSORIES

Stripping and crimping machine



STRIPPING AND CRIMPING MACHINE STRIPCRIMP 750 FOR SERIES A, B, C AND F

B131-C

Order no.: WA10043

Order no.:	Description	Crimping range	Crimping size	Tool no.
1 mm contacts				
60.198.80	Reel feed female	0.03 - 0.08 mm ²	1	WM10241
60.199.80	Reel feed female	0.08 - 0.20 mm ²	2	WM10242
60.200.80	Reel feed female	0.20 - 0.52 mm ²	3	WM10243
60.201.80	Reel feed female	0.75 - 1.00 mm ²	4	WM10244
2 mm contacts				
61.170.80	Reel feed male contact	0.03 - 0.08 mm ²	1	WM10241
61.171.80	Reel feed male contact	0.08 - 0.20 mm ²	2	WM10242
61.172.80	Reel feed male contact	0.20 - 0.52 mm ²	3	WM10243
61.173.80	Reel feed male contact	0.75 - 1.00 mm ²	4	WM10244
Packaging unit: 7,000 pcs. reel feed contact per unit				
2 mm contacts				
60.046.21	Reel feed female	0.50 - 2.50 mm ²		WM10246
Packaging unit: 3,000 pcs. reel feed contact per unit				

Stichworte

Stichwort	Seite
schiffskabel)	W 7
schiffskabel)	W 7
us FF Typ A	R 123 - R 125
ieb	D 17 - D 24
tur	U 63
	N 15
	N 113 - N 114
	Q 31

TABEL & LEITUNGEN

Stromprüfung FT 4	Brandprüfung FT 1 (mit FT 2)	Nennspannung nach UL	Nennspannung nach VDE	halogenfrei	alter-tauglich **	weichtauglich UV
x		1000 V	0,6/1kV	x	x	x
x		1000 V	0,6/1kV	x	x	x

	PE	PUR	H	Silicon	Nexpre Gumm
IZ-602-RC-C-PUR					
Single 602-RC-1/O					
Single 602-RC-CY-1/O					
IZ-602 RC					
IZ-602 RC-PUR					
IZ-602 RC-CY					
IZ-602 RC-C-PUR					
IZ-HF					
IZ-HF-CY					
MULTIFLEX* 600					
MULTIFLEX* 600-C					
PUR0-IZ-HF					
PUR0-IZ-HF-YCP					
MULTIFLEX 512* PUR					
MULTIFLEX 512*-C-PUR					
MULTIFLEX 512*-PUR UL/CSA					
MULTIFLEX 512*-C-PUR UL/CSA					
IZ-HF-FCY					

Spezialkabel-Verzeichnis

Seite	Artikel-Nr.	Seite
	33240 - 33274	Q 1
		Q

AUSWAHLTABELLE - Leitungen für Energieführungsketten

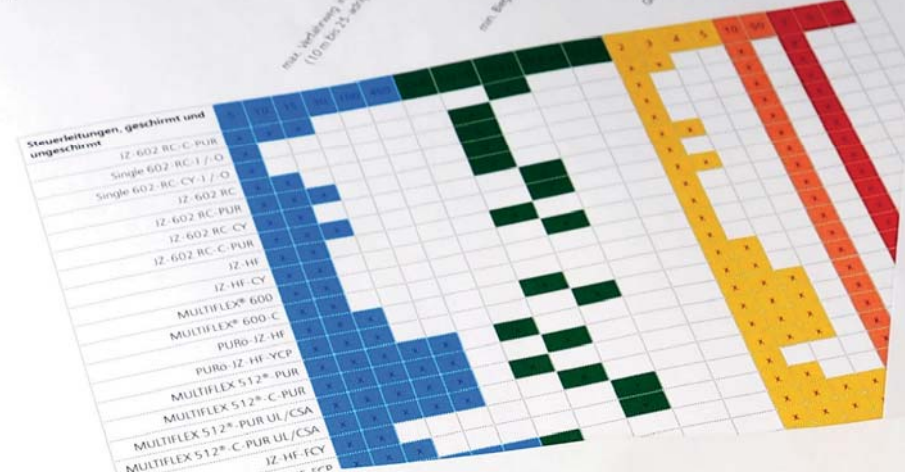

AUSWAHLTABELLE

Stromerweiterungen	Abmessung	Material
IZ-500	CE-V	
F-CY-IZ	CE-V	
Y-CY-IZ	CE-V	
IZ-500 HMH	CE-V	
IZ-500 HMH-C	CE-V	
MEGAFLEX 500	UL-CS	
MEGAFLEX 500-C	UL-CS	
IZ-500	UL-CS	
IZ-600 Y-CY	UL-CS	
Single 600-IZ/O	UL-CS	
Single 600-CY-IZ/O	UL-CS	
IZ-600 HMH	UL-CS	
IZ-600 HMH-C	UL-CS	



Erhebungsbogen für Energieführungsketten

Firma _____
 Vorname, Name _____
 Straße, Nr. _____
 PLZ, Ort _____
 Telefon / Fax _____
 E-Mail _____

Einsatzort _____
 Maschinenart _____
 In Betrieb seit _____
 Absender / Stempel _____

1. Energieführungsparameter

- Kettenlänge/Kettenbreite _____ m/mm
- Kettenteilung _____ mm
- Krümmungsradius _____ mm
- Trennsteg vorhanden ja nein
- Zwischensteg vorhanden ja nein
- Anordnung/Installation horizontal vertikal

2. Einsatz- und Bewegungsparameter

- Verfahrensweg (max.) _____ m
- Verfahrgeschwindigkeit _____
- Verfahrbesc _____
- Verfahrhäufi _____
- Mittl. Verfahr _____
- Tägliche Einsa _____
- Einspeisung in _____
- Zusatzgewicht _____

3. Leitungsp:

- Leitungslänge (ge) _____
- Leitungslänge (bev) _____
- Anzahl der Leitunge _____
- Leitung zugentlastet _____
- Anzahl der Adern pro _____
- Leitung geschirmt _____
- Leitung halogenfrei _____

Anfrage Spezialkabel

Tel. 07150 9209 0
 Fax: 07150 81786
 E-Mail: anfrage-spezialkabel@helukabel.de

Anfrage

Jahresbedarf ca. _____ m
 gew. Liefertermin _____
 Abmessung _____

- a) innen außen
 b) feste Verlegung beweglicher Einsatz
 c) Schleppkette: Verfahr-geschw. _____ m
 Beanspruchung _____
 Umgebung _____ °C

■ TECHNICAL INFORMATION

Description	Page
Basic functions of a cable gland	502
Installation notes - Cable glands	503
Approvals HELUTOP HT	504
Clamping ranges HELUTOP HT	505
Cable glands for increased operating temperature	506
IP-Code Protection classification acc. to EN 60529	507
Description of fire protection acc. to UL 94	508
Size comparison and metric/PG/NPT/BSP installation dimensions	509
Size comparison AWG/mm	510
Selection guide Anaconda Sealtite/Conduit gland	511
Selection guide - Flexible protection tube / Conduit gland253	514
Selection guide - Wires for energy drag chains	518
Selection table	520
Assembly instructions - Cable lugs	521
Compression instruction	522
Keyword index	525
Item number index	531
Notes	549

■ BASIC FUNCTIONS OF A CABLE GLAND

Cables and wires transfer	<ul style="list-style-type: none">• Energy (current)• Signals and data (current, voltage, light)
Cable protection	If a wire has to be connected in a housing, the housing must have a protective lead-through. Otherwise, there is the risk that the wire could be damaged in case of movement.
Strain relief	A wire is moving more or less - during installation or in long-term use. Important is the tensile load protection. The movements may be either constant or intermittent. Therefore, a cable gland with strain relief is necessary. Strain reliefs are described in EN 50262. A differentiation is made between retention, strain relief A and strain relief B. Generally, cable glands have strain relief A.
Protection classification	The lead-through in the wall of the housing must be sealed. This is described by the protection classification IP. The cable glands presented here have protection classification IP68, 5 bar. The 6 stands for "no dust penetration", the 8 stands for "protected when permanently submerged in water" - this is tested at a water pressure of 5 bar (corresponds to 50 m depth) for a duration of 30 min.
Seal with insert	A seal is compressed by tightening the cap nut. A particularly high quality seal and strain relief are achieved.
Seal with clamping plates	When the cap nuts are screwed tight, lamellae press against the moulded seal - the wire is thereby sealed and the strain is relieved. The particular advantage of the clamping plate is that they make a large clamping range possible, to allow for different wire diameters.
Resistance	Different applications demand different degrees of resistance. Plastic cable glands made of Polyamide 6 can be used at a temperature range from -20°C to +100°C, they are abrasion and impact resistant, and withstands hydrocarbons/fuels and cleaning agents. Stainless steel cable glands are suitable for heavy-duty use - they are watertight and resistant to a large number of disinfectants used in food production. Brass glands are used when a long-lasting metal gland is required. Cable glands for electromagnetic compatibility (EMC) are made of brass.
Compact design	<ul style="list-style-type: none">• No disassembly during final assembly. Simply loosening the cap nuts.• No losing components• Quick assembly
Standard EN 50262	Cable glands are produced and tested according to the standard EN 50262. This stipulates the dimensions of the connection threads ('metric connection thread') as well as a series of safety-relevant parameters, e.g. strain relief. Cable glands are also available with another threaded connection (PG, NPT etc.).
RoHS	Due to the directive 2002/95/EG environmental-relevant standards for electrical and electronic components and devices are generated. This is known as RoHS for short: Restriction of the use of certain hazardous substances in electrical and electronic equipment The use of heavy metals (lead, cadmium, etc.) and a number of other hazardous substances is forbidden.

■ INSTALLATION NOTES - CABLE GLANDS

Disassembly of the glands	HELUTOP® HT, HSK, Helufast, UNI-DICHT, KVA, SD is not necessary – provided that the cap nut is applied in such a way as to allow smooth running, there is no problem with subsequent insertion of the cable.
Screwing in	When screwing, observe the necessary tightening torque. If only one through-hole without thread is available, a lock nut must be used; exception are the threadless cable glands.
Protection classification	In order to achieve the desired protection classification even when working with an unfavourable surface, it may be necessary to use an O-ring or a connection thread gasket. To ensure a consistently high-quality seal, we recommend re-tightening the gland some time after assembly.
Lead through cable - turn cap nut - that's all there is to it!	

■ APPROVALS HELUTOP® HT

HELUTOP® HT-M Polyamid Cable Gland, Metric Thread

Approval certificate no. 138040

Approval certificate no. 134171

Type designation BM (correspond to HELUTOP® HT-M)

For all products:

Temperature range: -20°C / +80°

Protection classification: IP 68 - 5 bar (30 min.)

Size	Sealing range	Clamping area of strain relief	Category of strain relief	Installation torque certified acc.to EN 50262*	Category of impact effect
metric	mm	mm		Nm	
M12x1,5	3-6	3-6	A	1,7/2,5	2
M16x1,5	4-8	4-8	A	2,5/3,75	2
M16x1,5	5-10	5-10	A	2,5/3,75	2
M20x1,5	6-12	6-12	A	3,3/3,75	2
M20x1,5	10-14	10-14	A	3,3/3,75	2
M25x1,5	12-17	12-17	A	5,0/7,5	2
M25x1,5	13-18	13-18	A	5,0/7,5	2
M32x1,5	15-21	15-21	A	12/7,5	4
M32x1,5	18-25	18-25	A	12/7,5	4
M40x1,5	19-28	19-28	A	12/7,5	4
M40x1,5	22-31	22-31	A	12/7,5	4
M50x1,5	30-36	30-36	A	12/7,5	4
M63x1,5	34-44	34-44	A	12/7,5	4
M63x1,5	35-44	35-44	A	12/7,5	4

*Cap nut/Gland body or lock nut

			VDE	UR/UL	CSA(US)	
Helutop HT	metric	M12 - M16		-		
		M20	VDE	UL		
		M32 - M63		-	CSA(US)	
	PG		-	-		
	NPT	1/4" - 1"	-	-		
Helutop HT-R	metric, reduced	M12 - M63	-	-	CSA(US)	
Helutop HT-BS	metric	M12 - M16		-		
		M20	VDE	UL	CSA(US)	
		M32 - M63		-		
Helutop HT-K	metric	M12 - M63	-	-		
	PG		-	-	CSA(US)	
	NPT	1/4" - 1"	-	-		
Helutop-HT-MS	metric	M12 - M16		UR		
		M20 - M63		UL		
	PG		-	-		
	NPT	1/4" - 3/8"		-	UR	
		1/2"		-	UL	
		3/4" - 1"		-		
Helutop MS-EP	metric	M12 - M16		UR	-	
		M20 - M63		UL		
	NPT	1/4" - 3/8"		-	UR	
		1/2"		-	UL	
		3/4" - 1"		-		
Helutop MS-E	PG		-	-	-	
Helutop HT-E	metric	M12 - M16		UR		
		M20 - M63		UL		
	PG		-	-		
	NPT	1/4" - 3/8"		-	UR	
		1/2"		-	UL	
		3/4" - 1"		-		
Status: 15. October 2007						

■ CLAMPING AREAS HELUTOP® HT

Clamping areas	Gland type		
	HELUTOP® HT	HELUTOP® HT-R	HELUTOP® HT-K
Polyamide	HELUTOP® HT	HELUTOP® HT-R	HELUTOP® HT-K
Polyamid, with pre-assembled blind plate	HELUTOP® HT-BS		
Stainless steel	HELUTOP® HT-E		
Stainless steel	HELUTOP® HT-MS	HELUTOP® HT-MS-R	
Brass, for EMC applications	HELUTOP® HT-MS-EP		
Thread size	Standard	Reduced sealing insert	with kink protection
M 12x1,5	3,0 - 6,5 mm	2,0 - 5,0 mm	3,0 - 6,5 mm
M 16x1,5	4,0 - 8,0 mm	3,0 - 7,0 mm	
M 16x1,5	5,0 - 10,0 mm		5,0 - 10,0 mm
M 20x1,5	6,0 - 12,0 mm	5,0 - 9,0 mm	6,0 - 12,0 mm
M 25x1,5	11,0 - 17,0 mm	9,0 - 13,0 mm	10,0 - 14,0 mm
M 32x1,5	15,0 - 21,0 mm	11,0 - 15,0 mm	13,0 - 18,0 mm
M 40x1,5	19,0 - 28,0 mm	14,5 - 23,0 mm	
M 50x1,5	28,0 - 38,0 mm	24,0 - 31,0 mm	
M 63x1,5	34,0 - 44,0 mm	29,0 - 35,0 mm	

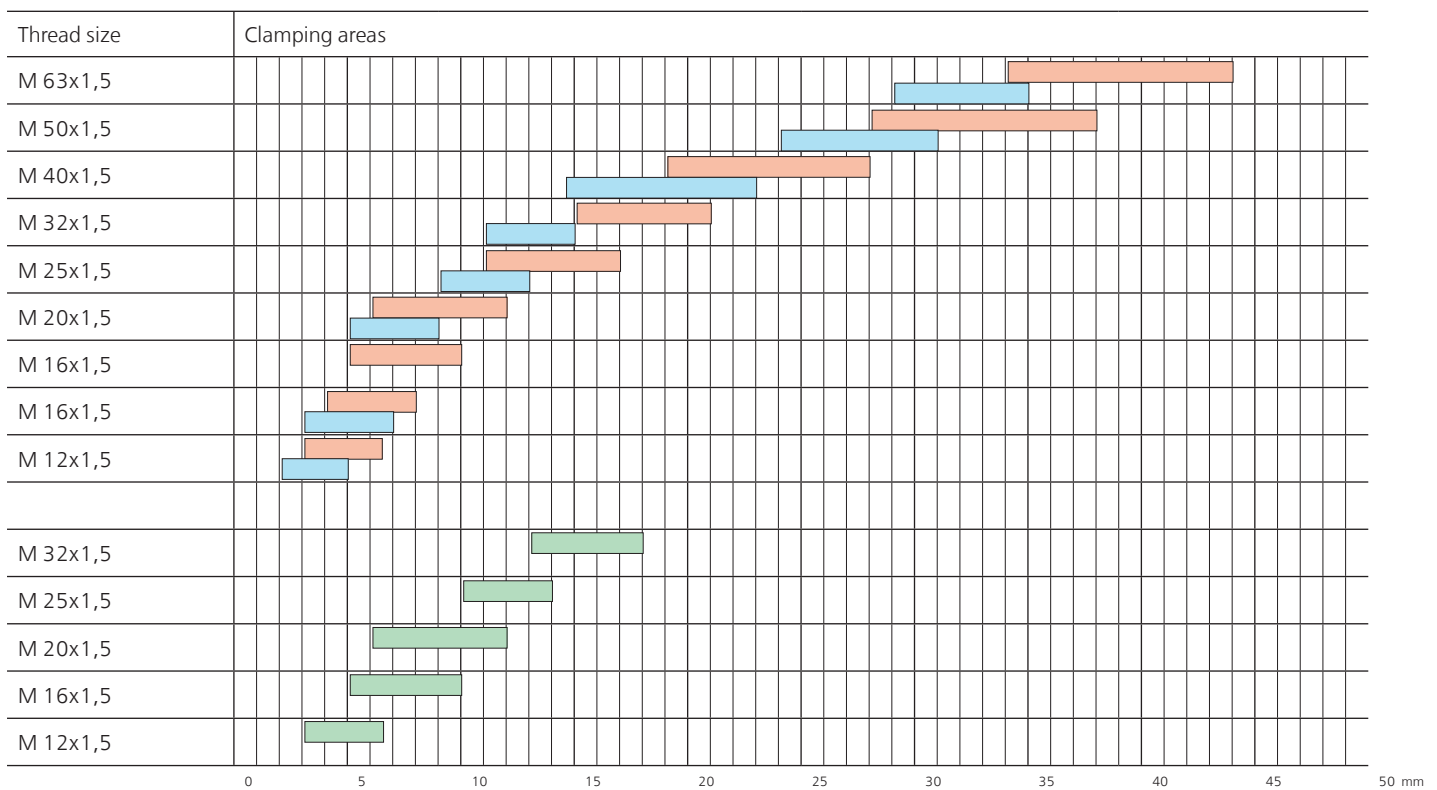

CABLE GLANDS FOR INCREASED OPERATING TEMPERATURES

Description	Material	Temperature	Page	
Cable glands				
Series HELUTOP® HT	HELUTOP® HT-MS Plus	Stainless steel	120 °C	177
Series HELUTOP® HT	HELUTOP® HT-MS C Plus	Stainless steel	120 °C	178
Series HSK	HSK-PVDF	PVDF (Polyvinylidenfluorid)	150 °C	141
Series HSK	HSK-MS-PVDF	Seal with PVDF insert	150 °C	143
Series UNI-DICHT	UNI-DICHT-ASI-MS	Brass, for ASI BUS cables	135 °C	87
Series UNI-DICHT	UNI-DICHT-VK-MS	Brass, for ASI BUS cables	200 °C	85
Series UNI-DICHT	UNI-DICHT-VK-PVDF	Brass, for ASI BUS cables	150 °C	146
Series UNI-DICHT	UNI-DICHT-VK stainless steel	Stainless steel gland body	200 °C	147
Series UNI-DICHT	UNI-DICHT sealing insert closed	Sealing insert	135 °C	49
Series UNI-DICHT	UNI-DICHT MFDE multiple sealing insert	Sealing insert	130 °C	52
Series UNI-DICHT	Lock bolts (PVDF / black)	Sealing insert	150 °C	33
Series UNI-DICHT	UNI-DICHT sealing insert silicone	Sealing insert	200 °C	148
Series UNI-DICHT	UNI-DICHT sealing insert for ASI-Bus cable	Sealing insert	135 °C	55
Series KVA	KVA-ASI-MS	Brass, for ASI BUS cables	135 °C	97
Series KVA	KVA-VK-MS	Brass gland body	200 °C	92
Series KVA-XXL	KVA-XXL-MS cable gland	Brass, for very large cable diameter	135 °C	99
Series KVA-XXL	KVA-XXL-KV-MS gland body	Brass, for very large cable diameter	200 °C	100
Series SD	SD	Stainless steel	120 °C	102
Cable glands (EMV)				
Series KVA-XXL	KVA-XXL-MS-E		135 °C	134
Lock nut	KM-EMV		200 °C	135

Description	Function	Temperature	Page	
Accessories / Parts				
Strain reliefs	ZE		200 °C	108
Strain reliefs	ZEI		200 °C	110
Thread adapter	Adapter hexagon	Adapter	200 °C	111
Thread adapter	Adapters round	Adapter	200 °C	113
Thread adapter	EW round	Extension	200 °C	115
Thread adapter	RE hexagon	Reducer	200 °C	116
Thread adapter	RE round	Reducer	200 °C	118
Lock nut	KM		200 °C	119
Lock nut	KM-INOX		200 °C	149
Screw plug	VS-O stainless steel		200 °C	150
Gasket	Incision sealing ring		120 °C	71
Reinforced wall sealing	O-ring		120 °C	67
Reinforced wall sealing	O-ring FPM		200 °C	151

■ IP-PROTECTION CLASSIFICATION

Definition of IP-Code Protection classification acc. to EN 60529

The IEC 60529 „Protection classifications using enclosure (IP-Code)“ provides a system for classifying the protection ratings of electrical operating materials by enclosure. This standard defines terms for the protection classifications by enclosure concerning:

- Protection of persons against access to dangerous parts inside the enclosure
- Protection of operating material inside the enclosure against ingress by solid foreign substances
- Protection of operating material inside the enclosure against damage by the ingress of water

Protection level against solid foreign bodies			Protection level against water		
First number	Short description	Definition	Second number	Short description	Definition
0	Not protected	The object sensor, a 50 mm ball, must not fully penetrate.	0	Not protected	Vertically falling droplets must not have a damaging effect.
1	Protected against solid foreign bodies of 50 mm diameter and larger	The object sensor, a 12.5 mm ball, must not fully penetrate.	1	Protected against dripping water	Vertically falling droplets must not have a damaging effect if the enclosure is tilted by an angle of up to 15° on both sides of the perpendiculars.
2	Protected against solid foreign bodies of 12.5 mm diameter and larger	The object sensor, a 2.5 mm ball, must not penetrate at all.	2	Protected against dripping water if the enclosure is tilted by up to 15°.	Water sprayed at both sides of the perpendiculars at an angle of up to 60° must not have a damaging effect.
3	Protected against solid foreign bodies of 2.5 mm diameter and larger	The object sensor, a 2.5 mm ball, must not penetrate at all.	3	Protected against spray water	Water sprayed at both sides of the perpendiculars at an angle of up to 60° must not have a damaging effect.
4	Protected against solid foreign bodies of 1.0 mm diameter and larger	The object sensor, a 1.0 mm ball, must not penetrate at all.	4	Protected against spray water	Water sprayed against the enclosure from one direction must not have a damaging effect.
			4K	Protected against spray water with high pressure high pressure	Water sprayed against the enclosure from any direction at increased pressure must not have any damaging effects. (Only applies to road vehicles according to DIN 40 050 Part 9)
5	Dust protection	Dust penetration is not prevented completely. The amount of penetration, however, must not impair the function or safety of the device.	5	Protected against	Water sprayed against the housing in a strong jet from every direction must not have a damaging effect.
6	Dust protection	No dust penetration	6	Protected against strong hose water	Water sprayed against the housing in a strong jet from every direction must not have a damaging effect.
			6K	Protected against strong hose water with high pressure	Water sprayed against the housing with high pressure from one direction must not have a damaging effect. (Only applies to road vehicles according to DIN 40050 Part 9)
			7	Protected against the effect when temporarily submerged under water	The volume of penetrating water must not have a damaging effect when the housing is temporarily submerged under water at a certain pressure.
			8	Protected against the effect when permanently submerged under water	The volume of penetrating water must not have a damaging effect when the housing is permanently submerged under water at a certain pressure.
			9K	Protected against the effect of water from high-pressure cleaners.	Water sprayed against the housing under increased pressure from one direction must not have a damaging effect. (Only applies to road vehicles according to DIN 40050 Part 9)
For example: Letters IP 65			First index: Protection against contact and ingress by foreign bodies Second index: Protection against liquid		

■ DESCRIPTION OF FIRE PROTECTION ACC. TO UL 94

Fire protection HB

In the horizontal combustion test, the material combusts slowly. Therefore, the combustion speed must not exceed 3 inch/min to 3 mm wall thickness and 1,5 inch 7 min at over 3 mm wall thickness. Materials exceeding this combustion speed are not UL listed.

Fire protection V2

In the vertical combustion test, the material must self-extinguish after an average of 25 seconds (no single values over 30 seconds). Material drips can ignite wool placed underneath it. The afterglow, however, must not exceed 60 seconds.

Fire protection V1

In the vertical combustion test, the material must self-extinguish after an average of 25 seconds (no single values over 30 seconds). By contrast, any drips must not ignite the wool. The afterglow must not exceed 30 seconds.

Fire protection V0

In the vertical combustion test, the material must self-extinguish after an average of less than 5 seconds (no single values over 10 seconds). Eventually, any drips must not ignite wool and the afterglow must not exceed 30 seconds.

■ SIZE COMPARISON AND METRIC/PG/NPT/BSP INSTALLATION DIMENSIONS

x Metric long thread acc. to EN 60423

Nominal size	Outer diameter	Through-hole
M12x1,5	12,0	12,5
M16x1,5	16,0	16,5
M20x1,5	20,0	20,5
M25x1,5	25,0	25,5
M32x1,5	32,0	32,5
M40x1,5	40,0	40,5
M50x1,5	50,0	50,5
M63x1,5	63,0	63,5

PG – Long thread acc. to DIN 40430

Nominal size	Outer diameter	Through-hole
PG7	12,5	12,7
PG9	15,2	15,4
PG11	18,6	18,8
PG13,5	20,4	20,6
PG16	22,5	22,7
PG21	28,3	28,5
PG29	37,0	37,2
PG36	47,0	47,2
PG42	54,0	54,2
PG48	59,3	59,5

American tube thread NPT (conical)

Nominal size	Outer diameter	Through-hole
1/4"	13,616	
3/8"	17,055	
1/2"	21,223	
3/4"	26,568	
1"	33,227	
1 1/4"	41,984	
1 1/2"	48,053	
2"	60,091	
2 1/2"	72,699	
3"	88,608	
3 1/2"	100,013	

Gas tube thread BSP (British Standard Pipe)

Nominal size	Outer diameter	Through-hole
1/4"	13,157	13,4
3/8"	16,662	17,0
1/2"	20,955	21,3
5/8"	26,441	26,8
1"	33,249	33,7
1 1/4"	41,910	42,2
1 1/2"	47,803	48,3
2"	59,614	60,2
2 1/2"	75,184	75,5
3"	87,884	88,5
3 1/2"	100,330	101,0
4"	113,030	114,0

■ SIZE COMPARISON AWG/MM

AWG No.	Cross-section	Diameter mm
500	253	17,96
350	177	15,03
250	127	12,07
4/0	107,2	11,68
3/0	85,0	10,40
2/0	67,5	9,27
1/0	53,5	8,25
1	42,4	7,35
2	33,6	6,54
4	21,2	5,19
6	13,3	4,12
8	8,37	3,26
10	5,26	2,59
12	3,31	2,05
14	2,08	1,63
16	1,31	1,29
18	0,823	1,024
20	0,519	0,813
22	0,324	0,643
24	0,205	0,511
26	2,128	0,405
28	0,0804	0,320
30	0,0507	0,255
32	0,0324	0,203
34	0,0200	0,160
36	0,0127	0,127
40	0,00487	0,079
42	0,00317	0,064
44	0,00203	0,051

Conversion inch/mm	
Inch	mm
1/8	3,2
1/4	6,4
3/8	9,5
1/2	12,7
3/4	19,0
1	25,4
1 1/4	31,8
1 1/2	38,0
2	50,8
2 1/2	64,0
3	76,0
4	101,6

SELECTION GUIDE ANACONDA SEALTITE/CONDUIT GLAND

ANACONDA SEALTITE

TUBE CONNECTOR

LT straight

EF	Small-VPE		OR	HTDL	HC	HCX	ZHLS	HFX	Shieldtite EMP	Tube NW	Size Metric	Size		Size		suitable Inner protec- tion sleeve	
	grau	schwarz										grau	schwarz	PG	NPT		
91229	96939										1/4						
91230	96248	94915	94930				94988	94994			5/16						
91231	96249	94916	94931	91245	98149	91238	94735	94989	94995	98156	3/8	M16 x 1,5	94151	11	91006	1/2" 905749	96839
														13,5	91007		
91232	97153	94917	94932	91246	98150	91239	96410	94990	94996	98157	1/2	M20 x 1,5	94152	16	91008	1/2" 905750	97480
91233	96718	94918	94933	91247	98151	91240	96954	94991	94997	98158	3/4	M25 x 1,5	94153	21	91009	3/4" 905751	96580
91234	96250			91248	98152	91241	97945	94992	94998	98159	1	M32 x 1,5	94154	29	91010	1" 905752	96803
91235	96251			91249	98153	91242	96247	94993	94999	98160	1 1/4	M40 x 1,5	94155	36	91011	1 1/4" 905753	96880
91236	97175			91250	98154	91243	97668			98161	1 1/2	M50 x 1,5	94156	42	91012	1 1/2" 905754	98364
91237	96252			91251	98155	91244	97811				2	M63 x 1,5	920522	48	91013	2" 905755	905027
											2 1/2						905028
											3						905029
											4						905030

LT elbow 45°

EF	Small-VPE		OR	HTDL	HC	HCX	ZHLS	HFX	Shieldtite EMP	Tube NW	Size Metric	Size		Size		suitable Inner protec- tion sleeve	
	grey	black										grey	black	PG	NPT		
91229	96939										1/4						
91230	96248	94915	94930				94988	94994			5/16						
91231	96249	94916	94931	91245	98149	91238	94735	94989	94995	98156	3/8	M16 x 1,5	94160	11	91014	1/2" 905756	96839
														13,5	91015		
91232	97153	94917	94932	91246	98150	91239	96410	94990	94996	98157	1/2	M20 x 1,5	94161	16	91016	1/2" 905757	97480
91233	96718	94918	94933	91247	98151	91240	96954	94991	94997	98158	3/4	M25 x 1,5	94162	21	91017	3/4" 905758	96580
91234	96250			91248	98152	91241	97945	94992	94998	98159	1	M32 x 1,5	94163	29	91018	1" 905759	96803
91235	96251			91249	98153	91242	96247	94993	94999	98160	1 1/4	M40 x 1,5	920526	36	91019	1 1/4" 905760	96880
91236	97175			91250	98154	91243	97668			98161	1 1/2	M50 x 1,5	920527	42	91020	1 1/2" 905761	98364
91237	96252			91251	98155	91244	97811				2	M63 x 1,5	920528	48	91021	2" 905762	905027
											2 1/2						905028
											3						905029
											4						905030

LT elbow 90°

EF	Small-VPE		OR	HTDL	HC	HCX	ZHLS	HFX	Shieldtite EMP	Tube NW	Size Metric	Size		Size		suitable Inner protec- tion sleeve	
	grey	black										grey	black	PG	NPT		
91229	96939										1/4						
91230	96248	94915	94930				94988	94994			5/16						
91231	96249	94916	94931	91245	98149	91238	94735	94989	94995	98156	3/8	M16 x 1,5	94170	11	91022	1/2" 905763	96839
														13,5	91023		
91232	97153	94917	94932	91246	98150	91239	96410	94990	94996	98157	1/2	M20 x 1,5	94171	16	91024	1/2" 905764	97480
91233	96718	94918	94933	91247	98151	91240	96954	94991	94997	98158	3/4	M25 x 1,5	94172	21	91025	3/4" 905765	96580
91234	96250			91248	98152	91241	97945	94992	94998	98159	1	M32 x 1,5	94173	29	91026	1" 905766	96803
91235	96251			91249	98153	91242	96247	94993	94999	98160	1 1/4	M40 x 1,5	920523	36	91027	1 1/4" 905767	96880
91236	97175			91250	98154	91243	97668			98161	1 1/2	M50 x 1,5	920524	42	91028	1 1/2" 905768	98364
91237	96252			91251	98155	91244	97811				2	M63 x 1,5	920525	48	91029	2" 905769	905027
											2 1/2						905028
											3						905029
											4						905030

SELECTION GUIDE ANACONDA SEALTITE/CONDUIT GLAND

ANACONDA SEALTITE

TUBE CONNECTOR

T&B tube connector straight

EF	Small-VPE		OR	HTDL	HC	HCX	ZHLS	HFX	Shieldtite EMP	Tube NW	Size		Size		Size		suitable Inner protec- tion sleeve
	grey	black									grey	black	Metric	PG	NPT		
91229	96939									1/4	M16 x 1,5	98173					
											M20 x 1,5	98174			1/4"	98190	
91230	96248	94915	94930				94988	94994		5/16	M16 x 1,5	98171			3/8"	98191	
											M20 x 1,5	98172	9	90684			
91231	96249	94916	94931	91245	98149	91238	94735	94989	94995	3/8	M16 x 1,5	98175	11	90685	1/2"	96737	
										3/8	M20 x 1,5	98176	13,5	90686	1/2"		
91232	97153	94917	94932	91246	98150	91239	96410	94990	94996	1/2	M20 x 1,5	98177	16	90687	1/2"	90810	
91233	96718	94918	94933	91247	98151	91240	96954	94991	94997	3/4	M25 x 1,5	98178	21	90688	3/4"	96465	
91234	96250			91248	98152	91241	97945	94992	94998	1	M32 x 1,5	98179	29	90689	1"	96205	
91235	96251			91249	98153	91242	96247	94993	94999	1 1/4			36	90690	1 1/4"	98192	
91236	97175			91250	98154	91243	97668			1 1/2			42	90691	1 1/2"	96206	
91237	96252			91251	98155	91244	97811			2			48	90692	2"	96207	
										2 1/2					2 1/2"	98193	
										3					3"	98194	
										4					4"	98195	

T&B tube connector elbow 45°

EF	Small-VPE		OR	HTDL	HC	HCX	ZHLS	HFX	Shieldtite EMP	Tube NW	Size		Size		Size		suitable Inner protec- tion sleeve
	grey	black									grey	black	Metric	PG	NPT		
91229	96939									1/4							
91230	96248	94915	94930				94988	94994		5/16							
91231	96249	94916	94931	91245	98149	91238	94735	94989	94995	3/8	M16 x 1,5	98180	11	90693	1/2"	96739	
										3/8	M20 x 1,5	98181	13,5	90694			
91232	97153	94917	94932	91246	98150	91239	96410	94990	94996	1/2	M20 x 1,5	98182	16	90695	1/2"	96208	
91233	96718	94918	94933	91247	98151	91240	96954	94991	94997	3/4	M25 x 1,5	98183	21	90696	3/4"	96209	
91234	96250			91248	98152	91241	97945	94992	94998	1	M32 x 1,5	98184	29	90697	1"	96210	
91235	96251			91249	98153	91242	96247	94993	94999	1 1/4			36	90698	1 1/4"	98196	
91236	97175			91250	98154	91243	97668			1 1/2			42	90699	1 1/2"	98197	
91237	96252			91251	98155	91244	97811			2			48	90700	2"	96211	
										2 1/2					2 1/2"	98198	
										3					3"	98199	
										4					4"	98200	

T&B tube connector elbow 90°

EF	Small-VPE		OR	HTDL	HC	HCX	ZHLS	HFX	Shieldtite EMP	Tube NW	Size		Size		Size		suitable Inner protec- tion sleeve
	grey	black									grey	black	Metric	PG	NPT		
91229	96939									1/4							
91230	96248	94915	94930				94988	94994		5/16							
91231	96249	94916	94931	91245	98149	91238	94735	94989	94995	3/8	M16 x 1,5	98185	11	90701	1/2"	97300	
										3/8	M20 x 1,5	98186	13,5	90702			
91232	97153	94917	94932	91246	98150	91239	96410	94990	94996	1/2	M20 x 1,5	98187	16	90703	1/2"	96212	
91233	96718	94918	94933	91247	98151	91240	96954	94991	94997	3/4	M25 x 1,5	98188	21	90704	3/4"	96213	
91234	96250			91248	98152	91241	97945	94992	94998	1	M32 x 1,5	98189	29	90705	1"	97671	
91235	96251			91249	98153	91242	96247	94993	94999	1 1/4			36	90706	1 1/4"	98291	
91236	97175			91250	98154	91243	97668			1 1/2			42	90707	1 1/2"	96214	
91237	96252			91251	98155	91244	97811			2			48	90708	2"	96215	
										2 1/2					2 1/2"	98292	
										3					3"	98293	
										4					4"	98294	

SELECTION GUIDE ANACONDA SEALTITE/CONDUIT GLAND

ANACONDA SEALTITE

TUBE CONNECTOR

T&B tube connector elbow 90°

EF	Small-VPE		OR	HTDL	HC	HCX	ZHLS	HFX	Shieldtite EMP	Tube NW	Size Metric		Size PG		Size NPT		suitable Inner protec- tion sleeve
	grey	black									grey	black					
91229	96939									1/4							
91230	96248	94915	94930				94988	94994		5/16							
91231	96249	94916	94931	91245	98149	91238	94735	94989	94995	98156	3/8	M16 x 1,5 98185	11 90701	1/2"	97300		
											3/8	M20 x 1,5 98186	13,5 90702				
91232	97153	94917	94932	91246	98150	91239	96410	94990	94996	98157	1/2	M20 x 1,5 98187	16 90703	1/2"	96212		
91233	96718	94918	94933	91247	98151	91240	96954	94991	94997	98158	3/4	M25 x 1,5 98188	21 90704	3/4"	96213		
91234	96250			91248	98152	91241	97945	94992	94998	98159	1	M32 x 1,5 98189	29 90705	1"	97671		
91235	96251			91249	98153	91242	96247	94993	94999	98160	1 1/4		36 90706	1 1/4"	98291		
91236	97175			91250	98154	91243	97668			98161	1 1/2		42 90707	1 1/2"	96214		
91237	96252			91251	98155	91244	97811				2		48 90708	2"	96215		
											2 1/2			2 1/2"	98292		
											3			3"	98293		
											4			4"	98294		

LT-CNP

CNP	Tube NW	Size NPT	
91259	3/8	1/2"	904907
91260	1/2	1/2"	904908
91261	3/4	3/4w	904909
91262	1	1"	904910
91263	1 1/4	1 1/4"	904911
91264	1 1/2	1 1/2"	904912
91265	2	2"	904913

LT-CNP-E

CNP	Tube NW	Size Metric	
91259	3/8	M16 x 1,5 905913	
91260	1/2	M20 x 1,5 905914	
91261	3/4	M25 x 1,5 905058	
91262	1	M32 x 1,5 905059	
91263	1 1/4	M40 x 1,5 905060	
91264	1 1/2	M50 x 1,5 905061	
	1 1/2	M63 x 1,5 905062	
91265	2	M63 x 1,5 905063	

SELECTION TABLE - FLEXIBLE PROTECTION TUBE / CONDUIT GLAND

FLEXIBLE PROTECTION TUBE

TUBE CONNECTOR

USK, plastic, high protection classification

S	S-PU		K	Tube Outer ø mm	Size Metric			Size PG	Small-VPE		
	Small-VPE	Small-VPE			Small-VPE	Small-VPE	Small-VPE				
91219	91270	90464	94870		10	M10 x 1,0	97594	93460	7	90664	93450
91220	91271	90465	94871	91209	14	M12 x 1,5	97595	93461	9	90665	93451
91221	91272	90466	94872	91210	17	M16 x 1,5	97596	93462	11	90666	93452
91222	91273	90467	94873	91211	19				13,5	90667	93453
91223	91274	90468	94874	91212	21	M20 x 1,5	97597	93463	16	90668	93454
91224	91275	90469	94875	91213	27	M25 x 1,5	97598	93464	21	90669	93455
91225	91276	90470	94876	91214	36	M32 x 1,5	97599	93465	29	90670	93456
91226	91277	90471	94877	91215	45	M40 x 1,5	97600	93466	36	90671	93457
				91216	52						
91228	91279	90473	94879	91217	56	M50 x 1,5	97601	93467	48	90673	93458

LK-I, Plastic

S	S-PU		K	Tube Outer ø mm	Size Metric			Size PG	Small-VPE		
	Small-VPE	Small-VPE			Small-VPE	Small-VPE	Small-VPE				
91219	91270	90464	94870		10	M10 x 1,0	97602	93480	7	90720	93470
91220	91271	90465	94871	91209	14	M12 x 1,5	97603	93481	9	90721	93471
91221	91272	90466	94872	91210	17	M16 x 1,5	97604	93482	11	90722	93472
91222	91273	90467	94873	91211	19				13,5	90723	93473
91223	91274	90468	94874	91212	21	M20 x 1,5	97605	93483	16	90724	93474
91224	91275	90469	94875	91213	27	M25 x 1,5	97606	93484	21	90725	93475
91225	91276	90470	94876	91214	36	M32 x 1,5	97607	93485	29	90726	93476
91226	91277	90471	94877	91215	45	M40 x 1,5	97608	93486	36	90727	93477
				91216	52						
91228	91279	90473	94879	91217	56	M50 x 1,5	97609	93487	48	90729	93478

US, brass, high protection classification

S	S-PU		K	Tube Outer ø mm	Size Metric			Size PG	Small-VPE		suitable Inner protection sleeve EEK	
	Small-VPE	Small-VPE			Small-VPE	Small-VPE	Small-VPE					
91219	91270	90464	94870		10	M10 x 1,0	98331	93530	7	98322	93520	96342
91220	91271	90465	94871	91209	14	M12 x 1,5	98332	93531	9	98323	93521	96449
91221	91272	90466	94872	91210	17	M16 x 1,5	98333	93532	11	98324	93522	96343
91222	91273	90467	94873	91211	19				13,5	98325	93523	96450
91223	91274	90468	94874	91212	21	M20 x 1,5	98334	93533	16	98326	93524	96451
91224	91275	90469	94875	91213	27	M25 x 1,5	98335	93534	21	98327	93525	96344
91225	91276	90470	94876	91214	36	M32 x 1,5	98336	93535	29	98328	93526	96447
91226	91277	90471	94877	91215	45	M40 x 1,5	98337	93536	36	98329	93527	96345
				91216	52							
91228	91279	90473	94879	91217	56	M50 x 1,5	98338	93537	48	98330	93528	96347

LI, brass, with retaining ring

S	S-PU		K	Tube Outer ø mm	Size Metric			Size PG	Small-VPE		
	Small-VPE	Small-VPE			Small-VPE	Small-VPE	Small-VPE				
91219	91270	90464	94870		10	M10 x 1,0	97619	93610	7	90730	93600
91220	91271	90465	94871	91209	14	M12 x 1,5	97620	93611	9	90731	93601
91221	91272	90466	94872	91210	17	M16 x 1,5	97621	93612	11	90732	93602
91222	91273	90467	94873	91211	19				13,5	90733	93603
91223	91274	90468	94874	91212	21	M20 x 1,5	97622	93613	16	90734	93604
91224	91275	90469	94875	91213	27	M25 x 1,5	97623	93614	21	90735	93605
91225	91276	90470	94876	91214	36	M32 x 1,5	97624	93615	29	90736	93606
91226	91277	90471	94877	91215	45	M40 x 1,5	97625	93616	36	90737	93607
				91216	52						
91228	91279	90473	94879	91217	56	M50 x 1,5	97626	93617	48	90738	93608

SELECTION TABLE - FLEXIBLE PROTECTION TUBE / CONDUIT GLAND

FLEXIBLE PROTECTION TUBE

TUBE CONNECTOR

US, brass, high protection classification

M			Tube Outer ø mm	Size Metric	Size PG	suitable Inner protection sleeve EEM
97014			10	M10 x 1,0 98233	7 98206	906006
97015			14	M12 x 1,5 98234	9 98207	906007
97016			17	M16 x 1,5 98235	11 98208	906008
97017			19		13,5 98209	906009
97018			21	M20 x 1,5 98236	16 98210	906010
97019			27	M25 x 1,5 98237	21 98211	906011
97020			36	M32 x 1,5 98238	29 98212	906012
97021			45	M40 x 1,5 98239	36 98213	906013
			52			
97022			56	M50 x 1,5 98240	48 98214	906014

LI, brass, with retaining ring

M			Tube Outer ø mm	Size Metric	Small-VPE	Size PG	Small-VPE	
97014			10		97619 93610	7	90730	93600
97015			14	M12 x 1,5	97620 93611	9	90731	93601
97016			17	M16 x 1,5	97621 93612	11	90732	93602
97017			19			13,5	90733	93603
97018			21	M20 x 1,5	97622 93613	16	90734	93604
97019			27	M25 x 1,5	97623 93614	21	90735	93605
97020			36	M32 x 1,5	97624 93615	29	90736	93606
97021			45	M40 x 1,5	97625 93616	36	90737	93607
			52					
97022			56	M50 x 1,5	97626 93617	48	90738	93608

US, brass, high protection classification

SPR-AS	Small-VPE		Tube Outer ø mm	Size Metric	Small-VPE	Size PG	Small-VPE	suitable Inner protection sleeve EEM	
97023	94880		10	M10 x 1,0 98241	93570	7	98215	93560	99510
97024	94881		14	M12 x 1,5 98242	93571	9	98216	93561	99511
97025	94882		17	M16 x 1,5 98243	93572	11	98217	93562	99512
97026	94883		19			13,5	98218	93563	99513
97027	94884		21	M20 x 1,5 98244	93573	16	98219	93564	99514
97028	94885		27	M25 x 1,5 98245	93574	21	98220	93565	99515
97029	94886		36	M32 x 1,5 98246	93575	29	98221	93566	99516
97030	94887		45	M40 x 1,5 98247	93576	36	98222	93567	99517
			52						
97031	94888		56	M50 x 1,5 98248	93577	48	98223	93568	99518

LI, brass, with retaining ring

SPR-AS	Small-VPE		Tube Outer ø mm	Size Metric	Small-VPE	Size PG	Small-VPE	
97023	94880		10	M10 x 1,0	97619 93610	7	90730	93600
97024	94881		14	M12 x 1,5	97620 93611	9	90731	93601
97025	94882		17	M16 x 1,5	97621 93612	11	90732	93602
97026	94883		19			13,5	90733	93603
97027	94884		21	M20 x 1,5	97622 93613	16	90734	93604
97028	94885		27	M25 x 1,5	97623 93614	21	90735	93605
97029	94886		36	M32 x 1,5	97624 93615	29	90736	93606
97030	94887		45	M40 x 1,5	97625 93616	36	90737	93607
			52					
97031	94888		56	M50 x 1,5	97626 93617	48	90738	93608

SELECTION TABLE - FLEXIBLE PROTECTION TUBE / CONDUIT GLAND

FLEXIBLE PROTECTION TUBE

TUBE CONNECTOR

US, brass, high protection classification

SPR-PVC-AS		Small-VPE		S-PU-AS	Tube Outer ø mm	Size Metric			Size PG	Small-VPE	suitable Inner protection sleeve EEK	
grey	black	grey	black					Small-VPE				
97032	97702	94890	94934	97793	10	M10 x 1,0	98249	93590	7	98224	93580	97580
97033	97685	94935	94891	97794	14	M12 x 1,5	98250	93591	9	98225	93581	97680
97034	97703	94892	94936	91131	17	M16 x 1,5	98251	93592	11	98226	93582	97691
97035	97704	94893	94937		19				13,5	98227	93583	97692
97036	97705	94938	94894	94738	21	M20 x 1,5	98252	93593	16	98228	93584	97693
97037	97706	94895	94939	97941	27	M25 x 1,5	98253	93594	21	98229	93585	97681
97038	97707	94896	94940	94714	36	M32 x 1,5	98254	93595	29	98230	93586	97682
97039	97708	94941	94897	90399	45	M40 x 1,5	98255	93596	36	98231	93587	97694
					52							
97040	97709	94898	94942	94739	56	M50 x 1,5	98256	93597	48	98232	93588	97684

LI, brass, with retaining ring

SPR-PVC-AS		Small-VPE		S-PU-AS	Tube Outer ø mm	Size Metric			Size PG	Small-VPE	suitable Inner protection sleeve EEK	
grey	black	grey	black					Small-VPE				
97032	97702	94890	94934	97793	10	M10 x 1,0	97619	93610	7	90730	93600	
97033	97685	94935	94891	97794	14	M12 x 1,5	97620	93611	9	90731	93601	
97034	97703	94892	94936	91131	17	M16 x 1,5	97621	93612	11	90732	93602	
97035	97704	94893	94937		19				13,5	90733	93603	
97036	97705	94938	94894	94738	21	M20 x 1,5	97622	93613	16	90734	93604	
97037	97706	94895	94939	97941	27	M25 x 1,5	97623	93614	21	90735	93605	
97038	97707	94896	94940	94714	36	M32 x 1,5	97624	93615	29	90736	93606	
97039	97708	94941	94897	90399	45	M40 x 1,5	97625	93616	36	90737	93607	
					52							
97040	97709	94898	94942	94739	56	M50 x 1,5	97626	93617	48	90738	93608	

US, brass, high protection classification

SPR-EDU-AS	Small-VPE		Tube Outer ø mm	Size Metric			Size PG	suitable Inner protection sleeve EEK	
97584	94920		10	M10 x 1,0	905989	7	905997	97580	
97585	94921		14	M12 x 1,5	905990	9	905998	97680	
97586	94922		17	M16 x 1,5	905991	11	905999	97691	
97510	94923		19			13,5	906000	97692	
97377	94924		21	M20 x 1,5	905992	16	906001	97693	
97378	94925		27	M25 x 1,5	905993	21	906002	97681	
97379	94926		36	M32 x 1,5	905994	29	906003	97682	
96784	94927		45	M40 x 1,5	905995	36	906004	97694	
			52						
97587	94928		56	M50 x 1,5	905996	48	906005	97684	

LI, brass, with retaining ring

SPR-EDU-AS	Small-VPE		Tube Outer ø mm	Size Metric			Size PG	Small-VPE	
97584	94920		10	M10 x 1,0	97619	93610	7	90730	93600
97585	94921		14	M12 x 1,5	97620	93611	9	90731	93601
97586	94922		17	M16 x 1,5	97621	93612	11	90732	93602
97510	94923		19				13,5	90733	93603
97377	94924		21	M20 x 1,5	97622	93613	16	90734	93604
97378	94925		27	M25 x 1,5	97623	93614	21	90735	93605
97379	94926		36	M32 x 1,5	97624	93615	29	90736	93606
96784	94927		45	M40 x 1,5	97625	93616	36	90737	93607
			52						
97587	94928		56	M50 x 1,5	97626	93617	48	90738	93608

SELECTION TABLE - FLEXIBLE PROTECTION TUBE / CONDUIT GLAND

FLEXIBLE PROTECTION TUBE

TUBE CONNECTOR

LT-E-UI straight, stainless steel

UI	Tube Outer ø mm	Size Metric		Size PG	Size NPT
905804	12,5	M16 x 1,5 905812	M20 x 1,5 905814	11 905820	1/2" 905826
905805	16	M16 x 1,5 905813	M20 x 1,5 905815	11 905821	1/2" 905827
905806	21	M20 x 1,5 905816		16 905822	1/2" 905828
905807	26	M25 x 1,5 905817		21 905823	3/4" 905829
905808	30	M32 x 1,5 905818		29 905824	1" 905830
905809	39	M40 x 1,5 905819		36 905825	1 1/4" 905831
905810	44,4				
905811	55,7				

LT-E-UI elbow 90°, stainless steel

UI	Tube Outer ø mm	Size Metric		Size PG	Size NPT
905804	12,5	M16 x 1,5 905832	M20 x 1,5 905834	11 905838	1/2" 905843
905805	16	M16 x 1,5 905833	M20 x 1,5 905835	11 905839	1/2" 905844
905806	21	M20 x 1,5 905836		16 905840	1/2" 905845
905807	26	M25 x 1,5 905837		21 905841	3/4" 905846
905808	30			29 905842	1" 905847
905809	39				
905810	44,4				
905811	55,7				

Selection table - Cables for energy drag chains

Max. movement distance in m
(10 m to 25-wire)

Min. bending radius (D=outerØ)

Speed max. m/s

Acceleration max. m/s²
min. in Mio.

Page*

Control cables, screened and unscreened	5	10	15	30	100	450	5xD	7,5xD	10xD	12,5xD	15xD	2	3	4	5	10	50	9	10	11	
JZ-602 RC-C-PUR	x	x	x						x			x	x			x		x			436
Single 602-RC-J / -O	x							x				x				x		x			501
Single 602-RC-CY-J / -O	x							x				x				x		x			502
JZ-602 RC	x	x						x				x				x		x			423
JZ-602 RC-PUR	x	x	x					x				x	x			x		x			430
JZ-602 RC-CY	x	x							x			x				x		x			427
JZ-602 RC-C-PUR	x	x	x						x			x	x			x		x			436
JZ-HF	x	x						x				x				x		x			160
JZ-HF-CY	x	x							x			x				x		x			163
MULTIFLEX® 600	x	x										x				x		x			424
MULTIFLEX® 600-C	x	x										x				x		x			428
PURö-JZ-HF	x	x	x					x				x	x			x		x	x		167
PURö-JZ-HF-YCP	x	x	x						x			x	x			x		x	x		172
MULTIFLEX 512®-PUR	x	x	x	x	x		x					x	x	x		x		x	x	x	169
MULTIFLEX 512®-C-PUR	x	x	x	x	x			x				x	x	x		x		x	x	x	174
MULTIFLEX 512®-PUR UL/CSA	x	x	x	x	x		x					x	x	x		x		x	x	x	431
MULTIFLEX 512®-C-PUR UL/CSA	x	x	x	x	x			x				x	x	x		x		x	x	x	439
JZ-HF-FCY	x	x							x			x				x		x			426
PURö-JZ-HF-FCP	x	x	x						x			x	x			x		x			435
MULTISPEED® 600-PUR-J / -O	x	x	x	x	x	x	x					x	x	x	x	x	x	x	x	x	504
MULTISPEED® 600-C-PUR-J / -O	x	x	x	x	x	x	x					x	x	x	x	x	x	x	x	x	505
MULTISPEED® 500-PVC	x	x	x	x	x			x				x	x	x	x	x	x	x			162
MULTISPEED® 500-PVC UL/CSA	x	x	x	x	x			x				x	x	x	x	x	x	x			425
MULTISPEED® 500-PUR	x	x	x	x	x	x		x				x	x	x	x	x	x	x	x	x	171
MULTISPEED® 500-PUR UL/CSA	x	x	x	x	x	x		x				x	x	x	x	x	x	x	x	x	433
MULTISPEED® 500-TPE	x	x	x	x	x	x	x					x	x	x	x	x	x	x	x	x	177
MULTISPEED® 500-TPE UL/CSA	x	x	x	x	x	x	x					x	x	x	x	x	x	x	x	x	441
MULTISPEED® 500-C-PVC	x	x	x	x	x			x				x	x	x	x	x	x	x			165
MULTISPEED® 500-C-PVC UL/CSA	x	x	x	x	x			x				x	x	x	x	x	x	x			429
MULTISPEED® 500-C-PUR	x	x	x	x	x	x		x				x	x	x	x	x	x	x	x	x	176
MULTISPEED® 500-C-PUR UL/CSA	x	x	x	x	x	x		x				x	x	x	x	x	x	x	x	x	439
MULTISPEED® 500-C-TPE	x	x	x	x	x	x	x					x	x	x	x	x	x	x	x	x	179
MULTISPEED® 500-C-TPE UL/CSA	x	x	x	x	x	x	x					x	x	x	x	x	x	x	x	x	443
SUPERTRONIC®-PVC	x							x				x				x		x			187
SUPERTRONIC®-C-PVC	x								x			x				x		x			188
SUPERTRONIC®-310-PVC	x							x				x				x		x			445
SUPERTRONIC®-310-C-PVC	x								x			x				x		x			446
SUPERTRONIC®-PURö	x							x				x	x			x		x			189

*Further technical details can be found in the product pages of the catalogue Cables, wires & accessories, Issue 27. This table shows main applications.

In case of moving cables at higher speeds, over long distances or higher cycling rates please contact our Technical support Tel. +49 7150 9209-133

or techsupport@helukabel.de. A cycle is a double stroke. They have been determined in a test lab on representative dimensions of the series. The cycle number is only possible when installed correctly and professional. (see installation instruction for energy drag chains p. 286-287.)

Max. movement distance in m
(10 m to 25-wire)

Min. bending radius (D=outerØ)

Speed max. m/s

Acceleration max. m/s²

Number of cycles
min. in Mio.

Page*

Control cables, screened and unscreened	5	10	15	30	100	450	5xD	7,5xD	10xD	12,5xD	15xD	2	3	4	5	10	50	9	10	11		
SUPERTRONIC®-C-PURø	x	x	x					x					x	x	x		x		x			190
SUPERTRONIC®-330 PURø	x	x	x				x						x	x	x		x		x	x	x	447
SUPERTRONIC®-330 C-PURø	x	x	x					x					x	x	x		x		x	x	x	449
SUPER-PAAR-TRONIC®-C-PUR	x	x	x	x					x				x	x	x		x	x	x			191
SUPER-PAAR-TRONIC 340-C-PUR	x	x	x	x					x				x	x	x		x	x	x	x	x	451
MULTISPEED®-TRONIC-PUR	x	x	x	x	x	x		x					x	x	x	x	x	x	x	x	x	448
MULTISPEED®-TRONIC-C-PUR	x	x	x	x	x	x		x					x	x	x	x	x	x	x	x	x	450
TOPGEBER 512 PUR	x	x	x	x					x				x	x	x		x	x	x	x	x	470
Tachofeedback-cable-C-PUR	x	x	x	x					x				x	x	x		x	x	x			203
Incremental encoder cable C-PUR	x	x	x	x					x				x	x	x		x	x	x			203
TOPFLEX PUR	x	x	x	x					x				x	x	x		x		x			203
TOPSERV® 109 PUR	x	x	x	x				x					x	x	x		x		x	x	x	468
TOPSERV® 113 PUR	x	x	x	x				x					x	x	x		x		x	x	x	468
TOPSERV® 121 PUR	x	x	x	x				x					x	x	x		x		x	x	x	468
TOPFLEX® 300	x							x					x				x		x			321
TOPFLEX® 301	x							x					x				x		x	x		506
TOPFLEX® 301-C	x							x					x				x		x	x		506
TOPFLEX® 304	x						x						x				x		x			503
TOPFLEX® 304-C	x						x						x				x		x			503
SENSORFLEX® H	x	x	x	x				x					x	x	x	x	x		x	x	x	192
TOPSERV® 600 VFD	x	x						x					x				x		x			472
TOPSERV® 650 VFD	x	x						x					x				x		x			473
TOPFLEX® 611-PUR	x	x	x	x				x					x	x	x		x	x	x	x	x	199
TOPFLEX® 611-C-PUR	x	x	x	x					x				x	x	x		x	x	x	x	x	200
TOPSERV® 110	x	x	x	x				x					x	x			x		x	x	x	201
TOPSERV® 120	x	x	x	x				x					x	x			x		x	x	x	201
BIOFLEX-500®-JZ-HF	x	x	x	x	x				x				x	x	x		x		x	x	x	181
BIOFLEX-500®-JZ-HF-C	x	x	x	x	x						x		x	x	x		x		x	x	x	182
KOMPOSPEED® 600	x	x	x	x	x		x						x	x	x		x		x	x	x	322
KOMPOSPEED® 600-C	x	x	x	x	x			x					x	x	x		x		x	x	x	322
KOMPOSPEED® JZ-HF-500	x	x	x	x	x			x					x	x	x		x		x	x		184
KOMPOSPEED® JZ-HF-500-C	x	x	x	x	x			x					x	x	x		x		x	x		185
SHIFFLEX 512	x	x	x	x	x			x					x	x	x		x		x	x	x	933
SHIFFLEX 330	x	x	x	x	x			x					x	x	x		x		x	x	x	934
SHIFFLEX 340	x	x	x	x	x			x					x	x	x		x		x	x	x	935
SHIFFLEX 109	x	x	x	x	x			x					x	x	x		x		x	x	x	936
SHIFFLEX 113	x	x	x	x	x			x					x	x	x		x		x	x	x	938
SHIFFLEX 121	x	x	x	x	x			x					x	x	x		x		x	x	x	939

*Further technical details can be found in the product pages of the catalogue Cables, wires & accessories, Issue 27. This table shows main applications.

In case of moving cables at higher speeds, over long distances or higher cycling rates please contact our Technical support Tel. +49 7150 9209-133 or techsupport@helukabel.de. A cycle is a double stroke. They have been determined in a test lab on representative dimensions of the series. The cycle number is only possible when installed correctly and professional. (see installation instruction for energy drag chains p. 286-287.)

SELECTION GUIDE

Application	Technical data						Series	Type
	Ampacity (in A)	Nominal voltage (in V)	Pin arrangement	Contact diameter (in mm)	Max. termination diameter (in mm ²)	Max. cable clamp diameter (in mm) special sizes on request		
Signal	5	63	12	1	1	4.5 - 12	615	on request
	5 / 14	63	15 (12+3)	1	0.75/1.5	4.5 - 12		on request
	9	40	7	1	1	4 - 8		on request
Signal	7	32	12	1	1	3.5 - 12	617	M17
	3.6	63	17	0.6	0.5	3.5 - 12		M17
Signal	20	32	6/7	2	2.5	3.5 - 17	623	M23
	10	160	9 (8+1)	1/2	1/2.5	3.5 - 17		M23
	10	160	9	1	1	3.5 - 17		M23
	9	125	10	1	1	3.5 - 17		M23
	7	160	12	1	1	3.5 - 17		M23
	7	125	17	1	1	3.5 - 17		M23
	7	63	19 (16+3)	1/1.5	1/1.5	3.5 - 17		M23
	7	63	19 (15+4)	1	1	4.2 - 17		twintec B
Signal	9	60	26	1	1.5	4.2 - 17	627	M27
Power	14/3.6	630/63	9 (4+5)	1	0.75/1.5	4.5 - 12	915	on request
Power	20	630	4	1.5	2.5	3.5 - 12	917	M17
	14	630	7	1	1.5	3.5 - 12		M17
	14/3.6	630/63	9 (4+5)	1	0.75/1.5	3.5 - 12		M17
	64	630	1	3.6	10	3.5 - 12		singletec
Power	30	630	6	2	4	4.2 - 17	623	M23
	30	630/250	8 (4+4)	2/1	4/1.5	4.2 - 17		M23
	30	630/250	9 (4+5)	2/1	4/1.5	4.2 - 17		M23
	200	630	1	8	50	4.2 - 17		singletec
Power	66	630	3	3	16	4.2 - 14.5	926	eltec
Power	75/30	630/250	6 (4+2)	3.6/2	16/4	7 - 25	940	M40
	75/30	630/250	8 (4+4)	3.6/2	16/4	7 - 25		M40
	75/30	630/250	9 (4+5)	3.6/2	16/4	7 - 25		M40
Power	150/12	630/250	8 (4+4)	10/1.6	50/1.5	17 - 36	958	M58

■ INSTRUCTIONS FOR ASSEMBLY OF CABLE LUGS AND JOINTS – GENERAL

1. The measurements of the cable lugs/joints as well as their cross-section assignment have to be taken from the catalogue.
2. The end of the cable has to be cut right-angled to the joint and to be stripped ca. 10 % corresponding to the length of the cable lug receptacle. (The receptacle elongates a bit during the compression)
3. The wire ends have to be cleaned thoroughly of dirt and oxide rests prior to the compression. Sector wires have to be rounded.
4. The wire is pushed as far as it will go in the cable lug receptacle, or rather to the middle of the joint.
5. Prior to the compression it has to be checked if the wire and the cable lug, or rather the joint, have the same cross-section marking and match according to the catalogue.
6. It has to be detected if the compression tool is ready for the montage with the right compression insert.
7. The compression process, with cable lug and joint, happens from the end of the cable in the direction of the end of the receptacle (see sketch).

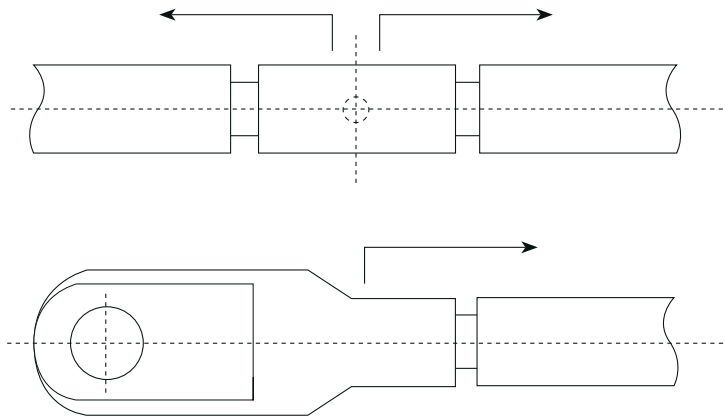

The number of compressions is based on the following tables.

■ COMPRESSION INSTRUCTION

Min. number of required compressions while manufacturing HELU-S-RK-tubular cable lugs and HELU-S-SV-compression joints (WM-compression):

Cross-section in mm	Compression amount x width	HWW 6/50 907612	HWW 10/120 907613	HMPi 20 907614	HHPi 20 908286	HAP 60-2 908494
6	1 x 5 mm					
	1 x 7 mm			•	•	•
10	1 x 5 mm	•	•			
	1 x 7 mm			•	•	•
16	2 x 5 mm	•	•			
	1 x 7 mm			•	•	•
25	2 x 5 mm	•	•			
	1 x 12 mm			•	•	•
35	2 x 5 mm	•	•	•	•	•
	1 x 10 mm					
	1 x 12 mm					
50	2 x 5 mm	•	•	•	•	•
	1 x 12 mm					
70	2 x 5 mm		•	•	•	•
	1 x 12 mm					
95	2 x 5 mm		•	•	•	•
	1 x 12 mm					
120	3 x 5 mm		•	•	•	•
	2 x 7 mm					
	1 x 12 mm					
150	3 x 5 mm			•	•	•
	2 x 7 mm					
185	3 x 5 mm			•	•	•
	2 x 7 mm					
	2 x 10 mm					
240	3 x 5 mm			•	•	•
	3 x 7 mm					
	2 x 13 mm					
300	4 x 5 mm			•	•	•
	3 x 7 mm					
	2 x 13 mm					

Important : Please note the "Instruction for Assembly of Cable Lugs and Joints - General" when producing compressions.
Joints : Minimum number of necessary compressions per side.

■ COMPRESSION INSTRUCTION

Min. number of required compressions when using CU tubular cable lug of series HELU-S-PK-CU-DIN- and HELU-S-PV-CU-DIN

Cross-section in mm	Code type	Compression Width	HMPi 20 907614	HHPi 20 908286	HAP 60-2 908494
6	5	1 x 5 mm			
		1 x 7 mm	•	•	•
10	6	1 x 5 mm			
		1 x 7 mm	•	•	•
16	8	2 x 5 mm			
		1 x 12 mm	•	•	•
25	10	2 x 5 mm			
		1 x 12 mm	•	•	•
35	12	2 x 5 mm	•	•	
		1 x 10 mm			
		1 x 12 mm			•
50	14	3 x 5 mm	•	•	
		1 x 12 mm			•
70	16	3 x 5 mm	•	•	
		1 x 12 mm			•
95	18	3 x 5 mm	•	•	
		4 x 5 mm	• * for railway earthing		
		2 x 10 mm			•
120	20	3 x 5 mm	• * for railway earthing		
		4 x 5 mm	•	•	
		2 x 10 mm			•
150	22	4 x 5 mm	•	•	•
		2 x 10 mm			
185	25	4 x 5 mm	•	•	•
		2 x 10 mm			
240	28	4 x 5 mm	•	•	•
		2 x 13 mm			
300	32	4 x 5 mm	•	•	
		4 x 7 mm			•
		2 x 13 mm			

Important : Please note the "Instruction for Assembly of Cable Lugs and Joints - General" when producing compressions.
 Joints : Minimum number of necessary compressions per side.

■ COMPRESSION INSTRUCTION

Min. number of required compressions when using HELUKABEL tubular cable lug of and compression joints of the Aluminium series HELU-S-PK-AL-DIN and HELU-S-PV-AL-DIN.

Cross-section in mm	Code type	Compression amount x width	HMPi 20	HHPi 20 908286	HAP 60-2 908494
10	10	2 x 5 mm 1 x 12 mm	•	•	•
16	10	3 x 5 mm 1 x 12 mm	•	•	•
	12	3 x 5 mm 1 x 10 mm 1 x 12 mm	•	•	•
25	12	4 x 5 mm 1 x 10 mm 2 x 12 mm	•	•	•
35	14	5 x 5 mm 2 x 12 mm	•	•	•
50	16	5 x 5 mm 2 x 12 mm	•	•	•
70	18	6 x 5 mm 3 x 10 mm	•	•	•
95	22	6 x 5 mm 3 x 10 mm	•	•	•
120	22	6 x 5 mm 3 x 10 mm	•	•	•
150	25	6 x 5 mm 3 x 10 mm	•	•	•
185	28	6 x 5 mm 3x13 mm	•	•	•
240	32	6 x 5 mm 5 x 7 mm 3x13 mm	•	•	•

Important : Please note the "Instruction for Assembly of Cable Lugs and Joints - General" when producing compressions.
Compression joints : Min. number of required compressions per side

Glossary of Cables and Wires

Type	Page	Type	Page
802/0	445	CU	302
802/1	446	CV Compact	267 – 268
803/0, 803/5, 804	444	DEB 0560	447
806/0, 806/4, 806/8	449	DUO	385
807/1, 807/2	450	DUO Crimp 300	442
Adapter hexagonal	111 – 112	DUO Stripper 200	441
Adapter PA	60	E	356
Adapter PA-ATEX	164 – 165	E WM	372
Adapter round	113 – 114	EEK	255
ADI	380 – 381	EEM	256
ADI-B	382	EES	283
ADI-K	384	EKI	325
ADU	387	Electricians scissors	136, 432
AGDR-PE	68	ERG 50, ERG 120	465
Anaconda Sealtite® CNP	265	ERG 740	461 – 462
Anaconda Sealtite® EF	258	ESD-ADI	383
Anaconda Sealtite® HC	261	ESD-DUO	386
Anaconda Sealtite® HCX	262	EW PA-ATEX	166
Anaconda Sealtite® HFX	264	EW round	115
Anaconda Sealtite® HTDL	260	EW-PA	61
Anaconda Sealtite® NMFG-Clean	266	FLEV-S	336
Anaconda Sealtite® OR	259	HELUcond CO-PA	230
Anaconda Sealtite® ZHLS	263	HELUcond CO-PP	231
AV	329	HELUcond PA12	197
B	397 – 399	HELUcond PA6	195
BL-H	69	HELUcond PA6-L	193
BL-W	70	HELUcond PA6-S	194
BS	358	HELUcond PA6-UL	196
BW	183	HELUcond PE	192
Cable grips	483 – 485	HELUcond PP	198
Cable stripper for vulcanized semi conductive layer HFBS	470	HELUFast	171 – 174
Chamfer cutter HUFs	472	HELUquick	199 – 200
CMP	314	HELU-S-PE-SK	460
Copper band	137	HELU-S-PE-WM	459
COS	233	HELU-S-PK-AL/CU	415 – 416
COV	232	HELU-S-PK-AL-DIN	414
CT5	466	HELU-S-PK-CU	410 – 411
		HELU-S-PK-CU-DIN	412 – 413

Glossary of Cables and Wires

Type	Page	Type	Page
HELU-S-PV-AL/CU	422 – 423	HELUTOP® HT-MFDE	32
HELU-S-PV-AL-DIN	421	HELUTOP® HT-MS	74 – 75
HELU-S-PV-CU-DIN	420	HELUTOP® HT-MS c Plus	178
HELU-S-RK-45-CU-UL	403 – 404	HELUTOP® HT-MS Plus	177
HELU-S-RK-90-CU-UL	405 – 406	HELUTOP® HT-MS-EX-d	159
HELU-S-RK-CU	400	HELUTOP® HT-MS-EX-d / e4	161
HELU-S-RK-CU-UL	401 – 402	HELUTOP® HT-MS-EX-d 1 EMV	160
HELU-S-RK-F-CU	408 – 409	HELUTOP® HT-PA-EX	153
HELU-S-RK-N	418	HELUTOP® HT-PA-EX-Plus	154 – 155
HELU-S-RK-S-CU-UL	407	HELUTOP® MS-E	127
HELU-S-SV-CU	419	HELUTOP® MS-EP	128
HELUTOOL 250 pocket, 190	475	HELUTOP® MS-EP4	130
HELUTOOL D20	428	HELUTOP® Protection tab	31
HELUTOOL HAM 1	437, 468	HFS	320
HELUTOOL HAP 60-2	458	HGP	304
HELUTOOL HHPI 20	457	High Strip	439
HELUTOOL HKM 1	433, 473	HSB - Boxes	313
HELUTOOL HKS 1	426	HSK	36 – 38
HELUTOOL HKS 32	429	HSK-B	41
HELUTOOL HKS 34 S	430	HSK-EX	156 – 157
HELUTOOL HKS 35	427	HSK-EX-Active	158
HELUTOOL HKS 52 S	431	HSK-INOX	144 – 145
HELUTOOL HMPI 20	456	HSK-L	39 – 40
HELUTOOL HWW 10/120	455	HSK-METRICA-P	35
HELUTOOL HWW 6/50	454	HSK-MS	77 – 78
HELUTOOL HWZ 6	448	HSK-MS-B	80
HELUTOOL MZ	464	HSK-MS-E	131
HELUTOOL PEW 8.84	443	HSK-MS-E-D	133
HELUTOOL SZ	467	HSK-MS-EX	162
HELUTOP® Easy	170	HSK-MS-EX-E	163
HELUTOP® HT	28 – 29	HSK-MS-L	79
HELUTOP® HT-AIR-MS	186	HSK-MS-PVDF	143
HELUTOP® HT-AIR-PA	185	HSK-MZ-E	132
HELUTOP® HT-BS	30	HSK-PVDF	141 – 142
HELUTOP® HT-Clean	175	HSK-WI	42
HELUTOP® HT-Clean-EMV (EMC)	176	HSSV	202 – 210, 215 – 216
HELUTOP® HT-E	140	HSSV combination	212
HELUTOP® HT-K	34	HSSV IP68	213 – 214

Glossary of Cables and Wires

Type	Page	Type	Page
HSSV-KF	180, 217	KVA-XXL-VK-MS	100
HSSV-ZE	211	KW	344
HTP	305 – 308	LI	251 – 252
IB	309	LK-I	247 – 248
IC	310	LT	269 – 274
Incision sealing ring	71	LT-CNP	280
Inside cleading cutter (universal) HIMS II	471	LT-CNP-E	281
IREV-A, FLEV-A	338	LT-E-UI	253 – 254
IREV-S	335	LT-FG-Clean	282
Jokari	434	M	239
Jokari round	436	Medium voltage accessories	339 – 340
Jokari with hook	435	MESSBOI	482
JUMBO PA12	225	MfF	328
JUMBO PA6	224	MS-Skinning-Complete-Set	474
JUMBO PUR	226	MSVM-A	337
JUMBO-FP	227	MSVM-S	333 – 334
JUMBO-WFP	228	Multistrip 10	440
K	238	NSVM-S	330 – 331
K05	451	NSVM-S E90	332
K06	452	OF	179
K25	453	O-ring	67
KAC-U	417	O-ring FKM	151
KE	234	Outside cleading cutter HAMX	469
KLL / KLÖ	357	PBE-K	187
KM	119 – 120	PV-male and female cable coupler MC4	377
KM-EMV	135	RE hexagonal	116 – 117
KM-INOX	149	RE PA-ATEX	167
KMK-PA-MB	64	RE round	118
KMK-PA-OB	65	RE-PA	62 – 63
KVA	93 – 94, 98	S	236
KVA MFDE	95 – 96	SCH	312
KVA-ASI-MS	97	SD	102
KVA-MFD-MS	90 – 91	SD, VS, HT	219
KVA-MS	88 – 89	SD-XXL	103
KVA-VK-MS	92	Sealing plug	33
KVA-XXL	101	SH, SHV	218
KVA-XXL-MS	99	Shield Kon® RSK	389
KVA-XXL-MS-E	134	SI	311

Glossary of Cables and Wires

Type	Page	Type	Page
SK	321	TY-RAP® with label	351
SK-D	323	TYZ	348
SK-M	322	UI	244
Solderless terminals	390 – 396	UNI-DICHT	48 – 50, 55, 148
SPR-AS	240	UNI-DICHT MFDE	52 – 53
SPR-EDU-AS	243	UNI-DICHT-ASI-MS	87
SPRO - rolls	317 – 319	UNI-DICHT-ASI-PA	54
SPR-PU-AS	242	UNI-DICHT-MFD-MS	83 – 84
SPR-PVC-AS	241	UNI-DICHT-MFD-PA	45 – 46
SPSP - spools	315 – 316	UNI-DICHT-MS	81 – 82
S-PU	237	UNI-DICHT-PA	43 – 44
SR	369 – 370	UNI-DICHT-VK-MS	85
ST	463	UNI-DICHT-VK-PA	47
Steel	303	UNI-DICHT-VK-PVDF	146
STK-F	58	UNI-DICHT-VK-stainless steel	147
STK-PA	56 – 57	US	249 – 250
STR	106	USH	220
Stripax-Plus	438	USK	245 – 246
STS	104	VS	121
STS-F	107	VSK-EX	168
STV	105	VSK-PA	66
SVRO	324	VS-O	122
T	352	VS-O stainless steel	150
T&B	275 – 279	W	355
TC	359 – 361	WMBW	373
TM	374	WN	59
TROMBOI 2003	479	WV	181
TROMBOI 500	476	WVF	182
TROMBOI 7-10 / TROMBOI 9-14	478	ZE	108
TROMBOI 800 / TROMBOI 1400	477	ZEI	110
TROMCAR 1000 / TROMCAR 1250	480	ZES	109
TROMTRAK 1250	481		
T-SK/SKU	353		
T-WS	354		
TYH	347		
TY-MX	346		
TY-RAP®	345, 349		
TY-RAP® special cable tie	350		

Part No. Index

Part no.	Page	Part no.	Page	Part no.	Page
90000 – 90029	37	90402 – 90403	227	90865	116
90030 – 90039	157	90404 – 90405	228	90870 – 90878	64
90040 – 90049	40	90406 – 90407	227, 228	90890 – 90897	68
90054	231	90408 – 90409	224	90900 – 90907	356
90055 – 90057	390	90423 – 90432	131	90909	116
90058	317	90433 – 90439	192	90910 – 90935	407
90061 – 90066	230	90440 – 90447	195	91000 – 91003	344
90067	119	90448 – 90455	192	91006 – 91013	269
90068	134	90456 – 90463	195	91014 – 91021	271
90069 – 90075	63	90464 – 90473	237	91022 – 91029	273
90076 – 90084	61	90480 – 90488	202	91030 – 91031	387
90090 – 90097	105	90489	119	91036	361
90100 – 90105	107	90490 – 90498	202	91039 – 91048	359
90116 – 90120	59	90530 – 90539	106	91050 – 91051	345
90125 – 90128	385	90540 – 90549	104	91052	346
90140 – 90159	352	90550 – 90558	105	91054 – 91055	345
90160 – 90161	133	90559 – 90568	56	91056	346
90162 – 90163	132	90569 – 90578	109	91057 – 91058	345
90165 – 90172	135	90586 – 90601	102	91059	346
90175 – 90182	119	90604 – 90609	103	91060 – 91061	345
90186 – 90199	120	90610 – 90619	119	91062	346
90200 – 90209	162	90620 – 90629	121	91063 – 91064	345
90210 – 90219	145	90630 – 90641	115	91065	346
90263 – 90270	67	90664 – 90673	246	91066 – 91067	345
90271 – 90273	179	90684 – 90692	275	91068	346
90275 – 90284	109	90693 – 90700	277	91069 – 91070	345
90291	94	90701 – 90708	278	91071	346
90292 – 90298	77	90710 – 90719	64	91072 – 91073	345
90299	94	90720 – 90729	248	91074	346
90300 – 90309	78	90730 – 90738	252	91075 – 91076	345
90310 – 90319	79	90750 – 90759	75	91077	346
90320 – 90331	41	90760 – 90767	74	91078 – 91079	345
90354 – 90376	89	90770 – 90779	127	91080	346
90377 – 90378	145	90788 – 90796	92	91081 – 91082	345
90383 – 90388	179	90800 – 90809	88	91083	346
90390 – 90394	89	90810	276	91084 – 91085	345
90397 – 90398	131	90811 – 90828	88	91086	346
90399	242	90829 – 90835	47	91087 – 91088	345

Part No. Index

Part no.	Page	Part no.	Page	Part no.	Page
91089	346	91431 – 91435	394	91912 – 91922	382
91090 – 91092	358	91436	395	91923	438
91093 – 91103	350	91437 – 91440	394	91924	441
91106 – 91114	351	91441	395	91974	89
91131	242	91442 – 91445	394	92039 – 92079	91
91146 – 91147	374	91447 – 91456	168	92093	89
91148 – 91155	372	91475 – 91492	390	92094 – 92099	91
91158 – 91162	373	91514 – 91546	397	9210x – 92294	310
91163	446	91547 – 91555	398	92300 – 92308	41
91165 – 91166	324	91556 – 91560	399	9231x – 9232x	316
91180 – 91181	374	91589 – 91598	384	92335	315
91200 – 91204	220	91600	134	9233x	316
91209 – 91217	238	91601 – 91603	444	92345	315
91219 – 91228	236	91607	449	9234x	316
91229 – 91237	258	91610 – 91611	450	92355	315
91238 – 91244	261	91612	445	9235x	316
91245 – 91251	259	91616 – 91618	449	92365	315
91259 – 91265	265	91621	192	9236x	316
91270 – 91279	236	91622 – 91629	385	92375	315
91280 – 91283	389	91630 – 91650	38	9237x	316
91284 – 91287	42	91651 – 91673	385	92385	315
91290 – 91299	314	91675 – 91678	142	9238x	316
91300 – 91309	312	91680 – 91689	40	92395	315
91310 – 91320	309	91690 – 91691	39	9239x	316
91321 – 91330	313	91692 – 91697	40	92405	315
91331 – 91340	314	91700 – 91701	39	9240x	316
91350 – 91351	380	91702 – 91717	40	9241x – 9251x	318
91352 – 91359	381	91720 – 91727	79	92600 – 92607	122
91362 – 91363	224	91730 – 91735	182	92610 – 92636	38
91367	92	91777 – 91786	315	92640 – 92666	157
91368 – 91376	387	91788 – 91799	317	92667 – 92669	28
91377 – 91381	399	91816 – 91833	37	92675	195
91383 – 91384	380	91835 – 91837	179	92676 – 92687	194
91385 – 91397	381	91840 – 91843	42	92690 – 92704	42
91398	393	91845 – 91848	78	92713 – 92724	194
91403 – 91421	391	91849	390	92779	99
91422 – 91425	392	91850 – 91870	380	92780 – 92804	29
91426 – 91430	393	91871 – 91911	381	92819 – 92829	56

Part No. Index

Part no.	Page	Part no.	Page	Part no.	Page
92870 – 92887	163	93440 – 93443	103	94066	115
92888	117	93450 – 93458	246	94067 – 94068	118
92890 – 92892	163	93460 – 93467	245	94069	115
92900 – 92903	162	93470 – 93478	248	94070	118
92905 – 92907	131	93480 – 93487	247	94072	115
92908 – 92910	132	93497 – 93508	220	94073	116
92911 – 92925	80	93514 – 93518	232	94074	118
92930 – 92938	182	93520 – 93528	250	94075	115
92970 – 92977	149	93529	475	94076	116
93000 – 93001	361	93530 – 93537	249	94077	118
93003 – 93005	360	93539	79	94078	115
93006	359	93560 – 93568	250	94079 – 94080	118
93007	360	93569	99	94081	115
93030	380	93570 – 93577	249	94082 – 94083	118
93031 – 93034	381	93580 – 93588	250	94098 – 94102	114
93036 – 93043	382	93590 – 93597	249	94120 – 94127	59
93044 – 93045	360	93600 – 93608	252	94151 – 94156	269
93046 – 93048	382	93610 – 93617	251	94160 – 94163	271
93096 – 93099	387	93630 – 93644	305	94166 – 94169	112
93105	99	93645	307	94170 – 94173	273
93107 – 93124	333	93650 – 93682	60	94174 – 94178	112
93125 – 93127	339	93690 – 93693	324	94180 – 94186	202
93128 – 93133	340	93694 – 93699	346	94188 – 94189	134
93135 – 93140	334	93715 – 93725	183	94190 – 94196	202
93141	339	93727	99	94200 – 94206	204
93142 – 93145	334	93728	134	94208	134
93147 – 93150	329	93730 – 93737	357	94210 – 94216	204
93186 – 93188	334	93740 – 93765	396	94218	134
93190 – 93203	335	93781 – 93789	192	94220 – 94235	209
93209	135	93790 – 93799	195	94240 – 94247	110
93263 – 93275	420	93850 – 93882	34	94250 – 94267	64
93360 – 93373	336	93890 – 93894	330	94270 – 94299	65
93379	333	93908 – 93944	28	94330 – 94338	328
93380	336	94000 – 94022	387	94350 – 94359	337
93382 – 93389	331	94023	380	94371 – 94394	338
93398	333	94024	381	94400 – 94408	331
93400 – 93426	90	94064	115	94420 – 94425	335
93427 – 93438	91	94065	118	94426 – 94430	336

Part No. Index

Part no.	Page	Part no.	Page	Part no.	Page
94435 – 94439	335	95697	369	96376 – 96384	70
94443 – 94447	336	956xx	370	96387 – 96393	94
94460 – 94476	332	95797	369	96397	91
94484 – 94489	107	957xx – 959xx	370	96400 – 96402	390
94530 – 94557	30	96003 – 96004	40	96403	37
94559	79	96005 – 96031	94	96404 – 96405	40
94624	74	96032	101	96406	42
94630 – 94657	65	96033 – 96042	92	96410	262
94663 – 94670	218	96043 – 96049	47	96415	394
94671 – 94679	219	96050 – 96075	95	96416 – 96425	69
94700 – 94707	66	96076 – 96097	96	96428	394
94714	242	96102	179	96430 – 96434	91
94721 – 94724	306	96103	42	96436 – 96438	95
94735	262	96104 – 96108	37	96439 – 96441	96
94738 – 94739	242	96110 – 96122	157	96443	95
94741 – 94747	311	96149	89	96445	96
94750 – 94757	66	96169 – 96171	122	96447 – 96451	255
94758	306	96176 – 96177	64	96455 – 96456	37
94781 – 94782	179	96179 – 96185	66	96458 – 96464	64
94800	348	96186 – 96195	63	96465	276
94847	134	96205 – 96207	276	96481	347
94860 – 94869	71	96208 – 96211	277	96485	95
94870 – 94879	237	96212 – 96215	279	96491 – 96492	352
94880 – 94888	240	96225 – 96226	157	96526	89
94890 – 94898	241	96228	64	96527	66
94900 – 94912	304	96230 – 96238	96	96529 – 96538	68
94915 – 94918	258	96247	262	96544	37
94920 – 94928	243	96248 – 96252	258	96560	134
94929	395	96253 – 96256	40	96561	303
94930 – 94933	258	96277	313	96564	91
94934 – 94942	241	96290	348	96574	395
94944	390	96291	347	96575 – 96576	391
94946 – 94947	116	96299 – 96300	344	96577	347
94970 – 94987	66	96328 – 96335	395	96580	283
94988 – 94993	263	96336	91	96581 – 96584	42
94994 – 94999	264	96342 – 96347	255	96593	66
95099	61	96357 – 96365	71	96594 – 96595	392
950xx – 955xx	370	96366 – 96375	67	96597 – 96602	157

Part No. Index

Part no.	Page	Part no.	Page	Part no.	Page
96604	383	96793	168	97107	313
96607 – 96616	390	96795	309	97110	179
96617	386	96796	324	97119 – 97120	89
96618	61	96803	283	97134 – 97135	231
96620	390	96805	156	97148 – 97152	463
96621	95	96806	195	97153	258
96629	386	96828	317	97154	347
96638	96	96830	313	97156	156
96648	386	96839	283	97162	309
96649 – 96650	122	96841	387	97166 – 97171	135
96652	386	96880	283	97175	258
96654	122	96881	91	97184 – 97192	142
96658 – 96659	344	96883	37	97197 – 97202	303
96662	151	96889	122	97203	311
96671	383	96891	344	97205	231
96678	78	96909	348	97213	347
96687	313	96912	37	97219 – 97223	352
96688	383	96915	70	97228	309
96710	91	96926	96	97243 – 97246	135
96714	96	96929	317	97249 – 97250	347
96718	258	96939	258	97277	95
96723	95	96954	262	97280	347
96724	348	96956	91	97281 – 97283	309
96727	383	96960 – 96961	66	97289	96
96732	231	96967 – 96973	36	97300	279
96736	383	96974 – 96980	37	97306	37
96737	276	96981 – 96986	42	97310 – 97314	346
96739	277	96997 – 97006	66	97315 – 97317	64
96748	142	97007 – 97013	63	97327	91
96749	383	97014 – 97022	239	97335 – 97340	131
96751 – 96752	313	97023 – 97031	240	97343	447
96753	383	97032 – 97040	241	97356	463
96757	461	97042	344	97377 – 97379	243
96761	313	97066	134	97382	204
96763	122	97073	179	97385	324
96764	383	97085	313	97388	442
96776	390	97087 – 97095	93	97389	98
96784	243	97103	78	97390	97

Part No. Index

Part no.	Page	Part no.	Page	Part no.	Page
97396	98	97696	390	98088 – 98097	106
97397 – 97403	302	97702 – 97709	241	98098 – 98107	104
97408	97	97752	133	98108 – 98113	102
97417	463	97753	151	98114 – 98119	168
97418 – 97419	40	97757	311	98128 – 98135	121
97426 – 97427	311	97763	168	98136 – 98148	304
97436 – 97437	346	97765 – 97766	397	98149 – 98155	260
97445 – 97447	143	97767	40	98163 – 98170	64
97448	96	97774	324	98171 – 98179	275
97472 – 97473	95	97775	482	98180 – 98184	277
97479	384	97782 – 97784	325	98185 – 98189	278
97480	283	97785	120	98190 – 98192	276
97485	313	97788	133	98196 – 98197	277
97496	231	97793 – 97794	242	98201	132
97500	143	97802 – 97803	37	98202 – 98205	37
97502	179	97805 – 97809	418	98206 – 98232	250
97510	243	97811	262	98233 – 98256	249
97512 – 97513	95	97812	325	98257	134
97527 – 97531	141	97816 – 97823	64	98258 – 98263	321
97535 – 97546	463	97829 – 97849	62	98264 – 98266	325
97550 – 97558	36	97853	96	98267 – 98284	418
97559 – 97564	156	97873	37	98285	77
97565 – 97576	143	97924	482	98286 – 98289	145
97580	256	97941	242	98290	37
97584 – 97587	243	97944	204	98291	279
97594 – 97601	245	97945	262	98303	435
97602 – 97609	247	97956 – 97961	36	98314	119
97619 – 97626	251	97962 – 97964	156	98322 – 98330	250
97633 – 97636	355	97965 – 97966	37	98331 – 98338	249
97642 – 97654	325	97967 – 97976	36	98363	204
97655 – 97660	133	97977 – 97985	37	98364	283
97661 – 97662	78	97986 – 98004	156	98366	64
97663 – 97664	143	98005 – 98016	41	98435 – 98447	204
97668	262	98033 – 98044	77	98448	439
97671	279	98045 – 98054	162	98519	313
97680 – 97684	256	98055 – 98060	133	98520 – 98522	347
97685	241	98061 – 98075	132	98561 – 98564	181
97691 – 97694	256	98076 – 98087	144	98577 – 98584	394

Part No. Index

Part no.	Page	Part no.	Page	Part no.	Page
98585 – 98589	61	900015 – 900016	171	904282 – 904294	151
98594 – 98596	151	901006	234	904295	43
98598 – 98599	394	903035 – 903098	319	904296 – 904312	111
98698	135	903120 – 903149	171	904313 – 904342	112
98700 – 98701	394	903459 – 903470	211	904343 – 904359	113
98716 – 98717	436	903492 – 903496	31	904360 – 904379	114
98718 – 98721	434	903502 – 903526	33	904380 – 904386	116
98725	134	903527	79	904387 – 904406	117
98726 – 98729	463	903529 – 903531	32	904407 – 904420	118
98744 – 98745	215	903532 – 903559	28	904421 – 904427	166
98908	134	903560 – 903567	74	904428 – 904448	167
98983	204	903624	443	904449 – 904465	164
99020 – 99025	181	903685	462	904466 – 904489	165
99049 – 99058	108	903716	475	904492 – 904495	187
99208 – 99217	78	903718 – 903735	462	904686 – 904687	97
99270 – 99277	218	903796 – 903799	54	904692 – 904693	462
99278 – 99286	219	903800 – 903825	43	904731	440
99300 – 99329	29	903826 – 903855	44	904734	451
99434 – 99439	101	903856 – 903882	45	904735	452
99510 – 99518	256	903883 – 903940	46	904760 – 904761	476
99520 – 99547	35	903941	47	904762 – 904763	477
99551 – 99563	320	903942 – 903951	48	904764 – 904765	478
99610 – 99628	193	903952 – 903970	49	904766	479
99630 – 99634	141	903971 – 903991	50	904767 – 904768	480
99678 – 99799	322	903992 – 903993	55	904769	481
99800 – 99803	140	903994 – 904017	52	904771	317
99804 – 99806	34	904018 – 904060	53	904774 – 904780	462
99808 – 99811	127	904061 – 904087	81	904787	466
99821 – 99822	369	904088 – 904120	82	904797 – 904804	199
99841 – 99856	39	904121 – 904124	87	904805 – 904819	200
99857 – 99864	40	904125 – 904151	83	904820 – 904834	199
99875	135	904152 – 904209	84	904835 – 904849	200
99891 – 99896	215	904210 – 904230	85	904861 – 904867	199
99901 – 99907	34	904231 – 904239	57	904892 – 904893	464
99950 – 99957	128	904240 – 904246	146	904907 – 904913	280
99960 – 99963	74	904247 – 904253	147	904924	305
99965 – 99968	75	904254 – 904277	148	904926	32
99970 – 99987	140	904278 – 904281	171	904933	428

Part No. Index

Part no.	Page	Part no.	Page	Part no.	Page
904963 – 904964	377	905796	197	906436	414
904996 – 904998	58	905804 – 905811	244	906455	467
905024	83	905812 – 905831	253	906459	414
905027 – 905030	283	905832 – 905847	254	906460	422
905031 – 905042	232	905849	465	906461 – 906477	414
905058 – 905063	281	905858 – 905859	202	906478 – 906485	415
905067 – 905068	58	905863 – 905864	377	906486 – 906494	416
905084	143	905870 – 905875	119	906495 – 906508	422
905116 – 905119	137	905877 – 905883	108	906509 – 906510	423
905120	136, 432	905891 – 905897	483	906511 – 906521	421
905122	137	905898 – 905908	484	906524 – 906531	412
905163	483	905909	485	906532 – 906538	413
905179 – 905180	309	905910 – 905911	55	906682 – 906686	354
905181 – 905189	130	905912	242	906691 – 906700	153
905206 – 905211	377	905913 – 905914	281	906843 – 906846	282
905248	130	905918 – 905919	485	906914 – 906917	175
905303	134	905924 – 905929	31	906918 – 906920	176
905332	173	905946 – 905953	150	906921 – 906924	175, 176
905335 – 905344	323	905957 – 905966	99	906928 – 906929	282
905371 – 905376	483	905989 – 905996	249	906938 – 906940	153
905439 – 905441	308	905997 – 906005	250	906941 – 906958	159
905498	134	906006 – 906014	256	906959 – 906964	160
905506	103	906049 – 906053	417	906965 – 906981	161
905525 – 905546	354	906172 – 906173	415	906982	159
905555 – 905559	308	906174 – 906175	416	906990 – 906992	185
905561	453	906185	415	906993 – 906996	186
905570 – 905578	103	906199	74	907016 – 907038	353
905597 – 905607	485	906209	422	907275 – 907277	28
905663	465	906210	423	907303 – 907317	400
905720 – 905723	177	906212	416	907318 – 907347	401
905724 – 905727	178	906233	437, 468	907348 – 907407	402
905731 – 905732	323	906235	469	907409 – 907434	408
905733 – 905736	144	906237	470	907435 – 907461	409
905737 – 905748	145	906240	471	907467 – 907499	403
905749 – 905755	270	906242	472	907500 – 907507	404
905756 – 905762	272	906244	474	907508 – 907543	405
905763 – 905769	274	906245	433, 473	907544 – 907567	406
905773 – 905791	32	906406	421	907568 – 907593	415

Part No. Index

Part no.	Page	Part no.	Page	Part no.	Page
907594 – 907596	416	907728	413	920179	230
907597 – 907601	403	907729 – 907730	410	920180	231
907602	427	907731	413	920183 – 920186	202
907603	429	907732 – 907739	410	920190 – 920192	204
907605	431	907740 – 907743	411	920196 – 920208	203
907611	448	907744	413	920209 – 920218	205
907612	454	907745 – 907746	411	920220 – 920228	209
907613	455	907747	413	920229 – 920245	206
907614	456	907748	411	920247 – 920264	208
907615 – 907622	459	907749	413	920265 – 920272	207
907677 – 907678	412	907811 – 907830	419	920273 – 920288	210
907679	410	907835	421	920289 – 920298	212
907680 – 907681	412	907836 – 907859	422	920307 – 920322	216
907682 – 907684	410	907860 – 907862	423	920323 – 920334	218
907685 – 907687	412	907865 – 907884	414	920357 – 920361	233
907688	410	908053	430	920368 – 920369	227
907689 – 907692	412	908054 – 908063	170	920372 – 920373	228
907693 – 907694	410	908080 – 908104	154	920375	233
907695 – 907697	412	908105 – 908129	155	920378 – 920381	225
907698 – 907700	410	908211 – 908217	266	920382 – 920383	226
907701 – 907703	412	908229	426	920384 – 920403	196
907704	410	908230 – 908234	459	920404 – 920421	213
907705	412	908273 – 908285	460	920422 – 920439	214
907706	410	908286	457	920507 – 920518	180, 217
907707 – 907709	412	908368 – 908387	170	920522	269
907710	410	908421 – 908423	109	920523 – 920525	273
907711	412	908468	154	920526 – 920528	271
907712 – 907714	410	908469	155	920605 – 920612	149
907715 – 907716	412	908473 – 908480	267	980000	172
907717 – 907718	410	908481 – 908488	268	980010 – 980016	174
907719 – 907720	412	908494	458		
907721	410	908524 – 908532	349		
907722	412	908540 – 908559	158		
907723	410	920102 – 920129	32		
907724	412	920144 – 920146	100		
907725	410	920154 – 920155	194		
907726	412	920156 – 920168	197		
907727	410	920170 – 920178	198		

NOTES

Prices

Prices are valid from 01. April 2016. Errors excepted. All prices are subject to change and without obligation

Technical modifications

© HELUKABEL® GmbH Hemmingen

Dimensions and specifications may change without prior notice. Consequently all illustrations, numerical data, etc. are provided without guarantee. Colour deviations between photos and delivered goods cannot be avoided. Reproduction or duplication of the text and illustrations, in whole or in part, remain reserved. The transfer of copyrights always requires the written consent of HELUKABEL® GmbH. Our General Terms of Delivery and Payment, which can be viewed at www.helukabel.com, apply.

Length markings

The length marking, which cannot be calibrated, is an aid, e.g. for easy material allowance determination or for determination of the length remaining on the drum. Deviation of the line length shown by the marking is up to 1%. Incomplete length markings or length markings missing on sections, deviations of the cable length shown by the length marking do not substantiate any legal obligation whatsoever. Only use calibrated measurement devices to determine line length.

Safety notice

The cables and wires described in the catalog are produced in accordance with national and international standards, as well as plant standards; application safety, as stipulated in the safety directives, standards, and statutory regulations, as amended, is provided. Following proper installation and usage guidelines, the possibility of product-specific dangers can be excluded. For each product this catalog describes general information for use. Independent of the above, the applicable DIN VDE specifications apply. Installation and processing must only be executed by qualified electricians.

VDE approval

„Extracts from DIN standards with VDE classification are reproduced for the registered limited press run via permit no. 392.013, issued by Deutsches Institut für Normung e.V. [German Institute for Standardization] and VDE Verband der Elektrotechnik Elektronik Informationstechnik e.V. [Institute of Electrical and Electronics Engineers]. Any further reproduction or printing of these materials is subject to a specific permit. The versions of the standards with the most recent issue data are binding for the application thereof. These versions can be obtained from VDE VERLAG GMBH, Bismarckstr. 33, 10625 Berlin, www.vde-verlag.de.“

Our General Terms of Delivery and Payment, which can be viewed at www.helukabel.com, apply

