

NLSF3T126

Quad Bus Buffer with 3-State Control Inputs

The NLSF3T126 is a high speed CMOS quad bus buffer fabricated with silicon gate CMOS technology. It achieves noninverting high speed operation similar to equivalent Bipolar Schottky TTL while maintaining CMOS low power dissipation.

The NLSF3T126 requires the 3-state control input (OE) to be set Low to place the output into high impedance.

The T126 inputs are compatible with TTL levels. This device can be used as a level converter for interfacing 3.3 V to 5.0 V, because it has full 5.0 V CMOS level output swings.

The NLSF3T126 input structures provide protection when voltages between 0 V and 5.5 V are applied, regardless of the supply voltage. The output structures also provide protection when $V_{CC} = 0$ V. These input and output structures help prevent device destruction caused by supply voltage – input/output voltage mismatch, battery backup, hot insertion, etc.

The internal circuit is composed of three stages, including a buffer output which provides high noise immunity and stable output. The inputs tolerate voltages up to 7.0 V, allowing the interface of 5.0 V systems to 3.0 V systems.

Features

- High Speed: $t_{PD} = 3.8$ ns (Typ) at $V_{CC} = 5.0$ V
- Low Power Dissipation: $I_{CC} = 4.0$ μ A (Max) at $T_A = 25^\circ$ C
- TTL-Compatible Inputs: $V_{IL} = 0.8$ V; $V_{IH} = 2.0$ V
- Power Down Protection Provided on Inputs
- Balanced Propagation Delays
- Designed for 2.0 V to 5.5 V Operating Range
- Low Noise: $V_{OLP} = 0.8$ V (Max)
- Pin and Function Compatible with Other Standard Logic Families
- Latchup Performance Exceeds 300 mA
- ESD Performance: Human Body Model; > 2000 V, Machine Model > 200 V
- Chip Complexity: 72 FETs or 18 Equivalent Gates
- Pb-Free Package is Available*

FUNCTION TABLE

Inputs		Output
A	OE	Y
L	H	L
H	H	H
X	L	Z

*For additional information on our Pb-Free strategy and soldering details, please download the ON Semiconductor Soldering and Mounting Techniques Reference Manual, SOLDERRM/D.



ON Semiconductor®

<http://onsemi.com>



QFN-16
CASE 485G

MARKING DIAGRAM

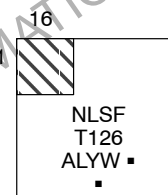

NLSFT126 = Device Code
 A = Assembly Location
 L = Wafer Lot
 Y = Year
 W = Work Week
 ■ = Pb-Free Package
 (Note: Microdot may be in either location)

ORDERING INFORMATION

Device	Package	Shipping†
NLSF3T126MNR2	QFN-16	3000/Tape & Reel
NLSF3T126MNR2G	QFN-16 (Pb-Free)	3000/Tape & Reel

†For information on tape and reel specifications, including part orientation and tape sizes, please refer to our Tape and Reel Packaging Specifications Brochure, BRD8011/D.

NLSF3T126

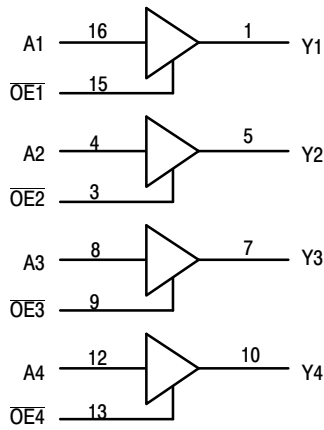

**Figure 1. Logic Diagram
Active-High Output Enables**

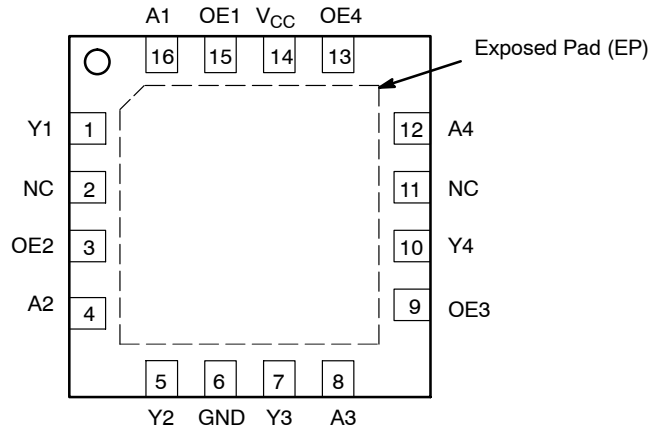

Figure 2. QFN – 16 Pinout (Top View)

MAXIMUM RATINGS

Rating	Symbol	Value	Unit
DC Supply Voltage	V_{CC}	-0.5 to +7.0	V
DC Input Voltage	V_{in}	-0.5 to +7.0	V
DC Output Voltage	V_{out}	-0.5 to +7.0 -0.5 to $V_{CC} + 0.5$	V
Input Diode Current	I_{IK}	-20	mA
Output Diode Current ($V_{OUT} < GND$; $V_{OUT} > V_{CC}$)	I_{OK}	± 20	mA
DC Output Current, per Pin	I_{out}	± 25	mA
DC Supply Current, V_{CC} and GND Pins	I_{CC}	± 75	mA
Power Dissipation in Still Air, QFN Packages	P_D	500	mW
Storage Temperature	T_{stg}	-65 to +150	$^{\circ}C$

Stresses exceeding Maximum Ratings may damage the device. Maximum Ratings are stress ratings only. Functional operation above the Recommended Operating Conditions is not implied. Extended exposure to stresses above the Recommended Operating Conditions may affect device reliability.

RECOMMENDED OPERATING CONDITIONS

Parameter	Symbol	Min	Max	Unit
DC Supply Voltage	V_{CC}	2.0	5.5	V
DC Input Voltage	V_{in}	0	5.5	V
DC Output Voltage	V_{out}	0	5.5 V_{CC}	V
Operating Temperature	T_A	-40	+85	$^{\circ}C$
Input Rise and Fall Time	t_r, t_f	0	20	ns/V

This device contains protection circuitry to guard against damage due to high static voltages or electric fields. However, precautions must be taken to avoid applications of any voltage higher than maximum rated voltages to this high-impedance circuit. For proper operation, V_{in} and V_{out} should be constrained to the range $GND \leq (V_{in} \text{ or } V_{out}) \leq V_{CC}$. Unused inputs must always be tied to an appropriate logic voltage level (e.g., either GND or V_{CC}). Unused outputs must be left open.

NLSF3T126

DC ELECTRICAL CHARACTERISTICS

Parameter	Test Conditions	Symbol	V _{CC} (V)	T _A = 25°C			T _A ≤ 85°C		T _A ≤ 125°C		Unit
				Min	Typ	Max	Min	Max	Min	Max	
Minimum High-Level Input Voltage	2.3 V ± 0.3 V 3.3 V ± 0.3 V 5.0 V ± 0.5 V	V _{IH}		0.5 V _{CC} 0.4 V _{CC} 0.44 V _{CC}			0.5 V _{CC} 0.4 V _{CC} 0.44 V _{CC}		0.5 V _{CC} 0.4 V _{CC} 0.44 V _{CC}		V
Maximum Low-Level Input Voltage	2.3 V ± 0.3 V 3.3 V ± 0.3 V 5.0 V ± 0.5 V	V _{IL}				0.3 V _{CC} 0.18 V _{CC} 0.18 V _{CC}		0.3 V _{CC} 0.18 V _{CC} 0.18 V _{CC}		0.3 V _{CC} 0.18 V _{CC} 0.18 V _{CC}	V
Minimum High-Level Output Voltage V _{IN} = V _{IH} or V _{IL}	V _{OL} @ I _{OL} , 50 mA V _{IN} = V _{IH} or V _{IL} I _{OH} = -50 μA	V _{OH}	2.0 3.0 4.5	1.9 2.9 4.4	2.0 3.0 4.5		1.9 2.9 4.4		1.9 2.9 4.4		V
	V _{IN} = V _{IH} or V _{IL} I _{OH} = -2.0 mA I _{OH} = -4.0 mA I _{OH} = -8.0 mA		2.0 3.0 4.5	1.82 2.58 3.94			1.72 2.48 3.80		1.60 2.34 3.66		
Maximum Low-Level Output Voltage V _{IN} = V _{IH} or V _{IL}	V _{OL} @ I _{OL} , 50 mA V _{IN} = V _{IH} or V _{IL} I _{OL} = 50 μA	V _{OL}	2.0 3.0 4.5		0.0 0.0 0.0	0.1 0.1 0.1		0.1 0.1 0.1		0.1 0.1 0.1	V
	V _{IN} = V _{IH} or V _{IL} I _{OL} = 2.0 mA I _{OL} = 4.0 mA I _{OL} = 8.0 mA		2.0 3.0 4.5			0.36 0.36 0.36		0.44 0.44 0.44		0.52 0.52 0.52	
Maximum Input Leakage Current	V _{IN} = 5.5 V or GND	I _{IN}	0 to 5.5			±0.1		±1.0		±1.0	μA
Maximum Quiescent Supply Current	V _{IN} = V _{CC} or GND	I _{CC}	5.5			2.0		20		40	μA
Quiescent Supply Current	Input: V _{IN} = 3.4 V	I _{CC} T	5.5			1.35		1.50		1.65	mA
Maximum 3-State Leakage Current	V _{IN} = V _{IH} or V _{IL} V _{OUT} = V _{CC} or GND	I _{OZ}	5.5			±0.25		±2.5		±2.5	μA
Output Leakage Current	V _{OUT} = 5.5 V	I _{OPD}	0.0			0.5		5.0		10	μA

THIS DEVICE IS NOT A REPRESENTATIVE

NLSF3T126

AC ELECTRICAL CHARACTERISTICS (Input $t_r = t_f = 3.0$ ns)

Parameter	Test Conditions	Symbol	$T_A = 25^\circ\text{C}$			$T_A = \leq 85^\circ\text{C}$		$T_A \leq 125^\circ\text{C}$		Unit
			Min	Typ	Max	Min	Max	Min	Max	
Maximum Propagation Delay, A to Y	$V_{CC} = 2.3 \pm 0.3$ V $C_L = 15$ pF	t_{PLH} , t_{PHL}	1.0	14.5	16.9	1.0	18.1	1.0	19.2	ns
	$V_{CC} = 3.3 \pm 0.3$ V $C_L = 15$ pF $C_L = 50$ pF		1.0 1.0	5.6 8.1	8.0 11.5	1.0 1.0	9.5 13.0	1.0 1.0	12.0 16.0	ns
	$V_{CC} = 5.0 \pm 0.5$ V $C_L = 15$ pF $C_L = 50$ pF		1.0 1.0	3.8 5.3	5.5 7.5	1.0 1.0	6.5 8.5	1.0 1.0	8.5 10.5	ns
Maximum Output Enable Time, OE to Y	$V_{CC} = 2.3 \pm 0.3$ V $C_L = 15$ pF	t_{PZL} , t_{PZH}	1.0	14.8	16.2	1.0	17.4	1.0	19.3	ns
	$V_{CC} = 3.3 \pm 0.3$ V $C_L = 15$ pF $R_L = 1.0$ k Ω $C_L = 50$ pF		1.0 1.0	5.4 7.9	8.0 11.5	1.0 1.0	9.5 13.0	1.0 1.0	11.5 15.0	ns
	$V_{CC} = 5.0 \pm 0.5$ V $C_L = 15$ pF $R_L = 1.0$ k Ω $C_L = 50$ pF		1.0 1.0	3.6 5.1	5.1 7.1	1.0 1.0	6.0 8.0	1.0 1.0	7.5 9.5	ns
Maximum Output Disable Time, OE to Y	$V_{CC} = 2.3 \pm 0.3$ V $C_L = 15$ pF	t_{PLZ} , t_{PHZ}	1.0	15.4	18.0	1.0	19.8	1.0	22.0	ns
	$V_{CC} = 3.3 \pm 0.3$ V $C_L = 50$ pF $R_L = 1.0$ k Ω		1.0	9.5	13.2	1.0	15.0	1.0	18.0	ns
	$V_{CC} = 5.0 \pm 0.5$ V $C_L = 50$ pF $R_L = 1.0$ k Ω		1.0	6.1	8.8	1.0	10.0	1.0	12.0	ns
Output-to-Output Skew	$V_{CC} = 3.3 \pm 0.3$ V $C_L = 50$ pF (Note 1)	t_{OSLH} , t_{OSHL}			1.5		1.5		2.0	ns
	$V_{CC} = 5.0 \pm 0.5$ V $C_L = 50$ pF (Note 1)				1.0		1.0		1.5	ns
Maximum Input Capacitance		C_{in}		4.0	10		10		10	pF
Maximum 3-State Output Capacitance (Output in High Impedance State)		C_{out}		6.0						pF
Power Dissipation Capacitance (Note 2)		C_{PD}	Typical @ 25°C , $V_{CC} = 5.0$ V						pF	
			15							

1. Parameter guaranteed by design. $t_{OSLH} = |t_{PLHm} - t_{PLHn}|$, $t_{OSHL} = |t_{PHLm} - t_{PHLn}|$.

2. C_{PD} is defined as the value of the internal equivalent capacitance which is calculated from the operating current consumption without load. Average operating current can be obtained by the equation: $I_{CC(OPR)} = C_{PD} \cdot V_{CC} \cdot f_{in} + I_{CC}/4$ (per buffer). C_{PD} is used to determine the no-load dynamic power consumption; $P_D = C_{PD} \cdot V_{CC}^2 \cdot f_{in} + I_{CC} \cdot V_{CC}$.

NOISE CHARACTERISTICS (Input $t_r = t_f = 3.0$ ns, $C_L = 50$ pF, $V_{CC} = 5.0$ V)

Characteristic	Symbol	$T_A = 25^\circ\text{C}$		Unit
		Typ	Max	
Quiet Output Maximum Dynamic V_{OL}	V_{OLP}	0.3	0.8	V
Quiet Output Minimum Dynamic V_{OL}	V_{OLV}	-0.3	-0.8	V
Minimum High Level Dynamic Input Voltage	V_{IHD}		3.5	V
Maximum Low Level Dynamic Input Voltage	V_{ILD}		1.5	V

SWITCHING WAVEFORMS

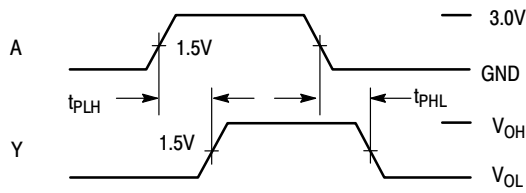

Figure 3.

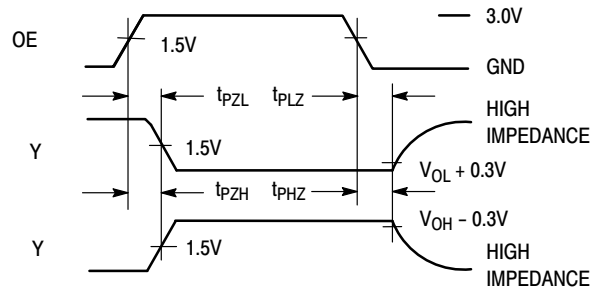
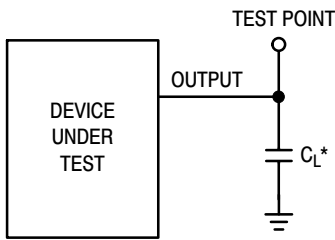
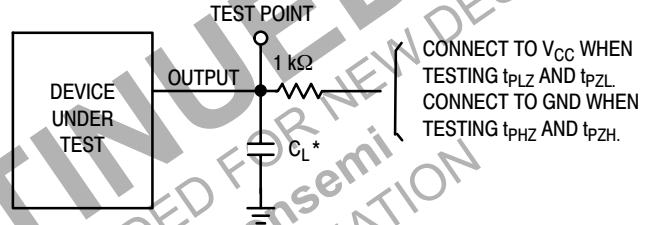

Figure 4.



*Includes all probe and jig capacitance

Figure 5. Test Circuit



*Includes all probe and jig capacitance

Figure 6. Test Circuit

DISCONTINUED

THIS DEVICE IS NOT RECOMMENDED FOR NEW DESIGN
PLEASE CONTACT YOUR onsemi REPRESENTATIVE FOR INFORMATION

MECHANICAL CASE OUTLINE PACKAGE DIMENSIONS



SCALE 2:1

QFN16 3x3, 0.5P
CASE 485G
ISSUE G

DATE 08 OCT 2021

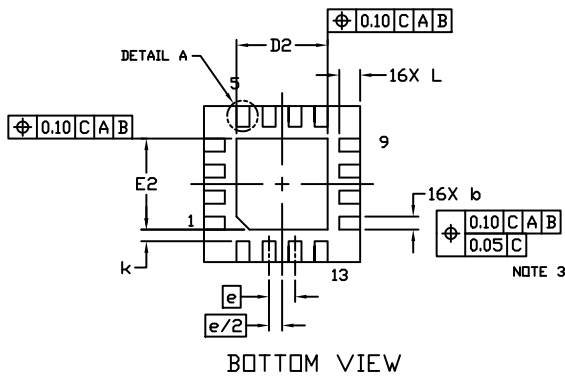
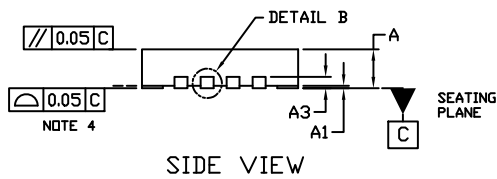
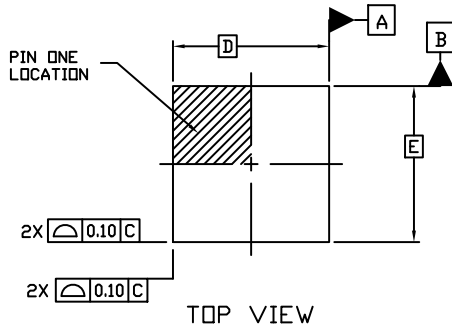

NOTES:

1. DIMENSIONING AND TOLERANCING PER ASME Y14.5M, 1994.
2. CONTROLLING DIMENSION: MILLIMETERS
3. DIMENSION *b* APPLIES TO PLATED TERMINAL AND IS MEASURED BETWEEN 0.15 AND 0.30 MM FROM THE TERMINAL TIP.
4. COPLANARITY APPLIES TO THE EXPOSED PAD AS WELL AS THE TERMINALS.

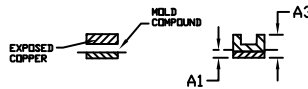

DETAIL B
ALTERNATE
CONSTRUCTIONS

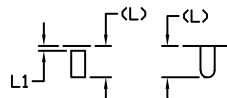

DETAIL A
ALTERNATE TERMINAL
CONSTRUCTIONS

DIM	MILLIMETERS		
	MIN.	NDM.	MAX.
A	0.80	0.90	1.00
A1	0.00	0.03	0.05
A3	0.20 REF		
<i>b</i>	0.18	0.24	0.30
D	3.00 BSC		
D2	1.65	1.75	1.85
E	3.00 BSC		
E2	1.65	1.75	1.85
<i>e</i>	0.50 BSC		
<i>k</i>	0.18 TYP		
L	0.30	0.40	0.50
L1	0.00	0.08	0.15

MOUNTING FOOTPRINT

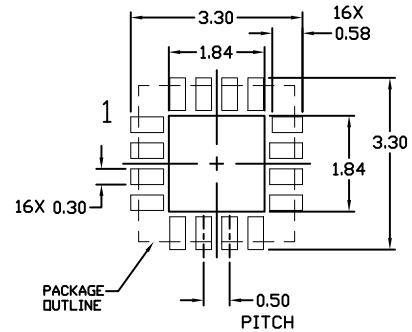

GENERIC MARKING DIAGRAM*

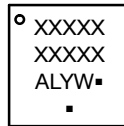

- XXXXX = Specific Device Code
- A = Assembly Location
- L = Wafer Lot
- Y = Year
- W = Work Week
- = Pb-Free Package

(Note: Microdot may be in either location)

*This information is generic. Please refer to device data sheet for actual part marking. Pb-Free indicator, "G" or microdot "▪", may or may not be present. Some products may not follow the Generic Marking.

DOCUMENT NUMBER:	98AON04795D	Electronic versions are uncontrolled except when accessed directly from the Document Repository. Printed versions are uncontrolled except when stamped "CONTROLLED COPY" in red.
DESCRIPTION:	QFN16 3X3, 0.5P	PAGE 1 OF 1

onsemi and ONSEMI are trademarks of Semiconductor Components Industries, LLC dba onsemi or its subsidiaries in the United States and/or other countries. onsemi reserves the right to make changes without further notice to any products herein. onsemi makes no warranty, representation or guarantee regarding the suitability of its products for any particular purpose, nor does onsemi assume any liability arising out of the application or use of any product or circuit, and specifically disclaims any and all liability, including without limitation special, consequential or incidental damages. onsemi does not convey any license under its patent rights nor the rights of others.

onsemi, **Onsemi**, and other names, marks, and brands are registered and/or common law trademarks of Semiconductor Components Industries, LLC dba "**onsemi**" or its affiliates and/or subsidiaries in the United States and/or other countries. **onsemi** owns the rights to a number of patents, trademarks, copyrights, trade secrets, and other intellectual property. A listing of **onsemi**'s product/patent coverage may be accessed at www.onsemi.com/site/pdf/Patent-Marking.pdf. **onsemi** reserves the right to make changes at any time to any products or information herein, without notice. The information herein is provided "as-is" and **onsemi** makes no warranty, representation or guarantee regarding the accuracy of the information, product features, availability, functionality, or suitability of its products for any particular purpose, nor does **onsemi** assume any liability arising out of the application or use of any product or circuit, and specifically disclaims any and all liability, including without limitation special, consequential or incidental damages. Buyer is responsible for its products and applications using **onsemi** products, including compliance with all laws, regulations and safety requirements or standards, regardless of any support or applications information provided by **onsemi**. "Typical" parameters which may be provided in **onsemi** data sheets and/or specifications can and do vary in different applications and actual performance may vary over time. All operating parameters, including "Typicals" must be validated for each customer application by customer's technical experts. **onsemi** does not convey any license under any of its intellectual property rights nor the rights of others. **onsemi** products are not designed, intended, or authorized for use as a critical component in life support systems or any FDA Class 3 medical devices or medical devices with a same or similar classification in a foreign jurisdiction or any devices intended for implantation in the human body. Should Buyer purchase or use **onsemi** products for any such unintended or unauthorized application, Buyer shall indemnify and hold **onsemi** and its officers, employees, subsidiaries, affiliates, and distributors harmless against all claims, costs, damages, and expenses, and reasonable attorney fees arising out of, directly or indirectly, any claim of personal injury or death associated with such unintended or unauthorized use, even if such claim alleges that **onsemi** was negligent regarding the design or manufacture of the part. **onsemi** is an Equal Opportunity/Affirmative Action Employer. This literature is subject to all applicable copyright laws and is not for resale in any manner.

ADDITIONAL INFORMATION

TECHNICAL PUBLICATIONS:

Technical Library: www.onsemi.com/design/resources/technical-documentation
onsemi Website: www.onsemi.com

ONLINE SUPPORT: www.onsemi.com/support

For additional information, please contact your local Sales Representative at www.onsemi.com/support/sales