



PART NAME

# DPS SERIES ENCLOSURE

PART No.

## DPS-28729 & DPS-28729-C

REVISION DATE

4/4/23

### NOTES:

- MATERIAL AND FLAMMABILITY RATING.  
BODY -PC LIGHT GRAY POLYCARBONATE - UL94-5VA  
COVER - PC LIGHT GRAY POLYCARBONATE - UL94-5VA  
CLEAR COVER (C) - PC CLEAR POLYCARBONATE - UL94-V0 AND TESED TO PASS 5VA PER UL746C
- FOLLOW ENCLOSED INSTRUCTION FOR UL COMPLIANCE.: BOXES UL LISTED NEMA TYPE 1, 2, 3, 3R, 4, 4X, 5, 6, 6P 12, 13. DESIGNED MEETS IP65, IP66, IP67, IP68 REQUIREMENTS. UV RESISTANT FOR OUT DOOR USE.
- OPERATING TEMPERATURE IS -35 TO 110C.
- PRE INSTALLED SILICONE GASKET IN COVER
- SCREW CLOSE LID
- BOX COMES WITH 4 UNINSTALLED MOUNTING BRACKETS AND HARDWARE (DPX-100)
- OPTIONAL ACCESSORIES:
  - HINGE AND PANEL SUPPENSION KIT (DPX-444KIT)
  - 12" FLANGE KIT (2 FLANGES + 4 SCREWS) (DPX-1224KIT)
  - FLOATING INTERNAL MOUNTING PANEL (DPX-287294)
  - HINGED INTERNAL MOUNTING PANEL (DPX-287292)
  - COVER MOUNTING PANEL (DPX-287293)
  - BASE INTERNAL MOUNTING PANEL (DPX-287291)
- DIMENSIONS ARE INCH

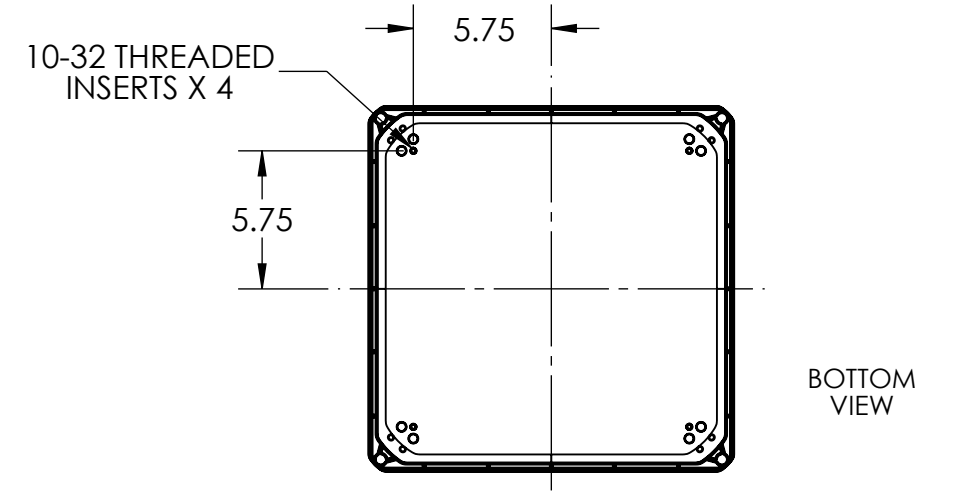
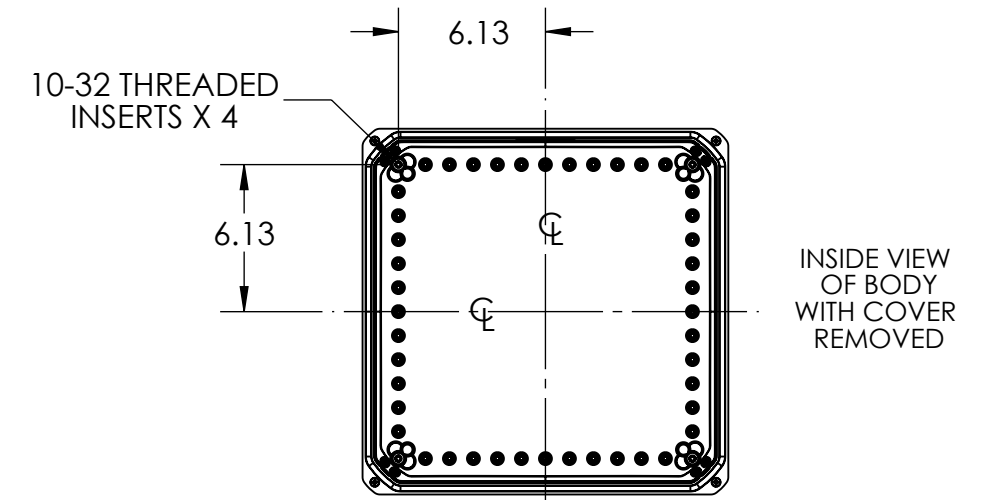
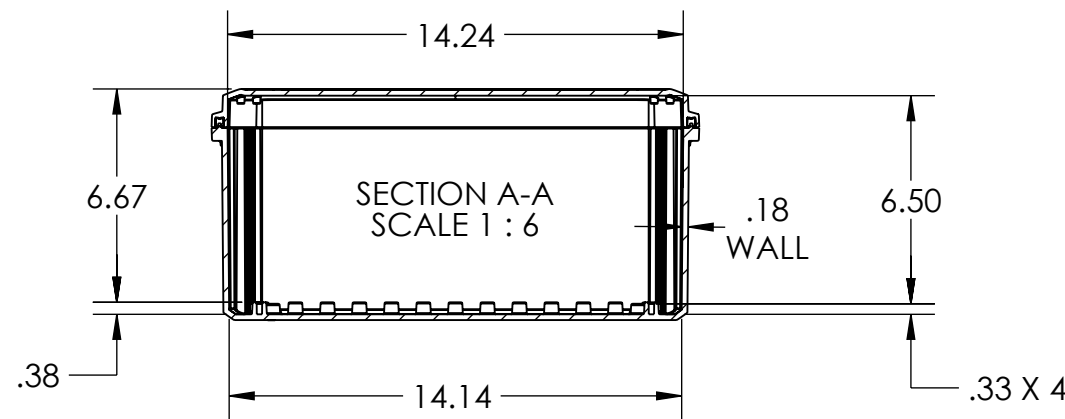
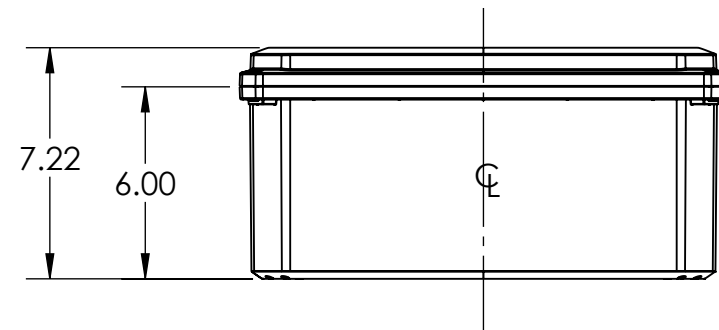
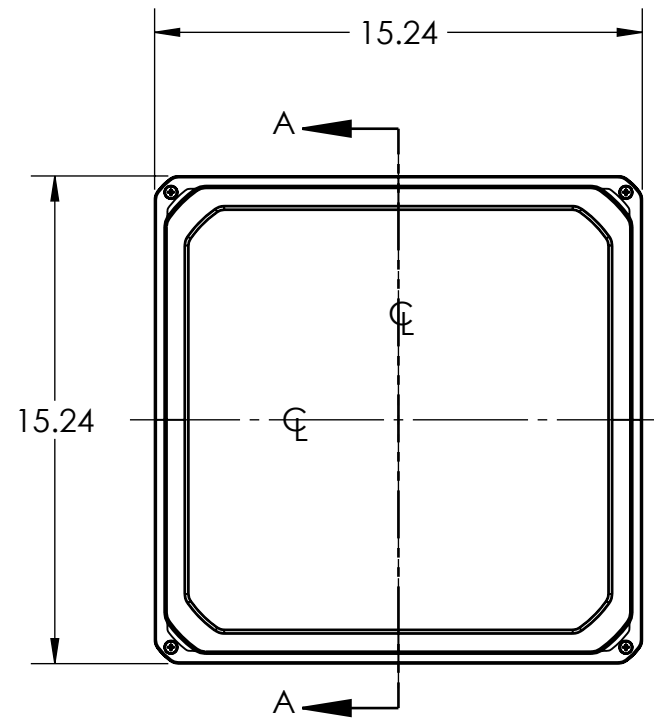
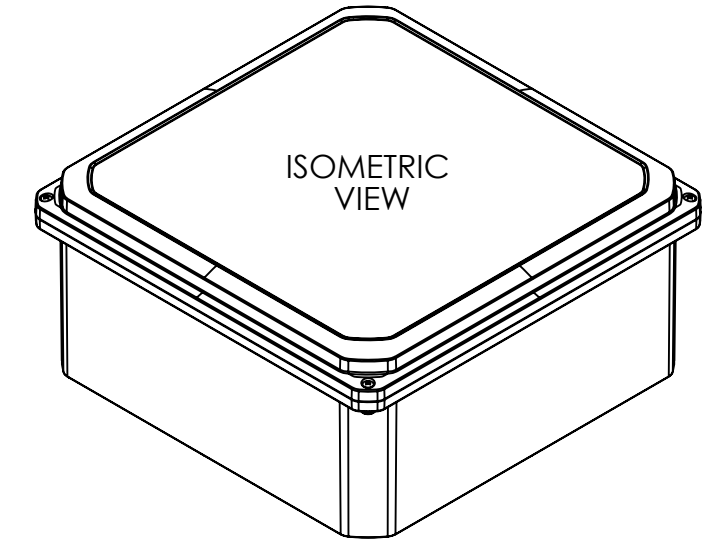

**DRAWING FOR REFERENCE**  
 WE RESERVE THE RIGHT TO MAKE CHANGES TO OUR STANDARD PRODUCTS. PLEASE CONSULT WITH BUD INDUSTRIES PRIOR TO USING THIS DRAWING FOR DESIGN PURPOSE.