

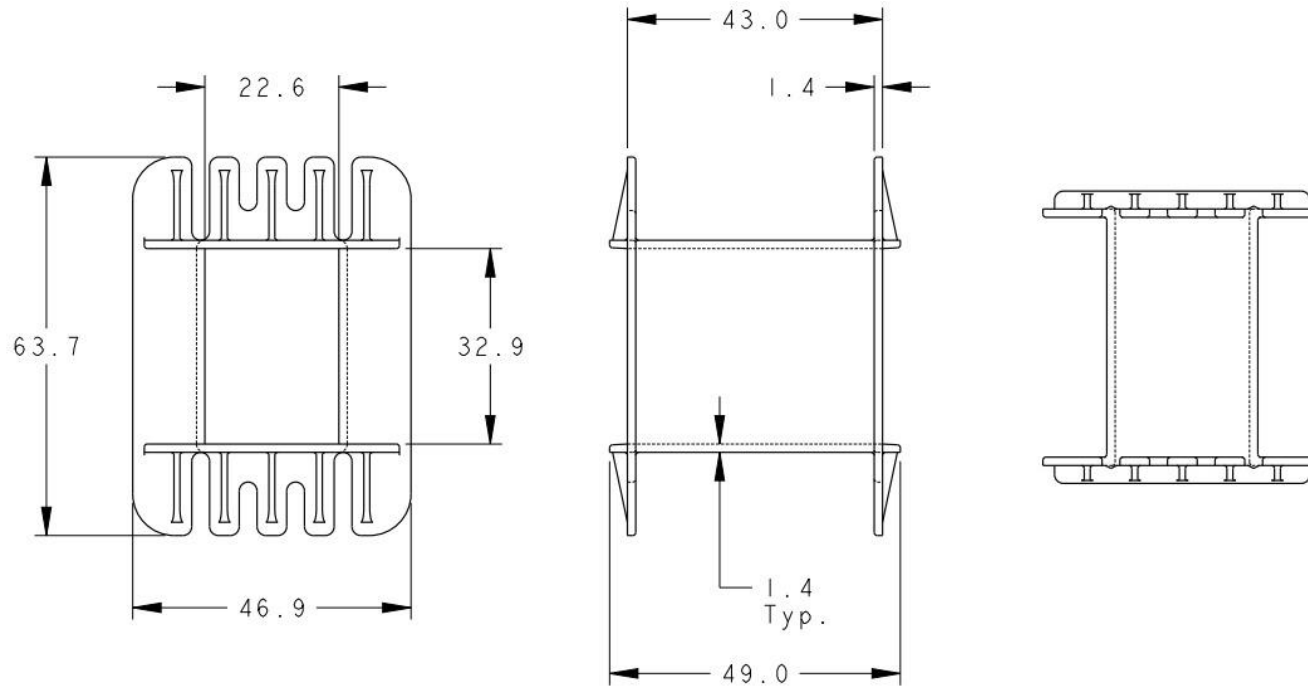

FE0390



Part Number FE0390	Part Weight (g) 20.6	Carton Quantity 256	Pinning Configuration n/a
Order Code FE0390FR3BLK	Material Rynite FR530L	Carton Size (mm) 465x315x260	Pin Length n/a
Part Description Bobbin E70/33/32 V OP 1x Stack	Material Datasheets	Related Items FE0400, FE0410	Terminal Pin Material n/a
Product Range E/EF Range	UL Rating UL94V0	3D CAD Image	Compliance information

MILES - PLATTS

+44 (0)116 264 3850

milesplatts.co.uk

enquiries@milesplatts.co.uk