

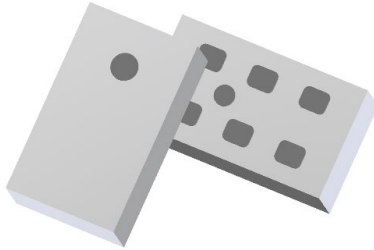

**Ultra Small Low Profile 0603 Balun
50Ω to 200Ω Balanced**



Description:

The BD2326L50200AHF2 is an ultra-small (0603), low profile, balanced to unbalanced transformer in an easy to use Xinger style manufacturing friendly surface mount package. The BD2326L50200AHF2 is ideal for high volume manufacturing and is higher performance, with improved CTE compatibility to commonly used PCB's than traditional ceramic baluns. The BD2326L50200AHF2 has an unbalanced port impedance of 50Ω and a 200Ω balanced port impedance which is ideal for high-level integrations in the following markets: 5G, ISM and S-Band Mil-Aero. This transformation enables single ended signals to be applied to differential ports on RFSOC's and integrated RF chipsets. The output ports have equal amplitude (-3dB) with 180 degree phase differential. The BD2326L50200AHF2 is available on tape and reel for pick and place high volume manufacturing.

All of the Xinger components are constructed from ceramic filled PTFE composites which possess excellent electrical and mechanical stability. All parts have been subjected to rigorous Xinger qualification testing and units are 100% RF tested.

Features:

- 2300 – 2700 MHz
- 0.61mm Height Profile
- 50 Ohm to 2 x 100 Ohm
- 5G, ISM & S-Band
- Low Insertion Loss
- Input to Output DC Isolation
- Surface Mountable
- Tape & Reel
- Non-conductive Surface
- RoHS Compliant
- Halogen Free

Electrical Specifications*:

Parameter (@25°C)	Min	Typ	Max	Min	Typ	Max	Unit
Frequency	2300		2600	2300		2700	MHz
Unbalanced Port Impedance		50			50		Ω
Balanced Port Impedance		200			200		Ω
Return Loss	12	18		11	16		dB
Insertion Loss		0.9	1.1		0.9	1.2	dB
Amplitude Balance		0.4	0.8		0.4	0.8	dB
Phase Balance		3	9		3	10	Degree s
CMRR		29			27		dB
Power Handling @ 85°C			2			2	Watts
Operating Temperature	-55		+140	-55		+140	°C

*Specifications subject to change without notice.

Outline Drawing:

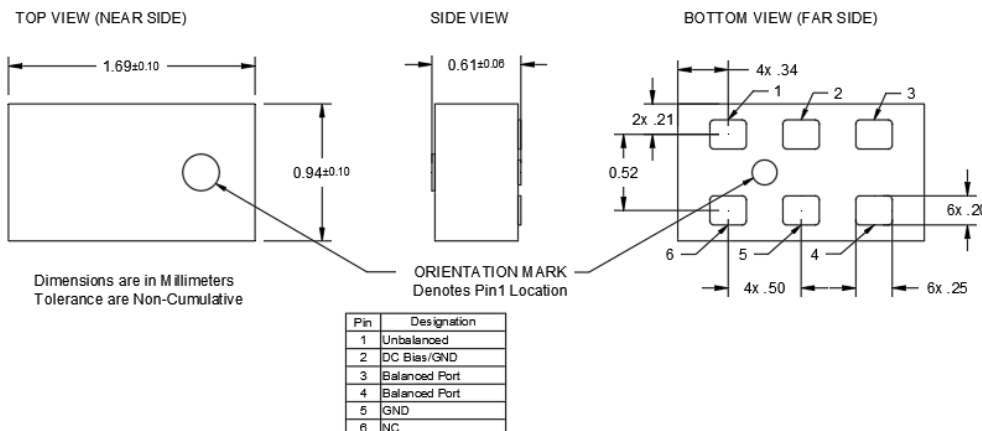

Insertion Loss and Power Derating Curves:

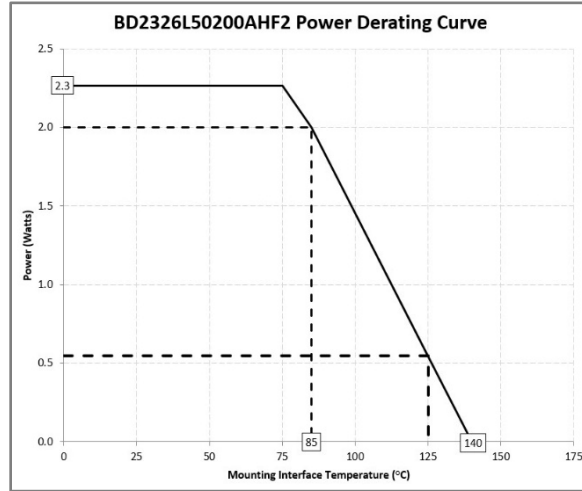
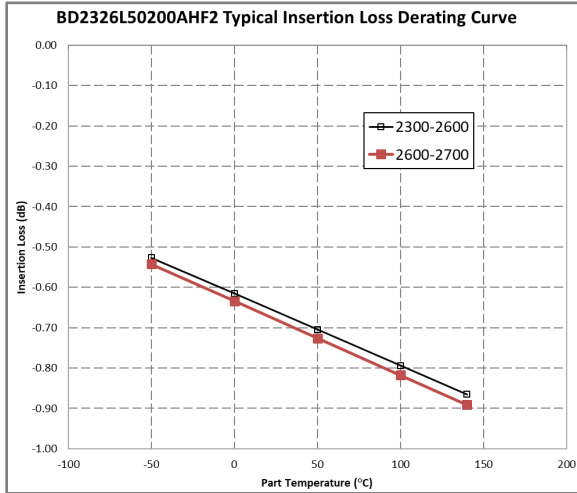

Insertion Loss Derating:

The insertion loss, at a given frequency, of the balun is measured at 25°C and then averaged. The measurements are performed under small signal conditions (i.e. using a Vector Network Analyzer). The process is repeated at temperatures from -55 to 140°C. A best-fit line for the measured data is computed and then plotted from -55°C to 140°C.

Power Derating:

The power handling and corresponding power derating plots are a function of the thermal resistance, mounting surface temperature (base plate temperature), maximum continuous operating temperature of the balun, and the thermal insertion loss. The thermal insertion loss is defined in the Power Handling section of the data sheet.

As the mounting interface temperature approaches the maximum continuous operating temperature, the power handling decreases to zero.

If mounting temperature is greater than 85°C, the Xinger balun will perform reliably as long as the input power is derated to the curve above.

Typical Performance: 2000 MHz to 3000 MHz

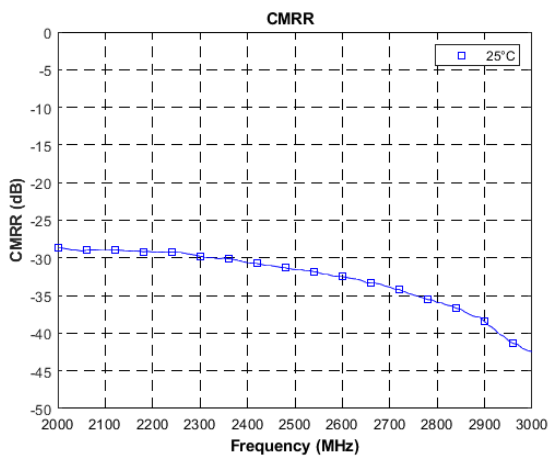
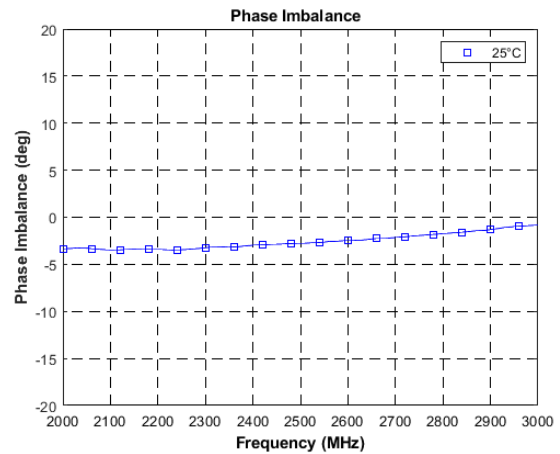
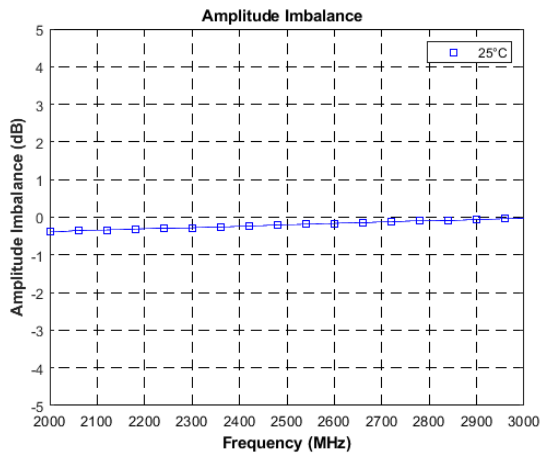
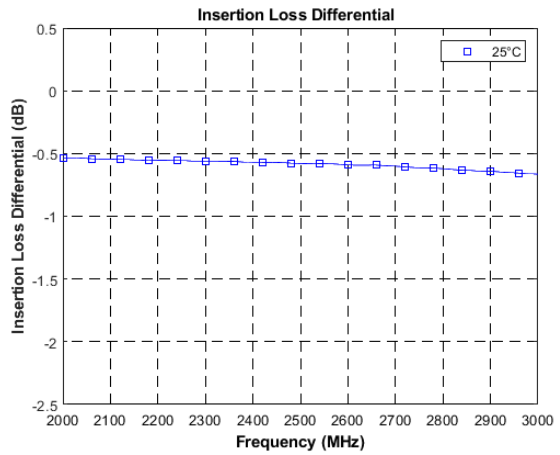
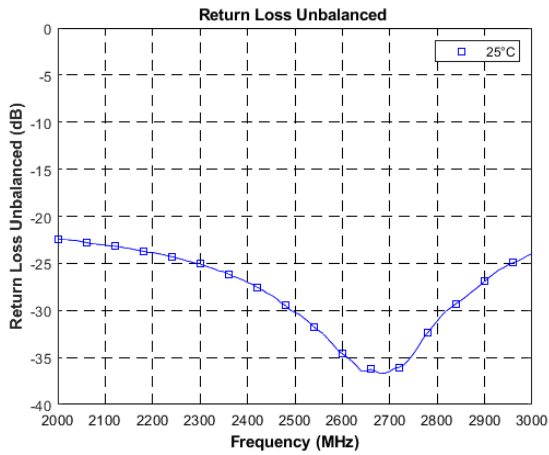

Definition of Measured Specifications:

Parameter	Definition	Mathematical Representation
Return Loss	The impedance match at the single ended port.	$RL = 20Log_{10}(S_{11})$
Differential Port Return Loss	The impedance match at the differential port.	$RLD = 20Log_{10} 0.5 * (S_{22} - S_{23} - S_{32} + S_{33}) $
Insertion Loss	Power loss from common mode to differential mode.	$ILD = 20Log_{10}(0.707 * (S_{21} - S_{31}))$
Phase Imbalance	The difference in phase angle between the two differential ports, offset by 180 deg.	$PB = (Phase(S_{21}) - Phase(S_{31})) - 180^{\circ}$
Amplitude Imbalance	The ratio of the power at differential ports.	$AB = 20Log_{10} \frac{S_{21}}{S_{31}} $
Common Mode Rejection Ratio	The ratio of powers of the differential gain to the common-mode gain.	$CMRR = \pm 20Log_{10}(S_{21}+S_{31})/(S_{21}-S_{31})$

*Parts are 100% RF tested as per spec definition. Refer to page 1 for ports/pin assignments

Peak Power Handling:

High-Pot testing of these components during the qualification procedure resulted in a minimum breakdown voltage of 1Kv (minimum recorded value). This voltage level corresponds to a breakdown resistance capable of handling at least 12dB peak over average power levels, for very short durations. The breakdown location consistently occurred between the pads. The breakdown levels at these points will be affected by any contamination in the gap area around these pads. These areas must be kept clean for optimum performance. It is recommended that the user test for voltage breakdown under the maximum operating conditions and over worst case modulation induced power peaking. This evaluation should also include extreme environmental conditions (such as high humidity).

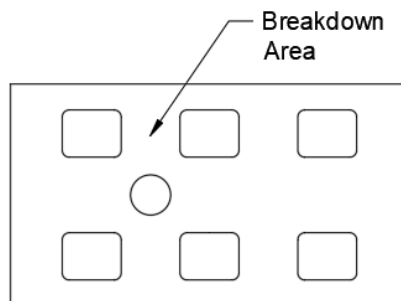

Packaging and Ordering Information:

Parts are available in reel and are packaged per EIA 481. Parts are oriented in tape and reel as shown below. Minimum order quantities are 4000 per reel.

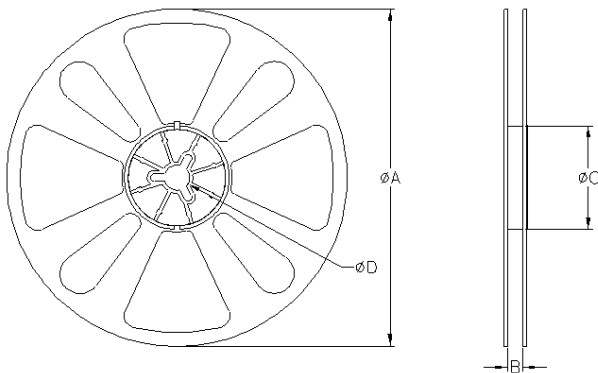
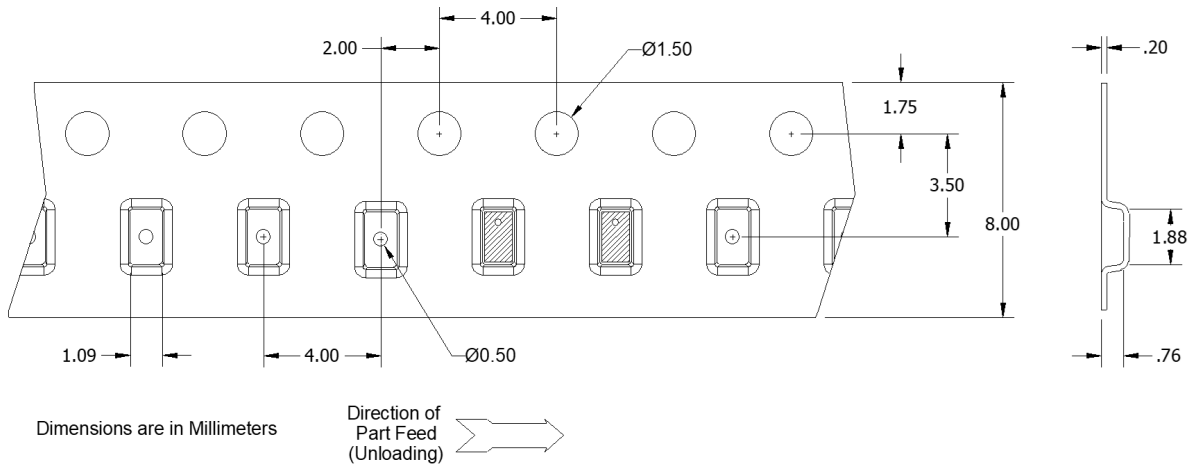

TABLE 1		
QUANTITY/REEL	REEL DIMENSIONS mm	
4000	øA	177.80
	B	8.00
	øC	50.80
	øD	13.00

Contact us:
rf&s_support@ttm.com