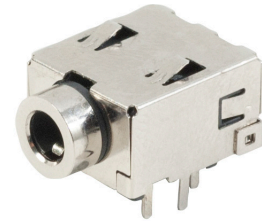
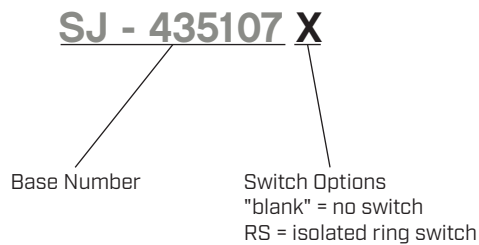

SERIES: SJ-435107 | **DESCRIPTION:** AUDIO JACK**FEATURES**

- grounded spring tabs
- shielded
- metal bushing

**PART NUMBER KEY****SPECIFICATIONS**

parameter	conditions/description	min	typ	max	units
rated input voltage			12		Vdc
rated input current				1.0	A
contact resistance	between terminal and mating plug between terminal in a closed circuit			50 30	mΩ mΩ
insulation resistance		100			MΩ
voltage withstand	for 1 minute			500	Vac
insertion/withdrawal force		0.3		3	kg
operating temperature		-25		85	°C
life			5,000		cycles
flammability rating	UL94V-0				
RoHS	yes				

SOLDERABILITY

parameter	conditions/description	min	typ	max	units
wave soldering	dipped in solder pot for 5 ±0.5 seconds at	255	260	265	°C

MECHANICAL DRAWING

units: mm
 tolerance:
 X.X ±0.20 mm
 X.XX ±0.10 mm
 X.XXX ±0.050 mm
 PCB: ±0.05 mm

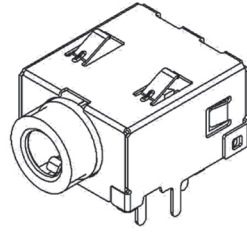

DESCRIPTION	MATERIAL	PLATING/COLOR
terminal [1-6]	copper alloy	tin
shield	copper alloy	nickel
bushing	brass	nickel
housing	PA66 [UL94V-0]	black

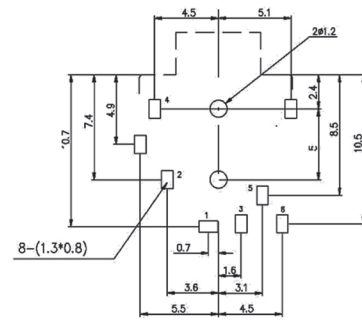
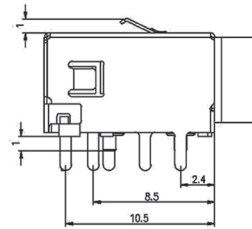
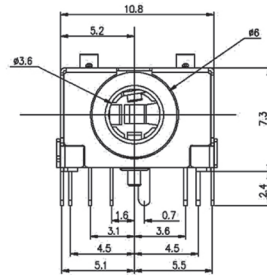
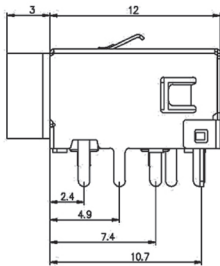
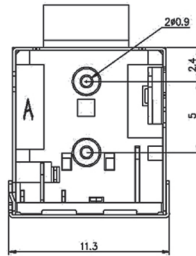

Recommended PCB Layout
Top View

Model No.	SJ-435107	SJ-435107RS
Schematic		
PIN		
1	sleeve	sleeve
2	tip	tip
3	ring 1	ring 1
4	ring 2	ring 2
5	NP	isolated ring 1
6	NP	isolated ring 1 switch [N-O]

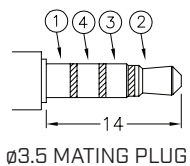

REVISION HISTORY

rev.	description	date
1.0	initial release	02/23/2012
1.01	updated schematic and spec	06/07/2012
1.02	added drawing dimension, updated spec	01/03/2014
1.03	brand update	10/09/2019
1.04	product reengineered for improved manufacturability and production yield, see PCN for details	06/01/2023

The revision history provided is for informational purposes only and is believed to be accurate.



CUI Devices offers a one (1) year limited warranty. Complete warranty information is listed on our website.

CUI Devices reserves the right to make changes to the product at any time without notice. Information provided by CUI Devices is believed to be accurate and reliable. However, no responsibility is assumed by CUI Devices for its use, nor for any infringements of patents or other rights of third parties which may result from its use.

CUI Devices products are not authorized or warranted for use as critical components in equipment that requires an extremely high level of reliability. A critical component is any component of a life support device or system whose failure to perform can be reasonably expected to cause the failure of the life support device or system, or to affect its safety or effectiveness.

cuidevices.com