



# High Precision chip attenuators (Up to 55GHz)

## ■ATS-FD series

### Features

- Attenuation range up to 55GHz
- Internal circuit specially designed for 0-10dB attenuation.
- Miniature surface mount chip attenuator (1005,2012 size)
- Signal line sandwiched by ground – excellent heat dissipation and low noise.

### Applications

- Wireless communication devices and base stations
- Wireless communication modules



## ◆Part numbering system

### ATS 2012 - 10DB - FD - T1

Series Code

Size : 1005, 2012

Packing quantity :  
T1 (1,000pcs) , T05 (500pcs)

Face down mounting

Attenuation

## ◆Electrical Specification

Type	ATS1005-FD		ATS2012-FD		
	Attenuation	0dB	1~10dB	0dB	1~8dB
Circuit Type	Thru	Pi( $\pi$ )	Thru	Pi( $\pi$ )	Dual Pi ( Dual $\pi$ )
Equivalent circuits	①	②	①	②	③
Attenuation tolerance	$\pm 0.75$ (DC ~ 25GHz), $\pm 1.25$ dB(25 ~ 40GHz), $\pm 2.50$ dB(40 ~ 55GHz)				
V S W R	$\leq 1.40$ (DC ~ 25GHz), $\leq 1.60$ (25 ~ 40GHz), $\leq 1.80$ (40 ~ 55GHz)				
Impedance	50 $\Omega$				
Operating frequency	DC~55GHz		DC~55GHz		
Rated power	32mW		100mW		
Rated operating temperature	70°C				
Operating temperature	-40°C~+125°C				
Packaging quantity	500pcs/reel(T05) 1,000pcs/reel(T1)				

## ◆Equivalent Circuit and pin arrangement

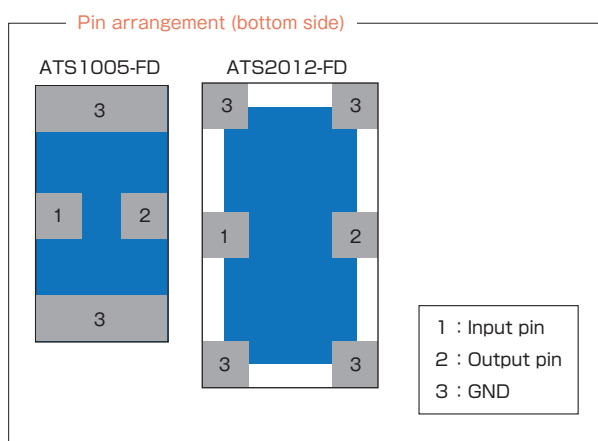
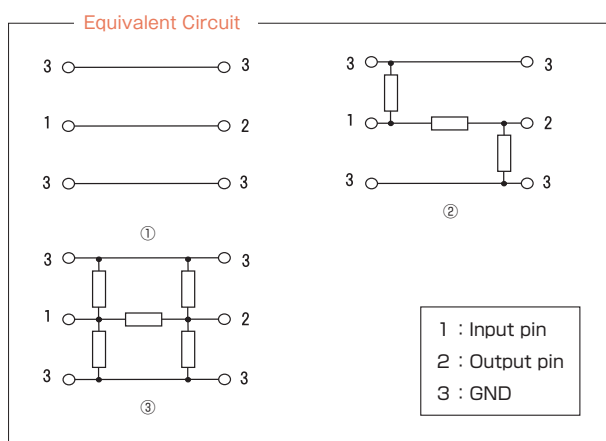

## ◆ Dimensions

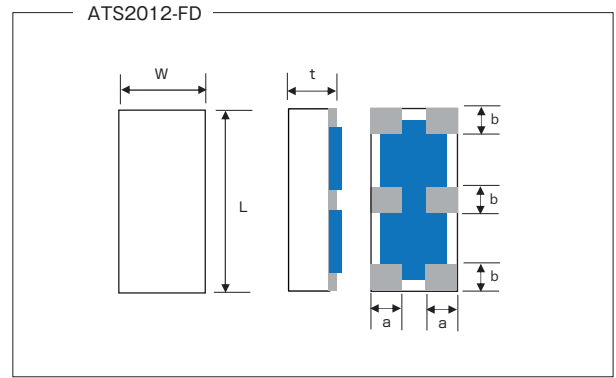
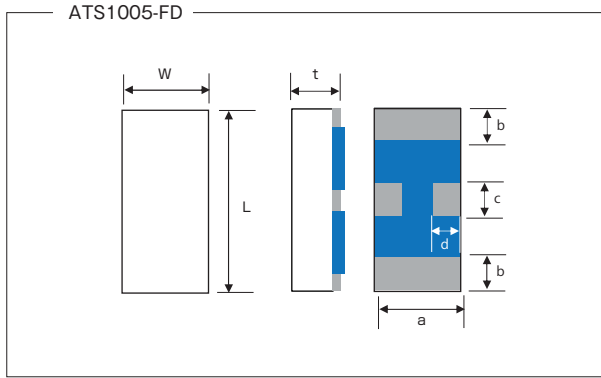

Type	Size (inch)	L	W	t	a	b	c	d
ATS1005-FD	0402	1.00±0.10	0.50±0.10	0.32±0.05	0.44±0.05	0.15±0.05 0.10±0.05*1	0.20±0.05	0.15±0.05
ATS2012-FD	0805	2.00±0.20	1.25±0.20	0.22±0.05	0.35±0.10	0.25±0.10	—	—

(unit : mm)

\*1: Applies to ATS1005-01DB-FD

## ◆ Recommended land patterns(soldering footprints)

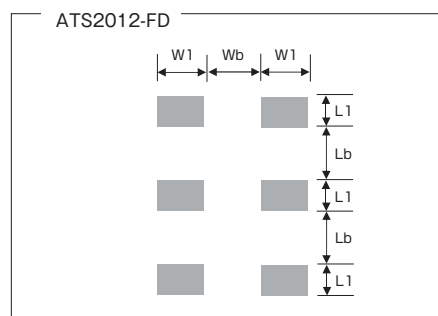
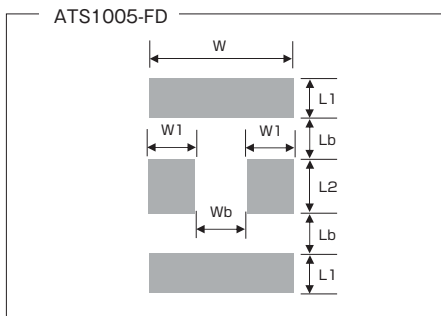

Type	W	W1	Wb	L1	Lb	L2
ATS1005-FD	0.44	0.15	0.14	0.15	0.22	0.20
ATS2012-FD	—	0.35	0.49	0.25	0.60	—

(unit : mm)

## ◆ Derating Curve

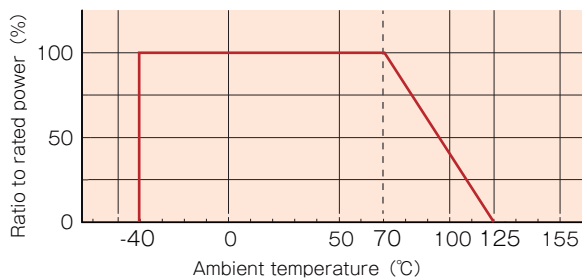

## ◆ High frequency characteristics

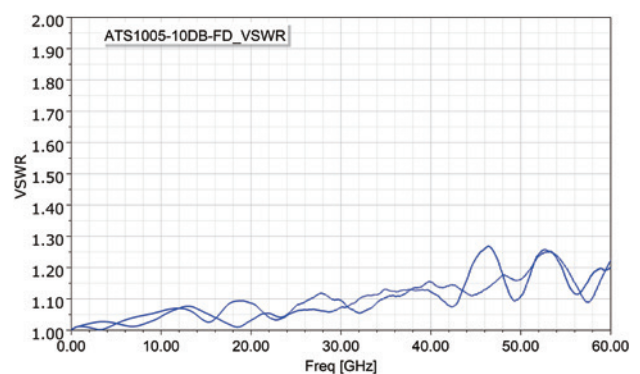
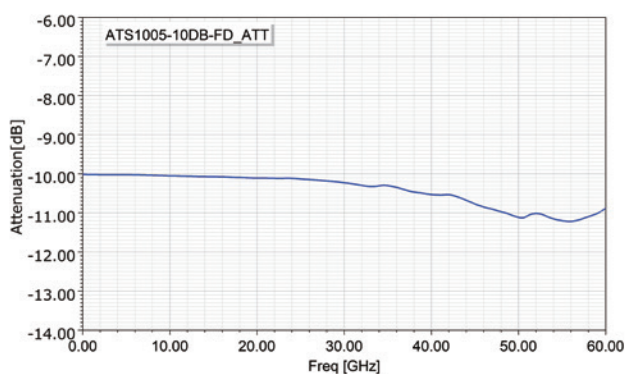
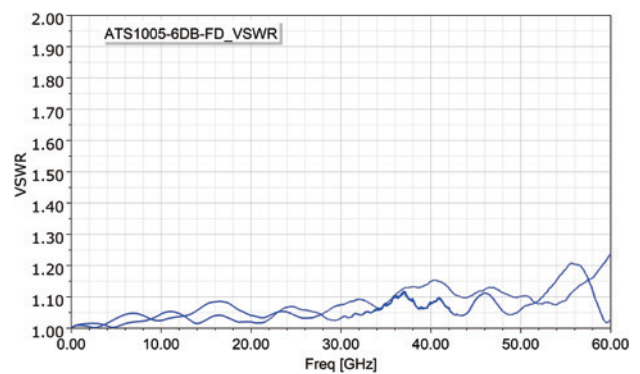
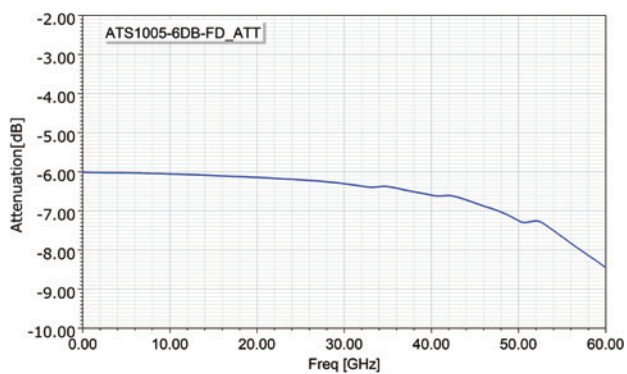
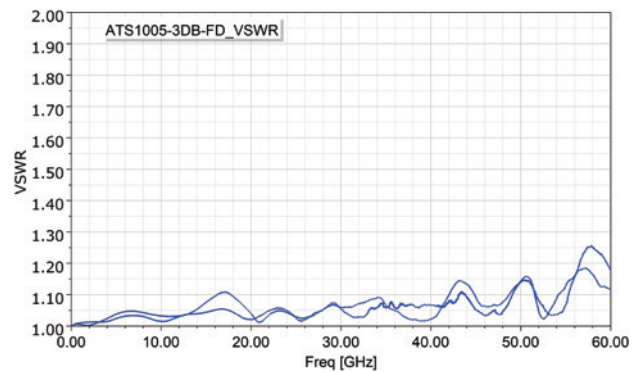
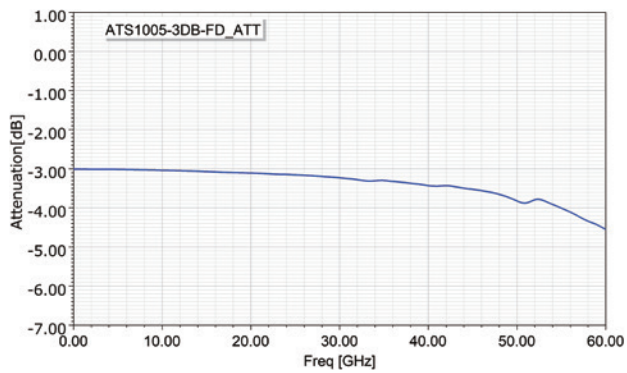
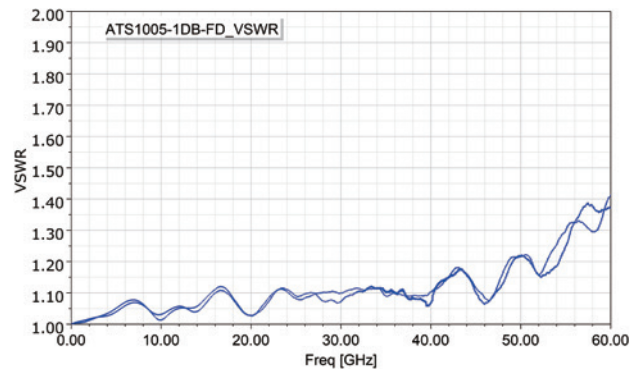
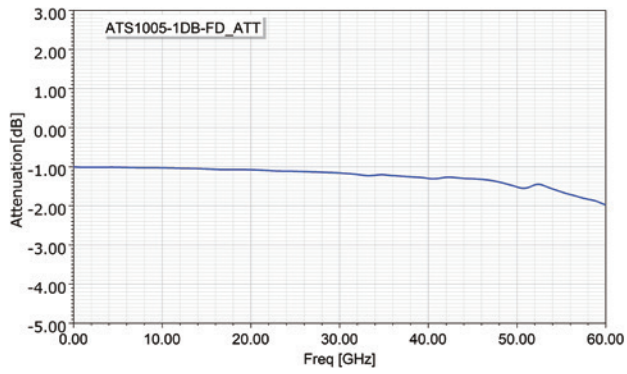
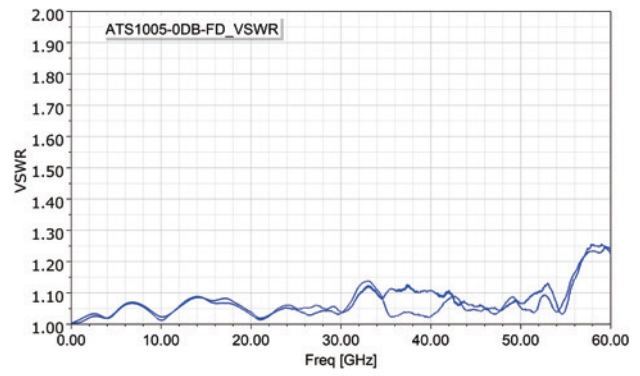
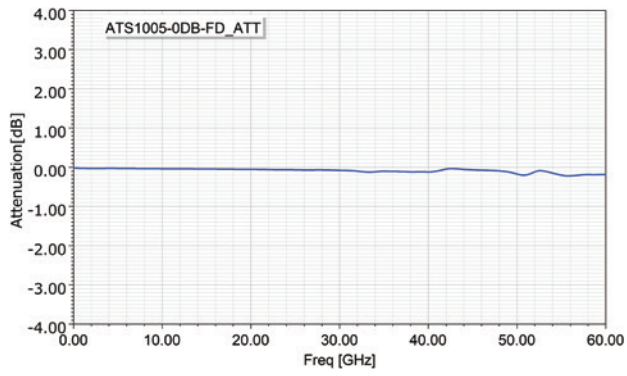

High frequency surface mount components

ATS-FD series

## ◆ High frequency characteristics

