



9 dB Fixed Attenuator, 4.3-10 Male to 4.3-10 Female
Rated to 2 Watts Up to 6 GHz

RF Fixed Attenuators Technical Data Sheet

PE7451-9

Features

- DC to 6 GHz Frequency Range
- 4.3-10 Connectorized Design
- Attenuation 9 dB \pm 0.5 dB
- Max Power 2 Watts (CW)
- Typical VSWR of 1.3:1

Applications

- Instrumentation
- Precision Measurements
- Prototyping and Characterization
- Production Systems

Description

Pasternack carries a wide range of fixed attenuators with a broad selection of attenuation levels, frequency ranges, and power dissipation ranges. RF microwave attenuators (also known as RF pads) lower the amplitude of a signal (attenuate) a known amount and can be used in a wide variety of applications. These attenuator pads are used when a signal needs to be reduced to protect measurement equipment or other circuitry, to extend the range of power meters and amplifiers, and to impedance match circuits by reducing the VSWR seen by adjacent components. RF attenuators can prevent signal overload in amplifiers, receivers and detectors, adjusting the signal level to a range that is optimal.

Few RF components are as commonly used as fixed coaxial attenuators, and Pasternack carries one of the largest in-stock varieties and ships them same day. The 9 dB Fixed Attenuator PE7451-9 is rated to 2 Watts and operates from DC to 6 GHz. The versatile coaxial package uses 4.3-10 male to 4.3-10 female connectors and is also REACH compliant.

Electrical Specifications

Description	Minimum	Typical	Maximum	Units
Frequency Range	DC		6	GHz
Impedance		50		Ohms
Nominal Attenuation		9		dB
Attenuation Accuracy			\pm 0.5	dB
VSWR			1.3:1	
Input Power, CW			2	Watts
Input Power, Peak 5 μ s PW, 0.4% duty cycle			500	Watts

Click the following link (or enter part number in "SEARCH" on website) to obtain additional part information including price, inventory and certifications: [9 dB Fixed Attenuator, 4.3-10 Male to 4.3-10 Female Rated to 2 Watts Up to 6 GHz PE7451-9](#)



9 dB Fixed Attenuator, 4.3-10 Male to 4.3-10 Female
Rated to 2 Watts Up to 6 GHz

RF Fixed Attenuators Technical Data Sheet

PE7451-9

Mechanical Specifications

Size

Length	2.874 in [73 mm]
Width/Diameter	0.709 in [18.01 mm]
Height	0.709 in [18.01 mm]
Weight	0.5 lbs [226.8 g]
Body Material and Plating	Brass, Nickel

Configuration

Design	Fixed
Package Style	Connectorized

Connectors

Description	Connector 1	Connector 2
Type	4.3-10 Male	4.3-10 Female
Contact Material and Plating	Brass, Gold	Beryllium Copper, Gold
Body Material and Plating	Brass, Nickel	Brass, Nickel

Environmental Specifications

Temperature

Operating Range	-55 to +125 deg C
Storage Range	-55 to +125 deg C

Compliance Certifications (see [product page](#) for current document)

Plotted and Other Data

Notes:

9 dB Fixed Attenuator, 4.3-10 Male to 4.3-10 Female Rated to 2 Watts Up to 6 GHz from Pasternack Enterprises has same day shipment for domestic and International orders. Our RF, microwave and millimeter wave products maintain a 99.4% availability and are part of the broadest selection in the industry.

Click the following link (or enter part number in "SEARCH" on website) to obtain additional part information including price, inventory and certifications: [9 dB Fixed Attenuator, 4.3-10 Male to 4.3-10 Female Rated to 2 Watts Up to 6 GHz PE7451-9](#)

URL: <https://www.pasternack.com/9db-fixed-4.3-10-male-4.3-10-female-2-watts-attenuator-pe7451-9-p.aspx>

PE7451-9 CAD Drawing

9 dB Fixed Attenuator, 4.3-10 Male to 4.3-10 Female Rated to 2 Watts Up to 6 GHz

REVISIONS			
REV.	DESCRIPTION	DATE	APPROVED
A	INITIAL RELEASE	12/23/2022	SPONG

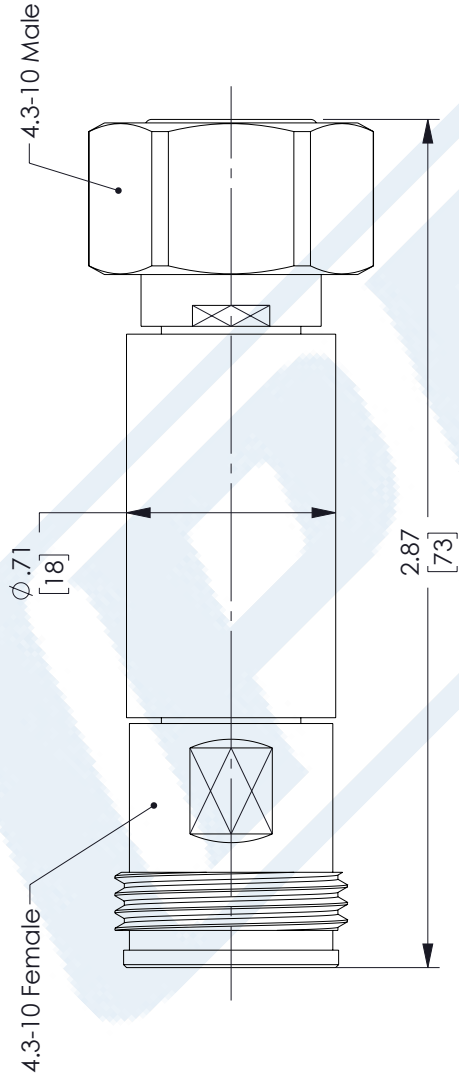

UNLESS OTHERWISE SPECIFIED
LEADING DIMENSIONS ARE INCHES
DIMENSIONS IN [] ARE MILLIMETERS

TOLERANCES:

.X = ±.2	[5.08]	FRACTIONS
.XX = ±.02	[.51]	± 1/32
.XXX = ±.005	[.13]	ANGLES ± 1°

CABLE LENGTH (L) TOLERANCES:

L ≤ 12	[305]	= +1 [25] / -0
12 [305] < L ≤ 60	[1524]	= +2 [51] / -0
60 [1524] < L ≤ 120	[3048]	= +4 [102] / -0
120 [3048] < L ≤ 300	[7620]	= +6 [152] / -0
300 [7620] < L		= +5%L / -0

ALL DIMENSIONS SHOWN
ARE FOR REFERENCE ONLY.

PE PASTERNAK
an INFINITI® brand

Pasternack Enterprises, Inc.
P. O. Box 16759, Irvine, CA 92623.
Phone: 1.949.261.1920 | 1.866.727.8376
Fax: 1.949.261.7451
Website: www.pasternack.com
E-mail: sales@pasternack.com

SIZE A CAGE CODE 53919 DRAWN BY PSRINIVAS ITEM NO. PE7451-9 REV A

THIRD-ANGLE PROJECTION

THE INFORMATION AND
DESIGN IN THIS DOCUMENT
IS THE PROPERTY OF
PASTERNAK CORPORATION
ALL RIGHTS RESERVED.

SHEET 1 OF 1
SCALE N/A